

Bremshydraulik

Hydraulic Components

2024

Bremsen-Ersatzteilprogramm

Brake Parts Program



Brakethrough Technology



Erstklassig First-class

Besser ist besser

Wenn es um Qualität geht, genügt uns ein „sehr gut“ noch lange nicht. Wir erfüllen hohe Ansprüche an das Qualitätsmanagement und die europäische Sicherheitsnorm ECE-R90 wird von ATE sogar übertroffen. Zudem führen wir zahlreiche zusätzliche Tests durch, unter anderem zu Verschleiß und Wärmeleistung.

Auch Nachhaltigkeit ist uns wichtig: Wir stellen die Mischungen für ATE Bremsbeläge auf kupferfreie Materialien um und setzen bei ATE Ceramic auf geringen Abrieb. Nutzen ausschließlich umweltfreundliches Material für die Beschichtung von Bremsscheiben. Und bereiten Produkte wie Bremsattel wieder auf.

Better is better

When it comes to quality, “very good” is simply not good enough for us. We meet high standards of quality management – and ATE even exceeds the European safety standard ECE-R90. We also perform many additional tests, including wear and thermal performance.

Sustainability is also important to us: we convert the compounds for ATE brake pads to copperfree materials and opt for low abrasion with ATE Ceramic. We only use environmentally friendly material for the coating of brake discs – and we remanufacture products like brake callipers.

Höchste Qualität für optimale Leistung.



SUPER DOT 5.1

Der Premium-Allrounder ATE SUPER DOT 5.1 mit bester Funktionalität bei heißen wie kalten Einsatzbedingungen: 5 °C höherer Nass-Siedepunkt und höheres Wechselintervall als ATE SL.6 bei gleich guter Viskosität, ideal für Fahrzeuge mit modernen Fahrerassistenzsystemen wie ESP®, ABS und ASR.

Große Auswahl für alle Einsatzgebiete

- | ATE SL als bewährter DOT 4-Typ, ATE TYP 200 für Rennsportbegeisterte und ATE DOT 3 Blau für Oldtimer und Fahrzeuge, wo die Verwendung einer DOT 3-Flüssigkeit vom Fahrzeughersteller vorgeschrieben ist
- | ATE SL.6 ist optimal für ESP®, ABS und ASR: dünnflüssig auch bei niedrigen Temperaturen, schnelle Reaktionszeit
- | Siedepunkte und Viskosität übertreffen gesetzliche und technische Anforderungen
- | Schutz vor Korrosion durch hochwertige Additive

Die Eigenschaften von ATE Bremsflüssigkeiten

	Siedepunkt	Nass-Siedepunkt	Viskosität bei -40 °C	Wechselintervall
ATE SUPER DOT 5.1	min. 265 °C	min. 180 °C	max. 750 mm ² /s	bis 3 Jahre
ATE TYP 200 DOT 4 Racing-Qualität	min. 280 °C	min. 198 °C	max. 1.400 mm ² /s	bis 3 Jahre
ATE SL.6 DOT 4 Ideal für ESP®, ABS, ASR	min. 265 °C	min. 175 °C	max. 700 mm ² /s	bis 2 Jahre
ATE SL DOT 4	min. 260 °C	min. 165 °C	max. 1.400 mm ² /s	bis 1 Jahr
ATE DOT 3 Blau	min. 245 °C	min. 150 °C	max. 1.500 mm ² /s	bis 1 Jahr

Zur Erhaltung der Funktionssicherheit der Bremsanlage muss Bremsflüssigkeit entsprechend der vom Fahrzeughersteller vorgegebenen Qualität und in den angegebenen Wechselintervallen ausgetauscht werden.



Servicegeräte

Natürlich bieten wir auch Geräte für Tests, Entlüftung und Entsorgung von Bremsflüssigkeiten an. Sie arbeiten exakt und zuverlässig, sind leicht zu bedienen und technologisch auf dem neuesten Stand.



In unserem Expert Talk stellen wir Ihnen die verschiedenen Bremsflüssigkeiten vor:



Erfahren Sie mehr über ATE Bremsflüssigkeiten auf www.ate.de/bremsfluessigkeit sowie über unsere Servicegeräte auf www.ate-info.de

Typ	ATE Sachnummer	EAN-Nr. 4006633	Gebinde	Paletteneinheit
SUPER DOT 5.1 SAE-Spezifikation, J1704-FMVSS 116/DOT 5.1 ISO-Klasse 5.1 – niedrigviskos	706602 03.9901-6602.2	45757 6	1 l	600 Kannen ²
	706603 03.9901-6603.2	45759 0	5 l	400 Kannen ³
	706611 03.9901-6611.2	45761 3	20 l	36 Kannen
	706620 03-9901-6620-2	48735 1	30 l	22 Kannen
	706614 03-9901-6614-2	48734 4	50 l	12 Kannen
TYP 200 SAE-Spezifikation, J1704-FMVSS 116/DOT 4	706202 03.9901-6202.2	10825 6	1 l	600 Kannen ²
	706203 03.9901-6203.2	12166 8	5 l	400 Kannen ³
	706220 03.9901-6220.2	12780 6	30 l	22 Kannen
SL 6 SAE-Spezifikation, J1704-FMVSS 116/DOT 4 ISO-Klasse 6 – niedrigviskos	706402 03.9901-6402.2	20746 1	1 l	600 Kannen ²
	706403 03.9901-6403.2	20748 5	5 l	400 Kannen ³
	706411 03.9901-6411.2	20750 8	20 l	36 Kannen
	706420 03.9901-6420.2	23120 6	30 l	22 Kannen
	706414 03.9901-6414.2	23005 6	50 l	12 Kannen
	706405 03.9901-6405.2	23121 3	200 l	1 Stück
SL SAE-Spezifikation, J1704-FMVSS 116/DOT 4	705801 03.9901-5801.2	49001 6	1/2 l	1.200 Kannen ¹
	705802 03.9901-5802.2	49002 3	1 l	600 Kannen ²
	705803 03.9901-5803.2	49003 0	5 l	400 Kannen ³
	705811 03.9901-5811.2	29907 7	20 l	12 Kannen
	705820 03.9901-5820.2	10824 9	30 l	22 Kannen
	705814 03.9901-5814.2	10366 4	50 l	12 Kannen
	705805 03.9901-5805.2	49005 4	200 l	1 Stück
BLAU SAE-Spezifikation, J1703-FMVSS 116/DOT 3	700301 03-9901-0301-2	10188 2	1/2 l	1.200 Kannen ¹
	705302 03.9901-0302.2	10190 5	1 l	600 Kannen ²
	705303 03.9901-0304.2	10194 3	12 oz	2.160 Kannen ⁴



Paletteneinheit:

¹20 Kannen je Karton.

²10 Kannen je Karton.

³4 Kannen je Karton.

⁴60 Kannen je Karton.

Abweichende Artikelnummern für Lieferländer außerhalb Deutschlands möglich.

Top quality for optimum performance.



SUPER DOT 5.1

ATE SUPER DOT 5.1 with optimum performance in both hot and cold conditions: 5 °C higher wet boiling point than ATE SL.6, same excellent viscosity, longer change interval, ideal for vehicles with advanced driver assistance systems like ESP®, ABS and ASR.

Wide selection for all applications

- | ATE SL as a proven DOT 4 grade, ATE TYP 200 for racing enthusiasts and ATE DOT 3 Blau for classic cars and vehicles for which the manufacturer specifies a DOT 3 brake fluid
- | ATE SL.6 is optimal for ESP®, ABS and ASR: low viscosity even at low temperatures, with a fast reaction time
- | Boiling points and viscosities are better than in statutory and technical regulations
- | Protection from corrosion by high-grade additives

Properties of ATE brake fluids

	Boiling point	Wet boiling point	Viscosity at -40 °C	Change interval
ATE SUPER DOT 5.1	min. 265 °C/509 °F	min. 180 °C/356 °F	max. 750 mm ² /s	up to 3 years
ATE TYP 200 DOT 4 Racing quality	min. 280 °C/536 °F	min. 198 °C/388 °F	max. 1,400 mm ² /s	up to 3 years
ATE SL.6 DOT 4 Ideal for ESP®, ABS, ASR	min. 265 °C/509 °F	min. 175 °C/347 °F	max. 700 mm ² /s	up to 2 years
ATE SL DOT 4	min. 260 °C/500 °F	min. 165 °C/329 °F	max. 1,400 mm ² /s	up to 1 year
ATE DOT 3 Blau	min. 245 °C/473 °F	min. 150 °C/302 °F	max. 1,500 mm ² /s	up to 1 year

To maintain the operational reliability and safety of the brake system, you must change the brake fluid in accordance with the vehicle manufacturer's recommendations on quality and at the specified change intervals.



Service units

Of course we also offer devices for testing, bleeding and disposing of brake fluids. The devices work accurately and reliably, are easy to use and their technology is state of the art.



In our Expert Talk we introduce you to the different brake fluids:



To learn more about ATE brake fluids go to www.ate-brakes.com/brakefluid. Information on our service units is available at www.ate-info.de/en

Type	ATE item code	Language variations	Container	Pallet unit
SUPER DOT 5.1 SAE specification, J1704-FMVSS 116/DOT 5.1 ISO Class 5.1 – low viscosity	706602 03.9901-6602.2	DE, EN, ES, PT, CN, FR, IT, AR, SE, NL, JP, TH, GR	1 l	600 cans ²
	706612 03.9901-6612.2	PL, RU, CZ, SK, SLO, HU, BG, KA, HR, SR, RO	1 l	600 cans ²
	706603 03.9901-6603.2	DE, EN, ES, PT, CN, FR, IT, AR, SE, NL, JP, TH, GR, PL, RU, CZ, SK, SLO, HU, BG, KA, HR, SR, RO	5 l	400 cans ³
	706611 03.9901-6611.2		20 l	36 cans
	706620 03.9901-6620-2		30 l	22 cans
	706614 03.9901-6614-2		50 l	12 cans
TYP 200 SAE specification, J1704-FMVSS 116/DOT 4	706202 03.9901-6202.2	DE, EN, ES, PT, CN, FR, IT, AR, SE, NL, JP, TH, GR	1 l	600 cans ²
	706212 03.9901-6212.2	PL, RU, CZ, SK, SLO, HU, BG, KA, HR, SR, RO	1 l	600 cans ²
	706203 03.9901-6203.2	DE, EN, PL, ES, CN, FR, IT, RO, AR, SE, RU, HR, SR, CZ, SK, SLO, GR, HU, JP, TH, BG, NL, PT, KA, DK, FI, SQ, TR, LV, NO, LT, MS, HY	5 l	400 cans ³
	706220 03.9901-6220.2	DE, EN, PL, ES, CN, FR, IT, RO, AR, SE, RU, HR, SR, CZ, SK, SLO, GR, HU, JP, TH, BG, NL, PT, KA, DK, FI, SQ, TR	30 l	22 cans
SL 6 SAE specification, J1704-FMVSS 116/DOT 4 ISO Class 6 – low viscosity	706402 03.9901-6402.2	DE, EN, ES, PT, CN, FR, IT, AR, SE, NL, JP, TH, GR	1 l	600 cans ²
	706432 03.9901-6432.2	PL, RU, CZ, SK, SLO, HU, BG, KA, HR, SR, RO	1 l	600 cans ²
	706403 03.9901-6403.2	DE, EN, PL, ES, CN, FR, IT, RO, AR, SE, RU, HR, SR, CZ, SK, SLO, GR, HU, JP, TH, BG, NL, PT, KA, DK, FI, SQ, TR, LV, NO, LT, MS, HY	5 l	400 cans ³
	706411 03.9901-6411.2	DE, EN, PL, ES, CN, FR, IT, RO, AR, SE, RU, HR, SR, CZ, SK, SLO, GR, HU, JP, TH, BG, NL, PT, KA, DK, FI, SQ, TR, LV	20 l	36 cans
	706420 03.9901-6420.2	DE, EN, PL, ES, CN, FR, IT, RO, AR, SE, RU, HR, SR, CZ, SK, SLO, GR, HU, JP, TH, BG, NL, PT, KA, DK, FI, SQ, TR	30 l	22 cans
	706414 03.9901-6414.2		50 l	12 cans
706405 03.9901-6405.2		200 l	1 item	
SL SAE specification, J1704-FMVSS 116/DOT 4	705801 03.9901-5801.2	DE, EN, ES, AR, TH, CN	1/2 l	1,200 cans ¹
	705831 03.9901-5831.2	PL, RO, RU, HR, SLO, KA	1/2 l	1,200 cans ¹
	705802 03.9901-5802.2	DE, EN, ES, PT, CN, FR, IT, AR, SE, NL, JP, TH, GR	1 l	600 cans ²
	705832 03.9901-5832.2	PL, RU, CZ, SK, SLO, HU, BG, KA, HR, SR, RO	1 l	600 cans ²
	705803 03.9901-5803.2	DE, EN, PL, ES, CN, FR, IT, RO, AR, SE, RU, HR, SR, CZ, SK, SLO, GR, HU, JP, TH, BG, NL, PT, KA, DK, FI, SQ, TR, LV, NO, LT, MS, HY	5 l	400 cans ³
	705811 03.9901-5811.2	DE, EN, PL, ES, CN, FR, IT, RO, AR, SE, RU, HR, SR, CZ, SK, SLO, GR, HU, JP, TH, BG, NL, PT, KA, DK, FI, SQ, TR, LV	20 l	12 cans
	705820 03.9901-5820.2	DE, EN, PL, ES, CN, FR, IT, RO, AR, SE, RU, HR, SR, CZ, SK, SLO, GR, HU, JP, TH, BG, NL, PT, KA, DK, FI, SQ, TR	30 l	22 cans
	705814 03.9901-5814.2		50 l	12 cans
705805 03.9901-5805.2		200 l	1 item	
BLAU SAE specification, J1703-FMVSS 116/DOT 3	700301 03.9901-0301.2	—	1/2 l	1,200 cans ¹
	705302 03.9901-0302.2	—	1 l	600 cans ²
	705303 03.9901-0304.2	—	12 oz	2,160 cans ⁴

Pallet unit:

¹20 cans per box.

²10 cans per box.

³4 cans per box.

⁴60 cans per box.

Item codes may be different for countries of delivery other than Germany.



DE Inhaltsverzeichnis

Herstellerverzeichnis
Produktdetails
Fahrzeugverwendungen
Technische Übersetzungen

8	Index of vehicles
15	Product details
155	Applications of vehicles
569	Technical translations

EN Table of contents

ES Índice

8	Índice de vehículos	8
15	Descripción del producto	15
155	Aplicaciones	155
569	Traducciones técnicas	569

FR Table des matières

Liste des véhicules
Présentation du produit
Applications
Traductions techniques

8	Indice autovetture
15	Panoramica prodotti
155	Applicazioni autoveicoli
569	Traduzioni tecniche

IT Sommario

8
15
155
569



DE Herstellerverzeichnis

EN Index of vehicles

ES Índice de vehículos

FR Liste des véhicules

IT Indice autovettura

2024



**ABARTH 156**

500 / 595 / 695	156
500C / 595C / 695C	156
GRANDE PUNTO	156
PUNTO	156
PUNTO EVO	156

ALFA ROMEO 156

145 (930_)	156
146 (930_)	156
159 (939_)	156
159 Sportwagon (939_)	156
166 (936_)	157
BRERA (939_)	157
GIULIETTA (940_)	157
GIULIETTA Kasten/Schrägheck (940_)	157
GTV (916_)	157
MITO (955_)	157
SPIDER (916_)	158
SPIDER (939_)	158

AUDI 158

A1 (8X1, 8XK)	158
A2 (8Z0)	158
A3 (8L1)	158
A3 (8P1)	159
A3 (8V1, 8VK)	161
A3 Cabriolet (8P7)	162
A3 Cabriolet (8V7, 8VE)	162
A3 Limousine (8VS, 8VM)	162
A3 Sportback (8PA)	163
A3 Sportback (8VA, 8VF)	165
A4 Allroad B8 (8KH)	165
A4 B5 (8D2)	165
A4 B5 Avant (8D5)	166
A4 B6 (8E2)	167
A4 B6 Avant (8E5)	167
A4 B6 Cabriolet (8H7)	168
A4 B7 (8EC)	168
A4 B7 Avant (8ED)	169
A4 B7 Cabriolet (8HE)	170
A4 B8 (8K2)	170
A4 B8 Avant (8K5)	171
A5 (8T3)	171
A5 Cabriolet (8F7)	172
A5 Sportback (8TA)	172
A6 Allroad C6 (4FH)	173
A6 Allroad C7 (4GH, 4GJ)	173
A6 C5 (4B2)	173
A6 C5 Avant (4B5)	174
A6 C6 (4F2)	176
A6 C6 Avant (4F5)	176
A6 C7 (4G2, 4GC)	176
A6 C7 Avant (4G5, 4GD)	177
A7 Sportback (4GA, 4GF)	177
A8 D2 (4D2, 4D8)	178
A8 D4 (4H2, 4H8, 4HC, 4HL)	178
ALLROAD C5 (4BH)	178
CABRIOLET B3 (8G7)	178
Q2 (GAB, GAG)	178
Q3 (8UB, 8UG)	179
Q5 (8RB)	179
Q5 Van (8RB)	180
Q7 (4LB)	180
Q7 Van (4LB)	180
TT (8J3)	181
TT (8N3)	181
TT (FV3, FVP)	181
TT Roadster (8J9)	182
TT Roadster (8N9)	182
TT Roadster (FV9, FVR)	182

BMW 182

1 (E81)	182
1 (E87)	183
1 (F20)	184
1 (F21)	185
1 (F40)	185

**BMW 182**

1 (F52)	186
1 Cabriolet (E88)	186
1 Coupe (E82)	186
1 Van (F20)	187
2 Active Tourer (F45)	187
2 Active Tourer Van (F45)	188
2 Cabriolet (F23)	188
2 Coupe (F22, F87)	188
2 Gran Coupe (F44)	188
2 Gran Tourer (F46)	189
2 Gran Tourer Van (F46)	189
3 (E46)	189
3 (E90)	190
3 (F30, F80)	191
3 Cabriolet (E36)	192
3 Cabriolet (E46)	192
3 Cabriolet (E93)	193
3 Compact (E36)	194
3 Compact (E46)	194
3 Coupe (E36)	194
3 Coupe (E46)	195
3 Coupe (E92)	195
3 Gran Turismo (F34)	197
3 Touring (E36)	197
3 Touring (E46)	198
3 Touring (E91)	198
3 Touring (F31)	200
3 Touring Van (F31)	200
4 Cabriolet (F33, F83)	201
4 Coupe (F32, F82)	201
4 Gran Coupe (F36)	201
5 (E39)	202
5 (E60)	202
5 (F10)	203
5 Gran Turismo (F07)	204
5 Touring (E39)	204
5 Touring (E61)	204
5 Touring (F11)	205
6 (E63)	205
6 Cabriolet (E64)	205
6 Cabriolet (F12)	205
6 Coupe (F13)	206
6 Gran Coupe (F06)	206
7 (E38)	206
7 (E65, E66, E67)	206
7 (F01, F02, F03, F04)	207
X1 (E84)	207
X1 (F48)	207
X1 Van (F48)	208
X2 (F39)	208
X3 (E83)	208
X3 (F25)	208
X4 (F26)	209
X5 (E53)	209
Z3 Coupe (E36)	209
Z3 Roadster (E36)	209
Z4 Coupe (E86)	209
Z4 Roadster (E85)	209
Z4 Roadster (E89)	210
Z8 Roadster (E52)	210

CHEVROLET 210

ASTRA Schrägheck	210
ASTRA Stufenheck	210
AVEO Schrägheck (T300)	210
AVEO Stufenheck (T300)	210
CORSA Kombi	210
CRUZE (J300)	210
CRUZE Schrägheck (J305)	211
CRUZE Station Wagon (J308)	211
MALIBU (V300)	212
MATIZ (M200, M250)	212
ORLANDO (J309)	212
SPARK	212
SPARK Kasten/Schrägheck (M200, M250)	213
TIGRA	213
TRAX	213
VECTRA	213

**CHRYSLER 213**

DELTA	213
VOYAGER / GRAND VOYAGER III (GS_, NS_)	213
VOYAGER / GRAND VOYAGER IV (RG)	213
VOYAGER IV (RG, RS)	213

CITROËN 214

BERLINGO / BERLINGO FIRST Großraumlimousine (MF_, GJK_, GFK_)	214
BERLINGO / BERLINGO FIRST Kasten/Großraumlimousine (M_)	214
BERLINGO Kasten/Großraumlimousine (B9)	215
BERLINGO MULTISPACE (B9)	215
BERLINGO Pritsche/Fahrgestell (B9)	215
C1 (PM_, PN_)	215
C15 Kasten/Großraumlimousine (VD_)	223
C15 Kombi	223
C15 Pritsche/Fahrgestell (VDPD)	224
C1 II (PA_, PS_)	215
C2 (JM_)	215
C2 ENTERPRISE (JG_)	216
C3 AIRCROSS II (2R_, 2C_)	218
C3 AIRCROSS II Van (2C_, 2R_)	219
C3 I (FC_, FN_)	217
C3 II (SC_)	218
C3 III (SX_)	218
C3 III Van (SX_, SY_)	218
C3 II Kasten/Schrägheck (SC_)	218
C3 PICASSO (SH_)	219
C3 Pluriel (HB_)	219
C4 CACTUS	220
C4 CACTUS Van (0B_, 0P_)	220
C4 Coupe (LA_)	220
C4 GRAND PICASSO I (UA_)	220
C4 GRAND PICASSO II (DA_, DE_)	220
C4 I (LC_)	219
C4 I Stufenheck	219
C4 PICASSO I Großraumlimousine (UD_)	221
C4 PICASSO II	221
C4 PICASSO II Van (DD_)	221
C4 SPACETOURER (3D_)	221
C4 SPACETOURER Van (3D_)	221
C5 III (RD_)	221
C5 III Break (RW_)	222
C6 (TD_)	223
C8 (EA_, EB_)	223
C8 Van (EA_, EB_)	223
C-ELYSEE (DD_)	224
DS3 (SA_)	224
DS3 Cabriolet	224
DS5	224
EVASION Großraumlimousine (22, U6)	225
GRAND C4 SPACETOURER (3A_, 3E_)	225
GRAND C4 SPACETOURER Van (3A_, 3E_)	225
JUMPER I Bus (230P)	225
JUMPER I Bus (244, Z_)	227
JUMPER II Bus	230
JUMPER II Kasten	230
JUMPER II Pritsche/Fahrgestell	230
JUMPER I Kasten (230L)	227
JUMPER I Kasten (244)	228
JUMPER I Pritsche/Fahrgestell (230)	229
JUMPER I Pritsche/Fahrgestell (244)	230
JUMPY I (U6U_)	230
JUMPY II (VF7)	231
JUMPY II Kasten	231
JUMPY II Pritsche/Fahrgestell	231
JUMPY I Kasten (BS_, BT_, BY_, BZ_)	231
JUMPY I Pritsche/Fahrgestell (BU_, BV_, BW_, BX_)	231
SAXO (S0, S1)	231
SAXO Hatchback van (S3_)	232
XSARA (N1)	232
XSARA Break (N2)	233
XSARA Coupe (N0)	234
XSARA Kasten/Kombi	234
XSARA Kasten/Schrägheck (N3_)	235
XSARA PICASSO (N68)	235

**CUPRA 235**

ATECA (KH7, KHP, KBP) 235

DACIA 235

DOKKER Express Kasten/Großraumlimousine 236
 DOKKER Großraumlimousine (KE_) 236
 DUSTER (HS_) 236
 DUSTER Kasten/SUV 236
 LODGY (JS_) 237
 LOGAN (LS_) 237
 LOGAN EXPRESS (FS_) 238
 LOGAN II 238
 LOGAN MCV (KS_) 238
 LOGAN MCV II 239
 LOGAN Pick-up (US_) 239
 SANDERO 239
 SANDERO II 240

DAEWOO 240

MATIZ (M100, M150) 240
 MATIZ (M200, M250) 240
 MATIZ (M300) 240
 MATIZ Kasten/Schrägheck (KLA4) 240

DAIHATSU 240

CHARADE VIII 240

DS 240

DS 5 (KF_) 240

FIAT 241

126 (126_) 241
 500 (312_) 241
 500 C (312_) 241
 500L (351_, 352_) 241
 BARCETTA (183_) 241
 BRAVA (182_) 241
 BRAVO I (182_) 242
 BRAVO II (198_) 242
 BRAVO Van (198_) 242
 CINQUECENTO (170_) 242
 COUPE (175_) 242
 CROMA (194_) 242
 CROMA Kasten/Kombi (194_) 243
 DOBLO Bus (263_) 243
 DOBLO Cargo (263_) 243
 DOBLO Großraumlimousine (119_, 223_) 243
 DOBLO Kasten/Großraumlimousine (223_) 243
 DOBLO Pritsche/Fahrgestell (263_) 243
 DUCATO Bus (230_) 244
 DUCATO Bus (244_) 245
 DUCATO Bus (250_) 245
 DUCATO Kasten (230_) 246
 DUCATO Kasten (244_) 247
 DUCATO Kasten (250_) 247
 DUCATO Pritsche/Fahrgestell (230_) 248
 DUCATO Pritsche/Fahrgestell (244_) 249
 DUCATO Pritsche/Fahrgestell (250_) 249
 FIORINO Kasten/Großraumlimousine (146_) 250
 FIORINO Pick up (146_) 250
 GRANDE PUNTO (199_) 250
 GRANDE PUNTO Van (199_) 251
 IDEA (350_) 251
 IDEA Van (350_) 251
 LINEA (323_, 110_) 251
 MAREA (185_) 251
 MAREA Weekend (185_) 252
 PALIO (178_, 171_) 252
 PALIO Weekend (178_, 173_, 373_, 374_, 171_) 252
 PANDA / PANDA CLASSIC (169_) 252
 PANDA (141_) 253
 PANDA (312_, 319_) 253
 PANDA Kasten/Schrägheck (141_) 253

**FIAT 241**

PANDA Kasten/Schrägheck (169_) 253
 PANDA VAN (312_, 519_) 254
 PUNTO (176_) 254
 PUNTO (188_) 254
 PUNTO (199_) 254
 PUNTO Cabriolet (176_) 255
 PUNTO EVO (199_) 255
 PUNTO EVO Kasten/Schrägheck (199_) 255
 PUNTO Kasten/Schrägheck (188_) 255
 PUNTO Kasten/Schrägheck (199_) 255
 PUNTO Van (176_) 256
 SCUDO Bus (220_) 256
 SCUDO Bus (270_, 272_) 256
 SCUDO Kasten (220_) 256
 SCUDO Kasten (270_, 272_) 256
 SCUDO Pritsche/Fahrgestell (220_) 256
 SCUDO Pritsche/Fahrgestell (270_, 272_) 256
 SEDICI (189_) 257
 SEICENTO / 600 (187_) 257
 SEICENTO / 600 Kasten/Schrägheck (287_) 257
 SIENA (178_, 172_) 257
 STRADA Pick-up (178_, 278_) 257
 TIPO Kombi (356_, 357_) 257
 TIPO Schrägheck (356_, 357_) 257
 TIPO Stufenheck (356_, 357_) 257
 ULYSSE (179_) 258
 ULYSSE (220_) 258

FORD 258

B-MAX (JK) 258
 B-MAX Van (JK) 258
 C-MAX (DM2) 258
 C-MAX II (DXA/CB7, DXA/CEU) 259
 C-MAX II Van 259
 COUGAR (EC_) 259
 ESCORT CLASSIC (AAL, ABL) 260
 ESCORT CLASSIC Turnier (ANL) 260
 ESCORT VI (GAL, AAL, ABL) 259
 ESCORT VI Cabriolet (ALL) 260
 ESCORT VI Express (AVL) 260
 ESCORT VI Stufenheck (GAL, AFL) 260
 ESCORT VI Turnier (GAL, ANL) 260
 FIESTA IV (JA_, JB_) 260
 FIESTA Kasten/Großraumlimousine (J5_, J3_) 262
 FIESTA Kasten/Schrägheck (JV_) 262
 FIESTA Stufenheck 262
 FIESTA V (JH_, JD_) 261
 FIESTA VI (CB1, CCN) 261
 FIESTA VI Van 262
 FIESTA V Van 261
 FOCUS C-MAX (DM2) 270
 FOCUS I (DAW, DBW) 263
 FOCUS II (DA_, HCP, DP) 263
 FOCUS II Cabriolet 265
 FOCUS III 269
 FOCUS III Kasten/Kombi 269
 FOCUS III Kasten/Schrägheck 269
 FOCUS III Stufenheck 269
 FOCUS III Turnier 270
 FOCUS II Kasten/Kombi 265
 FOCUS II Stufenheck (DB_, FCH, DH) 266
 FOCUS II Turnier (DA_, FFS, DS) 267
 FOCUS I Kasten/Kombi (DNW) 263
 FOCUS I Stufenheck (DFW) 263
 FOCUS I Turnier (DNW) 263
 FUSION (JU_) 271
 GALAXY I (WGR) 271
 GALAXY II (WA6) 272
 GALAXY MK II VAN (WA6) 272
 GALAXY MK I VAN (WGR) 272
 GRAND C-MAX (DXA/CB7, DXA/CEU) 272
 GRAND C-MAX Van 273
 KA 273
 KA (RU8) 273
 KUGA I 273
 KUGA II (DM2) 274
 KUGA II VAN 274
 KUGA I VAN 273

**FORD 258**

MONDEO II (BAP) 274
 MONDEO III (B5Y) 275
 MONDEO III Stufenheck (B4Y) 275
 MONDEO III Turnier (BWY) 275
 MONDEO II Stufenheck (BFP) 274
 MONDEO II Turnier (BNP) 274
 MONDEO IV (BA7) 275
 MONDEO IV Stufenheck (BA7) 276
 MONDEO IV Turnier (BA7) 276
 MONDEO IV Van 276
 PUMA (EC_) 276
 RANGER (ET) 277
 S-MAX (WA6) 277
 S-MAX VAN (WA6) 277
 TOURNEO CONNECT / GRAND 277
 TOURNEO CONNECT V408 Großraumlimousine 277
 TOURNEO COURIER B460 Großraumlimousine 277
 TRANSIT Bus (E_) 277
 TRANSIT Bus (FD_, FB_, FS_, FZ_, FC_) 278
 TRANSIT CONNECT Großraumlimousine 278
 TRANSIT CONNECT V408 Kasten/Großraumlimousine 278
 TRANSIT COURIER B460 Großraumlimousine 278
 TRANSIT COURIER B460 Kasten/Großraumlimousine 278
 TRANSIT Kasten (E_) 278
 TRANSIT Kasten (FA_) 278
 TRANSIT Pritsche/Fahrgestell (E_) 279
 TRANSIT Pritsche/Fahrgestell (FM_, FN_, FF_) 279
 TRANSIT Pritsche/Fahrgestell (FM_, FN_) 279
 TRANSIT TOURNEO Bus 279
 TRANSIT TOURNEO Bus (FC_) 280

FSO 280

126P 280

HONDA 280

ACCORD VII (CL, CN) 280
 ACCORD VII Tourer (CM, CN) 280
 CIVIC VI Coupe (EJ, EM1) 280
 CIVIC VI Hatchback (EJ, EK) 280
 CIVIC VIII Hatchback (FN, FK) 280
 CIVIC VI Stufenheck (EJ, EK, SO) 280

HYUNDAI 280

ATOS (MX) 280
 GETZ (TB) 280
 i10 I (PA) 281
 i10 II (BA, IA) 281
 i10 II Stufenheck 281
 i30 (GD) 281
 i30 Coupe 281
 i30 Hatchback Van (GDE) 281
 i30 Kombi (GD) 282
 i30 Kombi Van (GDE, GD) 282
 i40 I (VF) 282
 i40 I CW (VF) 282
 i40 I Kombi Van (VF) 282
 ix20 (JC) 282
 ix35 (LM, EL, ELH) 283
 ix35 Van 283
 MATRIX (FC) 283
 TUCSON (TL, TLE) 283
 VELOSTER (FS) 283

JAGUAR 283

S-TYPE II (X200) 283
 XF I (X250) 284
 XF SPORTBRAKE (X250) 284
 XJ (X350, X358) 284



**JAGUAR 283**

XJ (X351)	285
XK 8 Convertible (X100)	285
XK 8 Coupe (X100)	285
XK II Cabriolet (X150)	285
XK II Coupe (X150)	285

JEEP 285

COMPASS (MP, M6, MV, M7)	285
RENEGADE SUV (BU, B1, BV)	285
RENEGADE VAN (BU, B1)	286

KIA 286

CEE'D (JD)	286
CEE'D Combi Van (JD)	286
CEE'D Sportswagon (JD)	286
PRO CEE'D (JD)	286
PRO CEE'D Hatchback Van (JD)	287
SORENTO I (JC)	287
SPORTAGE III (SL)	287
SPORTAGE IV (QL, QLE)	287
SPORTAGE IV VAN (QL, QLE)	288

LADA 288

110 (2110)	288
111 (2111)	288
112 (2112)	288
1200-1600	288
NOVA (2105)	288
NOVA Kombi (2104)	288
SAMARA (2108, 2109, 2113, 2114)	288
SAMARA Schrägheck (2113, 2114)	289
SAMARA Stufenheck (21099, 2115)	289
TAIGA Geländewagen geschlossen (2121, 2131)	289

LANCIA 289

DEDRA (835_)	289
DELTA II (836_)	289
DELTA III (844_)	289
MUSA (350_)	289
PHEDRA (179_)	289
Y (840_)	290
YPSILON (843_)	290
ZETA (22_)	290

LAND ROVER 290

DISCOVERY IV (L319)	290
DISCOVERY IV VAN (L319)	290
FREELANDER 2 (L359)	290
FREELANDER 2 VAN (L359)	291
RANGE ROVER EVOQUE (L538)	291
RANGE ROVER EVOQUE Cabriolet (L538)	291
RANGE ROVER EVOQUE VAN (L538)	291
RANGE ROVER III (L322)	291
RANGE ROVER SPORT I (L320)	291

MAZDA 291

2 (DY)	291
3 (BK)	291
3 (BL)	292
3 Stufenheck (BK)	292
3 Stufenheck (BL)	292
6 Hatchback (GG)	292
6 Station Wagon (GY)	292
6 Stufenheck (GG)	292
BT-50 Pick-up (CD, UN)	293
BT-50 Pritsche/Fahrgestell (CD, UN)	293
CX-5 (KE, GH)	293
CX-5 (KF)	293
CX-5 Van (KE_)	293

**MERCEDES-BENZ 293**

A-KLASSE (W168)	294
A-KLASSE (W169)	294
A-KLASSE (W176)	294
B-KLASSE Sports Tourer (W245)	294
B-KLASSE Sports Tourer (W246, W242)	294
C-KLASSE (W202)	295
C-KLASSE (W203)	296
C-KLASSE (W204)	297
C-KLASSE (W205)	298
C-KLASSE Cabriolet (A205)	299
C-KLASSE Coupe (C204)	299
C-KLASSE Coupe (C205)	299
C-KLASSE Sportcoupe (CL203)	300
C-KLASSE T-Model (S202)	300
C-KLASSE T-Model (S203)	301
C-KLASSE T-Model (S204)	302
C-KLASSE T-Model (S205)	303
CLA Coupe (C117)	303
CLA Shooting Brake (X117)	304
CLC-KLASSE (CL203)	304
CLK (C208)	304
CLK (C209)	305
CLK Cabriolet (A208)	306
CLK Cabriolet (A209)	306
CLS (C218)	307
CLS (C219)	307
CLS (C257)	307
CLS Shooting Brake (X218)	307
E-KLASSE (W210)	308
E-KLASSE (W211)	308
E-KLASSE (W212)	309
E-KLASSE (W213)	310
E-KLASSE All-Terrain (S213)	311
E-KLASSE Cabriolet (A207)	311
E-KLASSE Cabriolet (A238)	311
E-KLASSE Coupe (C207)	312
E-KLASSE Coupe (C238)	312
E-KLASSE Pritsche/Fahrgestell (VF211)	313
E-KLASSE T-Model (S210)	313
E-KLASSE T-Model (S211)	313
E-KLASSE T-Model (S212)	314
E-KLASSE T-Model (S213)	315
EQC (N293)	315
eSPRINTER Kasten (B910)	315
G-KLASSE (W461)	315
G-KLASSE (W463)	316
G-KLASSE Cabrio (W463)	316
GLA-KLASSE (X156)	316
GLC (X253)	316
GLC Coupe (C253)	317
GLK-KLASSE (X204)	317
GL-KLASSE (X164)	318
M-KLASSE (W163)	318
M-KLASSE (W164)	318
R-KLASSE (W251, V251)	319
S-KLASSE (W220)	319
S-KLASSE (W221)	320
S-KLASSE Coupe (C215)	321
S-KLASSE Coupe (C216)	321
SL (R129)	322
SL (R230)	322
SL (R231)	322
SLC (R172)	322
SLK (R170)	322
SLK (R171)	323
SLK (R172)	323
SPRINTER 2-t Bus (B901, B902)	323
SPRINTER 2-t Kasten (B901, B902)	323
SPRINTER 2-t Pritsche/Fahrgestell (B901, B902)	323
SPRINTER 3,5-t Bus (B906)	324
SPRINTER 3,5-t Kasten (B906)	324
SPRINTER 3,5-t Kasten (B907, B910)	324
SPRINTER 3,5-t Pritsche/Fahrgestell (B906)	325
SPRINTER 3,5-t Pritsche/Fahrgestell (B907, B910)	325
SPRINTER 3,5-t Tourer Bus (B907)	325
SPRINTER 3-t Bus (B903)	325
SPRINTER 3-t Bus (B906)	325
SPRINTER 3-t Kasten (B903)	326
SPRINTER 3-t Kasten (B906)	326

**MERCEDES-BENZ 293**

SPRINTER 3-t Kasten (B910)	326
SPRINTER 3-t Pritsche/Fahrgestell (B903)	326
SPRINTER 3-t Pritsche/Fahrgestell (B906)	326
SPRINTER 3-t Pritsche/Fahrgestell (B910, B907)	327
SPRINTER 3-t Tourer Bus (B907)	327
SPRINTER 4,6-t Kasten (B906)	327
SPRINTER 4,6-t Pritsche/Fahrgestell (B906)	327
SPRINTER 4-t Bus (B904)	327
SPRINTER 4-t Kasten (B904)	327
SPRINTER 4-t Kasten (B907, B910)	328
SPRINTER 4-t Pritsche/Fahrgestell (B904)	328
SPRINTER 4-t Pritsche/Fahrgestell (B907, B910)	328
SPRINTER 4-t Tourer Bus (B907)	328
SPRINTER 5-t Bus (B906)	328
SPRINTER 5-t Kasten (B906)	329
SPRINTER 5-t Kasten (B907)	329
SPRINTER 5-t Pritsche/Fahrgestell (B906)	329
SPRINTER 5-t Pritsche/Fahrgestell (B907)	329
VANEO (414)	330
VARIO Bus (B670)	330
VARIO Kasten (B667, B670, B668)	330
VARIO Kipper	330
VARIO Pritsche/Fahrgestell (B670, B668, B667)	330
VARIO Triebkopf	331
VIANO (W639)	331
VITO / MIXTO Kasten (W639)	331
VITO Bus (W638)	332
VITO Bus (W639)	332
VITO Kasten (W638)	332
V-KLASSE (638/2)	332

MINI 332

MINI (F55)	332
MINI (F56)	332
MINI (R50, R53)	333
MINI (R56)	333
MINI Cabriolet (F57)	333
MINI Cabriolet (R52)	334
MINI Cabriolet (R57)	334
MINI CLUBMAN (F54)	334
MINI CLUBMAN (R55)	334
MINI CLUBVAN (R55)	334
MINI COUNTRYMAN (F60)	335
MINI COUNTRYMAN (R60)	335
MINI Coupe (R58)	335
MINI PACEMAN (R61)	335
MINI Roadster (R59)	336

MITSUBISHI 336

CARISMA (DA_)	336
CARISMA Stufenheck (DA_)	336
COLT CZC VI Cabriolet (RG)	336
COLT Kasten/Schrägheck (Z3_V)	336
COLT VI (Z3_A, Z2_A)	336

NISSAN 336

BLUEBIRD SYLPHY / SYLPHY III (B17)	336
INTERSTAR Bus (X70)	336
INTERSTAR Kasten (X70)	336
INTERSTAR Pritsche/Fahrgestell (X70)	337
KUBISTAR Kasten (X76)	337
MICRA C+C III (K12)	337
MICRA III (K12)	337
NAVARA NP300 (D40)	338
NAVARA NP300 Pritsche/Fahrgestell (D40)	338
NOTE (E11, NE11)	338
NOTE VAN (E11)	338
NP300 PICKUP (D22)	338
PATHFINDER III (R51)	338
PATHFINDER III VAN (R51_)	338
PRIMASTAR Bus (X83)	338
PRIMASTAR Kasten (X83)	339
PRIMASTAR Pritsche/Fahrgestell (X83)	339
PRIMERA (P12)	339

**NISSAN****336**

PRIMERA Hatchback (P12)	339
PRIMERA Kombi (WP12)	339
PULSAR Schrägheck (C13)	339
QASHQAI / QASHQAI +2 I (J10, NJ10, JJ10E)	340
QASHQAI / QASHQAI +2 I VAN (J10, JJ10E)	340
QASHQAI II SUV (J11, J11_)	340
QASHQAI II VAN (J11_)	340
SENTRA VII (B17)	340
TIIDA Schrägheck (C12)	340
X-TRAIL I (T30)	341
X-TRAIL III (T32_, T32R, T32RR)	341
X-TRAIL VAN (T32)	341

OPEL**341**

ADAM (M13)	341
AGILA (A) (H00)	341
AGILA (B) (H08)	341
ASTRA F Cabriolet (T92)	342
ASTRA F CLASSIC Caravan (T92)	342
ASTRA F CLASSIC CC (T92)	342
ASTRA F CLASSIC Stufenheck (T92)	342
ASTRA F Kasten/Kombi (T92)	342
ASTRA G Cabriolet (T98)	342
ASTRA G Caravan (T98)	342
ASTRA G CC (T98)	343
ASTRA G CLASSIC (T98)	343
ASTRA G CLASSIC Caravan (F35)	344
ASTRA G CLASSIC Stufenheck (T98)	344
ASTRA G Coupe (T98)	344
ASTRA G Kasten/Kombi (F70)	344
ASTRA G Stufenheck (T98)	344
ASTRA H (A04)	345
ASTRA H Caravan (A04)	345
ASTRA H CLASSIC Kombi (A04)	346
ASTRA H CLASSIC Schrägheck (A04)	346
ASTRA H CLASSIC Stufenheck (A04)	347
ASTRA H GTC (A04)	347
ASTRA H Kasten/Kombi (L70)	348
ASTRA H Stufenheck (A04)	348
ASTRA H TwinTop (A04)	349
ASTRA J (P10)	349
ASTRA J Caravan (P10)	349
ASTRA J GTC	350
ASTRA J Kasten/Kombi (P10)	351
ASTRA J Kasten/Schrägheck (P10)	351
ASTRA J Stufenheck	351
CASCADA (W13)	351
COMBO Kasten/Großraumlimousine	352
COMBO Kasten/Großraumlimousine (71_)	352
COMBO Tour	352
CORSA B (S93)	352
CORSA B Kasten/Schrägheck (S93)	352
CORSA B Kombi (S93)	352
CORSA C (X01)	352
CORSA C Kasten/Schrägheck (X01)	353
CORSA D (S07)	353
CORSA D Kasten/Schrägheck (S07)	353
CORSA E (X15)	353
CORSA E Kasten/Schrägheck (X15)	354
CROSSLAND X / CROSSLAND (P17, P2QO)	354
CROSSLAND X Van	354
INSIGNIA A (G09)	354
INSIGNIA A Country Tourer (G09)	355
INSIGNIA A Sports Tourer (G09)	355
INSIGNIA A Stufenheck (G09)	356
MERIVA A Großraumlimousine (X03)	356
MOKKA / MOKKA X (J13)	357
MOKKA X VAN (J13)	357
MOVANO A Bus (X70)	357
MOVANO A Kasten (X70)	357
MOVANO A Pritsche/Fahrgestell (X70)	357
OMEGA B (V94)	357
OMEGA B Caravan (V94)	358
SIGNUM CC (Z03)	358
TIGRA (S93)	358
TIGRA TwinTop (X04)	358
VECTRA B (J96)	358

**OPEL****341**

VECTRA B Caravan (J96)	359
VECTRA B CC (J96)	359
VECTRA C (Z02)	359
VECTRA C Caravan (Z02)	360
VECTRA C CC (Z02)	360
VIVARO A Bus (X83)	360
VIVARO A Kasten (X83)	360
VIVARO A Pritsche/Fahrgestell (X83)	361
ZAFIRA / ZAFIRA FAMILY B (A05)	361
ZAFIRA A Großraumlimousine (T98)	362
ZAFIRA B Kasten/Großraumlimousine (A05)	362
ZAFIRA TOURER C (P12)	362
ZAFIRA TOURER C VAN (P12)	363

PEUGEOT**363**

1007 (KM_)	386
106 II (1A_, 1C_)	363
106 Van II Kasten/Schrägheck (1S_)	363
107 (PM_, PN_)	363
108	364
2008 I (CU_)	386
2008 I Van (CU_)	387
206+ (2L_, 2M_)	369
206 CC (2D)	364
206 Schrägheck (2A/C)	364
206 Stufenheck	366
206 SW (2E/K)	367
206 Van	368
207 (WA_, WC_)	369
207 CC (WD_)	370
207 Kasten/Schrägheck (WA_, WC_)	370
207 Stufenheck	370
207 SW (WK_)	370
207 SW Kasten/Kombi (WK_)	370
208 I (CA_, CC_)	370
208 Kasten/Schrägheck (CR_)	371
3008 Großraumlimousine (0U_)	387
3008 Van (0U_)	387
301	371
306 (7B, N3, N5)	371
306 Break (7E, N3, N5)	374
306 Cabriolet (7D, N3, N5)	374
306 Kasten/Kombi (N_, 7_)	375
306 Kasten/Schrägheck	375
306 Schrägheck (7A, 7C, N3, N5)	376
307 (3A/C)	378
307 Break (3E)	378
307 CC (3B)	378
307 Stufenheck	379
307 SW (3H)	379
307 SW Kasten/Kombi (3E_, 3H_)	379
308 CC (4B_)	379
308 I (4A_, 4C_)	379
308 II (LB_, LP_, LW_, LH_, L3_)	379
308 Kasten/Schrägheck (LB_)	379
308 SW I (4E_, 4H_)	380
308 SW II (LC_, Lj_, LR_, LX_, L4_)	380
308 SW II Kasten/Kombi (LC_)	380
308 SW I Kasten/Kombi (4E_)	380
406 (8B)	380
406 Break (8E/F)	381
406 Coupe (8C)	382
407 (6D_)	383
407 Coupe (6C_)	383
407 SW (6E_, 6D_)	383
407 SW Kasten/Kombi (6E_)	384
5008 (0U_, 0E_)	387
5008 I Van (0U_)	387
508 I (8D_)	384
508 SW I (8E_)	384
508 SW Kasten/Kombi (8E_)	385
605 (6B)	385
806 (221)	385
807 (EB_)	386
807 Van (EB_)	386
BOXER Bus	387
BOXER Bus (230P)	388
BOXER Bus (244, Z_)	390
BOXER Kasten	390

**PEUGEOT****363**

BOXER Kasten (230L)	390
BOXER Kasten (244)	392
BOXER Pritsche/Fahrgestell	392
BOXER Pritsche/Fahrgestell (244)	392
BOXER Pritsche/Fahrgestell (ZCT_)	392
EXPERT (224_)	394
EXPERT Kasten (222)	394
EXPERT Kasten (VF3A_, VF3U_, VF3X_)	394
EXPERT Pritsche/Fahrgestell	394
EXPERT Pritsche/Fahrgestell (223)	394
EXPERT TEPEE (VF3X_)	395
PARTNER Großraumlimousine (5_, G_)	395
PARTNER Kasten/Großraumlimousine	396
PARTNER Kasten/Großraumlimousine (5_, G_)	396
PARTNER ORIGIN Großraumlimousine (G_)	396
PARTNER ORIGIN Kasten/Großraumlimousine (G_)	396
PARTNER Pritsche/Fahrgestell	396
PARTNER Pritsche/Fahrgestell (5_, G_)	397
PARTNER TEPEE	397

PORSCHE**397**

911 (996)	397
911 (997)	397
911 Cabriolet (996)	397
911 Cabriolet (997)	397
911 Targa (996)	398
BOXSTER (986)	398
BOXSTER (987)	398
BOXSTER Spyder (987)	398
CAYENNE (9PA)	398
CAYMAN (987)	398

RENAULT**398**

19 II Cabriolet (D53_, 853_)	399
AVANTIME (DE0_)	399
CAPTUR I (J5_, H5_)	399
CLIO II (BB_, CB_)	399
CLIO III (BR0/1, CR0/1)	400
CLIO III Grandtour (KR0/1_)	401
CLIO III Kasten/Schrägheck (SB_, SR_)	401
CLIO II Kasten/Schrägheck (SB0/1/2_)	400
CLIO IV (BH_)	402
CLIO IV Grandtour (KH_)	402
CLIO IV Kasten/Kombi (KH_)	402
CLIO IV Kasten/Schrägheck (BH_)	402
DOKKER	403
DUSTER (HS_)	403
ESPACE III (JE0_)	403
ESPACE IV (JK0/1_)	403
EXPRESS Pick-up	404
GRAND SCÉNIC II (JM0/1_)	404
GRAND SCÉNIC III (JZ0/1_)	404
KADJAR (HA_, HL_)	404
KANGOO / GRAND KANGOO II (KW0/1_)	404
KANGOO (KC0/1_)	405
KANGOO BE BOP (KW0/1_)	405
KANGOO Express (FC0/1_)	405
KANGOO Express (FW0/1_)	405
KAPTUR (H5_)	405
KOLEOS II (HC_)	406
LAGUNA I (B56_, 556_)	406
LAGUNA I Grandtour (K56_)	406
LAGUNA II (BG0/1_)	407
LAGUNA II Grandtour (KG0/1_)	408
LODGY (JS_)	409
LOGAN/STEPWAY II (L8_)	410
LOGAN EXPRESS (US_)	410
LOGAN I (LS_)	410
LOGAN II Kombi (K8_)	410
LOGAN I Kombi (KS_)	410
MASTER II Bus (JD)	410
MASTER III Bus (JV)	411
MASTER III Kasten (FV)	411
MASTER III Pritsche/Fahrgestell (EV, HV, UV)	412
MASTER II Kasten (FD)	411



**RENAULT****398**

MASTER II Pritsche/Fahrgestell (ED/HD/UD)	411
MEGANE CC (EZ0/1_)	422
MEGANE I (BA0/1_)	412
MEGANE I Cabriolet (EA0/1_)	414
MEGANE I Classic (LA0/1_)	415
MEGANE I Coach (DA0/1_)	417
MEGANE I Grandtour (KA0/1_)	417
MEGANE I Hatchback Van (SA0/1_)	418
MEGANE II (BM0/1_, CM0/1_)	419
MEGANE II Coupé-Cabriolet (EM0/1_)	419
MEGANE II Hatchback Van (KM0/2_)	419
MEGANE III Combi Van (KZ0/1)	421
MEGANE III Coupe (DZ0/1_)	421
MEGANE III Grandtour (KZ0/1)	421
MEGANE III Hatchback Van (BZ_)	421
MEGANE III Schrägheck (BZ0/1_, B3_)	421
MEGANE II Kasten/Kombi (KM_)	420
MEGANE II Kombi (KM0/1_)	420
MEGANE II Stufenheck (LM0/1_)	420
Megane I Kombi van (KA_)	418
MEGANE Scenic (JA0/1_)	422
MODUS / GRAND MODUS (F/JPO_)	422
SAFRANE II (B54_)	423
SANDERO/STEPWAY I (BS_)	423
SANDERO/STEPWAY II (B8_)	423
SCÉNIC I Großraumlimousine (JA0/1_, FA0_)	424
SCÉNIC II (JM0/1_)	424
SCÉNIC III (JZ0/1_)	424
SCÉNIC III VAN (JZ0/1_)	425
THALIA I (LB_)	425
THALIA II (LU_)	425
THALIA III (L8_)	425
TRAFIC Bus (T_, P_, V_)	426
TRAFIC II Bus (JL)	425
TRAFIC II Kasten (FL)	426
TRAFIC II Pritsche/Fahrgestell (EL)	426
TRAFIC Kasten (T_, P_, V_)	426
TWINGO I (C06_)	427
TWINGO II (CN0_)	427
TWINGO III (BCM_, BCA_)	427
TWINGO II Kasten/Schrägheck (CNO_)	427
TWINGO I Kasten/Schrägheck (S06_)	427
VEL SATIS (BJ0_)	427
WIND (E4M_)	428

SAAB**428**

9-3 (YS3D)	428
9-3 (YS3F, E79, D79, D75)	428
9-3 Cabriolet (YS3D)	429
9-3 Cabriolet (YS3F)	429
9-3 Kombi (E50)	429
9-3X (YS3)	429
9-5 (YS3E)	430
9-5 (YS3G)	430
9-5 Kombi (YS3E)	430

SEAT**430**

ALHAMBRA (710, 711)	432
ALHAMBRA (7V8, 7V9)	430
ALHAMBRA VAN (711)	432
ALHAMBRA VAN (7V8, 7V9)	432
ALTEA (5P1)	432
ALTEA XL (5P5, 5P8)	434
AROSA (6H1)	435
ATECA (KH7, KHP)	435
CORDOBA (6K1, 6K2)	436
CORDOBA (6L2)	436
CORDOBA Varío (6K5)	437
CORDOBA VARIO Kasten/Kombi (6K5)	438
EXEO (3R2)	438
EXEO ST (3R5)	438
IBIZA II (6K1)	438
IBIZA III (6L1)	440
IBIZA IV (6J5, 6P1)	440
IBIZA IV Kasten/Schrägheck (6J1)	440
IBIZA IV SC (6J1, 6P5)	441

**SEAT****430**

IBIZA IV ST (6J8, 6P8)	441
IBIZA V (KJ1, KJG)	441
INCA (6K9)	441
LEON (1M1)	442
LEON (1P1)	442
LEON (5F1)	445
LEON Kasten/Schrägheck (5F1)	446
LEON SC (5F5)	447
LEON ST (5F8)	448
LEON ST Kasten/Kombi (5F8)	448
MARBELLA Kasten/Schrägheck (028A)	449
Mii (KF1, KE1)	449
TOLEDO I (1L2)	449
TOLEDO II (1M2)	450
TOLEDO III (5P2)	450

SKODA**451**

CITIGO (NF1)	451
FABIA I (6Y2)	451
FABIA I Combi (6Y5)	451
FABIA II (542)	453
FABIA II Combi (545)	454
FABIA I Praktik (6Y5)	452
FABIA I Stufenheck (6Y3)	452
FELICIA I Pick-up (6UF, 6U7)	454
KAROQ (NU7, ND7)	455
KODIAQ (NS6, NS7, NV7)	455
OCTAVIA I (1U2)	455
OCTAVIA I Combi (1U5)	456
OCTAVIA II (1Z3)	457
OCTAVIA II Combi (1Z5)	458
OCTAVIA III (5E3, NL3, NR3)	460
OCTAVIA III Combi (5E5, 5E6)	460
OCTAVIA I Kasten/Kombi (1U5)	457
ROOMSTER (5J7)	461
ROOMSTER Praktik (5J)	461
SUPERB I (3U4)	461
SUPERB II (3T4)	462
SUPERB III (3V3)	463
SUPERB III Kombi (3V5)	463
SUPERB II Kombi (3T5)	462
YETI (5L)	463

SMART**463**

CITY-COUPÉ (450)	463
CROSSBLADE (450)	464
FORFOUR (454)	464
FORFOUR Schrägheck (453)	464
FORTWO Cabrio (450)	464
FORTWO Cabrio (451)	464
FORTWO Cabriolet (453)	464
FORTWO Coupe (450)	464
FORTWO Coupe (451)	464
FORTWO Coupe (453)	464

SUBARU**465**

JUSTY III (G3X)	465
-----------------	-----

SUZUKI**465**

IGNIS II (MH)	465
JIMNY Geländewagen geschlossen (SN)	465
JIMNY Geländewagen offen (SN)	465
SPLASH (EX)	465
SWIFT III (MZ, EZ)	465
SX4 (EY, GY)	465
SX4 Stufenheck (GY, RW)	466
WAGON R+ Schrägheck (MM)	466
WAGON R Schrägheck	466

TOYOTA**466**

AVENSIS (_T25_)	466
AVENSIS Kombi (_T25_)	466
AVENSIS Stufenheck (_T25_)	466
AYGO (_B1_)	467

**TOYOTA****466**

AYGO (_B4_)	467
AYGO Kasten/Schrägheck (_B1_)	467
COROLLA (_E11_)	467
COROLLA (_E12_)	467
COROLLA Compact (_E10_)	468
COROLLA Compact (_E11_)	468
COROLLA Kasten/Kombi (_E11_)	468
COROLLA Kombi (_E11_)	468
COROLLA Kombi (_E12_)	468
COROLLA Liftback (_E11_)	468
COROLLA Stufenheck (_E12_)	468
COROLLA Verso (_E12_)	469
COROLLA Verso (ZER_, ZZE12_, R1_)	469
RAV 4 II (_A2_)	469
YARIS / VIOS Stufenheck (_P9_)	469
YARIS (_P1_)	469
YARIS (_P13_)	470
YARIS (_P9_)	470
YARIS Kasten/Schrägheck (_P13_)	470

VAUXHALL**470**

ADAM (M13)	470
AGILA Mk I (A) (H00)	471
AGILA Mk II (B) (H08)	471
ASTRA Mk III (F) Cabriolet (T92)	471
ASTRA Mk IV (G) Cabriolet (T98)	471
ASTRA Mk IV (G) CC (T98)	471
ASTRA Mk IV (G) Coupe (T98)	471
ASTRA Mk IV (G) Kombi (T98)	472
ASTRA Mk IV (G) Stufenheck (T98)	472
ASTRA Mk V (H) (A04)	472
ASTRA Mk V (H) Kombi (A04)	473
ASTRA Mk V (H) Sport Hatch (A04)	474
ASTRA Mk V (H) TwinTop (A04)	475
ASTRA Mk VI (J) (P10)	475
ASTRA Mk VI (J) GTC (P10)	476
ASTRA Mk VI (J) Kombi (P10)	476
ASTRAVAN Mk IV (G) Kasten/Kombi (T98)	477
ASTRAVAN Mk V (H) Kasten/Kombi (A04)	477
CASCADA Cabriolet (W13)	477
COMBO Mk I (B) (S93)	478
COMBO Mk II (C) Kasten/Großraumlimousine (F25)	478
COMBO TOUR Mk II (C) (F25)	478
CORSA Mk I (B) (S93)	478
CORSA Mk II (C) (X01)	478
CORSA Mk III (D) (S07)	479
CORSA Mk IV (E) (X15)	479
CORSAVAN Mk I (B) Kasten/Schrägheck (S93)	479
CORSAVAN Mk II (C) Kasten/Schrägheck (X01)	479
CORSAVAN Mk III (D) Kasten/Schrägheck (S07)	479
CORSAVAN Mk IV (E) Kasten/Schrägheck (X15)	480
CROSSLAND X / CROSSLAND (P17)	480
INSIGNIA Mk I (A) Country Tourer (G09)	480
INSIGNIA Mk I (A) Schrägheck (G09)	480
INSIGNIA Mk I (A) Sports Tourer (G09)	481
INSIGNIA Mk I (A) Stufenheck (G09)	481
MERIVA A (X03)	482
MOKKA / MOKKA X (J13)	482
MOVANO Mk I (A) Chassis/Cab (X70)	483
MOVANO Mk I (A) Combi (X70)	483
MOVANO Mk I (A) Van (X70)	483
OMEGA (B) Kombi (V94)	483
OMEGA (B) Stufenheck (V94)	484
SIGNUM (Z03)	484
TIGRA Mk I (S93)	484
TIGRA TwinTop (X04)	484
VECTRA (B) CC (J96)	484
VECTRA (B) Kombi (J96)	485
VECTRA (B) Stufenheck (J96)	485
VECTRA Mk II (C) (Z02)	486
VECTRA Mk II (C) CC (Z02)	486
VECTRA Mk II (C) Kombi (Z02)	487
VIVARO A Bus (X83)	487
VIVARO A Kasten (X83)	487
VIVARO A Pritsche/Fahrgestell (X83)	487

**VAUXHALL****470**

ZAFIRA A (T98)	487
ZAFIRA Mk II (B) (A05)	488
ZAFIRA Mk III (P12)	488

VOLVO**489**

C30 (533)	489
C70 I Cabriolet (873)	489
C70 I Coupe (872)	490
C70 II Cabriolet (542)	490
S40 I (644)	490
S40 II (544)	491
S60 I (384)	491
S60 II (134)	495
S60 II Cross Country (134)	496
S70 (874)	496
S80 I (184)	496
S80 II (124)	497
V40 Cross Country (526)	498
V40 Kasten/Schrägheck (525)	499
V40 Kombi (645)	499
V40 Schrägheck (525)	499
V50 (545)	499
V60 I (155)	500
V60 I Cross Country (157)	501
V60 I Kasten/Kombi (155)	501
V70 I (875, 876)	502
V70 II (285)	502
V70 III (135)	505
V70 III Kasten/Kombi (135)	506
XC60 I SUV (156)	506
XC60 I VAN (156)	507
XC70 I Cross Country (295)	508
XC70 II (136)	508
XC70 II VAN (136)	509
XC90 I (275)	509
XC90 I VAN (275)	510

VW**510**

AMAROK (2HA, 2HB, S1B, S6B, S7A, S7B)	510
AMAROK Pritsche/Fahrgestell (S1B, S6B, S7B)	510
ARTEON (3H7, 3H8)	510
ARTEON SHOOTING BRAKE (3H9)	510
BEETLE (5C1, 5C2)	511
BEETLE Cabriolet (5C7, 5C8)	511
BORA (9M2)	511
BORA I (1J2)	512
BORA Variant (1J6)	513
CADDY ALLTRACK Großraumlimousine (SAB)	517
CADDY ALLTRACK Kasten/Großraumlimousine (SAA)	517
CADDY II Großraumlimousine (9K9B)	514
CADDY III Großraumlimousine (2KB, 2KJ, 2CB, 2CJ)	515
CADDY III Kasten/Großraumlimousine (2KA, 2KH, 2CA, 2CH)	516
CADDY II Kasten/Großraumlimousine (9K9A)	515
CADDY II Pick-up (9U7)	515
CADDY IV Großraumlimousine (SAB, SAJ)	516
CADDY IV Kasten/Großraumlimousine (SAA, SAH)	516
CADDY Kasten/Großraumlimousine (6K9, 9E7, 9E9)	517
CALIFORNIA T5 Camper (7EC, 7EF, 7EG, 7HF)	517
CC B7 (358)	518
CRAFTER 30-35 Bus (2E_)	518
CRAFTER 30-50 Kasten (2E_)	518
CRAFTER 30-50 Pritsche/Fahrgestell (2F_)	519
EOS (1F7, 1F8)	519
FOX Schrägheck (5Z1, 5Z3, 5Z4)	519
FOX Van (5Z1)	520
GOLF ALLTRACK VII Variant (BA5, BV5)	530
GOLF III Variant (1H5)	520
GOLF IV (1J1)	521
GOLF IV (9B3)	522
GOLF IV Cabriolet (1E7)	523

**VW****510**

GOLF IV Van (1J1)	523
GOLF IV Variant (1J5)	524
GOLF Kasten/Schrägheck (1K1)	530
GOLF PLUS V (5M1, 521)	531
GOLF PLUS Van (521)	534
GOLF SPORTSVAN VII (AM1, AN1)	536
GOLF V (1K1)	525
GOLF VAN IV Variant (1J5)	536
GOLF VAN VII Variant (BA5)	537
GOLF VAN VI Variant (AJ5)	537
GOLF VI (5K1)	527
GOLF VI Cabriolet (517)	528
GOLF VII (5G1, BQ1, BE1, BE2)	529
GOLF VII Van (5G1)	529
GOLF VII Variant (BA5, BV5)	530
GOLF VI Van (5K1_)	528
GOLF VI Variant (AJ5)	528
GOLF V Variant (1K5)	526
JETTA III (1K2)	537
JETTA IV (162, 163, AV3, AV2)	538
JETTA VII Stufenheck (BU3, BU4)	538
LOAD UP (121, 122, BL1, BL2)	538
LT 28-35 II Bus (2DB, 2DE, 2DK)	538
LT 28-46 II Kasten (2DA, 2DD, 2DH)	539
LT 28-46 II Pritsche/Fahrgestell (2DC, 2DF, 2DG, 2DL, 2DM)	539
LUPO I (6X1, 6E1)	539
MULTIVAN T5 (7HM, 7HN, 7HF, 7EF, 7EM, 7EN)	539
NEW BEETLE (9C1, 1C1)	540
NEW BEETLE Cabriolet (1Y7)	541
PASSAT ALLTRACK B7 (365)	542
PASSAT ALLTRACK B8 Variant (3G5, CB5)	542
PASSAT B5.5 (3B3)	542
PASSAT B5.5 Variant (3B6)	542
PASSAT B5 (3B2)	543
PASSAT B5 Variant (3B5)	544
PASSAT B6 (3C2)	544
PASSAT B6 Variant (3C5)	545
PASSAT B7 (362)	545
PASSAT B7 (A32, A33)	546
PASSAT B7 Kasten/Kombi (365)	546
PASSAT B7 Variant (365)	547
PASSAT B8 (3G2, CB2)	547
PASSAT B8 Variant (3G5, CB5)	547
PASSAT CC B6 (357)	548
POLO (6N2)	548
POLO (9N_, 9A_)	549
POLO III (6N1)	550
POLO III CLASSIC (6V2)	550
POLO IV Stufenheck (9A4, 9A2, 9N2, 9A6)	551
POLO IV Stufenheck (9N2)	552
POLO Van Kasten/Kombi (6V5)	552
POLO Van Kasten/Schrägheck (6N1)	552
POLO Variant (6V5)	552
SCIROCCO III (137, 138)	552
SCIROCCO Van (137)	554
SHARAN (7M8, 7M9, 7M6)	555
SHARAN (7N1, 7N2)	556
SHARAN VAN (7M_)	557
SHARAN VAN (7N1, 7N2)	557
TIGUAN (5N_)	557
TIGUAN (AD1, AX1)	558
TIGUAN Kasten/SUV (AD1)	558
TIGUAN VAN (5N_)	558
TOUAREG (7LA, 7L6, 7L7)	558
TOURAN (1T1, 1T2)	559
TOURAN (1T3)	560
TOURAN (5T1)	561
TOURAN VAN (1T1, 1T2)	561
TOURAN VAN (1T3)	561
TOURAN VAN (5T1)	562
TRANSPORTER T4 Bus (70B, 70C, 7DB, 7DK, 70J, 70K, 7DC, 7DJ)	562
TRANSPORTER T4 Kasten (70A, 70H, 7DA, 7DH)	563
TRANSPORTER T4 Pritsche/Fahrgestell (70E, 70L, 70M, 7DE, 7DL)	564
TRANSPORTER T5 Bus (7HB, 7HJ, 7EB, 7EJ)	565

**VW****510**

TRANSPORTER T5 Kasten (7HA, 7HH, 7EA, 7EH)	566
TRANSPORTER T5 Pritsche/Fahrgestell (7JD, 7JE, 7JL, 7JY, 7JZ)	567
T-ROC (A11, D11)	567
T-ROC Cabriolet (AC7, AC8)	568
UP! (121, 122, BL1, BL2, BL3, 123)	568





- DE** Produktdetails
- EN** Product details
- ES** Descripción del producto
- FR** Présentation du produit
- IT** Panoramica prodotti

2024



03.0655-0007.2**370007****Pedalwegsensord, Bremspedal**

Einbauposition: Bremskraftverstärker

Bremsssystem: ATE

03.2022-2624.3**010588****Hauptbremszylinder**

Durchmesser 1 [mm]: 22,2

Durchmesser 2 [mm]: 20,6

Anschlussanzahl: 2

MAPP-Code vorhanden:

Gewindemaß 1: 1x M10x1

Gewindemaß 2: 1x M12x1

Länge 1 [mm]: 33,3

Länge 2 [mm]: 113,2

BMW**03.2023-0825.3****010028****Hauptbremszylinder**

Durchmesser 1 [mm]: 23,8

Durchmesser 2 [mm]: 19

Gewindemaß: M10x1

Anschlussanzahl: 3

MAPP-Code vorhanden:

Länge 1 [mm]: 57,4

Länge 2 [mm]: 109,6

MERCEDES-BENZ**03.2023-1066.3****010032****Hauptbremszylinder**

Durchmesser 1 [mm]: 23,8

Durchmesser 2 [mm]: 19

Anschlussanzahl: 2

MAPP-Code vorhanden:

Gewindemaß 1: 1x M10x1

Gewindemaß 2: 1x M12x1

Länge 1 [mm]: 49,8

Länge 2 [mm]: 109

MERCEDES-BENZ

03.2023-1084.3**010591****Hauptbremszylinder**

Durchmesser 1 [mm]: 23,8

Durchmesser 2 [mm]: 20,6

Gewindemaß: M10x1

Anschlussanzahl: 3

MAPP-Code vorhanden:

Bremsystem: ATE

Länge 1 [mm]: 38,3

Länge 2 [mm]: 132,5

VOLVO**03.2023-1741.3****010703****Hauptbremszylinder**

Durchmesser 1 [mm]: 23,8

Durchmesser 2 [mm]: 20,6

Gewindemaß: M12x1

Anschlussanzahl: 4

MAPP-Code vorhanden:

Bremsystem: ATE

Länge 1 [mm]: 12

Länge 2 [mm]: 169,5

MERCEDES-BENZ**03.2023-1812.3****010570****Hauptbremszylinder**

Durchmesser 1 [mm]: 23,8

Durchmesser 2 [mm]: 19

Anschlussanzahl: 3

MAPP-Code vorhanden:

Gewindemaß 1: 1x M10x1

Gewindemaß 2: 2x M12x1

Länge 1 [mm]: 4

Länge 2 [mm]: 147

MERCEDES-BENZ**03.2023-2004.3****010788****Hauptbremszylinder**

Durchmesser 1 [mm]: 23,8

Durchmesser 2 [mm]: 19

Gewindemaß: M12x1

Anschlussanzahl: 4

MAPP-Code vorhanden:

Bremsystem: ATE

Länge 1 [mm]: 4

Länge 2 [mm]: 147

MERCEDES-BENZ

03.2023-2204.3**010644****Hauptbremszylinder**

Durchmesser 1 [mm]: 23,8

Durchmesser 2 [mm]: 22,2

Gewindemaß: M12x1

Anschlussanzahl: 5

MAPP-Code vorhanden:

Bremsystem: ATE

Länge 1 [mm]: 36,9

Länge 2 [mm]: 116,4

BMW**03.2023-2249.3****010869****Hauptbremszylinder**

Durchmesser 1 [mm]: 23,8

Durchmesser 2 [mm]: 22,2

Gewindemaß: M12x1

Anschlussanzahl: 4

MAPP-Code vorhanden:

Bremsystem: ATE

Länge 1 [mm]: 35,9

Länge 2 [mm]: 116,4

BMW**03.2023-2256.3****010870****Hauptbremszylinder**

Durchmesser 1 [mm]: 23,8

Durchmesser 2 [mm]: 22,2

Gewindemaß: M12x1

Anschlussanzahl: 2

MAPP-Code vorhanden:

Bremsystem: ATE

Länge 1 [mm]: 35,9

Länge 2 [mm]: 116,4

BMW**03.2023-2304.3****010646****Hauptbremszylinder**

Durchmesser 1 [mm]: 23,8

Durchmesser 2 [mm]: 22,2

Anschlussanzahl: 2

MAPP-Code vorhanden:

Bremsystem: ATE

Gewindemaß 1: 1x M10x1

Gewindemaß 2: 1x M12x1

Länge 1 [mm]: 32,8

Länge 2 [mm]: 113,2

BMW

03.2023-2344.3**010647****Hauptbremszylinder**

Durchmesser 1 [mm]: 23,8

Durchmesser 2 [mm]: 22,2

Anschlussanzahl: 2

MAPP-Code vorhanden:

Bremsystem: ATE

Gewindemaß 1: 1x M10x1

Gewindemaß 2: 1x M12x1

Länge 1 [mm]: 32,8

Länge 2 [mm]: 113,2

BMW**03.2023-2407.3****010796****Hauptbremszylinder**

Durchmesser 1 [mm]: 23,8

Durchmesser 2 [mm]: 22,2

Gewindemaß: M12x1

Anschlussanzahl: 2

MAPP-Code vorhanden:

Bremsystem: ATE

Länge 1 [mm]: 59,2

Länge 2 [mm]: 105,7

BMW**03.2025-0211.3****010034****Hauptbremszylinder**

Durchmesser 1 [mm]: 25,4

Durchmesser 2 [mm]: 19

Gewindemaß: M10x1

Anschlussanzahl: 3

MAPP-Code vorhanden:

Länge 1 [mm]: 57,8

Länge 2 [mm]: 108

MERCEDES-BENZ**03.2025-1741.3****010705****Hauptbremszylinder**

Durchmesser 1 [mm]: 25,4

Durchmesser 2 [mm]: 20,6

Gewindemaß: M12x1

Anschlussanzahl: 4

MAPP-Code vorhanden:

Bremsystem: ATE

Länge 1 [mm]: 12

Länge 2 [mm]: 169,5

MERCEDES-BENZ

03.2025-1904.3**010797****Hauptbremszylinder**

Durchmesser 1 [mm]: 25,4

Durchmesser 2 [mm]: 22,2

Gewindemaß: M12x1

Anschlussanzahl: 2

MAPP-Code vorhanden:

Bremsystem: ATE

Länge 1 [mm]: 59,2

Länge 2 [mm]: 105,7

BMW**03.2025-2521.3****010959****Hauptbremszylinder**

Durchmesser 1 [mm]: 25,4

Durchmesser 2 [mm]: 22,2

Gewindemaß: M12x1

Anschlussanzahl: 2

MAPP-Code vorhanden:

Bremsystem: ATE

Länge 1 [mm]: 57,6

Länge 2 [mm]: 114,3

MERCEDES-BENZ**03.2025-5826.3****010960****Hauptbremszylinder**

Durchmesser 1 [mm]: 25,4

Durchmesser 2 [mm]: 22,2

Gewindemaß: M12x1

Anschlussanzahl: 2

MAPP-Code vorhanden:

Bremsystem: ATE

Länge 1 [mm]: 35,9

Länge 2 [mm]: 116

BMW**03.2119-3391.3****010058****Hauptbremszylinder**

Durchmesser [mm]: 19

Gewindemaß: M10x1

Anschlussanzahl: 2

MAPP-Code vorhanden:

Bremsystem: ATE

Länge 1 [mm]: 40

Länge 2 [mm]: 114,9

PEUGEOT

03.2120-1897.3**010103****Hauptbremszylinder**

Durchmesser [mm]: 20,6

Gewindemaß: M10x1

Anschlussanzahl: 2

MAPP-Code vorhanden:

Bremsystem: ATE

Länge 1 [mm]: 40

Länge 2 [mm]: 114,9

PEUGEOT**03.2120-2031.3****010106****Hauptbremszylinder**

Durchmesser [mm]: 20,6

Gewindemaß: M10x1

Anschlussanzahl: 4

MAPP-Code vorhanden:

Bremsystem: ATE

Länge 1 [mm]: 32,4

Länge 2 [mm]: 114,9

RENAULT, SEAT**03.2120-2598.3****010116****Hauptbremszylinder**

Durchmesser [mm]: 20,6

Gewindemaß: M10x1

Anschlussanzahl: 4

MAPP-Code vorhanden:

Bremsystem: ATE

Länge 1 [mm]: 20

Länge 2 [mm]: 169,5

OPEL, VAUXHALL**03.2120-3943.3****010532****Hauptbremszylinder**

Durchmesser [mm]: 20,6

Gewindemaß: M10x1

Anschlussanzahl: 4

Material: Aluguss

MAPP-Code vorhanden:

Bremsystem: ATE

Länge 1 [mm]: 35,4

Länge 2 [mm]: 109,7

SEAT, VW

03.2120-4166.3**010452****Hauptbremszylinder**

Durchmesser [mm]: 20,6

Gewindemaß: M10x1

Anschlussanzahl: 4

MAPP-Code vorhanden:

Bremsystem: ATE

Länge 1 [mm]: 29,9

Länge 2 [mm]: 115,9

CITROËN, PEUGEOT**03.2120-4241.3****010524****Hauptbremszylinder**

Durchmesser [mm]: 20,6

Gewindemaß: M10x1

Anschlussanzahl: 2

MAPP-Code vorhanden:

Bremsystem: ATE

Länge 1 [mm]: 29,9

Länge 2 [mm]: 115,9

PEUGEOT**03.2120-4321.3****010525****Hauptbremszylinder**

Durchmesser [mm]: 20,6

Anschlussanzahl: 4

MAPP-Code vorhanden:

Bremsystem: ATE

Gewindemaß 1: 2x M10x1

Gewindemaß 2: 2x M12x1

Länge 1 [mm]: 29,9

Länge 2 [mm]: 115,9

PEUGEOT**03.2120-4381.3****010526****Hauptbremszylinder**

Durchmesser [mm]: 20,6

Anschlussanzahl: 4

MAPP-Code vorhanden:

Bremsystem: ATE

Gewindemaß 1: 2x M10x1

Gewindemaß 2: 2x M12x1

Länge 1 [mm]: 29,9

Länge 2 [mm]: 124,7

RENAULT

03.2120-4441.3**010510****Hauptbremszylinder**

Durchmesser [mm]: 20,6

Gewindemaß: M10x1

Anschlusszahl: 2

MAPP-Code vorhanden:

Bremsystem: ATE

Länge 1 [mm]: 31,5

Länge 2 [mm]: 115,9

RENAULT**03.2120-4461.3****010571****Hauptbremszylinder**

Durchmesser [mm]: 20,6

Anschlusszahl: 2

MAPP-Code vorhanden:

Bremsystem: ATE

Gewindemaß 1: 1x M10x1

Gewindemaß 2: 1x M12x1

Länge 1 [mm]: 31,5

Länge 2 [mm]: 124,7

RENAULT**03.2120-4468.3****010789****Hauptbremszylinder**

Durchmesser [mm]: 20,6

Gewindemaß: M12x1

Anschlusszahl: 2

MAPP-Code vorhanden:

Bremsystem: ATE

Länge 1 [mm]: 31,5

Länge 2 [mm]: 124,7

RENAULT**03.2120-4581.3****010915****Hauptbremszylinder**

Durchmesser [mm]: 20,6

Anschlusszahl: 2

MAPP-Code vorhanden:

Bremsystem: ATE

Gewindemaß 1: M10x1

Gewindemaß 2: M12x1

Länge 1 [mm]: 31,5

Länge 2 [mm]: 162,5

RENAULT

03.2120-4611.3**010937****Hauptbremszylinder**

Durchmesser [mm]: 20,6

Gewindemaß: M10x1

Anschlussanzahl: 2

MAPP-Code vorhanden:

Bremsystem: ATE

Länge 1 [mm]: 22,5

Länge 2 [mm]: 133

DACIA, RENAULT**03.2120-4641.3****010932****Hauptbremszylinder**

Durchmesser [mm]: 20,6

Gewindemaß: M12x1

Anschlussanzahl: 2

MAPP-Code vorhanden:

Bremsystem: ATE

Länge 1 [mm]: 31,5

Länge 2 [mm]: 124,7

RENAULT**03.2122-0264.3****010129****Hauptbremszylinder**

Durchmesser [mm]: 22,2

Anschlussanzahl: 4

MAPP-Code vorhanden:

Bremsystem: ATE

Gewindemaß 1: 2x M10x1

Gewindemaß 2: 2x M12x1

Länge 1 [mm]: 33,1

Länge 2 [mm]: 118

OPEL**03.2122-1001.3****010562****Hauptbremszylinder**

Durchmesser [mm]: 22,2

Anschlussanzahl: 4

MAPP-Code vorhanden:

Gewindemaß 1: 2x M10x1

Gewindemaß 2: 2x M12x1

Länge 1 [mm]: 27,9

Länge 2 [mm]: 131,7

RENAULT

03.2122-1042.3**010137****Hauptbremszylinder**

Durchmesser [mm]: 22,2

Gewindemaß: M10x1

Anschlussanzahl: 4

MAPP-Code vorhanden:

Länge 1 [mm]: 36

Länge 2 [mm]: 109,7

SEAT, VW**03.2122-1144.3****010636****Hauptbremszylinder**

Durchmesser [mm]: 22,2

Gewindemaß: M10x1

Anschlussanzahl: 2

MAPP-Code vorhanden:

Bremsystem: ATE

Länge 1 [mm]: 36

Länge 2 [mm]: 109,7

VW**03.2122-1344.3****010593****Hauptbremszylinder**

Durchmesser [mm]: 22,2

Gewindemaß: M10x1

Anschlussanzahl: 2

MAPP-Code vorhanden:

Bremsystem: ATE

Länge 1 [mm]: 31,5

Länge 2 [mm]: 119,6

SEAT, VW**03.2122-1351.3****010528****Hauptbremszylinder**

Durchmesser [mm]: 22,2

Anschlussanzahl: 2

MAPP-Code vorhanden:

Gewindemaß 1: 1x M10x1

Gewindemaß 2: 1x M12x1

Länge 1 [mm]: 31,5

Länge 2 [mm]: 115,9

CITROËN, PEUGEOT

03.2122-1356.3**010529****Hauptbremszylinder**

Durchmesser [mm]: 22,2

Anschlussanzahl: 4

MAPP-Code vorhanden:

Gewindemaß 1: 2x M10x1

Gewindemaß 2: 2x M12x1

Länge 1 [mm]: 27,9

Länge 2 [mm]: 115,9

CITROËN, PEUGEOT**03.2122-1461.3****010610****Hauptbremszylinder**

Durchmesser [mm]: 22,2

Gewindemaß: M10x1

Anschlussanzahl: 2

MAPP-Code vorhanden:

Bremsystem: ATE

Länge 1 [mm]: 31,5

Länge 2 [mm]: 109,4

PEUGEOT**03.2122-1541.3****010511****Hauptbremszylinder**

Durchmesser [mm]: 22,2

Gewindemaß: M10x1

Anschlussanzahl: 4

MAPP-Code vorhanden:

Länge 1 [mm]: 27,4

Länge 2 [mm]: 119

RENAULT**03.2122-1691.3****010918****Hauptbremszylinder**

Durchmesser [mm]: 22,2

Gewindemaß: M12x10

Anschlussanzahl: 2

MAPP-Code vorhanden:

Bremsystem: ATE

Länge 1 [mm]: 33,1

Länge 2 [mm]: 114,5

TOYOTA

03.2122-1824.3**010892****Hauptbremszylinder**

Durchmesser [mm]: 22,2

Gewindemaß: M12x1

Anschlussanzahl: 3

MAPP-Code vorhanden:

Bremsystem: ATE

Länge 1 [mm]: 42,1

Länge 2 [mm]: 109,3

MINI**03.2122-1853.3****010893****Hauptbremszylinder**

Durchmesser [mm]: 22,2

Gewindemaß: M12x1

Anschlussanzahl: 2

MAPP-Code vorhanden:

Bremsystem: ATE

Länge 1 [mm]: 40,9

Länge 2 [mm]: 109,3

MINI**03.2122-1888.3****010736****Hauptbremszylinder**

Durchmesser [mm]: 22,2

Gewindemaß: M12x1

Anschlussanzahl: 3

MAPP-Code vorhanden:

Bremsystem: ATE

Länge 1 [mm]: 6,4

Länge 2 [mm]: 143,3

AUDI**03.2122-1926.3****010916****Hauptbremszylinder**

Durchmesser [mm]: 22,2

Gewindemaß: M12x1

Anschlussanzahl: 2

MAPP-Code vorhanden:

Bremsystem: ATE

Länge 1 [mm]: 30,5

Länge 2 [mm]: 125,7

RENAULT

03.2122-1942.3**010700****Hauptbremszylinder**

Durchmesser [mm]: 22,2

Gewindemaß: M12x1

Anschlussanzahl: 3

MAPP-Code vorhanden:

Bremsystem: ATE

Länge 1 [mm]: 30,5

Länge 2 [mm]: 117,7

PEUGEOT**03.2122-2031.3****010938****Hauptbremszylinder**

Durchmesser [mm]: 22,2

Gewindemaß: M12x1

Anschlussanzahl: 2

MAPP-Code vorhanden:

Bremsystem: ATE

Länge 1 [mm]: 22,5

Länge 2 [mm]: 132

DACIA, RENAULT**03.2122-2129.3****010799****Hauptbremszylinder**

Durchmesser [mm]: 22,2

Gewindemaß: M12x1

Anschlussanzahl: 2

MAPP-Code vorhanden:

Bremsystem: ATE

Länge 1 [mm]: 36,1

Länge 2 [mm]: 134,9

AUDI, SEAT, SKODA, VW**03.2122-2163.3****010800****Hauptbremszylinder**

Durchmesser [mm]: 22,2

Gewindemaß: M12x1

Anschlussanzahl: 3

MAPP-Code vorhanden:

Bremsystem: ATE

Länge 1 [mm]: 39,8

Länge 2 [mm]: 128,2

CITROËN, FIAT, LANCIA, PEUGEOT

03.2122-2261.3**010964****Hauptbremszylinder**

Durchmesser [mm]: 22,2

Gewindemaß: M12x1

Anschlussanzahl: 2

MAPP-Code vorhanden:

Bremsystem: ATE

Länge 1 [mm]: 21,5

Länge 2 [mm]: 144,4

DACIA, RENAULT**03.2122-9612.3****010159****Hauptbremszylinder**

Durchmesser [mm]: 22,2

Gewindemaß: M10x1

Anschlussanzahl: 4

MAPP-Code vorhanden:

Länge 1 [mm]: 36

Länge 2 [mm]: 103,7

AUDI**03.2123-1121.3****010176****Hauptbremszylinder**

Durchmesser [mm]: 23,8

Anschlussanzahl: 2

MAPP-Code vorhanden:

Gewindemaß 1: 1x M10x1

Gewindemaß 2: 1x M12x1

Länge 1 [mm]: 29,1

Länge 2 [mm]: 118

SAAB**03.2123-1424.3****010637****Hauptbremszylinder**

Durchmesser [mm]: 23,8

Gewindemaß: M10x1

Anschlussanzahl: 2

MAPP-Code vorhanden:

Bremsystem: ATE

Länge 1 [mm]: 34,4

Länge 2 [mm]: 116,6

SEAT, VW

03.2123-1484.3**010595****Hauptbremszylinder**

Durchmesser [mm]: 23,8

Gewindemaß: M12x1

Anschlussanzahl: 2

MAPP-Code vorhanden:

Bremsystem: ATE

Länge 1 [mm]: 31,5

Länge 2 [mm]: 119,6

SEAT, VW**03.2123-1486.3****010488****Hauptbremszylinder**

Durchmesser [mm]: 23,8

Gewindemaß: M12x1

Anschlussanzahl: 2

MAPP-Code vorhanden:

Länge 1 [mm]: 31,5

Länge 2 [mm]: 119,6

RENAULT**03.2123-1526.3****010477****Hauptbremszylinder**

Durchmesser [mm]: 23,8

Gewindemaß: M12x1

Anschlussanzahl: 2

MAPP-Code vorhanden:

Länge 1 [mm]: 31,5

Länge 2 [mm]: 119,6

FORD, SEAT, VW**03.2123-1548.3****010478****Hauptbremszylinder**

Durchmesser [mm]: 23,8

Gewindemaß: M10x1

Anschlussanzahl: 4

MAPP-Code vorhanden:

Länge 1 [mm]: 27,9

Länge 2 [mm]: 114,1

FORD, SEAT, VW

03.2123-1551.3**010512****Hauptbremszylinder**

Durchmesser [mm]: 23,8

Gewindemaß: M10x1

Anschlussanzahl: 4

MAPP-Code vorhanden:

Länge 1 [mm]: 27,9

Länge 2 [mm]: 114,1

RENAULT**03.2123-1581.3****010487****Hauptbremszylinder**

Durchmesser [mm]: 23,8

Gewindemaß: M12x1

Anschlussanzahl: 2

MAPP-Code vorhanden:

Länge 1 [mm]: 33,1

Länge 2 [mm]: 125,8

FORD**03.2123-1622.3****010470****Hauptbremszylinder**

Durchmesser [mm]: 23,8

Anschlussanzahl: 3

MAPP-Code vorhanden:

Gewindemaß 1: 1x M10x1

Gewindemaß 2: 2x M12x1

Länge 1 [mm]: 31,5

Länge 2 [mm]: 119,6

OPEL, VAUXHALL**03.2123-1626.3****010727****Hauptbremszylinder**

Durchmesser [mm]: 23,8

Anschlussanzahl: 3

MAPP-Code vorhanden:

Bremsssystem: ATE

Gewindemaß 1: 1x M10x1

Gewindemaß 2: 2x M12x1

Länge 1 [mm]: 31,5

Länge 2 [mm]: 119,6

SAAB

03.2123-1741.3**010537****Hauptbremszylinder**

Durchmesser [mm]: 23,8

Gewindemaß: M10x1

Anschlussanzahl: 4

MAPP-Code vorhanden:

Bremsystem: ATE

Länge 1 [mm]: 27,9

Länge 2 [mm]: 113,1

RENAULT**03.2123-1824.3****010596****Hauptbremszylinder**

Durchmesser [mm]: 23,8

Gewindemaß: M10x1

Anschlussanzahl: 2

MAPP-Code vorhanden:

Bremsystem: ATE

Länge 1 [mm]: 31,5

Länge 2 [mm]: 119,6

VW**03.2123-2024.3****010597****Hauptbremszylinder**

Durchmesser [mm]: 23,8

Anschlussanzahl: 4

MAPP-Code vorhanden:

Bremsystem: ATE

Gewindemaß 1: 2x M10x1

Gewindemaß 2: 2x M12x1

Länge 1 [mm]: 4,1

Länge 2 [mm]: 137,8

AUDI, SEAT, SKODA, VW**03.2123-2146.3****010572****Hauptbremszylinder**

Durchmesser [mm]: 23,8

Gewindemaß: M10x1

Anschlussanzahl: 2

MAPP-Code vorhanden:

Länge 1 [mm]: 31,5

Länge 2 [mm]: 119

RENAULT

03.2123-2164.3**010599****Hauptbremszylinder**

Durchmesser [mm]: 23,8

Gewindemaß: M12x1

Anschlussanzahl: 2

MAPP-Code vorhanden:

Bremsystem: ATE

Länge 1 [mm]: 40,3

Länge 2 [mm]: 130

VOLVO**03.2123-2243.3****010748****Hauptbremszylinder**

Durchmesser [mm]: 23,8

Gewindemaß: M12x1

Anschlussanzahl: 2

MAPP-Code vorhanden:

Bremsystem: ATE

Länge 1 [mm]: 26,5

Länge 2 [mm]: 124

FORD**03.2123-2581.3****010613****Hauptbremszylinder**

Durchmesser [mm]: 23,8

Gewindemaß: M12x1

Anschlussanzahl: 2

MAPP-Code vorhanden:

Bremsystem: ATE

Länge 1 [mm]: 31,5

Länge 2 [mm]: 119,6

PEUGEOT**03.2123-2621.3****010701****Hauptbremszylinder**

Durchmesser [mm]: 23,8

Gewindemaß: M12x1

Anschlussanzahl: 2

MAPP-Code vorhanden:

Bremsystem: ATE

Länge 1 [mm]: 30,5

Länge 2 [mm]: 124,8

RENAULT

03.2123-2715.3**010802****Hauptbremszylinder**

Durchmesser [mm]: 23,8

Gewindemaß: M12x1

Anschlussanzahl: 3

MAPP-Code vorhanden:

Bremsystem: ATE

Länge 1 [mm]: 34,9

Länge 2 [mm]: 121,4

AUDI, SEAT, SKODA, VW**03.2123-2751.3****011014****Hauptbremszylinder**

Durchmesser [mm]: 23,8

Gewindemaß: M12x1

Anschlussanzahl: 2

MAPP-Code vorhanden:

Bremsystem: ATE

Länge 1 [mm]: 28,2

Länge 2 [mm]: 119

RENAULT**03.2123-2761.3****010886****Hauptbremszylinder**

Durchmesser [mm]: 23,8

Gewindemaß: M12x1

Anschlussanzahl: 2

MAPP-Code vorhanden:

Bremsystem: ATE

Länge 1 [mm]: 30,5

Länge 2 [mm]: 123,7

CITROËN**03.2123-2774.3****010803****Hauptbremszylinder**

Durchmesser [mm]: 23,8

Gewindemaß: M12x1

Anschlussanzahl: 4

MAPP-Code vorhanden:

Bremsystem: ATE

Länge 1 [mm]: 26,6

Länge 2 [mm]: 130,2

AUDI, SEAT, SKODA, VW

03.2123-2781.3**010631****Hauptbremszylinder**

Durchmesser [mm]: 23,8

Anschlussanzahl: 4

MAPP-Code vorhanden:

Bremsystem: ATE

Gewindemaß 1: 2x M10x1

Gewindemaß 2: 2x M12x1

Länge 1 [mm]: 27,9

Länge 2 [mm]: 119,6

CITROËN, PEUGEOT**03.2123-2821.3****010944****Hauptbremszylinder**

Durchmesser [mm]: 23,8

Gewindemaß: M10x1

Anschlussanzahl: 4

MAPP-Code vorhanden:

Bremsystem: ATE

Länge 1 [mm]: 30,7

Länge 2 [mm]: 110

RENAULT**03.2123-2863.3****010790****Hauptbremszylinder**

Durchmesser [mm]: 23,8

Gewindemaß: M10x1

Anschlussanzahl: 2

MAPP-Code vorhanden:

Bremsystem: ATE

Länge 1 [mm]: 29,2

Länge 2 [mm]: 116

NISSAN, RENAULT**03.2123-2923.3****010791****Hauptbremszylinder**

Durchmesser [mm]: 23,8

Gewindemaß: M12x1

Anschlussanzahl: 2

MAPP-Code vorhanden:

Bremsystem: ATE

Länge 1 [mm]: 28,2

Länge 2 [mm]: 119

NISSAN, RENAULT

03.2123-2973.3**010951****Hauptbremszylinder**

Durchmesser [mm]: 23,8

Gewindemaß: M12x1

Anschlussanzahl: 2

MAPP-Code vorhanden:

Bremsystem: ATE

Länge 1 [mm]: 34,9

Länge 2 [mm]: 120,4

SKODA**03.2123-3103.3****010781****Hauptbremszylinder**

Durchmesser [mm]: 23,8

Gewindemaß: M12x1

Anschlussanzahl: 2

MAPP-Code vorhanden:

Bremsystem: ATE

Länge 1 [mm]: 37

Länge 2 [mm]: 116,3

FORD**03.2123-3131.3****010977****Hauptbremszylinder**

Durchmesser [mm]: 23,8

Gewindemaß: M12x1

Anschlussanzahl: 2

MAPP-Code vorhanden:

Bremsystem: ATE

Länge 1 [mm]: 43,2

Länge 2 [mm]: 125,8

CITROËN, PEUGEOT**03.2123-3241.3****010882****Hauptbremszylinder**

Durchmesser [mm]: 23,8

Gewindemaß: M10x1

Anschlussanzahl: 2

MAPP-Code vorhanden:

Bremsystem: ATE

Länge 1 [mm]: 29,2

Länge 2 [mm]: 116

RENAULT

03.2123-3421.3**010933****Hauptbremszylinder**

Durchmesser [mm]: 23,8

Gewindemaß: M12x1

Anschlussanzahl: 2

MAPP-Code vorhanden:

Bremsystem: ATE

Länge 1 [mm]: 39,8

Länge 2 [mm]: 128,2

CITROËN, PEUGEOT**03.2123-3449.3****010808****Hauptbremszylinder**

Durchmesser [mm]: 23,8

Gewindemaß: M12x1

Anschlussanzahl: 2

MAPP-Code vorhanden:

Bremsystem: ATE

Länge 1 [mm]: 36,1

Länge 2 [mm]: 134,9

AUDI, SEAT, SKODA, VW**03.2123-3493.3****010792****Hauptbremszylinder**

Durchmesser [mm]: 23,8

Gewindemaß: M12x1

Anschlussanzahl: 2

MAPP-Code vorhanden:

Bremsystem: ATE

Länge 1 [mm]: 28,2

Länge 2 [mm]: 119

RENAULT**03.2123-3549.3****010809****Hauptbremszylinder**

Durchmesser [mm]: 23,8

Gewindemaß: M12x1

Anschlussanzahl: 2

MAPP-Code vorhanden:

Bremsystem: ATE

Länge 1 [mm]: 36,1

Länge 2 [mm]: 134,9

AUDI

03.2123-3571.3**010962****Hauptbremszylinder**

Durchmesser [mm]: 23,8

Gewindemaß: M10x1

Anschlussanzahl: 2

MAPP-Code vorhanden:

Bremsystem: ATE

Länge 1 [mm]: 35,2

Länge 2 [mm]: 132,8

ALFA ROMEO**03.2123-3593.3****010919****Hauptbremszylinder**

Durchmesser [mm]: 23,8

Gewindemaß: M12x1

Anschlussanzahl: 2

MAPP-Code vorhanden:

Bremsystem: ATE

Länge 1 [mm]: 37

Länge 2 [mm]: 116,3

VOLVO**03.2123-3624.3****010956****Hauptbremszylinder**

Durchmesser [mm]: 23,8

Gewindemaß: M12x1

Anschlussanzahl: 2

MAPP-Code vorhanden:

Bremsystem: ATE

Länge 1 [mm]: 37

Länge 2 [mm]: 116,3

VOLVO**03.2123-3641.3****010963****Hauptbremszylinder**

Durchmesser [mm]: 23,8

Gewindemaß: M10x1

Anschlussanzahl: 2

MAPP-Code vorhanden:

Bremsystem: ATE

Länge 1 [mm]: 36,2

Länge 2 [mm]: 127,8

PEUGEOT

03.2125-0161.3**010920****Hauptbremszylinder**

Durchmesser [mm]: 25,4

Gewindemaß: M10x1

Anschlussanzahl: 2

MAPP-Code vorhanden:

Bremsystem: ATE

Länge 1 [mm]: 9

Länge 2 [mm]: 142

NISSAN**03.2125-0332.3****010952****Hauptbremszylinder**

Durchmesser [mm]: 25,4

Gewindemaß: M12x1

Anschlussanzahl: 2

MAPP-Code vorhanden:

Länge 1 [mm]: 38,2

Länge 2 [mm]: 108

FORD, SEAT, VW**03.2125-0373.3****010810****Hauptbremszylinder**

Durchmesser [mm]: 25,4

Gewindemaß: M12x1

Anschlussanzahl: 2

MAPP-Code vorhanden:

Bremsystem: ATE

Länge 1 [mm]: 64,2

Länge 2 [mm]: 93,5

AUDI, SEAT, SKODA, VW**03.2125-0421.3****010934****Hauptbremszylinder**

Durchmesser [mm]: 25,4

Gewindemaß: M12x1

Anschlussanzahl: 2

MAPP-Code vorhanden:

Bremsystem: ATE

Länge 1 [mm]: 64,2

Länge 2 [mm]: 93,5

CHEVROLET, OPEL, SAAB, VAUXHALL

03.2125-0483.3**010783****Hauptbremszylinder**

Durchmesser [mm]: 25,4

Gewindemaß: M12x1

Anschlussanzahl: 2

MAPP-Code vorhanden:

Bremsystem: ATE

Ergänzungsartikel/Ergänzende Info 2: ohne Bremsflüssigkeitsbehälter

Länge 1 [mm]: 37

Länge 2 [mm]: 117,5

FORD, MAZDA**03.2125-0493.3****010940****Hauptbremszylinder**

Durchmesser [mm]: 25,4

Gewindemaß: M12x1

Anschlussanzahl: 2

MAPP-Code vorhanden:

Bremsystem: ATE

Länge 1 [mm]: 64,2

Länge 2 [mm]: 93,4

AUDI**03.2125-0531.3****010945****Hauptbremszylinder**

Durchmesser [mm]: 25,4

Gewindemaß: M12x1

Anschlussanzahl: 4

MAPP-Code vorhanden:

Bremsystem: ATE

Länge 1 [mm]: 9

Länge 2 [mm]: 142

NISSAN**03.2125-0651.3****010935****Hauptbremszylinder**

Durchmesser [mm]: 25,4

Gewindemaß: M14x1

Anschlussanzahl: 2

MAPP-Code vorhanden:

Bremsystem: ATE

Länge 1 [mm]: 46,6

Länge 2 [mm]: 107,9

FORD

03.2125-0661.3**010917****Hauptbremszylinder**

Durchmesser [mm]: 25,4

Gewindemaß: M14x1

Anschlussanzahl: 2

MAPP-Code vorhanden:

Bremsystem: ATE

Länge 1 [mm]: 37

Länge 2 [mm]: 117,5

FORD**03.2125-0671.3****010965****Hauptbremszylinder**

Durchmesser [mm]: 25,4

Gewindemaß: M12x1

Anschlussanzahl: 2

MAPP-Code vorhanden:

Bremsystem: ATE

Länge 1 [mm]: 35,2

Länge 2 [mm]: 133,8

CITROËN, FIAT, PEUGEOT**03.2125-0676.3****011009****Hauptbremszylinder**

Durchmesser [mm]: 25,4

Gewindemaß: M10x1

Anschlussanzahl: 2

MAPP-Code vorhanden:

Bremsystem: ATE

Ergänzungsartikel/Ergänzende Info 2: ohne Bremsflüssigkeitsbehälter

Länge 1 [mm]: 35,2

Länge 2 [mm]: 133,8

CITROËN, FIAT, PEUGEOT**03.2125-2102.3****010207****Hauptbremszylinder**

Durchmesser [mm]: 25,4

Gewindemaß: M10x1

Anschlussanzahl: 2

MAPP-Code vorhanden:

Länge 1 [mm]: 18,5

Länge 2 [mm]: 158,5

MERCEDES-BENZ

03.2125-5016.3**011010****Hauptbremszylinder**

Durchmesser [mm]: 25,4

Gewindemaß: M12x1

Anschlussanzahl: 2

MAPP-Code vorhanden:

Bremsystem: ATE

Länge 1 [mm]: 18,6

Länge 2 [mm]: 136,2

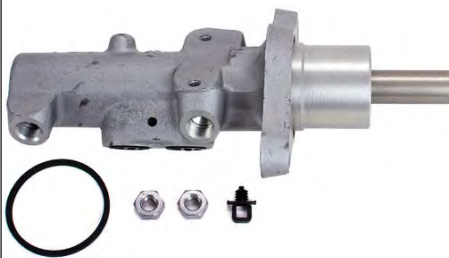
VOLVO**03.2125-5112.3****010966****Hauptbremszylinder**

Durchmesser [mm]: 25,4

Gewindemaß: M10x1

Anschlussanzahl: 2

MAPP-Code vorhanden:

Bremsystem: ATE

Länge 1 [mm]: 36,1

Länge 2 [mm]: 136,1

AUDI**03.2125-7310.3****010743****Hauptbremszylinder**

Durchmesser [mm]: 25,4

Gewindemaß: M12x1

Anschlussanzahl: 2

MAPP-Code vorhanden:

Bremsystem: ATE

Länge 1 [mm]: 11,6

Länge 2 [mm]: 141

MERCEDES-BENZ**03.2125-7637.3****010707****Hauptbremszylinder**

Durchmesser [mm]: 25,4

Gewindemaß: M12x1

Anschlussanzahl: 2

MAPP-Code vorhanden:

Bremsystem: ATE

Länge 1 [mm]: 11,6

Länge 2 [mm]: 140,7

VOLVO

03.2125-7638.3**010738****Hauptbremszylinder**

Durchmesser [mm]: 25,4

Gewindemaß: M12x1

Anschlussanzahl: 2

MAPP-Code vorhanden:

Bremsystem: ATE

Länge 1 [mm]: 11,6

Länge 2 [mm]: 140,7

VOLVO**03.2125-7708.3****010739****Hauptbremszylinder**

Durchmesser [mm]: 25,4

Gewindemaß: M12x1

Anschlussanzahl: 4

MAPP-Code vorhanden:

Bremsystem: ATE

Länge 1 [mm]: 11,6

Länge 2 [mm]: 140,7

VOLVO**03.2125-7713.3****010819****Hauptbremszylinder**

Durchmesser [mm]: 25,4

Gewindemaß: M12x1

Anschlussanzahl: 4

MAPP-Code vorhanden:

Bremsystem: ATE

Länge 1 [mm]: 11,6

Länge 2 [mm]: 140,7

VOLVO**03.2125-7743.3****010921****Hauptbremszylinder**

Durchmesser [mm]: 25,4

Gewindemaß: M10x1

Anschlussanzahl: 2

MAPP-Code vorhanden:

Bremsystem: ATE

Länge 1 [mm]: 11,6

Länge 2 [mm]: 141

VOLVO

03.2125-8111.3**010479****Hauptbremszylinder**

Durchmesser [mm]: 25,4

Gewindemaß: M10x1

Anschlussanzahl: 4

MAPP-Code vorhanden:

Länge 1 [mm]: 31,5

Länge 2 [mm]: 120,8

VW**03.2125-8404.3****010583****Hauptbremszylinder**

Durchmesser [mm]: 25,4

Gewindemaß: M10x1

Anschlussanzahl: 4

MAPP-Code vorhanden:

Bremsystem: ATE

Länge 1 [mm]: 34,6

Länge 2 [mm]: 108

FORD, SEAT, VW**03.2125-9604.3****010581****Hauptbremszylinder**

Durchmesser [mm]: 25,4

Gewindemaß: M10x1

Anschlussanzahl: 5

MAPP-Code vorhanden:

Länge 1 [mm]: 14,6

Länge 2 [mm]: 131,5

FORD, SEAT, VW**03.2125-9704.3****010603****Hauptbremszylinder**

Durchmesser [mm]: 25,4

Gewindemaß: M12x1

Anschlussanzahl: 2

MAPP-Code vorhanden:

Bremsystem: ATE

Länge 1 [mm]: 32,9

Länge 2 [mm]: 125,5

VW

03.2126-3014.3**010811****Hauptbremszylinder**

Durchmesser [mm]: 27

Gewindemaß: M12x1

Anschlussanzahl: 2

MAPP-Code vorhanden:

Bremsystem: ATE

Länge 1 [mm]: 18,7

Länge 2 [mm]: 133,5

PORSCHE, VW**03.2126-3063.3****010812****Hauptbremszylinder**

Durchmesser [mm]: 27

Gewindemaß: M12x1

Anschlussanzahl: 2

MAPP-Code vorhanden:

Bremsystem: ATE

Länge 1 [mm]: 23,3

Länge 2 [mm]: 128,9

AUDI**03.2126-3121.3****010967****Hauptbremszylinder**

Durchmesser [mm]: 27

Gewindemaß: M12x1

Anschlussanzahl: 2

MAPP-Code vorhanden:

Bremsystem: ATE

Länge 1 [mm]: 37,2

Länge 2 [mm]: 135,6

RENAULT**03.2126-3144.3****010941****Hauptbremszylinder**

Durchmesser [mm]: 27

Gewindemaß: M12x1

Anschlussanzahl: 2

MAPP-Code vorhanden:

Bremsystem: ATE

Länge 1 [mm]: 31,1

Länge 2 [mm]: 133,5

VW

03.2126-3196.3**010968****Hauptbremszylinder**

Durchmesser [mm]: 27

Gewindemaß: M12x1

Anschlussanzahl: 2

MAPP-Code vorhanden:

Bremsystem: ATE

Länge 1 [mm]: 55,5

Länge 2 [mm]: 114,3

MERCEDES-BENZ**03.2126-5132.3****011012****Hauptbremszylinder**

Durchmesser [mm]: 27

Gewindemaß: M12x1

Anschlussanzahl: 2

Bremsystem: ATE

Länge 1 [mm]: 37,2

Länge 2 [mm]: 139,8

VW**03.2128-1203.3****010922****Hauptbremszylinder**

Durchmesser [mm]: 28,6

Anschlussanzahl: 2

MAPP-Code vorhanden:

Bremsystem: ATE

Gewindemaß 1: M10x1

Gewindemaß 2: M14x1,5

Länge 1 [mm]: 18,5

Länge 2 [mm]: 204,5

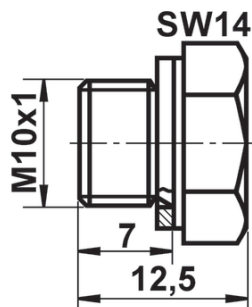
MERCEDES-BENZ**03.3517-0101.2****390322****Verschlusschraube, Hauptbremszylinder**

Länge über Alles [mm]: 12,5

Gewindemaß: M10x1

Länge [mm]: 7,5

Schlüsselweite 1 [mm]: 14

AUDI, SEAT, VW

03.3517-0300.1

390323

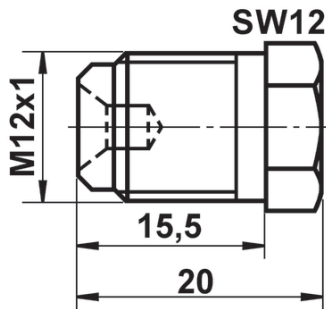
**Verschlusschraube, Hauptbremszylinder**

Länge über Alles [mm]: 20

Gewindemaß: M12x1

Länge [mm]: 13

Schlüsselweite 1 [mm]: 12

Bördelform: E / F

RENAULT

03.3517-5100.1

390326

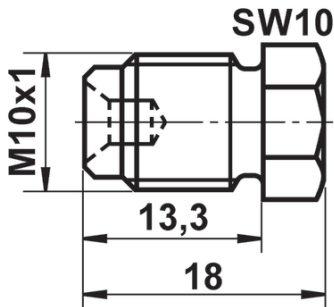
**Verschlusschraube, Hauptbremszylinder**

Länge über Alles [mm]: 18

Gewindemaß: M10x1

Länge [mm]: 11,5

Schlüsselweite 1 [mm]: 10

Bördelform: E / F

FORD, SEAT, VW

03.4055-0013.3

010793

**Hauptbremszylinder**

Durchmesser [mm]: 25,4

Gewindemaß: M12x1

Anschlussanzahl: 2

MAPP-Code vorhanden:

Bremsssystem: ATE

Länge 1 [mm]: 20

Länge 2 [mm]: 106

MERCEDES-BENZ

03.4122-0031.3

010611

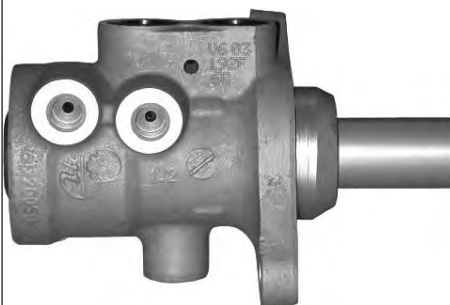
**Hauptbremszylinder**

Durchmesser [mm]: 22,2

Gewindemaß: M10x1

Anschlussanzahl: 4

MAPP-Code vorhanden:

Bremsssystem: ATE

Länge 1 [mm]: 14

Länge 2 [mm]: 85,1

PEUGEOT

03.4122-0041.3**010612****Hauptbremszylinder**

Durchmesser [mm]: 22,2

Gewindemaß: M10x1

Anschlussanzahl: 2

MAPP-Code vorhanden:

Bremsystem: ATE

Länge 1 [mm]: 14

Länge 2 [mm]: 85,1

PEUGEOT**03.4122-0054.3****010813****Hauptbremszylinder**

Durchmesser [mm]: 22,2

Gewindemaß: M12x1

Anschlussanzahl: 2

MAPP-Code vorhanden:

Bremsystem: ATE

Länge 1 [mm]: 13,7

Länge 2 [mm]: 87,9

PEUGEOT**03.4123-0081.3****010585****Hauptbremszylinder**

Durchmesser [mm]: 23,8

Gewindemaß: M12x1

Anschlussanzahl: 3

MAPP-Code vorhanden:

Bremsystem: ATE

Länge 1 [mm]: 5,5

Länge 2 [mm]: 102,3

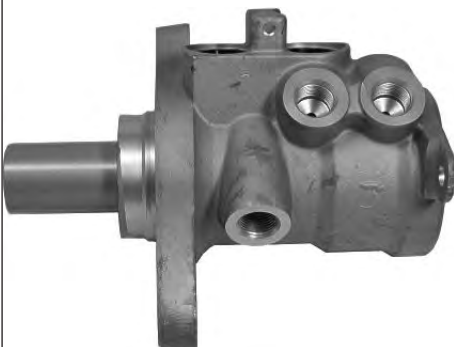
RENAULT**03.4123-0153.3****010659****Hauptbremszylinder**

Durchmesser [mm]: 23,8

Gewindemaß: M12x1

Anschlussanzahl: 3

MAPP-Code vorhanden:

Bremsystem: ATE

Länge 1 [mm]: 12,8

Länge 2 [mm]: 90,3

FORD

03.4125-0014.3**010794****Hauptbremszylinder**

Durchmesser [mm]: 25,4

Gewindemaß: M12x1

Anschlussanzahl: 3

MAPP-Code vorhanden:

Bremsystem: ATE

Länge 1 [mm]: 4,2

Länge 2 [mm]: 105

RENAULT**03.4125-0021.3****010888****Hauptbremszylinder**

Durchmesser [mm]: 25,4

Gewindemaß: M12x1

Anschlussanzahl: 2

MAPP-Code vorhanden:

Bremsystem: ATE

Länge 1 [mm]: 4,2

Länge 2 [mm]: 105

RENAULT**03.4125-0032.3****010955****Hauptbremszylinder**

Durchmesser [mm]: 25,4

Gewindemaß: M12x1

Anschlussanzahl: 3

MAPP-Code vorhanden:

Bremsystem: ATE

Länge 1 [mm]: 12,4

Länge 2 [mm]: 93

JAGUAR**03.4152-0116.3****010814****Hauptbremszylinder**

Durchmesser [mm]: 22,2

Gewindemaß: M12x1

Anschlussanzahl: 2

MAPP-Code vorhanden:

Bremsystem: ATE

Länge 1 [mm]: 27,1

Länge 2 [mm]: 117

VW

03.4152-0153.3

011006



Hauptbremszylinder

Durchmesser [mm]: 22,2

Gewindemaß: M10x1

Anschlussanzahl: 2

MAPP-Code vorhanden:

Bremssystem: ATE

Ergänzungsartikel/Ergänzende Info 2: ohne Bremsflüssigkeitsbehälter

Länge 1 [mm]: 27,9

Länge 2 [mm]: 91

DAIHATSU, TOYOTA

03.4152-0158.3

011007



Hauptbremszylinder

Durchmesser [mm]: 22,2

Gewindemaß: M12x1

Anschlussanzahl: 2

MAPP-Code vorhanden:

Bremssystem: ATE

Ergänzungsartikel/Ergänzende Info 2: ohne Bremsflüssigkeitsbehälter

Länge 1 [mm]: 27,9

Länge 2 [mm]: 91

DAIHATSU, TOYOTA

03.4153-0015.3

011005



Hauptbremszylinder

Durchmesser [mm]: 23,8

Anschlussanzahl: 4

MAPP-Code vorhanden:

Bremssystem: ATE

Gewindemaß 1: 3x M10x1

Gewindemaß 2: 1x M12x1

Ergänzungsartikel/Ergänzende Info 2: ohne Bremsflüssigkeitsbehälter

Länge 1 [mm]: 21,9

Länge 2 [mm]: 93

FORD, MAZDA

03.4153-0063.3

010773

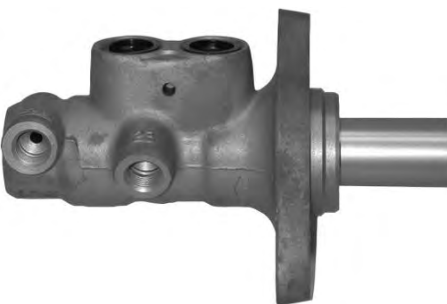

Hauptbremszylinder

Durchmesser [mm]: 23,8

Gewindemaß: M10x1

Anschlussanzahl: 2

MAPP-Code vorhanden:

Bremssystem: ATE

Länge 1 [mm]: 9,9

Länge 2 [mm]: 105,1

RENAULT

03.4153-0173.3**010815****Hauptbremszylinder**

Durchmesser [mm]: 23,8

Gewindemaß: M12x1

Anschlussanzahl: 2

MAPP-Code vorhanden:

Bremsssystem: ATE

Länge 1 [mm]: 31,7

Länge 2 [mm]: 92,2

CITROËN, DS, PEUGEOT**03.4153-0186.3****010816****Hauptbremszylinder**

Durchmesser [mm]: 23,8

Gewindemaß: M12x1

Anschlussanzahl: 2

MAPP-Code vorhanden:

Bremsssystem: ATE

Länge 1 [mm]: 27,1

Länge 2 [mm]: 117

AUDI, SEAT, VW**03.4153-5287.4****010953****Hauptbremszylinder**

Durchmesser [mm]: 23,8

Anschlussanzahl: 2

MAPP-Code vorhanden:

Bremsssystem: ATE

Gewindemaß 1: 1x M10x1

Gewindemaß 2: 1x M12x1

Ergänzungsartikel/Ergänzende Info 2: mit Bremsflüssigkeitsbehälter

Länge 1 [mm]: 21,9

Länge 2 [mm]: 93

FORD, MAZDA**03.4153-5403.3****010994****Hauptbremszylinder**

Durchmesser [mm]: 23,8

Gewindemaß: M12x1

Anschlussanzahl: 2

MAPP-Code vorhanden:

Bremsssystem: ATE

Länge 1 [mm]: 18

Länge 2 [mm]: 123,3

AUDI, SEAT, SKODA, VW

03.4155-0043.3**010795****Hauptbremszylinder**

Durchmesser [mm]: 25,4

Gewindemaß: M12x1

Anschlussanzahl: 2

MAPP-Code vorhanden:

Bremsssystem: ATE

Länge 1 [mm]: 9,9

Länge 2 [mm]: 105

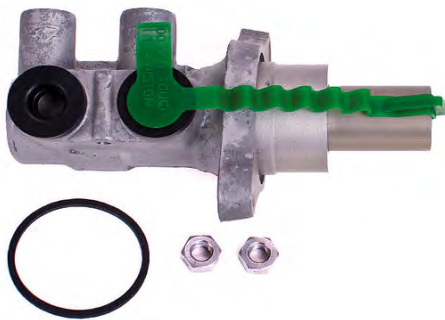
RENAULT**03.4155-0153.3****010927****Hauptbremszylinder**

Durchmesser [mm]: 25,4

Anschlussanzahl: 2

MAPP-Code vorhanden:

Bremsssystem: ATE

Gewindemaß 1: 1x M10x1

Gewindemaß 2: 1x M12x1

Länge 1 [mm]: 24,2

Länge 2 [mm]: 90,7

OPEL, VAUXHALL**03.4155-0156.3****010862****Hauptbremszylinder**

Durchmesser [mm]: 25,4

Gewindemaß: M12x1

Anschlussanzahl: 2

MAPP-Code vorhanden:

Bremsssystem: ATE

Länge 1 [mm]: 24,2

Länge 2 [mm]: 90,7

OPEL, VAUXHALL**03.4155-5141.3****010969****Hauptbremszylinder**

Durchmesser [mm]: 25,4

Gewindemaß: M12x1

Anschlussanzahl: 2

MAPP-Code vorhanden:

Bremsssystem: ATE

Länge 1 [mm]: 15

Länge 2 [mm]: 110,9

MERCEDES-BENZ

03.4155-5451.3**010995****Hauptbremszylinder**

Durchmesser [mm]: 25,4

Gewindemaß: M14x1

Anschlussanzahl: 2

MAPP-Code vorhanden:

Bremsystem: ATE

Länge 1 [mm]: 21,9

Länge 2 [mm]: 93

FORD**03.4155-5456.3****010996****Hauptbremszylinder**

Durchmesser [mm]: 25,4

Gewindemaß: M14x1

Anschlussanzahl: 2

MAPP-Code vorhanden:

Bremsystem: ATE

Länge 1 [mm]: 21,9

Länge 2 [mm]: 93

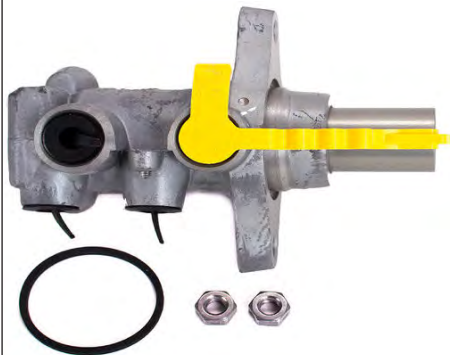
FORD**03.4156-0014.3****010930****Hauptbremszylinder**

Durchmesser [mm]: 27

Gewindemaß: M12x1

Anschlussanzahl: 2

MAPP-Code vorhanden:

Bremsystem: ATE

Ergänzungsartikel/Ergänzende Info 2: ohne Bremsflüssigkeitsbehälter

Länge 1 [mm]: 20

Länge 2 [mm]: 89,5

MERCEDES-BENZ**03.4156-0073.3****010942****Hauptbremszylinder**

Durchmesser [mm]: 27

Gewindemaß: M12x1

Anschlussanzahl: 2

MAPP-Code vorhanden:

Bremsystem: ATE

Länge 1 [mm]: 13,2

Länge 2 [mm]: 102

MERCEDES-BENZ

03.4156-5106.3

010997



Hauptbremszylinder

Durchmesser [mm]: 27

Gewindemaß: M12x1

Anschlusszahl: 2

MAPP-Code vorhanden:

Bremssystem: ATE

Länge 1 [mm]: 11,2

Länge 2 [mm]: 97,7

MERCEDES-BENZ

03.7745-3003.4

300157



Bremskraftverstärker

Kenngroße: T52 Tandem

Durchmesser [Zoll]: 8 / 7

Betriebsart: pneumatisch

Bremssystem: ATE

OPEL, SAAB, VAUXHALL

03.7745-6302.4

300261



Bremskraftverstärker

Kenngroße: T52

Durchmesser [Zoll]: 8

Betriebsart: pneumatisch

Bremssystem: ATE

MERCEDES-BENZ

03.7745-6502.4

300296



Bremskraftverstärker

Kenngroße: T52/4

Durchmesser [Zoll]: 8

Betriebsart: pneumatisch

Bremssystem: ATE

JAGUAR

03.7745-8902.4

300297



Bremskraftverstärker

KenngroÙe: T52/4A

Durchmesser [Zoll]: 8

Betriebsart: pneumatisch

Bremssystem: ATE

MERCEDES-BENZ

03.7750-1332.4

300155



Bremskraftverstärker

KenngroÙe: T52

Durchmesser [Zoll]: 9

Betriebsart: pneumatisch

Bremssystem: ATE

RENAULT

03.7750-6002.4

300134



Bremskraftverstärker

KenngroÙe: T52

Durchmesser [Zoll]: 9

Betriebsart: pneumatisch

Bremssystem: ATE

VW

03.7750-6134.4

300319



Bremskraftverstärker

KenngroÙe: T52

Durchmesser [Zoll]: 9

Betriebsart: pneumatisch

Bremssystem: ATE

PEUGEOT

03.7750-6234.4

300320



Bremskraftverstärker

KenngroÙe: T52

Durchmesser [Zoll]: 9

Betriebsart: pneumatisch

Bremssystem: ATE

PEUGEOT

03.7750-6302.4

300161



Bremskraftverstärker

KenngroÙe: T52

Durchmesser [Zoll]: 9

Betriebsart: pneumatisch

Bremssystem: ATE

SEAT, VW

03.7750-6334.4

300321



Bremskraftverstärker

KenngroÙe: T52/4

Durchmesser [Zoll]: 9

Betriebsart: pneumatisch

Bremssystem: ATE

PEUGEOT

03.7750-7132.4

300255



Bremskraftverstärker

KenngroÙe: T52

Durchmesser [Zoll]: 9

Betriebsart: pneumatisch

Bremssystem: ATE

DAIHATSU, TOYOTA

03.7750-7402.4

300084



Bremskraftverstärker

KenngroÙe: T52

Durchmesser [Zoll]: 9

Betriebsart: pneumatisch

Bremssystem: ATE

VW

03.7750-8732.4

300199



Bremskraftverstärker

KenngroÙe: T52

Durchmesser [Zoll]: 9

Betriebsart: pneumatisch

Bremssystem: ATE

FORD

03.7750-9302.4

300116



Bremskraftverstärker

KenngroÙe: T52/4

Durchmesser [Zoll]: 9

Betriebsart: pneumatisch

Bremssystem: ATE

CITROËN, PEUGEOT

03.7750-9402.4

300117



Bremskraftverstärker

KenngroÙe: T52/4

Durchmesser [Zoll]: 9

Betriebsart: pneumatisch

Bremssystem: ATE

PEUGEOT

03.7755-0132.4

300265



Bremskraftverstärker

KenngroÙe: T52/4 Tandem

Durchmesser [Zoll]: 9 / 8

Betriebsart: pneumatisch

Bremssystem: ATE

VOLVO

03.7755-1432.4

300300



Bremskraftverstärker

KenngroÙe: T52/4 Tandem

Durchmesser [Zoll]: 9 / 8

Betriebsart: pneumatisch

Bremssystem: ATE

FORD



03.7755-1902.4

300138



Bremskraftverstärker

KenngroÙe: T52 Tandem

Durchmesser [Zoll]: 9 / 8

Betriebsart: pneumatisch

Bremssystem: ATE

FORD, SEAT, VW

03.7755-3402.4

300189



Bremskraftverstärker

Durchmesser [Zoll]: 9 / 8

MAPP-Code vorhanden:

Bremssystem: ATE

Abmessungen beachten:

KenngroÙe: T52 Tandem

Betriebsart: pneumatisch

Artikelnummer des empfohlenen Zubehörs: 03.0655-0004.2

VOLVO

03.7755-3532.4

300290



Bremskraftverstärker

KenngroÙe: T52 Tandem

Durchmesser [Zoll]: 9 / 8

Betriebsart: pneumatisch

Bremssystem: ATE

FORD

03.7755-4702.4

300224



Bremskraftverstärker

Durchmesser [Zoll]: 9 / 8

MAPP-Code vorhanden:

Bremssystem: ATE

Abmessungen beachten:

KenngroÙe: T52 Tandem

Betriebsart: pneumatisch

Artikelnummer des empfohlenen Zubehörs: 03.0655-0005.2

VOLVO

03.7755-6302.4

300221



Bremskraftverstärker

KenngroÙe: T52 Tandem

Durchmesser [Zoll]: 9 / 8

Betriebsart: pneumatisch

Bremssystem: ATE

FORD, SEAT, VW

03.7755-8202.4

300301



Bremskraftverstärker

KenngroÙe: T52/4A Tandem

Durchmesser [Zoll]: 9 / 8

Betriebsart: pneumatisch

Bremssystem: ATE

MERCEDES-BENZ

03.7755-9703.4

300239



Bremskraftverstärker

KenngroÙe: T52 Tandem

Durchmesser [Zoll]: 9 / 8

Betriebsart: pneumatisch

Bremssystem: ATE

VOLVO

03.7760-2332.4

300266



Bremskraftverstärker

KenngroÙe: T52

Durchmesser [Zoll]: 10

Betriebsart: pneumatisch

Bremssystem: ATE

FORD

03.7760-2332.4

300267



Bremskraftverstärker

KenngroÙe: T52

Durchmesser [Zoll]: 10

Betriebsart: pneumatisch

Bremssystem: ATE

FORD

03.7760-2702.4

300090



Bremskraftverstärker

KenngroÙe: T52

Durchmesser [Zoll]: 10

Betriebsart: pneumatisch

Bremssystem: ATE

MERCEDES-BENZ

03.7760-3002.4

300120



Bremskraftverstärker

KenngroÙe: T52/4

Durchmesser [Zoll]: 10

Betriebsart: pneumatisch

Bremssystem: ATE

FORD, SEAT, VW

03.7760-3102.4

300139



Bremskraftverstärker

KenngroÙe: T52

Durchmesser [Zoll]: 10

Betriebsart: pneumatisch

Bremssystem: ATE

BMW

03.7760-5502.4

300151



Bremskraftverstärker

KenngroÙe: T52

Durchmesser [Zoll]: 10

Betriebsart: pneumatisch

Bremssystem: ATE

RENAULT



03.7760-5602.4

300121



Bremskraftverstärker

KenngroÙe: T52/4

Durchmesser [Zoll]: 10

Betriebsart: pneumatisch

Bremssystem: ATE

RENAULT

03.7760-8103.4

300240



Bremskraftverstärker

KenngroÙe: T52

Durchmesser [Zoll]: 10

Betriebsart: pneumatisch

Bremssystem: ATE

FORD

03.7765-1002.4

300246



Bremskraftverstärker

KenngroÙe: T52 Tandem

Durchmesser [Zoll]: 10 / 9

Betriebsart: pneumatisch

Bremssystem: ATE

VW

03.7845-0103.4

300268



Bremskraftverstärker

KenngroÙe: T52

Durchmesser [Zoll]: 8

Betriebsart: pneumatisch

Bremssystem: ATE

BMW

03.7848-2002.4

300166



Bremskraftverstärker

Durchmesser [Zoll]: 7 / 8

MAPP-Code vorhanden:

Bremssystem: ATE

Abmessungen beachten:

KenngroÙe: T52/4 Tandem

Betriebsart: pneumatisch

Artikelnummer des empfohlenen Zubehörs: 03.0655-0007.2

MERCEDES-BENZ

03.7848-4003.4

300235



Bremskraftverstärker

KenngroÙe: T52

Durchmesser [Zoll]: 8

Betriebsart: pneumatisch

Bremssystem: ATE

BMW

03.7848-5003.4

300236



Bremskraftverstärker

KenngroÙe: T52

Durchmesser [Zoll]: 8

Betriebsart: pneumatisch

Bremssystem: ATE

BMW



03.7850-0102.4

300180



Bremskraftverstärker

KenngroÙe: T52

Durchmesser [Zoll]: 9

Betriebsart: pneumatisch

Bremssystem: ATE

AUDI

03.7853-0202.4

300181



Bremskraftverstärker

KenngroÙe: T52

Durchmesser [Zoll]: 9

Betriebsart: pneumatisch

Bremssystem: ATE

AUDI

03.7853-0702.4

300195



Bremskraftverstärker

KenngroÙe: T52

Durchmesser [Zoll]: 9

Betriebsart: pneumatisch

Bremssystem: ATE

RENAULT

03.7853-0902.4

300150



Bremskraftverstärker

KenngroÙe: T52

Durchmesser [Zoll]: 9

Betriebsart: pneumatisch

Bremssystem: ATE

CITROËN

03.7853-2102.4

300201



Bremskraftverstärker

KenngroÙe: T52

Durchmesser [Zoll]: 9

Betriebsart: pneumatisch

Bremssystem: ATE

FORD

03.7853-2604.4

300322



Bremskraftverstärker

KenngroÙe: T52

Durchmesser [Zoll]: 9

Betriebsart: pneumatisch

Bremssystem: ATE

PEUGEOT



03.7853-2704.4

300323



Bremskraftverstärker

KenngroÙe: T52

Durchmesser [Zoll]: 9

Betriebsart: pneumatisch

Bremssystem: ATE

PEUGEOT

03.7853-3203.4

300241



Bremskraftverstärker

KenngroÙe: T52

Durchmesser [Zoll]: 9

Betriebsart: pneumatisch

Bremssystem: ATE

DAIHATSU, TOYOTA

03.7853-3902.4

300270



Bremskraftverstärker

KenngroÙe: T52

Durchmesser [Zoll]: 9

Betriebsart: pneumatisch

Bremssystem: ATE

RENAULT

03.7853-4602.4

300302



Bremskraftverstärker

KenngroÙe: T52/5K

Durchmesser [Zoll]: 9

Betriebsart: pneumatisch

Bremssystem: ATE

DACIA, RENAULT

03.7858-0732.4

300272



Bremskraftverstärker

KenngroÙe: T52 Tandem

Durchmesser [Zoll]: 9 / 8

Betriebsart: pneumatisch

Bremssystem: ATE

CHEVROLET, OPEL, SAAB, VAUXHALL

03.7858-2802.4

300303



Bremskraftverstärker

KenngroÙe: T52/5 Tandem

Durchmesser [Zoll]: 9 / 8

Betriebsart: pneumatisch

Bremssystem: ATE

RENAULT

03.7858-3032.4

300257

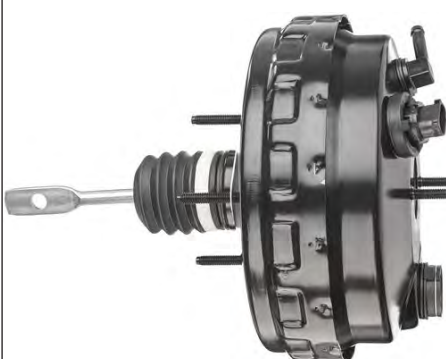

Bremskraftverstärker

Durchmesser [Zoll]: 9 / 8

MAPP-Code vorhanden:

Bremssystem: ATE

Abmessungen beachten:

KenngroÙe: T55/1 Tandem

Betriebsart: pneumatisch

Artikelnummer des empfohlenen Zubehörs: 03.0655-0005.2

VOLVO

03.7858-3302.4

300122



Bremskraftverstärker

KenngroÙe: T55/1 Tandem

Durchmesser [Zoll]: 9 / 8

Betriebsart: pneumatisch

Bremssystem: ATE

FORD, SEAT, VW

03.7858-3532.4

300233



Bremskraftverstärker

Durchmesser [Zoll]: 9 / 8

MAPP-Code vorhanden:

Bremssystem: ATE

Abmessungen beachten:

KenngroÙe: T52 Tandem

Betriebsart: pneumatisch

Artikelnummer des empfohlenen Zubehörs: 03.0655-0005.2

VOLVO

03.7858-3632.4

300234



Bremskraftverstärker

Durchmesser [Zoll]: 9 / 8

MAPP-Code vorhanden:

Bremssystem: ATE

Abmessungen beachten:

KenngroÙe: T52 Tandem

Betriebsart: pneumatisch

Artikelnummer des empfohlenen Zubehörs: 03.0655-0005.2

VOLVO

03.7858-4432.4

300304



Bremskraftverstärker

KenngroÙe: T52/4Z Tandem

Durchmesser [Zoll]: 9 / 8

Betriebsart: pneumatisch

Bremssystem: ATE

AUDI

03.7858-4502.4

300202



Bremskraftverstärker

KenngroÙe: T52 Tandem

Durchmesser [Zoll]: 9 / 8

Betriebsart: pneumatisch

Bremssystem: ATE

AUDI, SEAT

03.7858-4632.4

300273



Bremskraftverstärker

KenngroÙe: T52 Tandem

Durchmesser [Zoll]: 9 / 8

Betriebsart: pneumatisch

Bremssystem: ATE

AUDI

03.7858-5132.4

300276

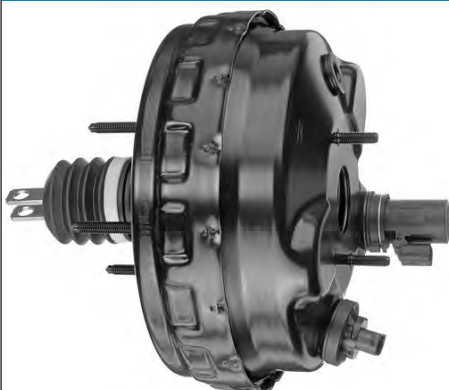

Bremskraftverstärker

KenngroÙe: T55 Tandem

Durchmesser [Zoll]: 9 / 8

Betriebsart: pneumatisch

Bremssystem: ATE

VOLVO

03.7858-9502.4

300205



Bremskraftverstärker

Durchmesser [Zoll]: 9 / 8

MAPP-Code vorhanden:

Bremssystem: ATE

Abmessungen beachten:

KenngroÙe: T55 Tandem

Betriebsart: pneumatisch

Artikelnummer des empfohlenen Zubehörs: 03.0655-0006.2

SEAT, VW

03.7860-0602.4

300141



Bremskraftverstärker

KenngroÙe: T52

Durchmesser [Zoll]: 10

Betriebsart: pneumatisch

Bremssystem: ATE

AUDI, SEAT, VW

03.7860-0702.4

300123



Bremskraftverstärker

KenngroÙe: T52/4

Durchmesser [Zoll]: 10

Betriebsart: pneumatisch

Bremssystem: ATE

BMW

03.7860-1402.4

300228



Bremskraftverstärker

KenngroÙe: T52/4

Durchmesser [Zoll]: 10

Betriebsart: pneumatisch

Bremssystem: ATE

MINI

03.7860-2002.4

300216



Bremskraftverstärker

KenngroÙe: T52

Durchmesser [Zoll]: 10

Betriebsart: pneumatisch

Bremssystem: ATE

CITROËN, PEUGEOT

03.7860-3402.4

300217



Bremskraftverstärker

KenngroÙe: T52

Durchmesser [Zoll]: 10

Betriebsart: pneumatisch

Bremssystem: ATE

CITROËN, PEUGEOT

03.7860-3734.4

300317



Bremskraftverstärker

KenngroÙe: T52

Durchmesser [Zoll]: 10

Betriebsart: pneumatisch

Bremssystem: ATE

CITROËN, DS, PEUGEOT

03.7860-4034.4

300318



Bremskraftverstärker

KenngroÙe: T52

Durchmesser [Zoll]: 10

Betriebsart: pneumatisch

Bremssystem: ATE

CITROËN

03.7860-4203.4

300243



Bremskraftverstärker

KenngroÙe: T52

Durchmesser [Zoll]: 10

Betriebsart: pneumatisch

Bremssystem: ATE

AUDI

03.7860-4432.4

300313



Bremskraftverstärker

KenngroÙe: T52/4

Durchmesser [Zoll]: 10

Betriebsart: pneumatisch

Bremssystem: ATE

CITROËN, PEUGEOT

03.7860-7802.4

300280



Bremskraftverstärker

KenngroÙe: T52

Durchmesser [Zoll]: 10

Betriebsart: pneumatisch

Bremssystem: ATE

CITROËN, PEUGEOT

03.7860-8002.4

300258



Bremskraftverstärker

Kenngröße: T52

Durchmesser [Zoll]: 10

Betriebsart: pneumatisch

Bremssystem: ATE

CITROËN, PEUGEOT

03.7860-8802.4

300291

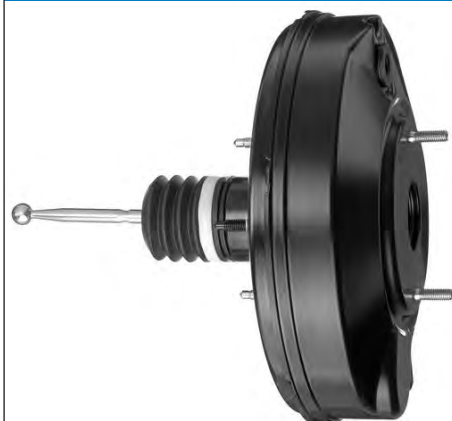

Bremskraftverstärker

Kenngröße: T52

Durchmesser [Zoll]: 10

Betriebsart: pneumatisch

Bremssystem: ATE

VW

03.7863-0332.4

300203



Bremskraftverstärker

Kenngröße: T52

Durchmesser [Zoll]: 10

Betriebsart: pneumatisch

Bremssystem: ATE

FORD

03.7863-0402.4

300124



Bremskraftverstärker

KenngroÙe: T55/1

Durchmesser [Zoll]: 10

Betriebsart: pneumatisch

Bremssystem: ATE

AUDI, SEAT, SKODA, VW

03.7863-1232.4

300314



Bremskraftverstärker

KenngroÙe: T52/5

Durchmesser [Zoll]: 10

Betriebsart: pneumatisch

Bremssystem: ATE

RENAULT

03.7863-2002.4

300126



Bremskraftverstärker

KenngroÙe: T52/5

Durchmesser [Zoll]: 10

Betriebsart: pneumatisch

Bremssystem: ATE

RENAULT

03.7863-2804.4

300324



Bremskraftverstärker

KenngroÙe: T52

Durchmesser [Zoll]: 10

Betriebsart: pneumatisch

Bremssystem: ATE

PEUGEOT

03.7863-3002.4

300223



Bremskraftverstärker

KenngroÙe: T52/5

Durchmesser [Zoll]: 10

Betriebsart: pneumatisch

Bremssystem: ATE

NISSAN

03.7863-3332.4

300308



Bremskraftverstärker

KenngroÙe: T52/6Z

Durchmesser [Zoll]: 10

Betriebsart: pneumatisch

Bremssystem: ATE

AUDI, SEAT, SKODA, VW

03.7863-3502.4

300128



Bremskraftverstärker

KenngroÙe: T52/5

Durchmesser [Zoll]: 10

Betriebsart: pneumatisch

Bremssystem: ATE

AUDI, SKODA, VW



03.7863-3932.4

300288



Bremskraftverstärker

KenngroÙe: T52

Durchmesser [Zoll]: 10

Betriebsart: pneumatisch

Bremssystem: ATE

FORD

03.7863-4502.4

300230



Bremskraftverstärker

KenngroÙe: T52/5

Durchmesser [Zoll]: 10

Betriebsart: pneumatisch

Bremssystem: ATE

RENAULT

03.7863-4832.4

300289



Bremskraftverstärker

KenngroÙe: T52/5

Durchmesser [Zoll]: 10

Betriebsart: pneumatisch

Bremssystem: ATE

VOLVO

03.7868-4102.4

300250



Bremskraftverstärker

KenngroÙe: T52 Tandem

Durchmesser [Zoll]: 10 / 8

Betriebsart: pneumatisch

Bremssystem: ATE

PORSCHE

03.7868-5202.4

300309



Bremskraftverstärker

KenngroÙe: T52/5Z Tandem

Durchmesser [Zoll]: 10 / 8

Betriebsart: pneumatisch

Bremssystem: ATE

RENAULT

03.7868-5802.4

300315



Bremskraftverstärker

KenngroÙe: T52 Tandem

Durchmesser [Zoll]: 10 / 8

Betriebsart: pneumatisch

Bremssystem: ATE

AUDI

03.7868-5902.4

300316



Bremskraftverstärker

KenngroÙe: T52 Tandem

Durchmesser [Zoll]: 10 / 8

Betriebsart: pneumatisch

Bremssystem: ATE

AUDI



03.7870-0602.4

300310



Bremskraftverstärker

KenngroÙe: T52/4Z

Durchmesser [Zoll]: 11

Betriebsart: pneumatisch

Bremssystem: ATE

AUDI

03.7870-1002.4

300282



Bremskraftverstärker

KenngroÙe: T52

Durchmesser [Zoll]: 11

Betriebsart: pneumatisch

Bremssystem: ATE

CITROËN

03.7873-1202.4

300197



Bremskraftverstärker

Durchmesser [Zoll]: 11

Betriebsart: pneumatisch

Bremssystem: ATE

RENAULT

03.7873-4302.4

300312



Bremskraftverstärker

KenngroÙe: T52/6Z

Durchmesser [Zoll]: 11

Betriebsart: pneumatisch

Bremssystem: ATE

VW

03.7873-4402.4

300292



Bremskraftverstärker

KenngroÙe: T52

Durchmesser [Zoll]: 11

Betriebsart: pneumatisch

Bremssystem: ATE

VW

03.7873-4502.4

300284



Bremskraftverstärker

KenngroÙe: T52

Durchmesser [Zoll]: 11

Betriebsart: pneumatisch

Bremssystem: ATE

SEAT, VW



10.6123-0239.3**010335****Hauptbremszylinder**

Durchmesser [mm]: 23,8

Gewindemaß: M10x1

Anschlussanzahl: 2

MAPP-Code vorhanden:

Bremsystem: ATE

Länge 1 [mm]: 43,3

Länge 2 [mm]: 132

BMW**10.6123-0312.3****010457****Hauptbremszylinder**

Durchmesser [mm]: 23,8

Anschlussanzahl: 2

MAPP-Code vorhanden:

Bremsystem: ATE

Gewindemaß 1: 1x M10x1

Gewindemaß 2: 1x M12x1

Länge 1 [mm]: 38

Länge 2 [mm]: 133,2

RENAULT**10.6123-0674.3****010639****Hauptbremszylinder**

Durchmesser [mm]: 23,8

Gewindemaß: M10x1

Anschlussanzahl: 2

MAPP-Code vorhanden:

Bremsystem: ATE

Länge 1 [mm]: 41

Länge 2 [mm]: 127,9

SEAT, VW**10.6350-3902.4****300213****Bremskraftverstärker**

Kenngröße: T52

Durchmesser [Zoll]: 9

Betriebsart: pneumatisch

Bremsystem: ATE

SEAT, VW

10.6350-4002.4

300285

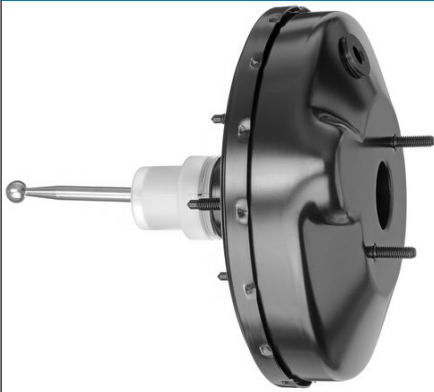

Bremskraftverstärker

KenngroÙe: T52

Durchmesser [Zoll]: 9

Betriebsart: pneumatisch

Bremssystem: ATE

SEAT, VW

10.6360-2002.4

300143



Bremskraftverstärker

KenngroÙe: T52

Durchmesser [Zoll]: 10

Betriebsart: pneumatisch

Bremssystem: ATE

VW

24.2022-1601.3

010340



Hauptbremszylinder

Durchmesser 1 [mm]: 22,2

Durchmesser 2 [mm]: 17,5

GewindemaÙ: M10x1

Anschlussanzahl: 3

MAPP-Code vorhanden:

Länge 1 [mm]: 58

Länge 2 [mm]: 113

MERCEDES-BENZ

24.2023-1601.3

010341



Hauptbremszylinder

Durchmesser [mm]: 23,8

GewindemaÙ: M10x1

Anschlussanzahl: 3

MAPP-Code vorhanden:

Bremssystem: TRW

Länge 1 [mm]: 50

Länge 2 [mm]: 120,5

BMW

24.2023-1701.3**010514****Hauptbremszylinder**

Durchmesser 1 [mm]: 23,8

Durchmesser 2 [mm]: 19

Anschlussanzahl: 2

MAPP-Code vorhanden:

Bremsssystem: TRW

Gewindemaß 1: 1x M10x1

Gewindemaß 2: 1x M12x1

Länge 1 [mm]: 51,5

Länge 2 [mm]: 106

MERCEDES-BENZ**24.2023-1702.3****010534****Hauptbremszylinder**

Durchmesser 1 [mm]: 23,8

Durchmesser 2 [mm]: 19

Gewindemaß: M12x1

Anschlussanzahl: 3

MAPP-Code vorhanden:

Bremsssystem: TRW

Länge 1 [mm]: 24

Länge 2 [mm]: 125

MERCEDES-BENZ**24.2023-1704.3****010635****Hauptbremszylinder**

Durchmesser [mm]: 23,8

Gewindemaß: M12x1

Anschlussanzahl: 3

MAPP-Code vorhanden:

Bremsssystem: TRW

Länge 1 [mm]: 14

Länge 2 [mm]: 135

MERCEDES-BENZ**24.2025-1702.3****010515****Hauptbremszylinder**

Durchmesser 1 [mm]: 25,4

Durchmesser 2 [mm]: 19

Anschlussanzahl: 2

MAPP-Code vorhanden:

Gewindemaß 1: 1x M10x1

Gewindemaß 2: 1x M12x1

Länge 1 [mm]: 51,3

Länge 2 [mm]: 106,2

MERCEDES-BENZ

24.2025-1703.3**010516****Hauptbremszylinder**

Durchmesser 1 [mm]: 25,4

Durchmesser 2 [mm]: 19

Gewindemaß: M12x1

Anschlussanzahl: 2

MAPP-Code vorhanden:

Länge 1 [mm]: 51,3

Länge 2 [mm]: 106,2

MERCEDES-BENZ**24.2025-1704.3****010619****Hauptbremszylinder**

Durchmesser [mm]: 25,4

Anschlussanzahl: 3

MAPP-Code vorhanden:

Gewindemaß 1: 1x M10x1

Gewindemaß 2: 2x M12x1

Länge 1 [mm]: 51,3

Länge 2 [mm]: 107,7

BMW**24.2025-1705.3****010624****Hauptbremszylinder**

Durchmesser 1 [mm]: 25,4

Durchmesser 2 [mm]: 20,6

Anschlussanzahl: 2

MAPP-Code vorhanden:

Bremsssystem: TRW

Gewindemaß 1: 1x M10x1

Gewindemaß 2: 1x M12x1

Länge 1 [mm]: 51,5

Länge 2 [mm]: 108

BMW**24.2025-1706.3****010676****Hauptbremszylinder**

Durchmesser [mm]: 25,4

Anschlussanzahl: 2

MAPP-Code vorhanden:

Gewindemaß 1: 1x M10x1

Gewindemaß 2: 1x M12x1

Länge 1 [mm]: 33

Länge 2 [mm]: 127

NISSAN, OPEL, RENAULT, VAUXHALL

24.2025-1707.3**010691****Hauptbremszylinder**

Durchmesser [mm]: 25,4

Gewindemaß: M12x1

Anschlussanzahl: 2

MAPP-Code vorhanden:

Länge 1 [mm]: 51,7

Länge 2 [mm]: 108,5

BMW**24.2025-1708.3****010692****Hauptbremszylinder**

Durchmesser [mm]: 25,4

Anschlussanzahl: 5

MAPP-Code vorhanden:

Gewindemaß 1: 3x M10x1

Gewindemaß 2: 2x M12x1

Länge 1 [mm]: 33

Länge 2 [mm]: 127

NISSAN, OPEL, RENAULT, VAUXHALL**24.2025-1709.3****010693****Hauptbremszylinder**

Durchmesser [mm]: 25,4

Gewindemaß: M12x1

Anschlussanzahl: 2

MAPP-Code vorhanden:

Länge 1 [mm]: 51,3

Länge 2 [mm]: 108

MERCEDES-BENZ**24.2025-1710.3****010833****Hauptbremszylinder**

Durchmesser [mm]: 25,4

Gewindemaß: M12x1

Anschlussanzahl: 2

MAPP-Code vorhanden:

Bremsystem: TRW

Länge 1 [mm]: 69,3

Länge 2 [mm]: 90

BMW

24.2025-2311.3**011023****Hauptbremszylinder**

Durchmesser 1 [mm]: 25,4

Durchmesser 2 [mm]: 20,6

Gewindemaß: M12x1

Anschlussanzahl: 2

MAPP-Code vorhanden:

Bremsystem: ATE

Länge 1 [mm]: 114,3

Länge 2 [mm]: 57,6

MERCEDES-BENZ**24.2026-1701.3****010746****Hauptbremszylinder**

Durchmesser 2 [mm]: 20,6

Durchmesser [mm]: 27

Gewindemaß: M12x1

Anschlussanzahl: 3

MAPP-Code vorhanden:

Länge 1 [mm]: 51,2

Länge 2 [mm]: 107,3

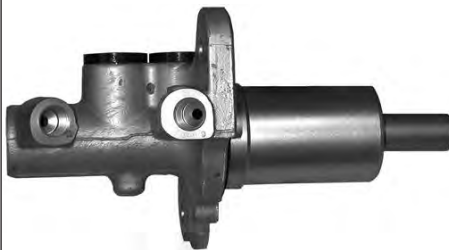
BMW**24.2026-1702.3****010850****Hauptbremszylinder**

Durchmesser 2 [mm]: 22,2

Durchmesser [mm]: 27

Gewindemaß: M12x1

Anschlussanzahl: 2

MAPP-Code vorhanden:

Bremsystem: TRW

Länge 1 [mm]: 69,2

Länge 2 [mm]: 90,5

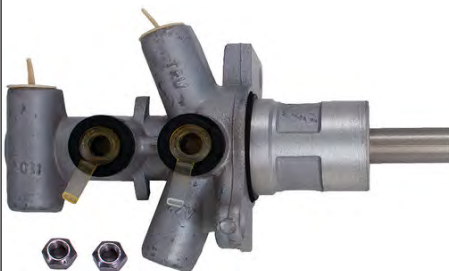
BMW**24.2026-1704.3****010989****Hauptbremszylinder**

Durchmesser 2 [mm]: 20,6

Durchmesser [mm]: 27

Gewindemaß: M14x1

Anschlussanzahl: 2

MAPP-Code vorhanden:

Bremsystem: TRW

Länge 1 [mm]: 51,5

Länge 2 [mm]: 109

LAND ROVER

24.2026-1705.3

010992



Hauptbremszylinder

Durchmesser 2 [mm]: 20,6

Durchmesser [mm]: 27

Gewindemaß: M12x1

Anschlussanzahl: 3

MAPP-Code vorhanden:

Bremssystem: TRW

Länge 1 [mm]: 51

Länge 2 [mm]: 110

BMW, LAND ROVER

24.2026-1706.3

011040



Hauptbremszylinder

Durchmesser 2 [mm]: 22,2

Durchmesser [mm]: 27

Gewindemaß: M12x1

Anschlussanzahl: 2

MAPP-Code vorhanden:

Bremssystem: TRW

Länge 1 [mm]: 69,5

Länge 2 [mm]: 92

BMW

24.2119-0815.3

010347



Hauptbremszylinder

Durchmesser [mm]: 19

Gewindemaß: M10x1,25

Anschlussanzahl: 3

MAPP-Code vorhanden:

Länge 1 [mm]: 12

Länge 2 [mm]: 177,5

FIAT, FSO

24.2119-0826.3

010349



Hauptbremszylinder

Durchmesser [mm]: 19

Gewindemaß: M10x1

Anschlussanzahl: 3

MAPP-Code vorhanden:

Länge 1 [mm]: 12

Länge 2 [mm]: 178,4

FIAT, SEAT

24.2119-0827.3**010350****Hauptbremszylinder**

Durchmesser [mm]: 19

Gewindemaß: M10x1

Anschlussanzahl: 3

MAPP-Code vorhanden:

Länge 1 [mm]: 12

Länge 2 [mm]: 178

FIAT**24.2119-0829.3****010351****Hauptbremszylinder**

Durchmesser [mm]: 19

Gewindemaß: M10x1

Anschlussanzahl: 3

MAPP-Code vorhanden:

Länge 1 [mm]: 9

Länge 2 [mm]: 194,1

LANCIA**24.2119-0831.3****010416****Hauptbremszylinder**

Durchmesser [mm]: 19

Gewindemaß: M10x1,25

Anschlussanzahl: 3

MAPP-Code vorhanden:

Länge 1 [mm]: 9,5

Länge 2 [mm]: 190

LADA**24.2119-0832.3****010417****Hauptbremszylinder**

Durchmesser [mm]: 19

Gewindemaß: M10x1,25

Anschlussanzahl: 3

MAPP-Code vorhanden:

Länge 1 [mm]: 9,5

Länge 2 [mm]: 190

LADA

24.2119-0833.3**010418****Hauptbremszylinder**

Durchmesser [mm]: 19

Gewindemaß: M10x1

Anschlussanzahl: 4

MAPP-Code vorhanden:

Länge 1 [mm]: 10,5

Länge 2 [mm]: 190

FIAT**24.2119-1702.3****010435****Hauptbremszylinder**

Durchmesser [mm]: 19

Gewindemaß: M10x1

Anschlussanzahl: 4

MAPP-Code vorhanden:

Bremsystem: BDX

Länge 1 [mm]: 40

Länge 2 [mm]: 115,2

PEUGEOT**24.2119-1708.3****010543****Hauptbremszylinder**

Durchmesser [mm]: 19

Gewindemaß: M10x1

Anschlussanzahl: 4

MAPP-Code vorhanden:

Bremsystem: BDX

Länge 1 [mm]: 34,5

Länge 2 [mm]: 116,5

CITROËN, PEUGEOT**24.2119-1711.3****010911****Hauptbremszylinder**

Durchmesser [mm]: 19

Gewindemaß: M12x1

Anschlussanzahl: 2

MAPP-Code vorhanden:

Ergänzungsartikel/Ergänzende Info 2: ohne Bremsflüssigkeitsbehälter

Länge 1 [mm]: 41

Länge 2 [mm]: 116,5

SMART

24.2119-1716.3**011120****Hauptbremszylinder**

Gewindemaß 1: M12x1

Durchmesser [mm]: 19

Anschlussanzahl: 4

Ergänzungsartikel/Ergänzende Info 2: ohne Bremsflüssigkeitsbehälter

Bremsystem: FTE

Länge 1 [mm]: 30

Länge 2 [mm]: 140

SKODA, VW**24.2120-0702.3****010361****Hauptbremszylinder**

Durchmesser [mm]: 20,6

Anschlussanzahl: 4

MAPP-Code vorhanden:

Bremsystem: nicht für Delco

Gewindemaß 1: 2x M10x1

Gewindemaß 2: 2x M12x1

Länge 1 [mm]: 16

Länge 2 [mm]: 130

CHEVROLET, OPEL, VAUXHALL**24.2120-0802.3****010363****Hauptbremszylinder**

Durchmesser [mm]: 20,6

Gewindemaß: M10x1

Anschlussanzahl: 3

MAPP-Code vorhanden:

Bremsystem: ATE

Länge 1 [mm]: 39,1

Länge 2 [mm]: 120,4

FIAT**24.2120-0803.3****010415****Hauptbremszylinder**

Durchmesser [mm]: 20,6

Gewindemaß: M10x1,25

Anschlussanzahl: 4

MAPP-Code vorhanden:

Länge 1 [mm]: 9

Länge 2 [mm]: 178,5

LADA

24.2120-1704.3**010429****Hauptbremszylinder**

Durchmesser [mm]: 20,6

Gewindemaß: M10x1

Anschlussanzahl: 4

MAPP-Code vorhanden:

Bremsystem: BDX

Länge 1 [mm]: 40

Länge 2 [mm]: 114,2

PEUGEOT**24.2120-1706.3****010262****Hauptbremszylinder**

Durchmesser [mm]: 20,6

Gewindemaß: M10x1

Anschlussanzahl: 4

MAPP-Code vorhanden:

Länge 1 [mm]: 40,1

Länge 2 [mm]: 118

RENAULT**24.2120-1710.3****010468****Hauptbremszylinder**

Durchmesser [mm]: 20,6

Gewindemaß: M10x1

Anschlussanzahl: 4

MAPP-Code vorhanden:

Länge 1 [mm]: 33,5

Länge 2 [mm]: 130

FIAT, LANCIA**24.2120-1714.3****010455****Hauptbremszylinder**

Gewindemaß 1: 1x M10x1

Durchmesser [mm]: 20,6

Gewindemaß 2: 1x M12x1

Anschlussanzahl: 2

Länge 1 [mm]: 16

Länge 2 [mm]: 130,5

CHEVROLET, OPEL, VAUXHALL

24.2120-1721.3**010553****Hauptbremszylinder**

Durchmesser [mm]: 20,6

Anschlussanzahl: 3

MAPP-Code vorhanden:

Gewindemaß 1: 2x M10x1

Gewindemaß 2: 1x M12x1

Länge 1 [mm]: 51,3

Länge 2 [mm]: 143,8

BMW**24.2120-1722.3****010544****Hauptbremszylinder**

Durchmesser [mm]: 20,6

Gewindemaß: M10x1

Anschlussanzahl: 4

MAPP-Code vorhanden:

Länge 1 [mm]: 34,5

Länge 2 [mm]: 116,5

CITROËN, PEUGEOT**24.2120-1723.3****010545****Hauptbremszylinder**

Durchmesser [mm]: 20,6

Gewindemaß: M10x1

Anschlussanzahl: 2

MAPP-Code vorhanden:

Bremsssystem: BDX

Länge 1 [mm]: 34,5

Länge 2 [mm]: 118

RENAULT**24.2120-1725.3****010579****Hauptbremszylinder**

Durchmesser [mm]: 20,6

Gewindemaß: M10x1

Anschlussanzahl: 2

MAPP-Code vorhanden:

Bremsssystem: BDX

Länge 1 [mm]: 34,5

Länge 2 [mm]: 118

RENAULT

24.2120-1726.3**010564****Hauptbremszylinder**

Durchmesser [mm]: 20,6

Anschlussanzahl: 2

Bremsystem: BDX

Gewindemaß 1: 1x M10x1

Gewindemaß 2: 1x M12x1

Länge 1 [mm]: 33

Länge 2 [mm]: 120

PEUGEOT**24.2120-1730.3****010678****Hauptbremszylinder**

Durchmesser [mm]: 20,6

Gewindemaß: M10x1

Anschlussanzahl: 2

MAPP-Code vorhanden:

Länge 1 [mm]: 34,5

Länge 2 [mm]: 116,2

OPEL, SUBARU, SUZUKI, VAUXHALL**24.2120-1734.3****010702****Hauptbremszylinder**

Durchmesser [mm]: 20,6

Gewindemaß: M12x1

Anschlussanzahl: 2

MAPP-Code vorhanden:

Länge 1 [mm]: 38,5

Länge 2 [mm]: 139,5

SEAT, SKODA, VW**24.2120-1736.3****010732****Hauptbremszylinder**

Durchmesser [mm]: 20,6

Gewindemaß: M12x1

Anschlussanzahl: 4

MAPP-Code vorhanden:

Länge 1 [mm]: 28,1

Länge 2 [mm]: 138,2

SEAT, SKODA, VW

24.2120-1737.3

010757



Hauptbremszylinder

Durchmesser [mm]: 20,6

Anschlussanzahl: 4

MAPP-Code vorhanden:

Gewindemaß 1: 2x M10x1

Gewindemaß 2: 2x M12x1

Länge 1 [mm]: 30

Länge 2 [mm]: 117

PEUGEOT

24.2120-1738.3

010759



Hauptbremszylinder

Durchmesser [mm]: 20,6

Anschlussanzahl: 4

MAPP-Code vorhanden:

Bremssystem: TRW

Gewindemaß 1: 2x M10x1

Gewindemaß 2: 2x M12x1

Länge 1 [mm]: 51

Länge 2 [mm]: 139

NISSAN, RENAULT

24.2120-1740.3

010764



Hauptbremszylinder

Durchmesser [mm]: 20,6

Gewindemaß: M12x1

Anschlussanzahl: 4

MAPP-Code vorhanden:

Bremssystem: TRW

Länge 1 [mm]: 51

Länge 2 [mm]: 139

NISSAN, RENAULT

24.2120-1741.3

010775



Hauptbremszylinder

Durchmesser [mm]: 20,6

Gewindemaß: M12x1

Anschlussanzahl: 4

MAPP-Code vorhanden:

Länge 1 [mm]: 24

Länge 2 [mm]: 132

CITROËN

24.2120-1742.3**010776****Hauptbremszylinder**

Durchmesser [mm]: 20,6

Gewindemaß: M10x1

Anschlussanzahl: 4

MAPP-Code vorhanden:

Länge 1 [mm]: 33

Länge 2 [mm]: 125

FIAT**24.2120-1743.3****010777****Hauptbremszylinder**

Durchmesser [mm]: 20,6

Gewindemaß: M10x1

Anschlussanzahl: 2

MAPP-Code vorhanden:

Länge 1 [mm]: 33

Länge 2 [mm]: 125

FIAT**24.2120-1744.3****010820****Hauptbremszylinder**

Durchmesser [mm]: 20,6

Gewindemaß: M10x1

Anschlussanzahl: 4

MAPP-Code vorhanden:

Länge 1 [mm]: 36,5

Länge 2 [mm]: 132,5

FIAT**24.2120-1746.3****010835****Hauptbremszylinder**

Durchmesser [mm]: 20,6

Gewindemaß: M12x1

Anschlussanzahl: 2

MAPP-Code vorhanden:

Bremsystem: BOS

Länge 1 [mm]: 33

Länge 2 [mm]: 130,5

FIAT

24.2120-1747.3**010836****Hauptbremszylinder**

Durchmesser [mm]: 20,6

Gewindemaß: M10x1

Anschlussanzahl: 2

MAPP-Code vorhanden:

Bremsystem: BOS

Länge 1 [mm]: 36,5

Länge 2 [mm]: 134

FIAT**24.2120-1748.3****010894****Hauptbremszylinder**

Durchmesser [mm]: 20,6

Gewindemaß: M12x1

Anschlussanzahl: 2

MAPP-Code vorhanden:

Bremsystem: TRW

Länge 1 [mm]: 25

Länge 2 [mm]: 162

OPEL, RENAULT, VAUXHALL**24.2120-1749.3****010903****Hauptbremszylinder**

Durchmesser [mm]: 20,6

Länge über Alles [mm]: 245

Gewindemaß: M10x1

Anschlussanzahl: 2

MAPP-Code vorhanden:

Bremsystem: TRW

TOYOTA**24.2120-1751.3****010909****Hauptbremszylinder**

Durchmesser [mm]: 20,6

Gewindemaß: M10x1

Anschlussanzahl: 2

MAPP-Code vorhanden:

Länge 1 [mm]: 15,5

Länge 2 [mm]: 153,5

HONDA

24.2120-1752.3**010928****Hauptbremszylinder**

Durchmesser [mm]: 20,6

Gewindemaß: M10x1

Anschlussanzahl: 2

MAPP-Code vorhanden:

Bremsystem: ATE

Ergänzungsartikel/Ergänzende Info 2: mit Bremsflüssigkeitsbehälter

Länge 1 [mm]: 26

Länge 2 [mm]: 157

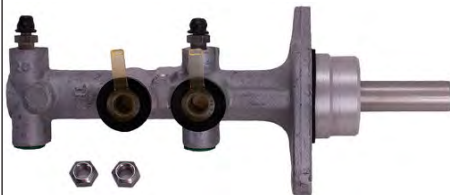
HONDA**24.2120-1753.3****010946****Hauptbremszylinder**

Durchmesser [mm]: 20,6

Anschlussanzahl: 4

MAPP-Code vorhanden:

Bremsystem: TRW

Gewindemaß 1: 2x M10x1

Gewindemaß 2: 2x M12x1

Länge 1 [mm]: 25

Länge 2 [mm]: 160

OPEL, RENAULT, VAUXHALL**24.2120-1754.3****010949****Hauptbremszylinder**

Durchmesser [mm]: 20,6

Anschlussanzahl: 2

MAPP-Code vorhanden:

Gewindemaß 1: M10x1

Gewindemaß 2: M12x1

Länge 1 [mm]: 23,5

Länge 2 [mm]: 107,5

DACIA, RENAULT**24.2120-1755.3****010974****Hauptbremszylinder**

Durchmesser [mm]: 20,6

Gewindemaß: M10x1

Anschlussanzahl: 2

MAPP-Code vorhanden:

Ergänzungsartikel/Ergänzende Info 2: ohne Bremsflüssigkeitsbehälter

Länge 1 [mm]: 16,5

Länge 2 [mm]: 129,5

CHEVROLET, DAEWOO

24.2120-1756.3**010975****Hauptbremszylinder**

Durchmesser [mm]: 20,6

Gewindemaß: M10x1

Anschlussanzahl: 2

MAPP-Code vorhanden:

Ergänzungsartikel/Ergänzende Info 2: ohne Bremsflüssigkeitsbehälter

Länge 1 [mm]: 29,5

Länge 2 [mm]: 152

MAZDA**24.2120-1757.3****010976****Hauptbremszylinder**

Durchmesser [mm]: 20,6

Gewindemaß: M10x1

Anschlussanzahl: 2

MAPP-Code vorhanden:

Ergänzungsartikel/Ergänzende Info 2: ohne Bremsflüssigkeitsbehälter

Länge 1 [mm]: 23

Länge 2 [mm]: 172

TOYOTA**24.2120-1759.3****011083****Hauptbremszylinder**

Durchmesser [mm]: 20,6

Gewindemaß: M12x1

Anschlussanzahl: 2

Material: Aluguss

MAPP-Code vorhanden:

Ergänzungsartikel/Ergänzende Info 2: ohne Bremsflüssigkeitsbehälter

Länge 1 [mm]: 19

Länge 2 [mm]: 173,3

HONDA**24.2120-1760.3****011018****Hauptbremszylinder**

Durchmesser [mm]: 20,6

Gewindemaß: M14x1,5

Anschlussanzahl: 2

MAPP-Code vorhanden:

Ergänzungsartikel/Ergänzende Info 2: ohne Bremsflüssigkeitsbehälter

Länge 1 [mm]: 13,5

Länge 2 [mm]: 169,5

TOYOTA

24.2120-1761.3

011090

**Hauptbremszylinder**

Durchmesser [mm]: 20,6

Gewindemaß: M12x1

Anschlussanzahl: 2

MAPP-Code vorhanden:

Ergänzungsartikel/Ergänzende Info 2: ohne Bremsflüssigkeitsbehälter

Länge 1 [mm]: 28

Länge 2 [mm]: 105,4

MAZDA

24.2120-1762.3

011002

**Hauptbremszylinder**

Durchmesser [mm]: 20,6

Anschlussanzahl: 4

MAPP-Code vorhanden:

Gewindemaß 1: 2x M10x1

Gewindemaß 2: 2x M12x1

Ergänzungsartikel/Ergänzende Info 2: ohne Bremsflüssigkeitsbehälter

Länge 1 [mm]: 23,5

Länge 2 [mm]: 107,5

DACIA, RENAULT

24.2120-1765.3

011003

**Hauptbremszylinder**

Durchmesser [mm]: 20,6

Gewindemaß: M10x1

Anschlussanzahl: 2

MAPP-Code vorhanden:

Ergänzungsartikel/Ergänzende Info 2: ohne Bremsflüssigkeitsbehälter

Länge 1 [mm]: 16

Länge 2 [mm]: 129,5

CHEVROLET, DAEWOO

24.2120-1766.3

011000

**Hauptbremszylinder**

Durchmesser [mm]: 20,6

Gewindemaß: M10x1

Anschlussanzahl: 2

MAPP-Code vorhanden:

Ergänzungsartikel/Ergänzende Info 2: ohne Bremsflüssigkeitsbehälter

Länge 1 [mm]: 33

Länge 2 [mm]: 116,5

TOYOTA

24.2120-1767.3**011004****Hauptbremszylinder**

Durchmesser [mm]: 20,6

Gewindemaß: M10x1

Anschlussanzahl: 2

MAPP-Code vorhanden:

Ergänzungsartikel/Ergänzende Info 2: ohne Bremsflüssigkeitsbehälter

Länge 1 [mm]: 38,5

Länge 2 [mm]: 113,5

HYUNDAI**24.2120-1768.3****011041****Hauptbremszylinder**

Durchmesser [mm]: 20,6

Gewindemaß: M12x1

Anschlussanzahl: 2

MAPP-Code vorhanden:

Ergänzungsartikel/Ergänzende Info 2: ohne Bremsflüssigkeitsbehälter

Länge 1 [mm]: 26

Länge 2 [mm]: 143

SKODA**24.2120-1770.3****011066****Hauptbremszylinder**

Durchmesser [mm]: 20,6

Gewindemaß: M10x1

Anschlussanzahl: 4

MAPP-Code vorhanden:

Bremsystem: ATE

Ergänzungsartikel/Ergänzende Info 2: ohne Bremsflüssigkeitsbehälter

Länge 1 [mm]: 32,5

Länge 2 [mm]: 117,5

FIAT**24.2122-1588.3****011028****Hauptbremszylinder**

Durchmesser [mm]: 22,2

Gewindemaß: M10x1

Anschlussanzahl: 4

MAPP-Code vorhanden:

Bremsystem: ATE

Ergänzungsartikel/Ergänzende Info 2: ohne Druckregler

Länge 1 [mm]: 27,4

Länge 2 [mm]: 124

FORD

24.2122-1703.3**010422****Hauptbremszylinder**

Durchmesser [mm]: 22,2

Gewindemaß: M10x1

Anschlussanzahl: 4

MAPP-Code vorhanden:

Länge 1 [mm]: 36,2

Länge 2 [mm]: 115,2

CITROËN, FIAT, PEUGEOT**24.2122-1705.3****010434****Hauptbremszylinder**

Durchmesser [mm]: 22,2

Gewindemaß: M10x1

Anschlussanzahl: 4

MAPP-Code vorhanden:

Länge 1 [mm]: 36,5

Länge 2 [mm]: 118

PEUGEOT**24.2122-1707.3****010438****Hauptbremszylinder**

Durchmesser [mm]: 22,2

Gewindemaß: M10x1

Anschlussanzahl: 4

MAPP-Code vorhanden:

Länge 1 [mm]: 36,5

Länge 2 [mm]: 128

RENAULT**24.2122-1708.3****010437****Hauptbremszylinder**

Durchmesser [mm]: 22,2

Gewindemaß: M10x1

Anschlussanzahl: 2

MAPP-Code vorhanden:

Länge 1 [mm]: 35

Länge 2 [mm]: 131,5

CITROËN, FIAT, PEUGEOT

24.2122-1715.3**010481****Hauptbremszylinder**

Durchmesser [mm]: 22,2

Gewindemaß: M10x1

Anschlussanzahl: 5

MAPP-Code vorhanden:

Länge 1 [mm]: 19

Länge 2 [mm]: 167

CITROËN, FIAT, PEUGEOT**24.2122-1716.3****010485****Hauptbremszylinder**

Durchmesser [mm]: 22,2

Gewindemaß: M10x1

Anschlussanzahl: 4

MAPP-Code vorhanden:

Länge 1 [mm]: 36

Länge 2 [mm]: 132

ALFA ROMEO, FIAT, LANCIA**24.2122-1718.3****010517****Hauptbremszylinder**

Durchmesser [mm]: 22,2

Gewindemaß: M10x1

Anschlussanzahl: 2

MAPP-Code vorhanden:

Länge 1 [mm]: 36,5

Länge 2 [mm]: 117

MITSUBISHI, VOLVO**24.2122-1724.3****010561****Hauptbremszylinder**

Durchmesser [mm]: 22,2

Anschlussanzahl: 2

MAPP-Code vorhanden:

Gewindemaß 1: 1x M10x1

Gewindemaß 2: 1x M12x1

Länge 1 [mm]: 23,5

Länge 2 [mm]: 122,5

OPEL, VAUXHALL

24.2122-1727.3**010586****Hauptbremszylinder**

Durchmesser [mm]: 22,2

Anschlussanzahl: 4

MAPP-Code vorhanden:

Bremsystem: BDX

Gewindemaß 1: 2x M10x1

Gewindemaß 2: 2x M12x1

Länge 1 [mm]: 34,5

Länge 2 [mm]: 115,5

NISSAN, RENAULT**24.2122-1731.3****010656****Hauptbremszylinder**

Durchmesser [mm]: 22,2

Gewindemaß: M10x1

Anschlussanzahl: 4

MAPP-Code vorhanden:

Länge 1 [mm]: 36

Länge 2 [mm]: 150,2

SKODA, VW**24.2122-1733.3****010668****Hauptbremszylinder**

Durchmesser [mm]: 22,2

Anschlussanzahl: 4

MAPP-Code vorhanden:

Gewindemaß 1: 2x M10x1

Gewindemaß 2: 2x M12x1

Länge 1 [mm]: 34,5

Länge 2 [mm]: 165

CITROËN, PEUGEOT**24.2122-1740.3****010711****Hauptbremszylinder**

Durchmesser [mm]: 22,2

Anschlussanzahl: 2

MAPP-Code vorhanden:

Bremsystem: DEL

Gewindemaß 1: 1x M10x1

Gewindemaß 2: 1x M12x1

Länge 1 [mm]: 27,5

Länge 2 [mm]: 118,5

OPEL, VAUXHALL

24.2122-1741.3**010695****Hauptbremszylinder**

Durchmesser [mm]: 22,2

Gewindemaß: M10x1

Anschlussanzahl: 4

MAPP-Code vorhanden:

Länge 1 [mm]: 36

Länge 2 [mm]: 115

CITROËN, PEUGEOT**24.2122-1743.3****010712****Hauptbremszylinder**

Durchmesser [mm]: 22,2

Anschlussanzahl: 4

MAPP-Code vorhanden:

Gewindemaß 1: 2x M10x1

Gewindemaß 2: 2x M12x1

Länge 1 [mm]: 29

Länge 2 [mm]: 117

CITROËN**24.2122-1750.3****010740****Hauptbremszylinder**

Durchmesser [mm]: 22,2

Gewindemaß: M10x1

Anschlussanzahl: 4

MAPP-Code vorhanden:

Länge 1 [mm]: 29,5

Länge 2 [mm]: 120,5

FIAT**24.2122-1761.3****010822****Hauptbremszylinder**

Durchmesser [mm]: 22,2

Gewindemaß: M10x1

Anschlussanzahl: 2

MAPP-Code vorhanden:

Länge 1 [mm]: 16

Länge 2 [mm]: 154,3

HYUNDAI

24.2122-1762.3**010837****Hauptbremszylinder**

Durchmesser [mm]: 22,2

Gewindemaß: M10x1

Anschlussanzahl: 2

MAPP-Code vorhanden:

Länge 1 [mm]: 30

Länge 2 [mm]: 131

FIAT, LANCIA**24.2122-1764.3****010851****Hauptbremszylinder**

Durchmesser [mm]: 22,2

Gewindemaß: M12x1

Anschlussanzahl: 2

MAPP-Code vorhanden:

Bremsystem: BOS

Länge 1 [mm]: 26,5

Länge 2 [mm]: 138

CITROËN, PEUGEOT**24.2122-1765.3****010839****Hauptbremszylinder**

Durchmesser [mm]: 22,2

Gewindemaß: M10x1

Anschlussanzahl: 2

MAPP-Code vorhanden:

Länge 1 [mm]: 16

Länge 2 [mm]: 154

HYUNDAI**24.2122-1766.3****010840****Hauptbremszylinder**

Durchmesser [mm]: 22,2

Gewindemaß: M12x1

Anschlussanzahl: 2

MAPP-Code vorhanden:

Bremsystem: TRW

Länge 1 [mm]: 25

Länge 2 [mm]: 135

CITROËN, PEUGEOT

24.2122-1767.3**010841****Hauptbremszylinder**

Durchmesser [mm]: 22,2

Gewindemaß: M12x1

Anschlussanzahl: 3

MAPP-Code vorhanden:

Bremsystem: TRW

Ergänzungsartikel/Ergänzende Info 2: ohne Drucksensor

Länge 1 [mm]: 25

Länge 2 [mm]: 135

CITROËN, PEUGEOT**24.2122-1768.3****010853****Hauptbremszylinder**

Durchmesser [mm]: 22,2

Gewindemaß: M12x1

Anschlussanzahl: 2

MAPP-Code vorhanden:

Länge 1 [mm]: 30

Länge 2 [mm]: 131

FIAT, LANCIA**24.2122-1770.3****010898****Hauptbremszylinder**

Durchmesser [mm]: 22,2

Gewindemaß: M12x1

Anschlussanzahl: 2

MAPP-Code vorhanden:

Bremsystem: TRW

Länge 1 [mm]: 45

Länge 2 [mm]: 114

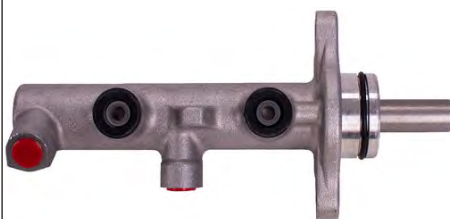
MITSUBISHI, SMART**24.2122-1774.3****010987****Hauptbremszylinder**

Durchmesser [mm]: 22,2

Gewindemaß: M12x1

Anschlussanzahl: 2

MAPP-Code vorhanden:

Ergänzungsartikel/Ergänzende Info 2: ohne Bremsflüssigkeitsbehälter

Länge 1 [mm]: 19

Länge 2 [mm]: 161

NISSAN

24.2122-1775.3**010981****Hauptbremszylinder**

Durchmesser [mm]: 22,2

Gewindemaß: M10x1

Anschlussanzahl: 4

MAPP-Code vorhanden:

Ergänzungsartikel/Ergänzende Info 2: ohne Bremsflüssigkeitsbehälter

Länge 1 [mm]: 16,5

Länge 2 [mm]: 175,5

FORD**24.2122-1776.3****011001****Hauptbremszylinder**

Durchmesser [mm]: 22,2

Gewindemaß: M10x1

Anschlussanzahl: 3

MAPP-Code vorhanden:

Ergänzungsartikel/Ergänzende Info 2: ohne Bremsflüssigkeitsbehälter

Länge 1 [mm]: 29,5

Länge 2 [mm]: 111,5

SUZUKI**24.2122-1777.3****011056****Hauptbremszylinder**

Durchmesser [mm]: 22,2

Gewindemaß: M10x1

Anschlussanzahl: 2

MAPP-Code vorhanden:

Ergänzungsartikel/Ergänzende Info 2: ohne Bremsflüssigkeitsbehälter

Länge 1 [mm]: 33

Länge 2 [mm]: 138

FIAT**24.2122-1779.3****011064****Hauptbremszylinder**

Durchmesser [mm]: 22,2

Gewindemaß: M10x1

Anschlussanzahl: 2

Material: Aluguss

MAPP-Code vorhanden:

Ergänzungsartikel/Ergänzende Info 2: ohne Bremsflüssigkeitsbehälter

Länge 1 [mm]: 14

TOYOTA

24.2122-1781.3**011059****Hauptbremszylinder**

Durchmesser [mm]: 22,2

Gewindemaß: M10x1

Anschlussanzahl: 4

MAPP-Code vorhanden:

Ergänzungsartikel/Ergänzende Info 2: ohne Bremsflüssigkeitsbehälter

Länge 1 [mm]: 29,5

Länge 2 [mm]: 122,5

FIAT**24.2122-1785.3****011114****Hauptbremszylinder**

Durchmesser [mm]: 22,2

Gewindemaß: M12x1

Anschlussanzahl: 2

MAPP-Code vorhanden:

Ergänzungsartikel/Ergänzende Info 2: ohne Bremsflüssigkeitsbehälter

Länge 1 [mm]: 27,9

Länge 2 [mm]: 96

TOYOTA**24.2122-1786.3****011115****Hauptbremszylinder**

Durchmesser [mm]: 22,2

Gewindemaß: M10x1

Anschlussanzahl: 2

MAPP-Code vorhanden:

Ergänzungsartikel/Ergänzende Info 2: ohne Bremsflüssigkeitsbehälter

Länge 1 [mm]: 27,9

Länge 2 [mm]: 96

TOYOTA**24.2122-1981.3****011024****Hauptbremszylinder**

Durchmesser [mm]: 22,2

Gewindemaß: M12x1

Anschlussanzahl: 2

MAPP-Code vorhanden:

Bremsssystem: ATE

Ergänzungsartikel/Ergänzende Info 2: ohne Bremsflüssigkeitsbehälter

Länge 1 [mm]: 113

Länge 2 [mm]: 66

AUDI, SEAT, SKODA, VW

24.2122-2171.3**011122****Hauptbremszylinder**

Durchmesser [mm]: 22,2

Gewindemaß: M12x1

Anschlussanzahl: 2

MAPP-Code vorhanden:

Bremsystem: ATE

Länge 1 [mm]: 43,2

Länge 2 [mm]: 125,8

PEUGEOT**24.2123-1602.3****010384****Hauptbremszylinder**

Durchmesser [mm]: 23,8

Gewindemaß: M10x1

Anschlussanzahl: 2

MAPP-Code vorhanden:

Bremsystem: TRW

Länge 1 [mm]: 32

Länge 2 [mm]: 126,5

AUDI**24.2123-1701.3****010424****Hauptbremszylinder**

Durchmesser [mm]: 23,8

Gewindemaß: M10x1

Anschlussanzahl: 4

MAPP-Code vorhanden:

Länge 1 [mm]: 36,5

Länge 2 [mm]: 126,7

RENAULT**24.2123-1707.3****010492****Hauptbremszylinder**

Durchmesser [mm]: 23,8

Gewindemaß: M10x1

Anschlussanzahl: 4

MAPP-Code vorhanden:

Länge 1 [mm]: 36

Länge 2 [mm]: 117,5

CITROËN, FIAT, PEUGEOT

24.2123-1709.3**010503****Hauptbremszylinder**

Durchmesser [mm]: 23,8

Gewindemaß: M12x1

Anschlussanzahl: 2

MAPP-Code vorhanden:

Länge 1 [mm]: 32

Länge 2 [mm]: 122

AUDI, SEAT, SKODA, VW**24.2123-1710.3****010504****Hauptbremszylinder**

Durchmesser [mm]: 23,8

Gewindemaß: M10x1

Anschlussanzahl: 4

MAPP-Code vorhanden:

Länge 1 [mm]: 36

Länge 2 [mm]: 118

CITROËN, PEUGEOT**24.2123-1711.3****010518****Hauptbremszylinder**

Durchmesser [mm]: 23,8

Gewindemaß: M10x1

Anschlussanzahl: 2

MAPP-Code vorhanden:

Länge 1 [mm]: 35

Länge 2 [mm]: 165

MERCEDES-BENZ, VW**24.2123-1712.3****010519****Hauptbremszylinder**

Durchmesser [mm]: 23,8

Gewindemaß: M10x1

Anschlussanzahl: 4

MAPP-Code vorhanden:

Länge 1 [mm]: 36

Länge 2 [mm]: 120

MERCEDES-BENZ

24.2123-1713.3**010505****Hauptbremszylinder**

Durchmesser [mm]: 23,8

Gewindemaß: M12x1

Anschlussanzahl: 2

MAPP-Code vorhanden:

Länge 1 [mm]: 34,5

Länge 2 [mm]: 127

CITROËN, PEUGEOT**24.2123-1714.3****010587****Hauptbremszylinder**

Durchmesser [mm]: 23,8

Anschlussanzahl: 4

MAPP-Code vorhanden:

Bremsystem: BDX

Gewindemaß 1: 2x M10x1

Gewindemaß 2: 2x M12x1

Länge 1 [mm]: 33

Länge 2 [mm]: 120,5

CITROËN, PEUGEOT**24.2123-1715.3****010520****Hauptbremszylinder**

Durchmesser [mm]: 23,8

Anschlussanzahl: 2

MAPP-Code vorhanden:

Bremsystem: BDX

Gewindemaß 1: 1x M10x1

Gewindemaß 2: 1x M12x1

Länge 1 [mm]: 33

Länge 2 [mm]: 120,5

CITROËN, PEUGEOT**24.2123-1717.3****010521****Hauptbremszylinder**

Durchmesser [mm]: 23,8

Gewindemaß: M12x1

Anschlussanzahl: 2

MAPP-Code vorhanden:

Länge 1 [mm]: 39,5

Länge 2 [mm]: 121,5

AUDI, PORSCHE, VW

24.2123-1724.3**010566****Hauptbremszylinder**

Durchmesser [mm]: 23,8

Anschlussanzahl: 3

MAPP-Code vorhanden:

Bremsystem: BDX

Gewindemaß 1: 2x M10x1

Gewindemaß 2: 1x M12x1

Länge 1 [mm]: 10

Länge 2 [mm]: 203

FORD**24.2123-1725.3****010549****Hauptbremszylinder**

Durchmesser [mm]: 23,8

Anschlussanzahl: 4

MAPP-Code vorhanden:

Gewindemaß 1: 2x M10x1

Gewindemaß 2: 2x M12x1

Länge 1 [mm]: 36,5

Länge 2 [mm]: 126,5

RENAULT**24.2123-1728.3****010558****Hauptbremszylinder**

Durchmesser [mm]: 23,8

Gewindemaß: M10x1

Anschlussanzahl: 2

MAPP-Code vorhanden:

Länge 1 [mm]: 36

Länge 2 [mm]: 128

VW**24.2123-1729.3****010567****Hauptbremszylinder**

Durchmesser [mm]: 23,8

Gewindemaß: M10x1

Anschlussanzahl: 2

MAPP-Code vorhanden:

Länge 1 [mm]: 35

Länge 2 [mm]: 150,8

MERCEDES-BENZ

24.2123-1730.3**010620****Hauptbremszylinder**

Durchmesser [mm]: 23,8

Anschlussanzahl: 2

MAPP-Code vorhanden:

Gewindemaß 1: 1x M10x1

Gewindemaß 2: 1x M12x1

Länge 1 [mm]: 39,5

Länge 2 [mm]: 120,5

AUDI, PORSCHE, VW**24.2123-1732.3****010625****Hauptbremszylinder**

Durchmesser [mm]: 23,8

Gewindemaß: M10x1

Anschlussanzahl: 4

MAPP-Code vorhanden:

Ergänzungsartikel/Ergänzende Info 2: ohne Bremsflüssigkeitsbehälter

Länge 1 [mm]: 36

Länge 2 [mm]: 105,5

FORD**24.2123-1733.3****010657****Hauptbremszylinder**

Durchmesser [mm]: 23,8

Gewindemaß: M10x1

Anschlussanzahl: 2

MAPP-Code vorhanden:

Bremsssystem: BOS

Länge 1 [mm]: 36,5

Länge 2 [mm]: 126,7

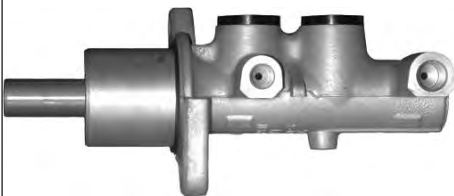
CITROËN, FIAT, LANCIA, PEUGEOT**24.2123-1734.3****010640****Hauptbremszylinder**

Durchmesser [mm]: 23,8

Anschlussanzahl: 2

MAPP-Code vorhanden:

Bremsssystem: TRW

Gewindemaß 1: 1x M10x1

Gewindemaß 2: 1x M12x1

Länge 1 [mm]: 39,5

Länge 2 [mm]: 119,5

CHEVROLET, OPEL, VAUXHALL

24.2123-1737.3**010654****Hauptbremszylinder**

Durchmesser [mm]: 23,8

Gewindemaß: M10x1

Anschlussanzahl: 4

MAPP-Code vorhanden:

Länge 1 [mm]: 17

Länge 2 [mm]: 174

FORD**24.2123-1738.3****010658****Hauptbremszylinder**

Durchmesser [mm]: 23,8

Gewindemaß: M10x1

Anschlussanzahl: 4

MAPP-Code vorhanden:

Länge 1 [mm]: 36

Länge 2 [mm]: 118,5

CITROËN, FIAT, PEUGEOT**24.2123-1739.3****010661****Hauptbremszylinder**

Durchmesser [mm]: 23,8

Gewindemaß: M12x1

Anschlussanzahl: 2

MAPP-Code vorhanden:

Länge 1 [mm]: 39,5

Länge 2 [mm]: 121

CHEVROLET, OPEL, VAUXHALL**24.2123-1741.3****010681****Hauptbremszylinder**

Durchmesser [mm]: 23,8

Gewindemaß: M12x1

Anschlussanzahl: 2

MAPP-Code vorhanden:

Länge 1 [mm]: 33

Länge 2 [mm]: 127

PEUGEOT

24.2123-1742.3**010671****Hauptbremszylinder**

Durchmesser [mm]: 23,8

Gewindemaß: M12x1

Anschlussanzahl: 2

MAPP-Code vorhanden:

Länge 1 [mm]: 33

Länge 2 [mm]: 121

FORD**24.2123-1746.3****010682****Hauptbremszylinder**

Durchmesser [mm]: 23,8

Gewindemaß: M10x1

Anschlussanzahl: 2

MAPP-Code vorhanden:

Länge 1 [mm]: 36,5

Länge 2 [mm]: 116,5

VOLVO**24.2123-1749.3****010713****Hauptbremszylinder**

Durchmesser [mm]: 23,8

Gewindemaß: M10x1

Anschlussanzahl: 2

MAPP-Code vorhanden:

Länge 1 [mm]: 33

Länge 2 [mm]: 120

FORD**24.2123-1751.3****010698****Hauptbremszylinder**

Durchmesser [mm]: 23,8

Gewindemaß: M10x1

Anschlussanzahl: 4

MAPP-Code vorhanden:

Länge 1 [mm]: 36

Länge 2 [mm]: 118

PEUGEOT

24.2123-1754.3**010741****Hauptbremszylinder**

Durchmesser [mm]: 23,8

Gewindemaß: M12x1

Anschlussanzahl: 2

MAPP-Code vorhanden:

Länge 1 [mm]: 67

Länge 2 [mm]: 111,5

MERCEDES-BENZ**24.2123-1755.3****010750****Hauptbremszylinder**

Durchmesser [mm]: 23,8

Gewindemaß: M10x1

Anschlussanzahl: 2

MAPP-Code vorhanden:

Länge 1 [mm]: 67

Länge 2 [mm]: 110

VW**24.2123-1759.3****010768****Hauptbremszylinder**

Durchmesser [mm]: 23,8

Gewindemaß: M12x1

Anschlussanzahl: 2

MAPP-Code vorhanden:

Bremsssystem: BOS

Länge 1 [mm]: 39

Länge 2 [mm]: 143,2

NISSAN, OPEL, RENAULT, VAUXHALL**24.2123-1760.3****010779****Hauptbremszylinder**

Durchmesser [mm]: 23,8

Gewindemaß: M12x1

Anschlussanzahl: 2

MAPP-Code vorhanden:

Bremsssystem: TRW

Länge 1 [mm]: 25

Länge 2 [mm]: 155

RENAULT

24.2123-1762.3**010823****Hauptbremszylinder**

Durchmesser [mm]: 23,8

Gewindemaß: M10x1

Anschlussanzahl: 2

MAPP-Code vorhanden:

Länge 1 [mm]: 15

Länge 2 [mm]: 161

HYUNDAI**24.2123-1763.3****010842****Hauptbremszylinder**

Durchmesser [mm]: 23,8

Gewindemaß: M10x1

Anschlussanzahl: 2

MAPP-Code vorhanden:

Länge 1 [mm]: 32,5

Länge 2 [mm]: 131

FIAT, LANCIA**24.2123-1764.3****010824****Hauptbremszylinder**

Durchmesser [mm]: 23,8

Anschlussanzahl: 2

MAPP-Code vorhanden:

Bremsystem: TRW

Gewindemaß 1: 1x M10x1

Gewindemaß 2: 1x M12x1

Länge 1 [mm]: 29

Länge 2 [mm]: 132

OPEL, VAUXHALL**24.2123-1766.3****010825****Hauptbremszylinder**

Durchmesser [mm]: 23,8

Gewindemaß: M12x1

Anschlussanzahl: 2

MAPP-Code vorhanden:

Bremsystem: TRW

Länge 1 [mm]: 40

Länge 2 [mm]: 121

PORSCHE

24.2123-1767.3**010844****Hauptbremszylinder**

Durchmesser [mm]: 23,8

Gewindemaß: M10x1

Anschlussanzahl: 2

MAPP-Code vorhanden:

Bremsystem: BOS

Länge 1 [mm]: 31

Länge 2 [mm]: 131

OPEL, VAUXHALL**24.2123-1771.3****010857****Hauptbremszylinder**

Durchmesser [mm]: 23,8

Gewindemaß: M14x1,5

Anschlussanzahl: 2

MAPP-Code vorhanden:

Bremsystem: BOS

Ergänzungsartikel/Ergänzende Info 2: ohne Bremsflüssigkeitsbehälter

Länge 1 [mm]: 37

Länge 2 [mm]: 131

TOYOTA**24.2123-1772.3****010858****Hauptbremszylinder**

Durchmesser [mm]: 23,8

Gewindemaß: M12x1

Anschlussanzahl: 2

MAPP-Code vorhanden:

Bremsystem: BOS

Länge 1 [mm]: 73

Länge 2 [mm]: 122

MERCEDES-BENZ**24.2123-1776.3****010926****Hauptbremszylinder**

Durchmesser [mm]: 23,8

Gewindemaß: M12x1

Anschlussanzahl: 2

MAPP-Code vorhanden:

Bremsystem: TRW

Länge 1 [mm]: 40

Länge 2 [mm]: 115

MERCEDES-BENZ

24.2123-1777.3**010943****Hauptbremszylinder**

Durchmesser [mm]: 23,8

Anschlussanzahl: 2

MAPP-Code vorhanden:

Gewindemaß 1: 1x M10x1

Gewindemaß 2: 1x M12x1

Länge 1 [mm]: 39,5

Länge 2 [mm]: 120,5

OPEL, VAUXHALL**24.2123-1778.3****010947****Hauptbremszylinder**

Durchmesser [mm]: 23,8

Gewindemaß: M12x1

Anschlussanzahl: 2

MAPP-Code vorhanden:

Bremsystem: TRW

Länge 1 [mm]: 72

Länge 2 [mm]: 122

MERCEDES-BENZ**24.2123-1779.3****011078****Hauptbremszylinder**

Durchmesser [mm]: 23,8

Gewindemaß: M12x1

Anschlussanzahl: 2

Material: Aluguss

MAPP-Code vorhanden:

Ergänzungsartikel/Ergänzende Info 2: ohne Bremsflüssigkeitsbehälter

Länge 1 [mm]: 36

Länge 2 [mm]: 135

FORD**24.2123-1780.3****011081****Hauptbremszylinder**

Durchmesser [mm]: 23,8

Gewindemaß: M12x1

Anschlussanzahl: 2

Material: Aluguss

MAPP-Code vorhanden:

Ergänzungsartikel/Ergänzende Info 2: ohne Bremsflüssigkeitsbehälter

Länge 1 [mm]: 41

Länge 2 [mm]: 104

SMART

24.2123-1781.3**011060****Hauptbremszylinder**

Durchmesser [mm]: 23,8

Gewindemaß: 7/16 -24 UNS

Anschlussanzahl: 2

MAPP-Code vorhanden:

Ergänzungsartikel/Ergänzende Info 2: ohne Bremsflüssigkeitsbehälter

Länge 1 [mm]: 73

Länge 2 [mm]: 152,6

CHRYSLER**24.2123-3041.3****011021****Hauptbremszylinder**

Durchmesser [mm]: 23,8

Gewindemaß: M10x1

Anschlussanzahl: 4

MAPP-Code vorhanden:

Bremsystem: ATE

Ergänzungsartikel/Ergänzende Info 2: ohne Bremsflüssigkeitsbehälter / ohne Druckregler

Länge 1 [mm]: 41,5

Länge 2 [mm]: 101,7

FORD**24.2123-3396.3****011035****Hauptbremszylinder**

Durchmesser [mm]: 23,8

Gewindemaß: M10x1

Anschlussanzahl: 2

MAPP-Code vorhanden:

Bremsystem: ATE

Ergänzungsartikel/Ergänzende Info 2: ohne Bremsflüssigkeitsbehälter

Länge 1 [mm]: 33,2

Länge 2 [mm]: 137,3

CITROËN, PEUGEOT**24.2125-1702.3****010482****Hauptbremszylinder**

Durchmesser [mm]: 25,4

Gewindemaß: M10x1

Anschlussanzahl: 2

MAPP-Code vorhanden:

Länge 1 [mm]: 19

Länge 2 [mm]: 173,5

CITROËN, FIAT, PEUGEOT

24.2125-1703.3**010483****Hauptbremszylinder**

Durchmesser [mm]: 25,4

Gewindemaß: M10x1

Anschlussanzahl: 5

MAPP-Code vorhanden:

Länge 1 [mm]: 9

Länge 2 [mm]: 168

CITROËN, FIAT, OPEL, PEUGEOT, VAUXHALL**24.2125-1704.3****010446****Hauptbremszylinder**

Durchmesser [mm]: 25,4

Anschlussanzahl: 2

MAPP-Code vorhanden:

Bremsystem: TRW

Gewindemaß 1: 1x M10x1

Gewindemaß 2: 1x M12x1

Länge 1 [mm]: 15,5

Länge 2 [mm]: 189

OPEL, VAUXHALL**24.2125-1709.3****010499****Hauptbremszylinder**

Durchmesser [mm]: 25,4

Gewindemaß: M12x1

Anschlussanzahl: 2

MAPP-Code vorhanden:

Länge 1 [mm]: 38

Länge 2 [mm]: 125

FORD**24.2125-1712.3****010622****Hauptbremszylinder**

Durchmesser [mm]: 25,4

Gewindemaß: M12x1

Anschlussanzahl: 2

MAPP-Code vorhanden:

Länge 1 [mm]: 49,5

Länge 2 [mm]: 111,5

AUDI, VW

24.2125-1713.3**010623****Hauptbremszylinder**

Durchmesser [mm]: 25,4

Anschlussanzahl: 2

MAPP-Code vorhanden:

Gewindemaß 1: 1x M10x1

Gewindemaß 2: 1x M12x1

Länge 1 [mm]: 49

Länge 2 [mm]: 111

AUDI, VW**24.2125-1720.3****010688****Hauptbremszylinder**

Durchmesser [mm]: 25,4

Gewindemaß: M12x1

Anschlussanzahl: 2

MAPP-Code vorhanden:

Bremsystem: TRW

Länge 1 [mm]: 69,5

Länge 2 [mm]: 92

AUDI, SEAT, SKODA, VW**24.2125-1721.3****010673****Hauptbremszylinder**

Durchmesser [mm]: 25,4

Anschlussanzahl: 4

MAPP-Code vorhanden:

Gewindemaß 1: 2x M10x1

Gewindemaß 2: 2x M12x1

Ergänzungsartikel/Ergänzende Info 2: ohne Bremsflüssigkeitsbehälter

Länge 1 [mm]: 43

Länge 2 [mm]: 110,5

FORD**24.2125-1722.3****010674****Hauptbremszylinder**

Durchmesser [mm]: 25,4

Gewindemaß: M12x1

Anschlussanzahl: 2

MAPP-Code vorhanden:

Ergänzungsartikel/Ergänzende Info 2: ohne Bremsflüssigkeitsbehälter

Länge 1 [mm]: 42,5

Länge 2 [mm]: 110,5

FORD

24.2125-1726.3**010718****Hauptbremszylinder**

Durchmesser [mm]: 25,4

Gewindemaß: M10x1

Anschlussanzahl: 2

MAPP-Code vorhanden:

Länge 1 [mm]: 33

Länge 2 [mm]: 147

CITROËN, FIAT, PEUGEOT**24.2125-1727.3****010723****Hauptbremszylinder**

Durchmesser [mm]: 25,4

Gewindemaß: M10x1

Anschlussanzahl: 2

MAPP-Code vorhanden:

Länge 1 [mm]: 35

Länge 2 [mm]: 165,3

MERCEDES-BENZ, VW**24.2125-1728.3****010751****Hauptbremszylinder**

Durchmesser [mm]: 25,4

Gewindemaß: M12x1

Anschlussanzahl: 2

MAPP-Code vorhanden:

Länge 1 [mm]: 67

Länge 2 [mm]: 111,5

MERCEDES-BENZ**24.2125-1729.3****010752****Hauptbremszylinder**

Durchmesser [mm]: 25,4

Gewindemaß: M12x1

Anschlussanzahl: 2

MAPP-Code vorhanden:

Länge 1 [mm]: 47

Länge 2 [mm]: 114

ALFA ROMEO

24.2125-1731.3**010826****Hauptbremszylinder**

Durchmesser [mm]: 25,4

Gewindemaß: M12x1

Anschlussanzahl: 2

MAPP-Code vorhanden:

Bremsystem: TRW

Länge 1 [mm]: 47,5

Länge 2 [mm]: 113

NISSAN, OPEL, RENAULT, VAUXHALL**24.2125-1732.3****010827****Hauptbremszylinder**

Durchmesser [mm]: 25,4

Gewindemaß: M12x1

Anschlussanzahl: 2

MAPP-Code vorhanden:

Bremsystem: TRW

Länge 1 [mm]: 40

Länge 2 [mm]: 122

ALFA ROMEO, CHEVROLET, FIAT, OPEL, SAAB, VAUXHALL**24.2125-1735.3****010879****Hauptbremszylinder**

Durchmesser [mm]: 25,4

Gewindemaß: M10x1

Anschlussanzahl: 2

MAPP-Code vorhanden:

Bremsystem: TRW

Länge 1 [mm]: 67

Länge 2 [mm]: 111,5

VW**24.2125-1736.3****010904****Hauptbremszylinder**

Durchmesser [mm]: 25,4

Gewindemaß: M12x1

Anschlussanzahl: 2

MAPP-Code vorhanden:

Bremsystem: TRW

Länge 1 [mm]: 31

Länge 2 [mm]: 129

OPEL, VAUXHALL

24.2125-1737.3**010906****Hauptbremszylinder**

Durchmesser [mm]: 25,4

Anschlussanzahl: 2

MAPP-Code vorhanden:

Bremsystem: TRW

Gewindemaß 1: M10x1

Gewindemaß 2: M12x1

Länge 1 [mm]: 31

Länge 2 [mm]: 129

OPEL, VAUXHALL**24.2125-1739.3****010948****Hauptbremszylinder**

Durchmesser [mm]: 25,4

Gewindemaß: M12x1

Anschlussanzahl: 2

MAPP-Code vorhanden:

Bremsystem: TRW

Länge 1 [mm]: 69

Länge 2 [mm]: 90

AUDI**24.2125-1740.3****010971****Hauptbremszylinder**

Durchmesser [mm]: 25,4

Gewindemaß: M12x1

Anschlussanzahl: 2

MAPP-Code vorhanden:

Bremsystem: TRW

Länge 1 [mm]: 47

Länge 2 [mm]: 113

OPEL, VAUXHALL**24.2125-1741.3****010988****Hauptbremszylinder**

Durchmesser [mm]: 25,4

Gewindemaß: M10x1

Anschlussanzahl: 2

MAPP-Code vorhanden:

Ergänzungsartikel/Ergänzende Info 2: ohne Bremsflüssigkeitsbehälter

Länge 1 [mm]: 15,7

Länge 2 [mm]: 152,5

NISSAN

24.2125-1742.3**010978****Hauptbremszylinder**

Durchmesser [mm]: 25,4

Gewindemaß: M12x1

Anschlussanzahl: 2

MAPP-Code vorhanden:

Bremsystem: TRW

Länge 1 [mm]: 25,3

Länge 2 [mm]: 157

RENAULT**24.2125-1745.3****010998****Hauptbremszylinder**

Durchmesser [mm]: 25,4

Gewindemaß: M12x1

Anschlussanzahl: 2

MAPP-Code vorhanden:

Bremsystem: TRW

Länge 1 [mm]: 75

Länge 2 [mm]: 134,6

MERCEDES-BENZ**24.2125-1747.3****011029****Hauptbremszylinder**

Durchmesser [mm]: 25,4

Gewindemaß: M10x1

Anschlussanzahl: 2

Material: Aluguss

MAPP-Code vorhanden:

Länge 1 [mm]: 18,5

Länge 2 [mm]: 142,4

FORD, MAZDA**24.2125-1748.3****011030****Hauptbremszylinder**

Durchmesser [mm]: 25,4

Gewindemaß: M12x1

Anschlussanzahl: 2

Material: Aluguss

MAPP-Code vorhanden:

Bremsystem: TRW

Länge 1 [mm]: 70,5

Länge 2 [mm]: 140,5

MERCEDES-BENZ

24.2125-1749.3**011031****Hauptbremszylinder**

Durchmesser [mm]: 25,4

Gewindemaß: M12x1

Anschlussanzahl: 2

Material: Aluguss

MAPP-Code vorhanden:

Bremsystem: TRW

Länge 1 [mm]: 66,5

Länge 2 [mm]: 93

AUDI**24.2125-1750.3****011050****Hauptbremszylinder**

Durchmesser [mm]: 25,4

Gewindemaß: M12x1

Anschlussanzahl: 2

Material: Aluguss

MAPP-Code vorhanden:

Ergänzungsartikel/Ergänzende Info 2: ohne Bremsflüssigkeitsbehälter

Länge 1 [mm]: 73,5

Länge 2 [mm]: 124,5

MERCEDES-BENZ, VW**24.2126-1702.3****010950****Hauptbremszylinder**

Durchmesser [mm]: 27

Gewindemaß: M10x1

Anschlussanzahl: 2

MAPP-Code vorhanden:

Länge 1 [mm]: 19

Länge 2 [mm]: 133

KIA**24.2126-1704.3****010990****Hauptbremszylinder**

Durchmesser [mm]: 27

Gewindemaß: M12x1

Anschlussanzahl: 2

MAPP-Code vorhanden:

Bremsystem: TRW

Länge 1 [mm]: 72

Länge 2 [mm]: 120

MERCEDES-BENZ, VW

24.2126-1705.3**010999****Hauptbremszylinder**

Durchmesser [mm]: 27

Gewindemaß: M12x1

Anschlussanzahl: 2

MAPP-Code vorhanden:

Bremsystem: TRW

Länge 1 [mm]: 90,5

Länge 2 [mm]: 69,3

AUDI**24.2126-1706.3****011062****Hauptbremszylinder**

Durchmesser [mm]: 26

Gewindemaß: 7/16-24 UNS

Anschlussanzahl: 2

Material: Aluguss

MAPP-Code vorhanden:

Ergänzungsartikel/Ergänzende Info 2: ohne Bremsflüssigkeitsbehälter

Länge 1 [mm]: 73

Länge 2 [mm]: 152,6

CHRYSLER**24.2126-1707.3****011061****Hauptbremszylinder**

Durchmesser [mm]: 26

Gewindemaß: M12x1

Anschlussanzahl: 2

Material: Aluguss

MAPP-Code vorhanden:

Ergänzungsartikel/Ergänzende Info 2: ohne Bremsflüssigkeitsbehälter

Länge 1 [mm]: 73

Länge 2 [mm]: 152,6

CHRYSLER**24.2126-1708.3****011128****Hauptbremszylinder**

Durchmesser [mm]: 27

Gewindemaß: M12x1

Anschlussanzahl: 2

Material: Aluguss

MAPP-Code vorhanden:

Ergänzungsartikel/Ergänzende Info 2: ohne Bremsflüssigkeitsbehälter

Länge 1 [mm]: 51

Länge 2 [mm]: 141,2

MERCEDES-BENZ, VW

24.2126-3032.3**011036****Hauptbremszylinder**

Durchmesser [mm]: 27

Gewindemaß: M12x1

Anschlussanzahl: 2

MAPP-Code vorhanden:

Bremsystem: ATE

Ergänzungsartikel/Ergänzende Info 2: ohne Bremsflüssigkeitsbehälter

Länge 1 [mm]: 18,7

Länge 2 [mm]: 133,5

PORSCHE, VW**24.2126-3071.3****011037****Hauptbremszylinder**

Durchmesser [mm]: 27

Gewindemaß: M12x1

Anschlussanzahl: 2

MAPP-Code vorhanden:

Bremsystem: ATE

Ergänzungsartikel/Ergänzende Info 2: ohne Bremsflüssigkeitsbehälter

Länge 1 [mm]: 23,3

Länge 2 [mm]: 128,9

AUDI**24.2126-3131.3****011038****Hauptbremszylinder**

Durchmesser [mm]: 27

Gewindemaß: M12x1

Anschlussanzahl: 2

MAPP-Code vorhanden:

Bremsystem: ATE

Ergänzungsartikel/Ergänzende Info 2: ohne Bremsflüssigkeitsbehälter

Länge 1 [mm]: 37,2

Länge 2 [mm]: 139,8

VW**24.4025-1701.3****010719****Hauptbremszylinder**

Durchmesser [mm]: 25,4

Gewindemaß: M12x1

Anschlussanzahl: 2

MAPP-Code vorhanden:

Länge 1 [mm]: 51

Länge 2 [mm]: 67,2

MERCEDES-BENZ

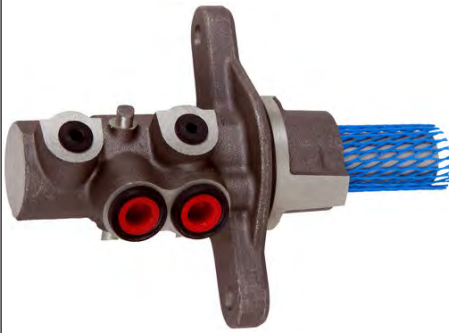
24.4120-1701.3**010846****Hauptbremszylinder**

Durchmesser [mm]: 20,6

Gewindemaß: M10x1

Anschlussanzahl: 2

MAPP-Code vorhanden:

Bremsssystem: BOS

Länge 1 [mm]: 32

Länge 2 [mm]: 86,3

CITROËN, PEUGEOT, TOYOTA**24.4120-1702.3****010913****Hauptbremszylinder**

Durchmesser [mm]: 20,6

Gewindemaß: M10x1

Anschlussanzahl: 2

MAPP-Code vorhanden:

Bremsssystem: TRW

Ergänzungsartikel/Ergänzende Info 2: ohne Bremsflüssigkeitsbehälter

Länge 1 [mm]: 6

Länge 2 [mm]: 119

FIAT**24.4120-1703.3****011015****Hauptbremszylinder**

Durchmesser [mm]: 20,6

Gewindemaß: M12x1

Anschlussanzahl: 2

MAPP-Code vorhanden:

Bremsssystem: TRW

Ergänzungsartikel/Ergänzende Info 2: ohne Bremsflüssigkeitsbehälter

Länge 1 [mm]: 11,3

Länge 2 [mm]: 107

SEAT, SKODA, VW**24.4120-1704.3****011042****Hauptbremszylinder**

Durchmesser [mm]: 20,6

Gewindemaß: M12x1

Anschlussanzahl: 2

Material: Aluguss

MAPP-Code vorhanden:

Ergänzungsartikel/Ergänzende Info 2: ohne Bremsflüssigkeitsbehälter

Länge 1 [mm]: 32

Länge 2 [mm]: 85

CITROËN, PEUGEOT, TOYOTA

24.4120-1705.3**011051****Hauptbremszylinder**

Durchmesser [mm]: 20,6

Gewindemaß: M12x1

Anschlussanzahl: 2

Material: Aluguss

MAPP-Code vorhanden:

Ergänzungsartikel/Ergänzende Info 2: ohne Bremsflüssigkeitsbehälter

Länge 1 [mm]: 32

Länge 2 [mm]: 86

CITROËN, PEUGEOT, TOYOTA**24.4120-1706.3****011072****Hauptbremszylinder**

Durchmesser [mm]: 20,6

Gewindemaß: M10x1

Anschlussanzahl: 2

Material: Aluguss

MAPP-Code vorhanden:

Ergänzungsartikel/Ergänzende Info 2: ohne Bremsflüssigkeitsbehälter

Länge 1 [mm]: 5,5

Länge 2 [mm]: 110,5

FORD**24.4120-1708.3****011084****Hauptbremszylinder**

Durchmesser [mm]: 20,6

Gewindemaß: M12x1

Anschlussanzahl: 2

Material: Aluguss

MAPP-Code vorhanden:

Ergänzungsartikel/Ergänzende Info 2: ohne Bremsflüssigkeitsbehälter

Länge 1 [mm]: 32

Länge 2 [mm]: 85,4

TOYOTA**24.4120-1710.3****011082****Hauptbremszylinder**

Durchmesser [mm]: 20,6

Gewindemaß: M12x1

Anschlussanzahl: 2

Material: Aluguss

MAPP-Code vorhanden:

Ergänzungsartikel/Ergänzende Info 2: ohne Bremsflüssigkeitsbehälter

Länge 1 [mm]: 32

Länge 2 [mm]: 87,4

FORD

24.4120-1711.3**011093****Hauptbremszylinder**

Durchmesser [mm]: 20,6

Gewindemaß: M10x1

Anschlussanzahl: 2

Material: Aluguss

MAPP-Code vorhanden:

Ergänzungsartikel/Ergänzende Info 2: ohne Bremsflüssigkeitsbehälter

Länge 1 [mm]: 32

Länge 2 [mm]: 87,4

FORD**24.4120-1712.3****011092****Hauptbremszylinder**

Durchmesser [mm]: 20,6

Gewindemaß: M10x1

Anschlussanzahl: 2

Material: Aluguss

MAPP-Code vorhanden:

Ergänzungsartikel/Ergänzende Info 2: ohne Bremsflüssigkeitsbehälter

Länge 1 [mm]: 32

Länge 2 [mm]: 85,4

CITROËN, PEUGEOT, TOYOTA**24.4120-1713.3****011102****Hauptbremszylinder**

Durchmesser [mm]: 20,6

Gewindemaß: M12x1

Anschlussanzahl: 2

Material: Aluguss

MAPP-Code vorhanden:

Ergänzungsartikel/Ergänzende Info 2: ohne Bremsflüssigkeitsbehälter

Länge 1 [mm]: 12

Länge 2 [mm]: 96,9

HYUNDAI**24.4120-1771.3****011076****Hauptbremszylinder**

Durchmesser [mm]: 20,6

Gewindemaß: M12x1

Anschlussanzahl: 2

Material: Aluguss

MAPP-Code vorhanden:

Ergänzungsartikel/Ergänzende Info 2: ohne Bremsflüssigkeitsbehälter

Länge 1 [mm]: 1

Länge 2 [mm]: 111

DACIA, RENAULT

24.4122-1701.3**010533****Hauptbremszylinder**

Durchmesser [mm]: 22,2

Gewindemaß: M12x1

Anschlussanzahl: 2

MAPP-Code vorhanden:

Bremsystem: TRW

Länge 1 [mm]: 10,2

Länge 2 [mm]: 109

MERCEDES-BENZ**24.4122-1703.3****010843****Hauptbremszylinder**

Durchmesser [mm]: 22,2

Gewindemaß: M12x1

Anschlussanzahl: 2

MAPP-Code vorhanden:

Bremsystem: TRW

Länge 1 [mm]: 32

Länge 2 [mm]: 112

CITROËN, PEUGEOT**24.4122-1704.3****010847****Hauptbremszylinder**

Durchmesser [mm]: 22,2

Gewindemaß: M10x1

Anschlussanzahl: 2

MAPP-Code vorhanden:

Bremsystem: TRW

Länge 1 [mm]: 6

Länge 2 [mm]: 112

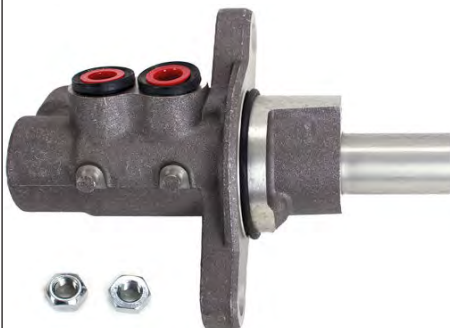
CITROËN, PEUGEOT**24.4122-1705.3****010852****Hauptbremszylinder**

Durchmesser [mm]: 22,2

Gewindemaß: M12x1

Anschlussanzahl: 2

MAPP-Code vorhanden:

Bremsystem: BOS

Ergänzungsartikel/Ergänzende Info 2: ohne Bremsflüssigkeitsbehälter

Länge 1 [mm]: 32

Länge 2 [mm]: 80

OPEL, VAUXHALL

24.4122-1708.3**010865****Hauptbremszylinder**

Durchmesser [mm]: 22,2

Gewindemaß: M10x1

Anschlussanzahl: 2

MAPP-Code vorhanden:

Bremsystem: BOS

Ergänzungsartikel/Ergänzende Info 2: ohne Bremsflüssigkeitsbehälter

Länge 1 [mm]: 20

Länge 2 [mm]: 95

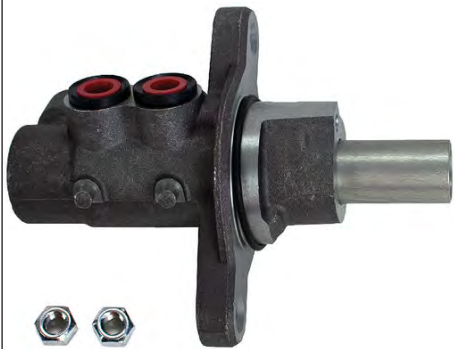
CITROËN**24.4122-1709.3****010871****Hauptbremszylinder**

Durchmesser [mm]: 22,2

Gewindemaß: M10x1

Anschlussanzahl: 2

MAPP-Code vorhanden:

Bremsystem: BOS

Ergänzungsartikel/Ergänzende Info 2: ohne Bremsflüssigkeitsbehälter

Länge 1 [mm]: 32

Länge 2 [mm]: 78

ALFA ROMEO, FIAT, OPEL, VAUXHALL**24.4122-1712.3****010899****Hauptbremszylinder**

Durchmesser [mm]: 22,2

Gewindemaß: M10x1

Anschlussanzahl: 2

MAPP-Code vorhanden:

Ergänzungsartikel/Ergänzende Info 2: ohne Bremsflüssigkeitsbehälter

Bremsystem: BOS

FIAT, SUZUKI**24.4122-1713.3****010900****Hauptbremszylinder**

Durchmesser [mm]: 22,2

Gewindemaß: M12x1

Anschlussanzahl: 2

MAPP-Code vorhanden:

Ergänzungsartikel/Ergänzende Info 2: ohne Bremsflüssigkeitsbehälter

Bremsystem: BOS

FIAT, SUZUKI

24.4122-1714.3**010914****Hauptbremszylinder**

Durchmesser [mm]: 22,2

Gewindemaß: M10x1

Anschlussanzahl: 2

MAPP-Code vorhanden:

Bremsystem: TRW

Ergänzungsartikel/Ergänzende Info 2: ohne Bremsflüssigkeitsbehälter

Länge 1 [mm]: 6

Länge 2 [mm]: 119

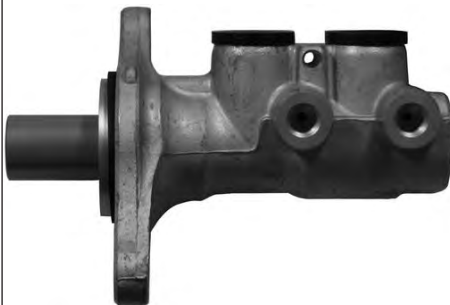
ABARTH, FIAT**24.4122-1717.3****010993****Hauptbremszylinder**

Durchmesser [mm]: 22,2

Gewindemaß: M12x1

Anschlussanzahl: 2

MAPP-Code vorhanden:

Bremsystem: TRW

Ergänzungsartikel/Ergänzende Info 2: ohne Bremsflüssigkeitsbehälter

Länge 1 [mm]: 10,8

Länge 2 [mm]: 109

MITSUBISHI**24.4122-1718.3****011019****Hauptbremszylinder**

Durchmesser [mm]: 22,2

Gewindemaß: M10x1

Anschlussanzahl: 2

MAPP-Code vorhanden:

Bremsystem: BOS

Ergänzungsartikel/Ergänzende Info 2: ohne Bremsflüssigkeitsbehälter

Länge 1 [mm]: 20

Länge 2 [mm]: 91,8

OPEL, SUZUKI, VAUXHALL**24.4122-1719.3****011020****Hauptbremszylinder**

Durchmesser [mm]: 22,2

Gewindemaß: M12x1

Anschlussanzahl: 2

MAPP-Code vorhanden:

Ergänzungsartikel/Ergänzende Info 2: ohne Bremsflüssigkeitsbehälter

Länge 1 [mm]: 20

Länge 2 [mm]: 91,8

OPEL, SUZUKI, VAUXHALL

24.4122-1720.3**011065****Hauptbremszylinder**

Durchmesser [mm]: 22,2

Gewindemaß: M12x1

Anschlussanzahl: 2

Material: Aluguss

MAPP-Code vorhanden:

Bremsystem: ATE

Ergänzungsartikel/Ergänzende Info 2: ohne Bremsflüssigkeitsbehälter

Länge 1 [mm]: 20

Länge 2 [mm]: 91,8

RENAULT**24.4122-1721.3****011079****Hauptbremszylinder**

Durchmesser [mm]: 22,2

Gewindemaß: M10x1

Anschlussanzahl: 2

Material: Aluguss

MAPP-Code vorhanden:

Bremsystem: ATE

Ergänzungsartikel/Ergänzende Info 2: ohne Bremsflüssigkeitsbehälter

Länge 1 [mm]: 21

Länge 2 [mm]: 86,8

FIAT**24.4122-1722.3****011085****Hauptbremszylinder**

Durchmesser [mm]: 22,2

Gewindemaß: M12x1

Anschlussanzahl: 2

Material: Aluguss

MAPP-Code vorhanden:

Ergänzungsartikel/Ergänzende Info 2: ohne Bremsflüssigkeitsbehälter

Länge 1 [mm]: 27

Länge 2 [mm]: 92

BMW, MINI**24.4122-1723.3****011086****Hauptbremszylinder**

Durchmesser [mm]: 22,2

Gewindemaß: M12x1

Anschlussanzahl: 2

Material: Aluguss

MAPP-Code vorhanden:

Ergänzungsartikel/Ergänzende Info 2: ohne Bremsflüssigkeitsbehälter

Länge 1 [mm]: 29

Länge 2 [mm]: 102

HYUNDAI, KIA

24.4122-1724.3**011080****Hauptbremszylinder**

Durchmesser [mm]: 22,2

Gewindemaß: M10x1

Anschlussanzahl: 2

Material: Aluguss

MAPP-Code vorhanden:

Bremsssystem: ATE

Ergänzungsartikel/Ergänzende Info 2: ohne Bremsflüssigkeitsbehälter

Länge 1 [mm]: 29

Länge 2 [mm]: 102

HYUNDAI, KIA**24.4122-1725.3****011087****Hauptbremszylinder**

Durchmesser [mm]: 22,2

Gewindemaß: M12x1

Anschlussanzahl: 2

Material: Aluguss

MAPP-Code vorhanden:

Ergänzungsartikel/Ergänzende Info 2: ohne Bremsflüssigkeitsbehälter

Länge 1 [mm]: 29

Länge 2 [mm]: 102

HYUNDAI**24.4122-1732.3****011107****Hauptbremszylinder**

Durchmesser [mm]: 22,2

Gewindemaß: M12x1

Anschlussanzahl: 2

Material: Aluguss

MAPP-Code vorhanden:

Ergänzungsartikel/Ergänzende Info 2: ohne Bremsflüssigkeitsbehälter

Länge 1 [mm]: 29

Länge 2 [mm]: 102

HYUNDAI, KIA**24.4122-1733.3****011116****Hauptbremszylinder**

Durchmesser [mm]: 22,2

Gewindemaß: M12x1

Anschlussanzahl: 2

Material: Aluguss

MAPP-Code vorhanden:

Ergänzungsartikel/Ergänzende Info 2: ohne Bremsflüssigkeitsbehälter

Länge 1 [mm]: 32

Länge 2 [mm]: 87,4

FORD

24.4122-1734.3**011117****Hauptbremszylinder**

Durchmesser [mm]: 22,2

Gewindemaß: M10x1

Anschlussanzahl: 2

Material: Aluguss

MAPP-Code vorhanden:

Ergänzungsartikel/Ergänzende Info 2: ohne Bremsflüssigkeitsbehälter

Länge 1 [mm]: 32

Länge 2 [mm]: 87,4

FIAT**24.4122-1735.3****011113****Hauptbremszylinder**

Durchmesser [mm]: 22,2

Gewindemaß: M12x1

Anschlussanzahl: 2

Material: Aluguss

MAPP-Code vorhanden:

Ergänzungsartikel/Ergänzende Info 2: ohne Bremsflüssigkeitsbehälter

Länge 1 [mm]: 22

Länge 2 [mm]: 86,6

CHEVROLET**24.4122-1736.3****011129****Hauptbremszylinder**

Durchmesser [mm]: 22,2

Gewindemaß: M10x1

Anschlussanzahl: 2

Material: Aluguss

MAPP-Code vorhanden:

Ergänzungsartikel/Ergänzende Info 2: ohne Bremsflüssigkeitsbehälter

Länge 1 [mm]: 29

Länge 2 [mm]: 101,9

HYUNDAI**24.4123-1703.3****010831****Hauptbremszylinder**

Durchmesser [mm]: 23,8

Gewindemaß: M12x1

Anschlussanzahl: 2

MAPP-Code vorhanden:

Bremsystem: TRW

Länge 1 [mm]: 55

Länge 2 [mm]: 53

MERCEDES-BENZ

24.4123-1704.3**010828****Hauptbremszylinder**

Durchmesser [mm]: 23,8

Gewindemaß: M12x1

Anschlussanzahl: 2

MAPP-Code vorhanden:

Bremsystem: TRW

Länge 1 [mm]: 6

Länge 2 [mm]: 112

CITROËN, OPEL, PEUGEOT, VAUXHALL**24.4123-1705.3****010832****Hauptbremszylinder**

Durchmesser [mm]: 23,8

Gewindemaß: M10x1

Anschlussanzahl: 2

MAPP-Code vorhanden:

Bremsystem: TRW

Länge 1 [mm]: 6

Länge 2 [mm]: 112

CITROËN, PEUGEOT**24.4123-1708.3****010859****Hauptbremszylinder**

Durchmesser [mm]: 23,8

Gewindemaß: M10x1

Anschlussanzahl: 2

MAPP-Code vorhanden:

Bremsystem: BOS

Länge 1 [mm]: 32

Länge 2 [mm]: 83,5

FIAT, LANCIA**24.4123-1710.3****010866****Hauptbremszylinder**

Durchmesser [mm]: 23,8

Gewindemaß: M10x1

Anschlussanzahl: 2

MAPP-Code vorhanden:

Bremsystem: BOS

Ergänzungsartikel/Ergänzende Info 2: ohne Bremsflüssigkeitsbehälter

Länge 1 [mm]: 32

Länge 2 [mm]: 86,2

CHRYSLER, FIAT, LANCIA

24.4123-1712.3**010897****Hauptbremszylinder**

Durchmesser [mm]: 23,8

Gewindemaß: M12x1

Anschlussanzahl: 2

MAPP-Code vorhanden:

Bremsystem: TRW

Länge 1 [mm]: 14

Länge 2 [mm]: 95

MINI**24.4123-1713.3****010905****Hauptbremszylinder**

Durchmesser [mm]: 23,8

Anschlussanzahl: 4

MAPP-Code vorhanden:

Bremsystem: BOS

Gewindemaß 1: 2x M10x1

Gewindemaß 2: 2x M12x1

Ergänzungsartikel/Ergänzende Info 2: ohne Bremsflüssigkeitsbehälter

Länge 1 [mm]: 31,7

Länge 2 [mm]: 93,5

FORD**24.4123-1714.3****010979****Hauptbremszylinder**

Durchmesser [mm]: 23,8

Gewindemaß: M12x1

Anschlussanzahl: 2

MAPP-Code vorhanden:

Bremsystem: TRW

Länge 1 [mm]: 18

Länge 2 [mm]: 100

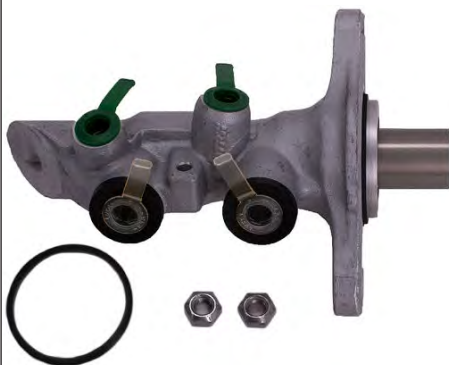
CITROËN, PEUGEOT**24.4123-1715.3****010980****Hauptbremszylinder**

Durchmesser [mm]: 23,8

Gewindemaß: M12x1

Anschlussanzahl: 2

MAPP-Code vorhanden:

Bremsystem: TRW

Länge 1 [mm]: 5,7

Länge 2 [mm]: 147

RENAULT

24.4123-1717.3**010985****Hauptbremszylinder**

Durchmesser [mm]: 23,8

Gewindemaß: M12x1

Anschlussanzahl: 2

MAPP-Code vorhanden:

Bremsystem: TRW

Ergänzungsartikel/Ergänzende Info 2: ohne Bremsflüssigkeitsbehälter

Länge 1 [mm]: 5,8

Länge 2 [mm]: 111,2

OPEL, VAUXHALL**24.4123-1718.3****011016****Hauptbremszylinder**

Durchmesser [mm]: 23,8

Gewindemaß: M12x1

Anschlussanzahl: 2

MAPP-Code vorhanden:

Bremsystem: TRW

Ergänzungsartikel/Ergänzende Info 2: ohne Bremsflüssigkeitsbehälter

Länge 1 [mm]: 30,3

Länge 2 [mm]: 102,5

MERCEDES-BENZ**24.4123-1719.3****011017****Hauptbremszylinder**

Durchmesser [mm]: 23,8

Gewindemaß: M12x1

Anschlussanzahl: 2

MAPP-Code vorhanden:

Bremsystem: TRW

Ergänzungsartikel/Ergänzende Info 2: ohne Bremsflüssigkeitsbehälter

Länge 1 [mm]: 5

Länge 2 [mm]: 126

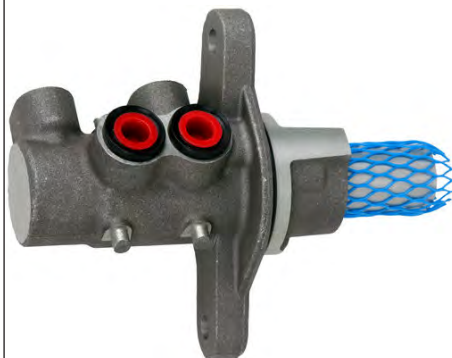
AUDI, CUPRA, SEAT, SKODA, VW**24.4123-1720.3****011022****Hauptbremszylinder**

Durchmesser [mm]: 23,8

Gewindemaß: M10x1

Anschlussanzahl: 2

MAPP-Code vorhanden:

Bremsystem: BOS

Ergänzungsartikel/Ergänzende Info 2: ohne Bremsflüssigkeitsbehälter

Länge 1 [mm]: 32

Länge 2 [mm]: 79,9

ABARTH, ALFA ROMEO, OPEL, VAUXHALL

24.4123-1721.3**011052****Hauptbremszylinder**

Durchmesser [mm]: 23,8

Gewindemaß: M12x1

Anschlussanzahl: 2

Material: Aluguss

MAPP-Code vorhanden:

Bremsystem: BOS

Ergänzungsartikel/Ergänzende Info 2: ohne Bremsflüssigkeitsbehälter

Länge 1 [mm]: 32

Länge 2 [mm]: 82

RENAULT**24.4123-1722.3****011071****Hauptbremszylinder**

Durchmesser [mm]: 23,8

Gewindemaß: M12x1

Anschlussanzahl: 2

Material: Aluguss

MAPP-Code vorhanden:

Ergänzungsartikel/Ergänzende Info 2: ohne Bremsflüssigkeitsbehälter

Länge 1 [mm]: 32

Länge 2 [mm]: 79,9

OPEL, VAUXHALL**24.4123-1723.3****011074****Hauptbremszylinder**

Durchmesser [mm]: 23,8

Gewindemaß: M12x1

Anschlussanzahl: 2

Material: Aluguss

MAPP-Code vorhanden:

Ergänzungsartikel/Ergänzende Info 2: ohne Bremsflüssigkeitsbehälter

Länge 1 [mm]: 34

Länge 2 [mm]: 116

RENAULT**24.4123-1724.3****011075****Hauptbremszylinder**

Durchmesser [mm]: 23,8

Gewindemaß: M12x1

Anschlussanzahl: 2

Material: Aluguss

MAPP-Code vorhanden:

Bremsystem: TRW

Ergänzungsartikel/Ergänzende Info 2: ohne Bremsflüssigkeitsbehälter

Länge 1 [mm]: 5,5

Länge 2 [mm]: 107

RENAULT

24.4123-1725.3**011073****Hauptbremszylinder**

Durchmesser [mm]: 23,8

Gewindemaß: M12x1

Anschlussanzahl: 2

Material: Aluguss

MAPP-Code vorhanden:

Ergänzungsartikel/Ergänzende Info 2: ohne Bremsflüssigkeitsbehälter

Länge 1 [mm]: 32

Länge 2 [mm]: 84

NISSAN**24.4123-1727.3****011088****Hauptbremszylinder**

Durchmesser [mm]: 23,8

Gewindemaß: M12x1

Anschlussanzahl: 2

Material: Aluguss

MAPP-Code vorhanden:

Ergänzungsartikel/Ergänzende Info 2: ohne Bremsflüssigkeitsbehälter

Länge 1 [mm]: 13,5

Länge 2 [mm]: 97,4

NISSAN**24.4123-1728.3****011089****Hauptbremszylinder**

Durchmesser [mm]: 23,8

Gewindemaß: M12x1

Anschlussanzahl: 2

Material: Aluguss

MAPP-Code vorhanden:

Ergänzungsartikel/Ergänzende Info 2: ohne Bremsflüssigkeitsbehälter

Länge 1 [mm]: 20

Länge 2 [mm]: 91

NISSAN, RENAULT**24.4123-1729.3****011106****Hauptbremszylinder**

Durchmesser [mm]: 23,8

Gewindemaß: M10x1

Anschlussanzahl: 2

Material: Aluguss

MAPP-Code vorhanden:

Ergänzungsartikel/Ergänzende Info 2: ohne Bremsflüssigkeitsbehälter

Länge 1 [mm]: 32

Länge 2 [mm]: 84

NISSAN

24.4123-1730.3**011097****Hauptbremszylinder**

Durchmesser [mm]: 23,8

Gewindemaß: M12x1

Anschlussanzahl: 2

Material: Aluguss

MAPP-Code vorhanden:

Ergänzungsartikel/Ergänzende Info 2: ohne Bremsflüssigkeitsbehälter

Länge 1 [mm]: 32

CITROËN, PEUGEOT**24.4123-1731.3****011094****Hauptbremszylinder**

Durchmesser [mm]: 23,8

Gewindemaß: M12x1

Anschlussanzahl: 2

Material: Aluguss

MAPP-Code vorhanden:

Ergänzungsartikel/Ergänzende Info 2: ohne Bremsflüssigkeitsbehälter

Länge 1 [mm]: 32

FIAT, JEEP**24.4123-1733.3****011108****Hauptbremszylinder**

Durchmesser [mm]: 23,8

Gewindemaß: M12x1

Anschlussanzahl: 2

Material: Aluguss

MAPP-Code vorhanden:

Ergänzungsartikel/Ergänzende Info 2: ohne Bremsflüssigkeitsbehälter

Länge 1 [mm]: 27

Länge 2 [mm]: 92

BMW, MINI**24.4123-1736.3****011118****Hauptbremszylinder**

Durchmesser [mm]: 23,8

Gewindemaß: M12x1

Anschlussanzahl: 2

Material: Aluguss

MAPP-Code vorhanden:

Ergänzungsartikel/Ergänzende Info 2: ohne Bremsflüssigkeitsbehälter

Länge 1 [mm]: 19

Länge 2 [mm]: 90

BMW

24.4123-1737.3**011119****Hauptbremszylinder**

Durchmesser [mm]: 23,8

Gewindemaß: M12x1

Anschlussanzahl: 2

Material: Aluguss

MAPP-Code vorhanden:

Ergänzungsartikel/Ergänzende Info 2: ohne Bremsflüssigkeitsbehälter

Länge 1 [mm]: 29

Länge 2 [mm]: 102

HYUNDAI**24.4123-1738.3****011124****Hauptbremszylinder**

Durchmesser [mm]: 23,8

Gewindemaß: M12x1

Anschlussanzahl: 2

Material: Aluguss

MAPP-Code vorhanden:

Ergänzungsartikel/Ergänzende Info 2: ohne Bremsflüssigkeitsbehälter

Länge 1 [mm]: 22

Länge 2 [mm]: 86,6

CHEVROLET, OPEL, VAUXHALL**24.4125-1701.3****010867****Hauptbremszylinder**

Durchmesser [mm]: 25,4

Gewindemaß: M12x1

Anschlussanzahl: 2

MAPP-Code vorhanden:

Bremsystem: BOS

Ergänzungsartikel/Ergänzende Info 2: ohne Bremsflüssigkeitsbehälter

Länge 1 [mm]: 10,5

Länge 2 [mm]: 126,5

CITROËN, FIAT, PEUGEOT**24.4125-1702.3****010872****Hauptbremszylinder**

Durchmesser [mm]: 25,4

Gewindemaß: M10x1

Anschlussanzahl: 2

MAPP-Code vorhanden:

Bremsystem: BOS

Ergänzungsartikel/Ergänzende Info 2: ohne Bremsflüssigkeitsbehälter

Länge 1 [mm]: 10,5

Länge 2 [mm]: 126,5

CITROËN, FIAT, PEUGEOT

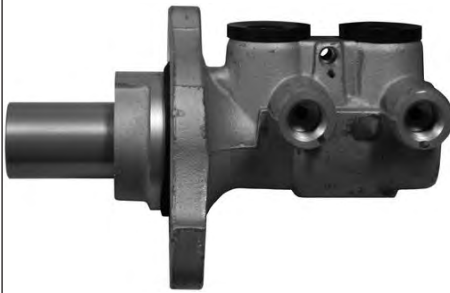
24.4125-1703.3**010907****Hauptbremszylinder**

Durchmesser [mm]: 25,4

Gewindemaß: M12x1

Anschlussanzahl: 2

MAPP-Code vorhanden:

Bremsssystem: TRW

Länge 1 [mm]: 18

Länge 2 [mm]: 90,5

OPEL, VAUXHALL**24.4125-1704.3****010908****Hauptbremszylinder**

Durchmesser [mm]: 25,4

Anschlussanzahl: 2

MAPP-Code vorhanden:

Bremsssystem: TRW

Gewindemaß 1: M10x1

Gewindemaß 2: M12x1

Länge 1 [mm]: 18

Länge 2 [mm]: 90,5

OPEL, VAUXHALL**24.4125-1708.3****011055****Hauptbremszylinder**

Durchmesser [mm]: 25,4

Gewindemaß: M12x1

Anschlussanzahl: 2

Material: Aluguss

MAPP-Code vorhanden:

Ergänzungsartikel/Ergänzende Info 2: ohne Bremsflüssigkeitsbehälter

Länge 1 [mm]: 32,7

Länge 2 [mm]: 86,5

FORD**24.4125-1709.3****011077****Hauptbremszylinder**

Durchmesser [mm]: 25,4

Gewindemaß: M12x1

Anschlussanzahl: 2

Material: Aluguss

MAPP-Code vorhanden:

Bremsssystem: TRW

Ergänzungsartikel/Ergänzende Info 2: ohne Bremsflüssigkeitsbehälter

Länge 1 [mm]: 17,5

Länge 2 [mm]: 92

BMW

24.4125-1713.3**011109****Hauptbremszylinder**

Durchmesser [mm]: 25,4

Gewindemaß: M12x1

Anschlussanzahl: 2

Material: Aluguss

Ergänzungsartikel/Ergänzende Info 2: ohne Bremsflüssigkeitsbehälter

Länge 1 [mm]: 19

Länge 2 [mm]: 90

BMW**24.4126-1701.3****010868****Hauptbremszylinder**

Durchmesser [mm]: 27

Gewindemaß: M12x1

Anschlussanzahl: 2

MAPP-Code vorhanden:

Bremsystem: BOS

Ergänzungsartikel/Ergänzende Info 2: ohne Bremsflüssigkeitsbehälter

Länge 1 [mm]: 10,5

Länge 2 [mm]: 126,5

CITROËN, FIAT, PEUGEOT**24.4126-1702.3****010875****Hauptbremszylinder**

Durchmesser [mm]: 27

Gewindemaß: M10x1

Anschlussanzahl: 2

MAPP-Code vorhanden:

Bremsystem: BOS

Ergänzungsartikel/Ergänzende Info 2: ohne Bremsflüssigkeitsbehälter

Länge 1 [mm]: 10,5

Länge 2 [mm]: 126,5

CITROËN, FIAT, PEUGEOT**24.4150-1071.3****011046****Hauptbremszylinder**

Durchmesser [mm]: 20,6

Gewindemaß: M12x1

Anschlussanzahl: 2

Material: Aluguss

MAPP-Code vorhanden:

Bremsystem: ATE

Ergänzungsartikel/Ergänzende Info 2: ohne Bremsflüssigkeitsbehälter

Länge 1 [mm]: 25,8

Länge 2 [mm]: 86,1

RENAULT, SMART

24.4152-0132.3**011025****Hauptbremszylinder**

Durchmesser [mm]: 22,2

Gewindemaß: M12x1

Anschlussanzahl: 2

MAPP-Code vorhanden:

Bremsystem: ATE

Ergänzungsartikel/Ergänzende Info 2: ohne Bremsflüssigkeitsbehälter

Länge 1 [mm]: 116,8

Länge 2 [mm]: 38,1

SEAT, SKODA, VW**24.4152-0381.3****011032****Hauptbremszylinder**

Durchmesser [mm]: 22,2

Gewindemaß: M10x1

Anschlussanzahl: 2

MAPP-Code vorhanden:

Bremsystem: ATE

Ergänzungsartikel/Ergänzende Info 2: ohne Bremsflüssigkeitsbehälter

Länge 1 [mm]: 108,3

Länge 2 [mm]: 6,6

DACIA, RENAULT**24.4152-0391.3****011033****Hauptbremszylinder**

Durchmesser [mm]: 22,2

Gewindemaß: M12x1

Anschlussanzahl: 2

MAPP-Code vorhanden:

Bremsystem: ATE

Ergänzungsartikel/Ergänzende Info 2: ohne Bremsflüssigkeitsbehälter

Länge 1 [mm]: 108,3

Länge 2 [mm]: 6,6

DACIA, RENAULT**24.4153-0192.3****011026****Hauptbremszylinder**

Durchmesser [mm]: 23,8

Gewindemaß: M12x1

Anschlussanzahl: 2

MAPP-Code vorhanden:

Bremsystem: ATE

Ergänzungsartikel/Ergänzende Info 2: ohne Bremsflüssigkeitsbehälter

Länge 1 [mm]: 116,8

Länge 2 [mm]: 38,1

AUDI, VW

24.4153-0202.3**011027****Hauptbremszylinder**

Durchmesser [mm]: 23,8

Gewindemaß: M12x1

Anschlussanzahl: 2

MAPP-Code vorhanden:

Bremsystem: ATE

Ergänzungsartikel/Ergänzende Info 2: ohne Bremsflüssigkeitsbehälter

Länge 1 [mm]: 38,1

Länge 2 [mm]: 105,7

SEAT, SKODA, VW**24.4153-0217.3****011039****Hauptbremszylinder**

Durchmesser [mm]: 23,8

Gewindemaß: M12x1

Anschlussanzahl: 2

MAPP-Code vorhanden:

Bremsystem: ATE

Ergänzungsartikel/Ergänzende Info 2: ohne Bremsflüssigkeitsbehälter

Länge 1 [mm]: 38,1

Länge 2 [mm]: 116,8

AUDI**24.4153-0222.3****011047****Hauptbremszylinder**

Durchmesser [mm]: 23,8

Gewindemaß: M12x1

Anschlussanzahl: 2

Material: Aluguss

MAPP-Code vorhanden:

Bremsystem: ATE

Ergänzungsartikel/Ergänzende Info 2: ohne Bremsflüssigkeitsbehälter

Länge 1 [mm]: 38,1

Länge 2 [mm]: 116,8

SEAT, VW**24.4153-1522.3****011048****Hauptbremszylinder**

Durchmesser [mm]: 23,8

Gewindemaß: M12x1

Anschlussanzahl: 2

Material: Aluguss

MAPP-Code vorhanden:

Bremsystem: ATE

Ergänzungsartikel/Ergänzende Info 2: ohne Bremsflüssigkeitsbehälter

Länge 1 [mm]: 18

Länge 2 [mm]: 123,3

AUDI, CUPRA, SEAT, SKODA, VW

24.4155-0201.3**011125****Hauptbremszylinder**

Durchmesser [mm]: 25,4

Gewindemaß: M12x1

Anschlussanzahl: 2

MAPP-Code vorhanden:

Bremsystem: ATE

Ergänzungsartikel/Ergänzende Info 2: ohne Bremsflüssigkeitsbehälter

Länge 1 [mm]: 25,7

Länge 2 [mm]: 89,2

CHEVROLET, OPEL, SAAB, VAUXHALL**24.4155-1236.3****011049****Hauptbremszylinder**

Durchmesser [mm]: 25,4

Gewindemaß: M12x1

Anschlussanzahl: 2

Material: Aluguss

MAPP-Code vorhanden:

Bremsystem: ATE

Ergänzungsartikel/Ergänzende Info 2: ohne Bremsflüssigkeitsbehälter

Länge 1 [mm]: 31,7

Länge 2 [mm]: 92

CITROËN, DS**24.4155-1311.3****011053****Hauptbremszylinder**

Durchmesser [mm]: 25,4

Gewindemaß: M12x1

Anschlussanzahl: 2

Material: Aluguss

MAPP-Code vorhanden:

Bremsystem: ATE

Ergänzungsartikel/Ergänzende Info 2: ohne Bremsflüssigkeitsbehälter

Länge 1 [mm]: 30,1

Länge 2 [mm]: 93,8

CITROËN, PEUGEOT**24.4156-1016.3****011068****Hauptbremszylinder**

Durchmesser [mm]: 27

Gewindemaß: M12x1

Anschlussanzahl: 2

MAPP-Code vorhanden:

Bremsystem: ATE

Länge 1 [mm]: 19,5

Länge 2 [mm]: 90

JAGUAR

24.4156-1051.3**011069****Hauptbremszylinder**

Durchmesser [mm]: 27

Gewindemaß: M12x1

Anschlussanzahl: 2

MAPP-Code vorhanden:

Bremsystem: ATE

Ergänzungsartikel/Ergänzende Info 2: ohne Bremsflüssigkeitsbehälter

Länge 1 [mm]: 19,8

Länge 2 [mm]: 90

JAGUAR**24.4156-1076.3****011070****Hauptbremszylinder**

Durchmesser [mm]: 27

Gewindemaß: M12x1

Anschlussanzahl: 2

MAPP-Code vorhanden:

Bremsystem: ATE

Ergänzungsartikel/Ergänzende Info 2: ohne Bremsflüssigkeitsbehälter

Länge 1 [mm]: 19,5

Länge 2 [mm]: 90

JAGUAR**24.4156-1136.3****011126****Hauptbremszylinder**

Durchmesser [mm]: 27

Gewindemaß: M12x1

Anschlussanzahl: 2

MAPP-Code vorhanden:

Bremsystem: ATE

Ergänzungsartikel/Ergänzende Info 2: ohne Bremsflüssigkeitsbehälter

Länge 1 [mm]: 28,7

Länge 2 [mm]: 80,2

MERCEDES-BENZ**24.4156-1221.3****011127****Hauptbremszylinder**

Durchmesser [mm]: 27

Gewindemaß: M12x1

Anschlussanzahl: 2

MAPP-Code vorhanden:

Bremsystem: ATE

Ergänzungsartikel/Ergänzende Info 2: ohne Bremsflüssigkeitsbehälter

Länge 1 [mm]: 30,7

Länge 2 [mm]: 84,2

MERCEDES-BENZ

24.4156-1270.3**011058****Hauptbremszylinder**

Durchmesser [mm]: 27

Gewindemaß: M14x1

Anschlussanzahl: 2

Material: Aluguss

MAPP-Code vorhanden:

Bremsystem: ATE

Ergänzungsartikel/Ergänzende Info 2: ohne Bremsflüssigkeitsbehälter

Länge 1 [mm]: 13,4

Länge 2 [mm]: 101,5

LAND ROVER**24.4156-1391.3****011054****Hauptbremszylinder**

Durchmesser [mm]: 27

Gewindemaß: M12x1

Anschlussanzahl: 2

Material: Aluguss

MAPP-Code vorhanden:

Bremsystem: ATE

Ergänzungsartikel/Ergänzende Info 2: ohne Bremsflüssigkeitsbehälter

Länge 1 [mm]: 13,4

Länge 2 [mm]: 101,5

VOLVO**24.9145-0003.2****399007****Hydraulikaggregat, Bremsanlage**

für OE-Nummer: 34 51 6 863 354

Ergänzungsartikel/Ergänzende Info: ohne Steuergerät

Montageinformation beachten:

Bremsystem: hyd.

Brems-/Fahrndynamik: + ESP

BMW

24.9145-0004.2

399008



Hydraulikaggregat, Bremsanlage

Ergänzungsartikel/Ergänzende Info: ohne Steuergerät

Montageinformation beachten:

Bremssystem: hyd.

Brems-/Fahrtdynamik: + ESP

FORD



DE Fahrzeugverwendungen

EN Applications of vehicles

















ES Aplicaciones















FR Applications















IT Applicazioni autoveicoli











2024









	kw			 	! #		
ABARTH - 500 / 595 / 695 01/08→							
 Hauptbremszylinder							
1.4	99 - 140	08/08→				24.4122-1714.3 010914	TRW Ø 22,2 ohne Bremsflüssigkeitsbehälter
ABARTH - 500C / 595C / 695C 05/08→							
 Hauptbremszylinder							
1.4	99 - 132	05/08→				24.4122-1714.3 010914	TRW Ø 22,2 ohne Bremsflüssigkeitsbehälter
ABARTH - GRANDE PUNTO 07/07→06/10							
 Hauptbremszylinder							
1.4 1.4 ESSEESSE / SUPERSPORT	114 132	07/07→06/10 05/08→06/10				24.4123-1720.3 011022	BOS Ø 23,8 ohne Bremsflüssigkeitsbehälter
ABARTH - PUNTO 03/12→							
 Hauptbremszylinder							
1.4 1.4 SUPERSPORT	120 132	03/12→ 03/12→		für Linkslenker		24.4123-1720.3 011022	BOS Ø 23,8 ohne Bremsflüssigkeitsbehälter
ABARTH - PUNTO EVO 07/08→02/12							
 Hauptbremszylinder							
1.4	120	10/09→02/12		für Linkslenker		24.4123-1720.3 011022	BOS Ø 23,8 ohne Bremsflüssigkeitsbehälter
ALFA ROMEO - 145 (930_) 07/94→01/01							
 Hauptbremszylinder							
1.4 i.e. 16V T.S. 1.6 i.e. 16V T.S.	76 88	12/96→01/01 12/96→01/01		01/97→; GG		24.2122-1716.3 010485	Ø 22,2
1.6 16V T.S. 1.8 i.e. 16V 1.9 JTD 1.9 TD 2.0 16V 2.0 16V T.S.	82 106 77 66 114 110	09/97→12/00 03/98→01/01 02/99→01/01 10/94→02/99 03/98→01/01 10/95→01/01		GG		24.2122-1716.3 010485	Ø 22,2
ALFA ROMEO - 146 (930_) 12/94→10/01							
 Hauptbremszylinder							
1.4 i.e. 16V T.S. 1.6 i.e. 16V T.S. 1.8 i.e. 16V T.S.	76 88 103	11/96→01/01 11/96→10/01 11/96→01/01		01/97→; GG		24.2122-1716.3 010485	Ø 22,2
1.6 16V T.S. 1.8 i.e. 16V T.S. 1.9 JTD 1.9 TD 2.0 16V 2.0 16V T.S.	82 106 77 66 114 110	09/97→12/00 03/98→01/01 02/99→01/01 12/94→02/99 03/97→10/01 10/95→01/01		GG		24.2122-1716.3 010485	Ø 22,2
ALFA ROMEO - 159 (939_) 06/05→12/12							
 Hauptbremszylinder							
1.8 MPI 1.9 JTDM 16V 1.9 JTDM 8V 1.9 JTS 2.2 JTS 2.4 JTDM 2.4 JTDM Q4 3.2 JTS 3.2 JTS Q4	103 100 - 110 85 - 88 118 136 147 - 154 154 191 191	06/05→11/11 09/05→11/11 09/05→11/11 09/05→11/11 09/05→11/11 09/05→11/11 05/07→11/11 01/08→11/11 12/05→11/11		→ 06/08; für Fahrzeuge mit elektronischer Fahrdynamikregelung		24.2125-1732.3 010827	TRW Ø 25,4
ALFA ROMEO - 159 Sportwagon (939_) 06/05→12/12							
 Hauptbremszylinder							
1.8 MPI 1.9 JTDM 16V 1.9 JTDM 8V 1.9 JTS 2.2 JTS →	103 100 - 110 85 - 88 118 136	06/05→11/11 03/06→11/11 03/06→11/11 03/06→11/11 03/06→11/11		→ 06/08; für Fahrzeuge mit elektronischer Fahrdynamikregelung		24.2125-1732.3 010827	TRW Ø 25,4

	kw					! #		
ALFA ROMEO - 159 Sportwagon (939_) 06/05→12/12								
 Hauptbremszylinder								
2.4 JTDM 2.4 JTDM Q4 3.2 JTS 3.2 JTS Q4	147 - 154 154 191 191	03/06→12/12 05/07→11/11 02/08→11/11 03/06→11/11			→ 06/08; für Fahrzeuge mit elektronischer Fahrdynamikregelung		24.2125-1732.3 010827	TRW Ø 25,4
ALFA ROMEO - 166 (936_) 09/98→06/07								
 Hauptbremszylinder								
2.0 T.Spark 2.0 V6 2.4 JTD 2.5 V6 24V 3.0 V6 24V	114 151 100 140 166	09/98→10/00 09/98→10/00 09/98→10/00 09/98→12/06 09/98→06/07			10/98→; für Fahrzeuge mit elektronischer Fahrdynamikregelung		24.2125-1729.3 010752	Ø 25,4
2.0 T.Spark	110	10/00→06/07			→ 10/00; für Fahrzeuge mit elektronischer Fahrdynamikregelung		24.2125-1729.3 010752	Ø 25,4
2.4 JTD 2.5 V6 24V 3.0 V6 24V 3.2 V6 24V	103 - 136 138 162 176	10/00→06/07 10/00→06/07 10/00→06/07 10/03→06/07			für Fahrzeuge mit elektronischer Fahrdynamikregelung		24.2125-1729.3 010752	Ø 25,4
ALFA ROMEO - BRERA (939_) 01/06→05/11								
 Hauptbremszylinder								
1.8 TBi 2.0 JTDM 2.2 JTS 2.4 JTDM 20V 3.2 JTS 3.2 JTS Q4	147 125 136 147 - 154 191 191	05/09→06/10 05/09→06/10 01/06→05/11 01/06→03/11 03/08→06/10 01/06→05/11					24.2125-1732.3 010827	TRW Ø 25,4
2.0 JTDM	120	03/08→06/10			05/09→		24.2125-1732.3 010827	TRW Ø 25,4
ALFA ROMEO - GIULIETTA (940_) 04/10→12/20								
 Hauptbremszylinder								
1.4 BiFuel 1.4 TB 1.6 JTDM 1.8 TBi 2.0 JTDM	88 77 - 125 77 - 88 169 - 177 100 - 129	12/11→02/17 04/10→12/20 04/10→12/20 04/10→10/18 04/10→12/20					03.2123-3571.3 010962	ATE Ø 23,8
ALFA ROMEO - GIULIETTA Kasten/Schrägheck (940_) 04/11→12/20								
 Hauptbremszylinder								
1.4 1.6 JTDM 1.8 2.0 JTDM	88 125 77 173 103 - 129	04/11→12/20 04/11→02/16 04/11→02/16 04/11→12/20					03.2123-3571.3 010962	ATE Ø 23,8
ALFA ROMEO - GTV (916_) 09/94→10/05								
 Hauptbremszylinder								
1.8 16V 2.0 JTS 2.0 T.SPARK 16V 3.0 V6 24V 3.2 V6 24V	106 121 110 - 114 160 - 162 176	05/98→10/05 04/03→10/05 06/95→10/05 10/96→10/05 04/03→10/05			GG		24.2122-1716.3 010485	Ø 22,2
ALFA ROMEO - MITO (955_) 08/08→10/18								
 Hauptbremszylinder								
0.9 TwinAir 1.4 1.4 MultiAir 1.3 MultiJet 1.4 Bifuel 1.4 MultiAir 1.4 TB →	63 - 77 58 - 70 77 59 - 70 88 125 103	07/11→08/18 08/08→08/13 09/09→08/13 08/08→10/18 01/09→10/18 09/09→10/18 12/13→10/18					24.4122-1709.3 010871 24.4123-1720.3 011022	BOS Ø 22,2 ohne Bremsflüssigkeitsbehälter BOS Ø 23,8 ohne Bremsflüssigkeitsbehälter

	kw					! #		
ALFA ROMEO - MITO (955_) 08/08→10/18								
 Hauptbremszylinder								
1.4 TJet	88 - 114	08/08→08/13					24.4123-1720.3 011022	BOS Ø 23,8 ohne Bremsflüssigkeitsbehälter
1.4 Turbo MultiAir	99 - 120	10/09→10/18						
1.6 JTDM	85 - 88	08/08→08/15						
1.4	57	03/11→10/18		05/11→			24.4122-1709.3 010871	BOS Ø 22,2 ohne Bremsflüssigkeitsbehälter
							24.4123-1720.3 011022	BOS Ø 23,8 ohne Bremsflüssigkeitsbehälter
1.4	51	05/11→10/18					24.4122-1709.3 010871	BOS Ø 22,2 ohne Bremsflüssigkeitsbehälter
							24.4123-1720.3 011022	BOS Ø 23,8 ohne Bremsflüssigkeitsbehälter
ALFA ROMEO - SPIDER (916_) 09/94→04/05								
 Hauptbremszylinder								
1.8 16V	106	05/98→04/05		GG			24.2122-1716.3 010485	Ø 22,2
2.0 JTS	121	04/03→04/05						
2.0 T.SPARK 16V	110 - 114	06/95→04/05						
2.0 V6 Turbo	148	05/98→04/05						
3.0 V6	141	06/95→04/05						
3.0 V6 24V	162	01/99→10/03						
3.2 V6 24V	176	04/03→04/05						
3.0 V6	160	09/94→04/05		10/00→; GG			24.2122-1716.3 010485	Ø 22,2
ALFA ROMEO - SPIDER (939_) 03/06→03/11								
 Hauptbremszylinder								
2.2 JTS	136	03/06→03/11		04/06→ 09/06			24.2125-1732.3 010827	TRW Ø 25,4
3.2 JTS Q4	191	03/06→03/11						
AUDI - A1 (8X1, 8XK) 05/10→10/18								
 Hauptbremszylinder								
2.0 TFSI quattro	188	03/12→11/12		10/12→; für Linkslenker			03.2125-5112.3 010966	ATE Ø 25,4
AUDI - A2 (8Z0) 02/00→08/05								
 Bremskraftverstärker								
1.2 TDI	45	03/01→08/05		8Z-2-013001→; für Linkslenker; → 07/05			03.7850-0102.4 300180	ATE Ø 9" pneumatisch
				→ 8Z-2-013000; für Linkslenker			03.7853-0202.4 300181	ATE Ø 9" pneumatisch
1.4	55	02/00→08/05		8Z-2-013001→; für Linkslenker; → 07/05			03.7850-0102.4 300180	ATE Ø 9" pneumatisch
1.4 TDI	55	02/00→08/05		06/00→; → 8Z-2-013000; für Linkslenker			03.7853-0202.4 300181	ATE Ø 9" pneumatisch
1.4 TDI	66	11/03→08/05		für Linkslenker; → 07/05			03.7850-0102.4 300180	ATE Ø 9" pneumatisch
1.6 FSI	81	05/02→08/05						
 Hauptbremszylinder								
1.2 TDI	45	03/01→08/05		8Z-3-019001→; → 07/05			03.2122-1888.3 010736	ATE Ø 22,2
1.4	55	02/00→08/05						
1.4 TDI	55	02/00→08/05						
1.6 FSI	81	05/02→08/05						
1.4 TDI	66	11/03→08/05		→ 07/05			03.2122-1888.3 010736	ATE Ø 22,2
AUDI - A3 (8L1) 09/96→09/06								
 Bremskraftverstärker								
1.6	74 - 75	09/96→05/03		09/00→; → 8L-2-037877; für Linkslenker; + ESP			03.7860-0602.4 300141	ATE Ø 10" pneumatisch
1.8	92	09/96→05/03		→ 08/00; für Linkslenker; + ESP			03.7863-0402.4 300124	ATE Ø 10" pneumatisch
1.8 T	110 - 132	12/96→05/03		8L-2-037878→; für Linkslenker; + ESP			03.7863-3502.4 300128	ATE Ø 10" pneumatisch
1.8 T quattro	132	10/98→05/03						
S3 quattro	154	03/99→04/02						
1.8 T quattro	110	12/96→05/03		09/00→; → 8L-2-037877; für Linkslenker; + ESP			03.7860-0602.4 300141	ATE Ø 10" pneumatisch
				08/98→ 08/00; für Linkslenker; + ESP			03.7863-0402.4 300124	ATE Ø 10" pneumatisch
				8L-2-037878→; für Linkslenker; + ESP			03.7863-3502.4 300128	ATE Ø 10" pneumatisch
1.9 TDI	66 - 81	09/96→07/01		09/00→ 06/01; für Linkslenker; + ESP			03.7860-0602.4 300141	ATE Ø 10" pneumatisch
				→ 08/00; für Linkslenker; + ESP			03.7863-0402.4 300124	ATE Ø 10" pneumatisch
1.9 TDI	74	10/00→05/03		→ 8L-2-037877; für Linkslenker; + ESP			03.7860-0602.4 300141	ATE Ø 10" pneumatisch
S3 quattro	165	10/01→05/03		8L-2-037878→; für Linkslenker; + ESP			03.7863-3502.4 300128	ATE Ø 10" pneumatisch
→								

	kw			 	! #		
AUDI - A3 (8L1) 09/96→09/06							
 Bremskraftverstärker							
1.9 TDI 1.9 TDI quattro	96 96	08/00→05/03 08/00→05/03		09/00→; → 8L-2-037877; für Linkslenker; + ESP	03.7860-0602.4	300141	ATE Ø 10" pneumatisch
				8L-2-037878→; für Linkslenker; + ESP	03.7863-3502.4	300128	ATE Ø 10" pneumatisch
 Hauptbremszylinder							
1.6	74 - 75	09/96→05/03		→ 08/00; für Linkslenker; + ESP	03.2123-2024.3	010597	ATE Ø 23,8
1.8	92	09/96→05/03		09/00→; für Linkslenker; + ESP	03.2123-2715.3	010802	ATE Ø 23,8
1.8 T	110 - 132	12/96→05/03		09/00→; für Rechtslenker; + ESP	03.2123-2774.3	010803	ATE Ø 23,8
S3 quattro	154	03/99→04/02		für Linkslenker; - ESP	24.2123-1709.3	010503	Ø 23,8
1.8 T quattro	110	12/96→05/03		09/00→; für Linkslenker; + ESP	03.2123-2715.3	010802	ATE Ø 23,8
				09/00→; für Rechtslenker; + ESP	03.2123-2774.3	010803	ATE Ø 23,8
				08/98→; - ESP; für Linkslenker	24.2123-1709.3	010503	Ø 23,8
1.8 T quattro	132	10/98→05/03		09/00→; für Linkslenker; + ESP	03.2123-2715.3	010802	ATE Ø 23,8
				09/00→; für Rechtslenker; + ESP	03.2123-2774.3	010803	ATE Ø 23,8
				für Linkslenker; - ESP	24.2123-1709.3	010503	Ø 23,8
1.9 TDI	66 - 81	09/96→07/01		→ 08/00; für Linkslenker; + ESP	03.2123-2024.3	010597	ATE Ø 23,8
				09/00→ 06/01; für Linkslenker; + ESP	03.2123-2715.3	010802	ATE Ø 23,8
				09/00→ 06/01; für Rechtslenker; + ESP	03.2123-2774.3	010803	ATE Ø 23,8
				→ 06/01; für Linkslenker; - ESP	24.2123-1709.3	010503	Ø 23,8
1.9 TDI S3 quattro	74 165	10/00→05/03 10/01→05/03		für Linkslenker; + ESP	03.2123-2715.3	010802	ATE Ø 23,8
				für Rechtslenker; + ESP	03.2123-2774.3	010803	ATE Ø 23,8
				für Linkslenker; - ESP	24.2123-1709.3	010503	Ø 23,8
1.9 TDI 1.9 TDI quattro	96 96	08/00→05/03 08/00→05/03		09/00→; für Linkslenker; + ESP	03.2123-2715.3	010802	ATE Ø 23,8
				09/00→; für Rechtslenker; + ESP	03.2123-2774.3	010803	ATE Ø 23,8
				09/00→; für Linkslenker; - ESP	24.2123-1709.3	010503	Ø 23,8
AUDI - A3 (8P1) 05/03→12/13							
 Bremskraftverstärker							
1.2 TSI 1.4 TFSI 1.6 1.6 E-Power 1.6 FSI 1.6 TDI	77 92 75 75 85 66 - 77	04/10→08/12 09/07→08/12 05/03→08/12 01/11→08/12 08/03→09/07 05/09→08/12		für Linkslenker; +PR 1AC / 1AT	03.7863-3232.4	300307	ATE Ø 10" pneumatisch
1.8 TFSI quattro 2.0 FSI 2.0 TDI	118 110 100 -	07/08→08/12 05/03→06/08 05/03→08/12					
2.0 TDI 16V 2.0 TDI 16V quattro 2.0 TDI quattro	125 103 100 -	05/03→08/12 08/04→08/12 05/03→08/12					
2.0 TFSI 2.0 TFSI quattro	147 147	09/04→08/12 09/04→08/12					
1.8 T 1.8 TFSI	110 118	08/06→08/12 11/06→08/12		01/07→; +PR 1AC / 1AT; für Linkslenker	03.7863-3232.4	300307	ATE Ø 10" pneumatisch
1.9 TDI	77	05/03→05/10		06/03→; für Linkslenker; +PR 1AC / 1AT	03.7863-3232.4	300307	ATE Ø 10" pneumatisch
3.2 V6 quattro S3 quattro	184 195	07/03→05/09 11/06→08/12		für Linkslenker	03.7863-3332.4	300308	ATE Ø 10" pneumatisch
S3 quattro	188	02/07→08/12		07/08→; für Linkslenker	03.7863-3332.4	300308	ATE Ø 10" pneumatisch
 Hauptbremszylinder							
1.2 TSI	77	04/10→08/12		für Linkslenker; +PR 1ZE / 1ZF / 1ZP / 1ZD / 1LJ / 1ZM	03.2122-2129.3	010799	ATE Ø 22,2
				8P-6A094001→; für Linkslenker; +PR 1ZE / 1ZF / 1ZP / 1ZD / 1LJ / 1ZM	03.2122-2129.3	010799	ATE Ø 22,2
				für Linkslenker; → 8P-6B009600; +PR 1ZE / 1ZF / 1ZP / 1ZD / 1LJ / 1ZM	03.2122-2129.3	010799	ATE Ø 22,2
				für Linkslenker; → 8P-6A094000; +PR 1ZE / 1ZF / 1ZP / 1ZD / 1LJ / 1ZM	03.2122-2129.3	010799	ATE Ø 22,2
				8P-6A094001→; für Linkslenker; +PR 1LK / 1ZK	03.2123-3449.3	010808	ATE Ø 23,8
				für Linkslenker; +PR 1LK / 1ZK	03.2123-3449.3	010808	ATE Ø 23,8
				für Linkslenker; → 8P-6A094000; +PR 1LK	03.2123-3449.3	010808	ATE Ø 23,8
				für Linkslenker; → 8P-6B009600; +PR 1LK	03.2123-3449.3	010808	ATE Ø 23,8
→							

	kw			 	! #		
AUDI - A3 (8P1) 05/03→12/13							
Hauptbremszylinder							
1.2 TSI	77	04/10→08/12		für Rechtslenker		24.2122-1981.3 011024	ATE Ø 22,2 ohne Bremsflüssigkeitsbehälter
1.4 TFSI	92	09/07→08/12		für Linkslenker; +PR 1ZE / 1ZF / 1ZP / 1ZD / 1LJ / 1ZM		03.2122-2129.3 010799	ATE Ø 22,2
				für Linkslenker; +PR 1LK / 1ZK		03.2123-3449.3 010808	ATE Ø 23,8
				für Rechtslenker		24.2122-1981.3 011024	ATE Ø 22,2 ohne Bremsflüssigkeitsbehälter
1.6 1.6 E-Power 1.6 FSI 1.6 TDI 2.0 FSI 2.0 TDI 2.0 TDI 16V 2.0 TDI 16V quattro 2.0 TDI quattro	75	05/03→08/12		8P-6A094001→; für Linkslenker; +PR 1ZE / 1ZF / 1ZP / 1ZD / 1LJ / 1ZM		03.2122-2129.3 010799	ATE Ø 22,2
	75	01/11→08/12		8P-6A094001→; für Linkslenker; +PR 1ZE / 1ZF / 1ZP / 1ZD / 1LJ / 1ZM		03.2122-2129.3 010799	ATE Ø 22,2
	85	08/03→09/07		8P-6B009601→; für Linkslenker; +PR 1ZE / 1ZF / 1ZP / 1ZD / 1LJ / 1ZM		03.2122-2129.3 010799	ATE Ø 22,2
	66 - 77	05/09→08/12		für Linkslenker; → 8P-6A094000; +PR 1ZE / 1ZF / 1ZP / 1ZD / 1LJ / 1ZM		03.2122-2129.3 010799	ATE Ø 22,2
	110	05/03→06/08		für Linkslenker; → 8P-6B009600; +PR 1ZE / 1ZF / 1ZP / 1ZD / 1LJ / 1ZM		03.2122-2129.3 010799	ATE Ø 22,2
	100 - 103	05/03→08/12		für Linkslenker; → 8P-6B009600; +PR 1ZE / 1ZF / 1ZP / 1ZD / 1LJ / 1ZM		03.2122-2129.3 010799	ATE Ø 22,2
	103	05/03→08/12		8P-6B009601→; für Linkslenker; +PR 1LK / 1ZK		03.2123-3449.3 010808	ATE Ø 23,8
	103	08/04→08/12		8P-6A094001→; für Linkslenker; +PR 1LK / 1ZK		03.2123-3449.3 010808	ATE Ø 23,8
	100 - 103	05/03→06/08		für Linkslenker; → 8P-6A094000; +PR 1LK		03.2123-3449.3 010808	ATE Ø 23,8
				für Linkslenker; → 8P-6B009600; +PR 1LK		03.2123-3449.3 010808	ATE Ø 23,8
1.8 T 1.8 TFSI	110	08/06→08/12		01/07→; für Linkslenker; +PR 1ZE / 1ZF / 1ZP / 1ZD / 1LJ / 1ZM		03.2122-2129.3 010799	ATE Ø 22,2
	118	11/06→08/12		01/07→; für Linkslenker; +PR 1LK / 1ZK		03.2123-3449.3 010808	ATE Ø 23,8
				01/07→; für Rechtslenker		24.2122-1981.3 011024	ATE Ø 22,2 ohne Bremsflüssigkeitsbehälter
1.8 TFSI quattro	118	07/08→08/12		für Linkslenker; +PR 1ZE / 1ZF / 1ZP / 1ZD / 1LJ / 1ZM		03.2122-2129.3 010799	ATE Ø 22,2
				für Linkslenker; +PR 1LK / 1ZK		03.2123-3449.3 010808	ATE Ø 23,8
1.9 TDI	77	05/03→05/10		06/03→; für Linkslenker; → 8P-6A094000; +PR 1ZE / 1ZF / 1ZP / 1ZD / 1LJ / 1ZM		03.2122-2129.3 010799	ATE Ø 22,2
				06/03→; für Linkslenker; → 8P-6B009600; +PR 1ZE / 1ZF / 1ZP / 1ZD / 1LJ / 1ZM		03.2122-2129.3 010799	ATE Ø 22,2
				8P-6B009601→; für Linkslenker; +PR 1ZE / 1ZF / 1ZP / 1ZD / 1LJ / 1ZM		03.2122-2129.3 010799	ATE Ø 22,2
				8P-6A094001→; für Linkslenker; +PR 1ZE / 1ZF / 1ZP / 1ZD / 1LJ / 1ZM		03.2122-2129.3 010799	ATE Ø 22,2
				06/03→; für Linkslenker; → 8P-6A094000; +PR 1LK		03.2123-3449.3 010808	ATE Ø 23,8
				06/03→; für Linkslenker; → 8P-6B009600; +PR 1LK		03.2123-3449.3 010808	ATE Ø 23,8
				8P-6A094001→; für Linkslenker; +PR 1LK / 1ZK		03.2123-3449.3 010808	ATE Ø 23,8
				8P-6B009601→; für Linkslenker; +PR 1LK / 1ZK		03.2123-3449.3 010808	ATE Ø 23,8
				06/03→; für Rechtslenker		24.2122-1981.3 011024	ATE Ø 22,2 ohne Bremsflüssigkeitsbehälter
2.0 TDI	120	06/06→06/08		8P-6A094001→; für Linkslenker; +PR 1ZE / 1ZF / 1ZP / 1ZD / 1LJ / 1ZM		03.2122-2129.3 010799	ATE Ø 22,2
				8P-6B009601→; für Linkslenker; +PR 1ZE / 1ZF / 1ZP / 1ZD / 1LJ / 1ZM		03.2122-2129.3 010799	ATE Ø 22,2
				für Linkslenker; → 8P-6B009600; +PR 1ZE / 1ZF / 1ZP / 1ZD / 1LJ / 1ZM		03.2122-2129.3 010799	ATE Ø 22,2
				für Linkslenker; → 8P-6A094000; +PR 1ZE / 1ZF / 1ZP / 1ZD / 1LJ / 1ZM		03.2122-2129.3 010799	ATE Ø 22,2
				8P-6A094001→; für Linkslenker; +PR 1LK / 1ZK		03.2123-3449.3 010808	ATE Ø 23,8
				für Linkslenker; → 8P-6B009600; +PR 1LK		03.2123-3449.3 010808	ATE Ø 23,8
				für Linkslenker; → 8P-6A094000; +PR 1LK		03.2123-3449.3 010808	ATE Ø 23,8
	für Rechtslenker		24.2122-1981.3 011024	ATE Ø 22,2 ohne Bremsflüssigkeitsbehälter			
2.0 TDI 2.0 TDI quattro	125	03/06→08/12		+PR 1ZE / 1ZF / 1ZP / 1ZD / 1LJ / 1ZM		03.2123-3449.3 010808	ATE Ø 23,8
	125	03/06→08/12		für Linkslenker; +PR 1LK / 1ZK		03.2123-3449.3 010808	ATE Ø 23,8
				für Rechtslenker		24.2122-1981.3 011024	ATE Ø 22,2 ohne Bremsflüssigkeitsbehälter
→							



AUDI - A3 (8P1) 05/03→12/13

Hauptbremszylinder

2.0 TFSI 2.0 TFSI quattro	147	09/04→08/12		8P-6B009601→; für Linkslenker; →	03.2122-2129.3	010799	ATE Ø 22,2
	147	09/04→08/12		8P-7-103000; +PR 1ZE / 1ZF / 1ZP / 1ZD / 1LJ / 1ZM			
				8P-6A094001→; für Linkslenker; →			
				8P-7-103000; +PR 1ZE / 1ZF / 1ZP / 1ZD / 1LJ / 1ZM			
				für Linkslenker; → 8P-6A094000; +PR 1ZE / 1ZF / 1ZP / 1ZD / 1LJ / 1ZM			
				für Linkslenker; → 8P-6B009600; +PR 1ZE / 1ZF / 1ZP / 1ZD / 1LJ / 1ZM			
				8P-6B009601→; für Linkslenker; →			
				8P-7-103000; +PR 1LK / 1ZK			
				8P-7-103001→; +PR 1ZE / 1ZF / 1ZP / 1ZD / 1LJ / 1ZM			
3.2 V6 quattro S3 quattro	184	07/03→05/09		für Linkslenker; - ESP	03.2122-2129.3	010799	ATE Ø 22,2
	195	11/06→08/12		für Linkslenker; + ESP			
				für Rechtslenker; - ESP			
S3 quattro	188	02/07→08/12		07/08→; für Linkslenker; - ESP	03.2122-2129.3	010799	ATE Ø 22,2
				07/08→; für Linkslenker; + ESP			
				07/08→; für Rechtslenker; - ESP			











Drucksensor, Bremskraftverstärker

1.2 TSI	77	04/10→08/12		für Linkslenker; +PR 1AS	03.0655-0101.2	370008	ATE
1.4 TFSI	92	09/07→08/12					
1.6	75	05/03→08/12					
1.6 E-Power	75	01/11→08/12					
1.6 FSI	85	08/03→09/07					
1.6 TDI	66 -	05/09→08/12					
	77						
1.8 TFSI quattro	118	07/08→08/12					
2.0 FSI	110	05/03→06/08					
2.0 TDI	100 -	05/03→08/12					
	125						
2.0 TDI 16V	103	05/03→08/12					
2.0 TDI 16V quattro	103	08/04→08/12					
2.0 TDI quattro	100 -	05/03→08/12					
	125						
2.0 TFSI	147	09/04→08/12					
2.0 TFSI quattro	147	09/04→08/12					
1.8 T	110	08/06→08/12		01/07→; +PR 1AS; für Linkslenker			
1.8 TFSI	118	11/06→08/12					
1.9 TDI	77	05/03→05/10		06/03→; für Linkslenker; +PR 1AS			

AUDI - A3 (8V1, 8VK) 04/12→10/20

Hauptbremszylinder

1.0 TFSI	85	07/16→12/17		für Linkslenker	03.4153-5403.3	010994	ATE Ø 23,8
1.2 TFSI	77 -	02/13→08/16					
	81				24.4123-1719.3	011017	TRW Ø 23,8 ohne Bremsflüssigkeitsbehälter
1.4 TFSI	90 -	04/12→08/16					
	103				24.4153-1522.3	011048	ATE Ø 23,8 ohne Bremsflüssigkeitsbehälter
1.4 TFSI	110	05/14→12/17					
1.5 TFSI	110	05/17→12/17					
1.6 TDI	77 -	10/12→10/20					
	85						
1.8 TFSI	132	04/12→08/16					
1.8 TFSI quattro	132	08/12→08/16					
2.0 TDI	81 -	04/12→10/20					
	135						
2.0 TDI quattro	110 -	10/12→12/17					
	135						
2.0 TFSI	140	05/16→12/17					
2.0 TFSI quattro	140	05/16→12/17					
S3 quattro	206 -	11/12→12/17					
	228						

	kw			 	! #		
AUDI - A3 Cabriolet (8P7) 04/08→05/13							
 Bremskraftverstärker							
1.2 TFSI 1.4 TFSI 1.6 1.6 TDI 1.8 TFSI 1.9 TDI 2.0 TDI	77 92 75 77 118 77 100 - 103	03/10→05/13 02/11→05/13 09/08→05/10 05/09→05/13 04/08→05/13 04/08→10/09 04/08→05/13		für Linkslenker; +PR 1ZE / 1ZF / 1LJ / 1ZA		03.7863-3232.4 300307	ATE Ø 10" pneumatisch
2.0 TFSI	147	04/08→05/13		für Linkslenker; +PR 1ZE / 1ZF / 1LJ		03.7863-3332.4 300308	ATE Ø 10" pneumatisch
 Hauptbremszylinder							
1.2 TFSI 1.4 TFSI 1.6 1.6 TDI 1.8 TFSI 1.9 TDI 2.0 TDI	77 92 75 77 118 77 100 - 103	03/10→05/13 02/11→05/13 09/08→05/10 05/09→05/13 04/08→05/13 04/08→10/09 04/08→05/13		für Linkslenker; +PR 1ZE / 1ZF / 1LJ / 1ZA		03.2122-2129.3 010799	ATE Ø 22,2
2.0 TFSI	147	04/08→05/13		für Linkslenker; +PR 1ZE / 1ZF / 1LJ / 1ZA		03.2123-3449.3 010808	ATE Ø 23,8
AUDI - A3 Cabriolet (8V7, 8VE) 10/13→10/20							
 Hauptbremszylinder							
1.4 TFSI 1.4 TSI 1.5 TFSI 1.6 TDI 1.8 TFSI 1.8 TFSI quattro 2.0 TDI 2.0 TDI quattro 2.0 TFSI 2.0 TFSI quattro 35 TFSI 40 TFSI 40 TFSI quattro S3 quattro	85 - 103 110 110 81 - 85 125 - 132 132 100 - 135 110 - 135 140 140 - 162 110 140 140 210 - 228	10/13→10/20 05/14→10/20 05/17→10/18 02/14→10/20 10/13→10/20 03/14→07/16 10/13→10/20 03/14→10/20 05/16→10/20 05/14→10/20 10/18→10/20 11/18→10/20 11/18→10/20 03/14→10/20		für Linkslenker		03.4153-5403.3 010994 24.4123-1719.3 011017 24.4153-1522.3 011048	ATE Ø 23,8 TRW Ø 23,8 ohne Bremsflüssigkeitsbehälter ATE Ø 23,8 ohne Bremsflüssigkeitsbehälter
AUDI - A3 Limousine (8VS, 8VM) 05/13→06/21							
 Hauptbremszylinder							
1.0 TFSI 1.2 TFSI 1.4 TFSI 1.4 TSI 1.5 TFSI 1.6 TDI 1.6 TDI quattro 1.8 TFSI 1.8 TFSI quattro 2.0 TDI 2.0 TDI quattro 2.0 TFSI 2.0 TFSI quattro 30 TDI 30 TFSI 35 TDI 35 TFSI 40 TDI quattro 40 TFSI 40 TFSI quattro RS3 quattro S3 quattro	85 77 - 81 90 - 103 110 110 77 - 85 81 125 - 132 132 81 - 135 110 - 135 140 - 162 140 85 85 110 110 135 140 140 294 206 - 228	07/16→10/20 10/13→08/16 05/13→10/20 05/14→10/20 05/17→10/18 09/13→10/20 05/15→08/16 05/13→10/20 11/13→08/16 05/13→10/20 10/13→10/20 11/15→10/20 05/16→10/20 07/18→10/20 07/18→10/20 07/18→10/20 10/18→10/20 07/18→07/19 07/18→10/20 07/18→10/20 04/17→10/20 10/13→10/20		für Linkslenker		03.4153-5403.3 010994 24.4123-1719.3 011017 24.4153-1522.3 011048	ATE Ø 23,8 TRW Ø 23,8 ohne Bremsflüssigkeitsbehälter ATE Ø 23,8 ohne Bremsflüssigkeitsbehälter







AUDI - A3 Sportback (8PA) 09/04→12/15

Bremskraftverstärker

1.2 TSI	77	04/10→03/13	für Linkslenker; +PR 1AC / 1AT	03.7863-3232.4	300307	ATE Ø 10" pneumatisch
1.4 TFSI	92	09/07→03/13				
1.6	75	09/04→03/13				
1.6 E-Power	75	01/11→03/13				
1.6 FSI	85	09/04→09/07				
1.6 TDI	66 - 77	05/09→03/13				
1.8 TFSI quattro	118	07/08→03/13				
1.9 TDI	77	09/04→05/10				
2.0 FSI	110	09/04→06/08				
2.0 TDI	100 - 125	09/04→03/13				
2.0 TDI 16V	103	09/04→03/13				
2.0 TDI 16V quattro	103	11/05→03/13				
2.0 TDI quattro	103 - 125	01/06→03/13				
2.0 TFSI	147	09/04→03/13				
2.0 TFSI quattro	147	09/04→03/13				
1.8 TFSI	118	11/06→03/13	01/07→; +PR 1AC / 1AT; für Linkslenker	03.7863-3232.4	300307	ATE Ø 10" pneumatisch
3.2 V6 quattro	184	09/04→05/09	für Linkslenker	03.7863-3332.4	300308	ATE Ø 10" pneumatisch
S3 quattro	188 - 195	06/08→03/13				

Hauptbremszylinder

1.2 TSI	77	04/10→03/13	für Linkslenker; +PR 1ZE / 1ZF / 1ZP / 1ZD / 1LJ / 1ZM	03.2122-2129.3	010799	ATE Ø 22,2			
			8P-6A094001→; für Linkslenker; +PR 1ZE / 1ZF / 1ZP / 1ZD / 1LJ / 1ZM	03.2122-2129.3	010799	ATE Ø 22,2			
			für Linkslenker; → 8P-6A094000; +PR 1ZE / 1ZF / 1ZP / 1ZD / 1LJ / 1ZM	03.2122-2129.3	010799	ATE Ø 22,2			
			für Linkslenker; → 8P-6B009600; +PR 1ZE / 1ZF / 1ZP / 1ZD / 1LJ / 1ZM	03.2122-2129.3	010799	ATE Ø 22,2			
			8P-6A094001→; für Linkslenker; +PR 1LK / 1ZK	03.2123-3449.3	010808	ATE Ø 23,8			
			für Linkslenker; +PR 1LK / 1ZK	03.2123-3449.3	010808	ATE Ø 23,8			
			für Linkslenker; → 8P-6B009600; +PR 1LK	03.2123-3449.3	010808	ATE Ø 23,8			
			für Linkslenker; → 8P-6A094000; +PR 1LK	03.2123-3449.3	010808	ATE Ø 23,8			
			für Rechtslenker	24.2122-1981.3	011024	ATE Ø 22,2 ohne Bremsflüssigkeitsbehälter			
1.4 TFSI	92	09/07→03/13	für Linkslenker; +PR 1ZE / 1ZF / 1ZP / 1ZD / 1LJ / 1ZM	03.2122-2129.3	010799	ATE Ø 22,2			
			für Linkslenker; +PR 1LK / 1ZK	03.2123-3449.3	010808	ATE Ø 23,8			
			für Rechtslenker	24.2122-1981.3	011024	ATE Ø 22,2 ohne Bremsflüssigkeitsbehälter			
1.6 1.6 E-Power 1.6 FSI 1.6 TDI	75 75 85 66 - 77	09/04→03/13 01/11→03/13 09/04→09/07 05/09→03/13	8P-6A094001→; für Linkslenker; +PR 1ZE / 1ZF / 1ZP / 1ZD / 1LJ / 1ZM	03.2122-2129.3	010799	ATE Ø 22,2			
			8P-6B009601→; für Linkslenker; +PR 1ZE / 1ZF / 1ZP / 1ZD / 1LJ / 1ZM	03.2122-2129.3	010799	ATE Ø 22,2			
			für Linkslenker; → 8P-6B009600; +PR 1ZE / 1ZF / 1ZP / 1ZD / 1LJ / 1ZM	03.2122-2129.3	010799	ATE Ø 22,2			
			für Linkslenker; → 8P-6A094000; +PR 1ZE / 1ZF / 1ZP / 1ZD / 1LJ / 1ZM	03.2122-2129.3	010799	ATE Ø 22,2			
			8P-6A094001→; für Linkslenker; +PR 1LK / 1ZK	03.2123-3449.3	010808	ATE Ø 23,8			
			für Linkslenker; → 8P-6B009600; +PR 1LK	03.2123-3449.3	010808	ATE Ø 23,8			
			für Linkslenker; → 8P-6A094000; +PR 1LK	03.2123-3449.3	010808	ATE Ø 23,8			
			für Rechtslenker	24.2122-1981.3	011024	ATE Ø 22,2 ohne Bremsflüssigkeitsbehälter			
			1.8 TFSI	118	11/06→03/13	01/07→; für Linkslenker; +PR 1ZE / 1ZF / 1ZP / 1ZD / 1LJ / 1ZM	03.2122-2129.3	010799	ATE Ø 22,2
						01/07→; für Linkslenker; +PR 1LK / 1ZK	03.2123-3449.3	010808	ATE Ø 23,8
						01/07→; für Rechtslenker	24.2122-1981.3	011024	ATE Ø 22,2 ohne Bremsflüssigkeitsbehälter
						für Linkslenker; +PR 1ZE / 1ZF / 1ZP / 1ZD / 1LJ / 1ZM	03.2122-2129.3	010799	ATE Ø 22,2
für Linkslenker; +PR 1LK / 1ZK	03.2123-3449.3	010808				ATE Ø 23,8			
für Rechtslenker	24.2122-1981.3	011024				ATE Ø 22,2 ohne Bremsflüssigkeitsbehälter			
1.8 TFSI quattro	118	07/08→03/13	für Linkslenker; +PR 1ZE / 1ZF / 1ZP / 1ZD / 1LJ / 1ZM	03.2122-2129.3	010799	ATE Ø 22,2			
			für Linkslenker; +PR 1LK / 1ZK	03.2123-3449.3	010808	ATE Ø 23,8			
2.0 TDI	104	01/10→03/13	8P-6A094001→; für Linkslenker; +PR 1ZE / 1ZF / 1ZP / 1ZD / 1LJ / 1ZM	03.2122-2129.3	010799	ATE Ø 22,2			
			→						

	kw					! #		
AUDI - A3 Sportback (8PA) 09/04→12/15								
Hauptbremszylinder								
2.0 TDI	104	01/10→03/13		8P-6A094001→; für Linkslenker; +PR 1LK / 1ZK		03.2123-3449.3	010808	ATE Ø 23,8
				für Rechtslenker		24.2122-1981.3	011024	ATE Ø 22,2 ohne Bremsflüssigkeitsbehälter
2.0 TDI	120	06/06→06/08		8P-6A094001→; für Linkslenker; +PR 1ZE / 1ZF / 1ZP / 1ZD / 1LJ / 1ZM		03.2122-2129.3	010799	ATE Ø 22,2
				8P-6B009601→; für Linkslenker; +PR 1ZE / 1ZF / 1ZP / 1ZD / 1LJ / 1ZM		03.2122-2129.3	010799	ATE Ø 22,2
				für Linkslenker; → 8P-6A094000; +PR 1ZE / 1ZF / 1ZP / 1ZD / 1LJ / 1ZM		03.2122-2129.3	010799	ATE Ø 22,2
				für Linkslenker; → 8P-6B009600; +PR 1ZE / 1ZF / 1ZP / 1ZD / 1LJ / 1ZM		03.2122-2129.3	010799	ATE Ø 22,2
				8P-6A094001→; für Linkslenker; +PR 1LK / 1ZK		03.2123-3449.3	010808	ATE Ø 23,8
				für Linkslenker; → 8P-6A094000; +PR 1LK		03.2123-3449.3	010808	ATE Ø 23,8
				für Linkslenker; → 8P-6B009600; +PR 1LK		03.2123-3449.3	010808	ATE Ø 23,8
				für Rechtslenker		24.2122-1981.3	011024	ATE Ø 22,2 ohne Bremsflüssigkeitsbehälter
2.0 TDI	125	03/06→03/13		+PR 1ZE / 1ZF / 1ZP / 1ZD / 1LJ / 1ZM		03.2123-3449.3	010808	ATE Ø 23,8
2.0 TDI quattro	125	03/06→03/13		für Linkslenker; +PR 1LK / 1ZK		03.2123-3449.3	010808	ATE Ø 23,8
				für Rechtslenker		24.2122-1981.3	011024	ATE Ø 22,2 ohne Bremsflüssigkeitsbehälter
2.0 TFSI	147	09/04→03/13		8P-6B009601→; für Linkslenker; → 8P-7-103000; +PR 1ZE / 1ZF / 1ZP / 1ZD / 1LJ / 1ZM		03.2122-2129.3	010799	ATE Ø 22,2
2.0 TFSI quattro	147	09/04→03/13		8P-6A094001→; für Linkslenker; → 8P-7-103000; +PR 1ZE / 1ZF / 1ZP / 1ZD / 1LJ / 1ZM		03.2122-2129.3	010799	ATE Ø 22,2
				für Linkslenker; → 8P-6B009600; +PR 1ZE / 1ZF / 1ZP / 1ZD / 1LJ / 1ZM		03.2122-2129.3	010799	ATE Ø 22,2
				für Linkslenker; → 8P-6A094000; +PR 1ZE / 1ZF / 1ZP / 1ZD / 1LJ / 1ZM		03.2122-2129.3	010799	ATE Ø 22,2
				8P-6B009601→; für Linkslenker; → 8P-7-103000; +PR 1LK / 1ZK		03.2123-3449.3	010808	ATE Ø 23,8
				8P-7-103001→; +PR 1ZE / 1ZF / 1ZP / 1ZD / 1LJ / 1ZM		03.2123-3449.3	010808	ATE Ø 23,8
				8P-6A094001→; für Linkslenker; → 8P-7-103000; +PR 1LK / 1ZK		03.2123-3449.3	010808	ATE Ø 23,8
				für Linkslenker; → 8P-6B009600; +PR 1LK		03.2123-3449.3	010808	ATE Ø 23,8
				für Linkslenker; → 8P-6A094000; +PR 1LK		03.2123-3449.3	010808	ATE Ø 23,8
				für Rechtslenker		24.2122-1981.3	011024	ATE Ø 22,2 ohne Bremsflüssigkeitsbehälter
3.2 V6 quattro	184	09/04→05/09		für Linkslenker; - ESP		03.2122-2129.3	010799	ATE Ø 22,2
S3 quattro	188 - 195	06/08→03/13		für Linkslenker; + ESP		03.2123-3449.3	010808	ATE Ø 23,8
				für Rechtslenker; - ESP		24.2122-1981.3	011024	ATE Ø 22,2 ohne Bremsflüssigkeitsbehälter
RS3 quattro	250	01/11→12/12		04/11→; für Linkslenker		03.2125-5112.3	010966	ATE Ø 25,4
Drucksensor, Bremskraftverstärker								
1.2 TSI	77	04/10→03/13		für Linkslenker; +PR 1AS		03.0655-0101.2	370008	ATE
1.4 TFSI	92	09/07→03/13						
1.6	75	09/04→03/13						
1.6 E-Power	75	01/11→03/13						
1.6 FSI	85	09/04→09/07						
1.6 TDI	66 - 77	05/09→03/13						
1.8 TFSI quattro	118	07/08→03/13						
1.9 TDI	77	09/04→05/10						
2.0 FSI	110	09/04→06/08						
2.0 TDI	100 - 125	09/04→03/13						
2.0 TDI 16V	103	09/04→03/13						
2.0 TDI 16V quattro	103	11/05→03/13						
2.0 TDI quattro	103 - 125	01/06→03/13						
2.0 TFSI	147	09/04→03/13						
2.0 TFSI quattro	147	09/04→03/13						
1.8 TFSI	118	11/06→03/13		01/07→; +PR 1AS; für Linkslenker		03.0655-0101.2	370008	ATE



AUDI - A3 Sportback (8VA, 8VF) 09/12→10/20

Hauptbremszylinder

1.0 TFSI	85	07/16→10/20		für Linkslenker	03.4153-5403.3	010994	ATE Ø 23,8
1.2 TFSI	77 - 81	05/13→08/16			24.4123-1719.3	011017	TRW Ø 23,8 ohne Bremsflüssigkeitsbehälter
1.4 TFSI	90 - 103	09/12→10/20			24.4153-1522.3	011048	ATE Ø 23,8 ohne Bremsflüssigkeitsbehälter
1.4 TFSI e-tron	150	05/14→10/20					
1.4 TFSI g-tron	81	11/13→10/20					
1.4 TSI	110	05/14→10/20					
1.5 TFSI	110	05/17→10/18					
1.6 TDI	77 - 85	10/12→10/20					
1.6 TDI quattro	81	05/15→08/16					
1.8 TFSI	132	09/12→08/16					
1.8 TFSI quattro	132	05/13→08/16					
2.0 TDI	81 - 135	09/12→10/20					
2.0 TDI quattro	110 - 135	02/13→10/20					
2.0 TFSI	140	05/16→10/20					
2.0 TFSI quattro	140	05/16→10/20					
30 g-tron	96	11/18→10/20					
30 TDI	85	07/18→10/20					
30 TFSI	85	07/18→10/20					
35 TDI	110	07/18→10/20					
35 TFSI	110	10/18→10/20					
40 e-tron	150	07/18→10/20					
40 TDI quattro	135	07/18→10/20					
40 TFSI	140	07/18→10/20					
40 TFSI quattro	140	07/18→10/20					
RS3 quattro	270 - 294	03/15→10/20					
S3 quattro	206 - 228	11/12→10/20					

AUDI - A4 Allroad B8 (8KH) 04/09→05/16

Bremskraftverstärker

2.0 TDI quattro	100 - 125	04/09→05/16			03.7858-4632.4	300273	ATE Ø 9 / 8" pneumatisch
2.0 TFSI quattro	155	04/09→05/16					
3.0 TDI quattro	176	04/09→01/12					
2.0 TDI quattro	110 - 140	05/13→05/16		+PR GP0 / GP1	03.7858-4632.4	300273	ATE Ø 9 / 8" pneumatisch
2.0 TFSI quattro	162 - 165	05/13→05/16					
3.0 TDI quattro	180	01/12→05/16					
2.0 TDI quattro	130	11/11→05/16		01/12→; +PR GP0 / GP1	03.7858-4632.4	300273	ATE Ø 9 / 8" pneumatisch

Hauptbremszylinder

2.0 TDI quattro	100 - 125	04/09→05/16			03.2125-0493.3	010940	ATE Ø 25,4
2.0 TFSI quattro	155	04/09→05/16			24.2125-1739.3	010948	TRW Ø 25,4
3.0 TDI quattro	176	04/09→01/12					
2.0 TDI quattro	110 - 140	05/13→05/16		+PR GP0 / GP1	03.2125-0493.3	010940	ATE Ø 25,4
2.0 TFSI quattro	162 - 165	05/13→05/16			24.2125-1739.3	010948	TRW Ø 25,4
3.0 TDI quattro	180	01/12→05/16					
2.0 TDI quattro	130	11/11→05/16		01/12→; +PR GP0 / GP1	03.2125-0493.3	010940	ATE Ø 25,4
					24.2125-1739.3	010948	TRW Ø 25,4

AUDI - A4 B5 (8D2) 11/94→12/01

Hauptbremszylinder

1.6	74	11/94→10/00		→ 01/99	24.2123-1717.3	010521	Ø 23,8
1.8	85 - 92	11/94→11/00		02/99→; - ESP; für Linkslenker	24.2125-1712.3	010622	Ø 25,4
1.8 T	132	12/97→11/00		02/99→; + ESP; für Linkslenker	24.2125-1713.3	010623	Ø 25,4
1.9 TDI	66	01/95→11/00					
2.4	120	08/97→11/00					
2.5 TDI	110	09/97→11/00					
2.6	110	01/95→11/00					
2.8	142	10/96→11/00					
1.6	75	07/00→11/00		- ESP; für Linkslenker	24.2125-1712.3	010622	Ø 25,4
1.9 TDI	85	03/00→11/00		+ ESP; für Linkslenker	24.2125-1713.3	010623	Ø 25,4
1.9 TDI quattro	85	03/00→11/00					
2.8	140	09/99→10/00					
2.8 quattro	140	09/99→10/00					
1.8 quattro	85 - 92	01/95→11/00		→ 01/99; - ESP	24.2123-1717.3	010521	Ø 23,8
1.8 T quattro	132	12/97→11/00		→ 01/99; + ESP	24.2123-1730.3	010620	Ø 23,8

AUDI - A4 B5 (8D2) 11/94→12/01











Hauptbremszylinder













1.9 TDI quattro	81	09/96→11/00	02/99→; - ESP; für Linkslenker	24.2125-1712.3	010622	Ø 25,4
2.4 quattro	120	08/97→11/00	02/99→; + ESP; für Linkslenker	24.2125-1713.3	010623	Ø 25,4
2.6 quattro	110	01/95→11/00				
1.8 T	110	01/95→11/00	05/95→ 01/99	24.2123-1717.3	010521	Ø 23,8
			02/99→; - ESP; für Linkslenker	24.2125-1712.3	010622	Ø 25,4
			02/99→; + ESP; für Linkslenker	24.2125-1713.3	010623	Ø 25,4
1.8 T quattro	110	01/95→11/00	02/95→ 01/99; - ESP	24.2123-1717.3	010521	Ø 23,8
			02/95→ 01/99; + ESP	24.2123-1730.3	010620	Ø 23,8
			02/99→; - ESP; für Linkslenker	24.2125-1712.3	010622	Ø 25,4
			02/99→; + ESP; für Linkslenker	24.2125-1713.3	010623	Ø 25,4
1.9 TDI	55	12/95→11/00	03/96→ 01/99	24.2123-1717.3	010521	Ø 23,8
			02/99→; - ESP; für Linkslenker	24.2125-1712.3	010622	Ø 25,4
			02/99→; + ESP; für Linkslenker	24.2125-1713.3	010623	Ø 25,4
1.9 TDI	81	10/95→11/00	02/96→ 01/99	24.2123-1717.3	010521	Ø 23,8
			02/99→; - ESP; für Linkslenker	24.2125-1712.3	010622	Ø 25,4
			02/99→; + ESP; für Linkslenker	24.2125-1713.3	010623	Ø 25,4
2.4	121	03/97→11/00	→ 07/97	24.2123-1717.3	010521	Ø 23,8
			08/97→ 01/99	24.2123-1717.3	010521	Ø 23,8
			02/99→; - ESP; für Linkslenker	24.2125-1712.3	010622	Ø 25,4
			02/99→; + ESP; für Linkslenker	24.2125-1713.3	010623	Ø 25,4
2.4 quattro	121	03/97→11/00	08/97→ 01/99; - ESP	24.2123-1717.3	010521	Ø 23,8
			08/97→ 01/99; + ESP	24.2123-1730.3	010620	Ø 23,8
			02/99→; - ESP; für Linkslenker	24.2125-1712.3	010622	Ø 25,4
			02/99→; + ESP; für Linkslenker	24.2125-1713.3	010623	Ø 25,4
2.5 TDI quattro	110	09/97→11/00	11/97→ 01/99	24.2123-1717.3	010521	Ø 23,8
			11/97→ 01/99; + ESP	24.2123-1730.3	010620	Ø 23,8
			02/99→; - ESP; für Linkslenker	24.2125-1712.3	010622	Ø 25,4
			02/99→; + ESP; für Linkslenker	24.2125-1713.3	010623	Ø 25,4
2.8 quattro	142	10/96→08/01	→ 01/99; - ESP	24.2123-1717.3	010521	Ø 23,8
			→ 01/99; + ESP	24.2123-1730.3	010620	Ø 23,8
			02/99→ 04/01; - ESP; für Linkslenker	24.2125-1712.3	010622	Ø 25,4
			02/99→ 04/01; + ESP; für Linkslenker	24.2125-1713.3	010623	Ø 25,4
S4 quattro	195	09/97→09/01	10/97→ 01/99; - ESP	24.2123-1717.3	010521	Ø 23,8
			10/97→ 01/99; + ESP	24.2123-1730.3	010620	Ø 23,8
			02/99→ 04/01; - ESP; für Linkslenker	24.2125-1712.3	010622	Ø 25,4
			02/99→ 04/01; + ESP; für Linkslenker	24.2125-1713.3	010623	Ø 25,4











AUDI - A4 B5 Avant (8D5) 11/94→12/02











Hauptbremszylinder













1.6	74	11/94→09/01	→ 01/99	24.2123-1717.3	010521	Ø 23,8
1.8	85 - 92	07/95→09/01	02/99→ 04/01; - ESP; für Linkslenker	24.2125-1712.3	010622	Ø 25,4
			02/99→ 04/01; + ESP; für Linkslenker	24.2125-1713.3	010623	Ø 25,4
1.8 T	110 - 132	03/96→09/01				
1.9 TDI	55 - 81	02/96→09/01				
2.4	120	08/97→09/01				
2.5 TDI	110	09/97→09/01				
2.6	110	02/96→09/01				
2.8	142	10/96→09/01				
1.6	75 - 85	07/00→09/01	→ 04/01; - ESP; für Linkslenker	24.2125-1712.3	010622	Ø 25,4
			→ 04/01; + ESP; für Linkslenker	24.2125-1713.3	010623	Ø 25,4
1.9 TDI quattro	85	03/00→09/01				
1.8 quattro	85 - 92	07/95→09/01	→ 01/99; - ESP	24.2123-1717.3	010521	Ø 23,8
			→ 01/99; + ESP	24.2123-1730.3	010620	Ø 23,8
1.8 T quattro	110 - 132	01/96→09/01	02/99→ 04/01; - ESP; für Linkslenker	24.2125-1712.3	010622	Ø 25,4
			02/99→ 04/01; + ESP; für Linkslenker	24.2125-1713.3	010623	Ø 25,4
1.9 TDI quattro	81	09/96→09/01				
2.4 quattro	120	08/97→09/01				
2.6 quattro	110	01/96→09/01				
2.8 quattro	142	10/96→09/01				
1.9 Hybrid	66	03/98→06/00	→ 01/99	24.2123-1717.3	010521	Ø 23,8
			02/99→; - ESP; für Linkslenker	24.2125-1712.3	010622	Ø 25,4
			02/99→; + ESP; für Linkslenker	24.2125-1713.3	010623	Ø 25,4
2.4	121	03/97→09/01	08/97→ 01/99	24.2123-1717.3	010521	Ø 23,8
			02/99→ 04/01; - ESP; für Linkslenker	24.2125-1712.3	010622	Ø 25,4
			02/99→ 04/01; + ESP; für Linkslenker	24.2125-1713.3	010623	Ø 25,4
→						













	kw					! #		
AUDI - A4 B5 Avant (8D5) 11/94→12/02								
 Hauptbremszylinder								
2.4 quattro	121	03/97→09/01		08/97→ 01/99; - ESP		24.2123-1717.3 010521	Ø 23,8	
				08/97→ 01/99; + ESP		24.2123-1730.3 010620	Ø 23,8	
				02/99→ 04/01; - ESP; für Linkslenker		24.2125-1712.3 010622	Ø 25,4	
				02/99→ 04/01; + ESP; für Linkslenker		24.2125-1713.3 010623	Ø 25,4	
2.5 TDI quattro	110	09/97→09/01		11/97→ 01/99		24.2123-1717.3 010521	Ø 23,8	
				11/97→ 01/99; + ESP		24.2123-1730.3 010620	Ø 23,8	
				02/99→ 04/01; - ESP; für Linkslenker		24.2125-1712.3 010622	Ø 25,4	
				02/99→ 04/01; + ESP; für Linkslenker		24.2125-1713.3 010623	Ø 25,4	
2.8 2.8 quattro	140	03/99→09/00		- ESP; für Linkslenker		24.2125-1712.3 010622	Ø 25,4	
	140	03/99→09/00		+ ESP; für Linkslenker		24.2125-1713.3 010623	Ø 25,4	
RS4 quattro	280	05/00→09/01		06/00→ 04/01; für Linkslenker		24.2125-1713.3 010623	Ø 25,4	
S4 quattro	195	09/97→09/01		10/97→ 01/99; - ESP		24.2123-1717.3 010521	Ø 23,8	
				10/97→ 01/99; + ESP		24.2123-1730.3 010620	Ø 23,8	
				02/99→ 04/01; - ESP; für Linkslenker		24.2125-1712.3 010622	Ø 25,4	
				02/99→ 04/01; + ESP; für Linkslenker		24.2125-1713.3 010623	Ø 25,4	
AUDI - A4 B6 (8E2) 11/00→12/05								
 Bremskraftverstärker								
1.6 1.8 T 1.8 T quattro 1.9 TDI 1.9 TDI quattro 2.0 2.0 FSI 2.4 2.5 TDI 2.5 TDI quattro 3.0 3.0 quattro	75	11/00→12/04		8E-3-235001→		03.7858-4502.4 300202	ATE Ø 9 / 8" pneumatisch	
	110 -	11/00→12/04						
	140							
	110 -	11/00→12/04						
	140							
	74 -	11/00→12/04						
	96							
	96	11/01→12/04						
	96	11/00→12/04						
	110	07/02→12/04						
	120 -	09/01→12/04						
	125							
	114 -	08/01→12/04						
	120							
	132	11/00→12/04						
160 -	11/00→12/04							
162								
160 -	11/00→12/04							
162								
1.9 TDI	85	06/04→12/04				03.7858-4502.4 300202	ATE Ø 9 / 8" pneumatisch	
 Hauptbremszylinder								
1.6 1.8 T 1.8 T quattro 1.9 TDI 2.0 2.5 TDI quattro 3.0 3.0 quattro	75	11/00→12/04		12/00→		03.2125-0373.3 010810	ATE Ø 25,4	
	110	11/00→07/02						
	110	11/00→07/02						
	96	11/00→12/04						
	96	11/00→12/04						
	132	11/00→12/04						
	162	11/00→12/04						
162	11/00→12/04							
1.8 T 1.8 T quattro 1.9 TDI 1.9 TDI quattro 2.0 FSI 2.4 2.5 TDI 3.0 3.0 quattro S4 quattro	120 -	07/01→12/04				03.2125-0373.3 010810	ATE Ø 25,4	
	140							
	120 -	07/01→12/04						
	140							
	74 -	05/01→12/04						
	85							
	96	11/01→12/04						
	110	07/02→12/04						
	120 -	09/01→12/04						
	125							
	114 -	08/01→12/04						
	120							
	160	04/01→12/04						
	160	04/01→12/04						
	253	03/03→12/04						
						24.2126-1705.3 010999	TRW Ø 27	
AUDI - A4 B6 Avant (8E5) 02/00→12/05								
 Bremskraftverstärker								
1.6 1.8 T 1.8 T quattro 1.9 TDI 1.9 TDI quattro →	75	09/01→12/04		8E-3-235001→		03.7858-4502.4 300202	ATE Ø 9 / 8" pneumatisch	
	110 -	09/01→12/04						
	140							
	110 -	09/01→12/04						
	140							
	74 -	09/01→12/04						
96								
96	11/01→12/04							













	kw			 	! #		
AUDI - A4 B6 Avant (8E5) 02/00→12/05							
 Bremskraftverstärker							
2.0 2.0 FSI 2.4	96 110 120	09/01→12/04 07/02→12/04 09/01→12/04		8E-3-235001→		03.7858-4502.4 300202	ATE Ø 9 / 8" pneumatisch
2.5 TDI 2.5 TDI quattro 3.0 3.0 quattro	125 114 - 120 132 160 - 162 160 - 162	09/01→12/04 09/01→12/04 04/01→12/04 04/01→12/04					
1.9 TDI	85	06/04→12/04				03.7858-4502.4 300202	ATE Ø 9 / 8" pneumatisch
 Hauptbremszylinder							
1.6 1.8 T 1.8 T quattro 1.9 TDI 1.9 TDI quattro 2.0 2.0 FSI 2.4 2.5 TDI 2.5 TDI quattro 3.0 3.0 quattro S4 quattro	75 110 - 140 110 - 140 74 - 96 96 96 110 120 - 125 114 - 120 132 160 - 162 160 - 162 253	09/01→12/04 09/01→12/04 09/01→12/04 09/01→12/04 11/01→12/04 09/01→12/04 07/02→12/04 09/01→12/04 09/01→12/04 04/01→12/04 04/01→12/04 03/03→12/04				03.2125-0373.3 010810 24.2125-1720.3 010688	ATE Ø 25,4 TRW Ø 25,4
						24.2126-1705.3 010999	TRW Ø 27
AUDI - A4 B6 Cabriolet (8H7) 01/02→12/09							
 Bremskraftverstärker							
1.8 T 2.4 2.5 TDI 3.0 1.8 T quattro 2.0 3.0 quattro 3.0	120 - 125 120 - 125 120 162	07/02→12/05 04/02→12/05 08/02→12/05 04/02→12/05 05/03→12/05 09/04→12/05 05/03→12/05 04/02→12/05		8H-3-017415→		03.7858-4502.4 300202	ATE Ø 9 / 8" pneumatisch
						03.7858-4502.4 300202	ATE Ø 9 / 8" pneumatisch
				8E-3-235001→		03.7858-4502.4 300202	ATE Ø 9 / 8" pneumatisch
 Hauptbremszylinder							
1.8 T 2.4 2.5 TDI 3.0 1.8 T quattro 2.0 3.0 quattro 3.0 S4 quattro	120 - 125 120 - 125 120 162 120 96 162 160 253	07/02→12/05 04/02→12/05 08/02→12/05 04/02→12/05 05/03→12/05 09/04→12/05 05/03→12/05 04/02→12/05 03/04→12/05		8H-7-022001→ 8H-3-017415→ 8H-7-022000		03.2125-0373.3 010810 03.2125-0373.3 010810 24.2125-1720.3 010688	ATE Ø 25,4 ATE Ø 25,4 TRW Ø 25,4
				8H-7-022001→		03.2125-0373.3 010810	ATE Ø 25,4
				→ 8H-7-022000		03.2125-0373.3 010810	ATE Ø 25,4
						24.2125-1720.3 010688	TRW Ø 25,4
						03.2125-0373.3 010810	ATE Ø 25,4
						24.2125-1720.3 010688	TRW Ø 25,4
						24.2126-1705.3 010999	TRW Ø 27
AUDI - A4 B7 (8EC) 11/04→06/08							
 Bremskraftverstärker							
1.6 1.8 T 1.8 T quattro 2.0 2.5 TDI 3.0 3.0 quattro 1.9 TDI 2.0 TDI 2.0 TDI quattro	75 120 120 96 120 160 160 85 120 - 125 103 - 125	11/04→06/08 11/04→06/08 11/04→06/08 11/04→06/08 11/04→05/06 11/04→05/06 11/04→07/06 11/04→06/08 06/06→06/08 01/06→06/08		8E-3-235001→		03.7858-4502.4 300202	ATE Ø 9 / 8" pneumatisch
						03.7858-4502.4 300202	ATE Ø 9 / 8" pneumatisch
→							











	kw			 	! #		
AUDI - A4 B7 (8EC) 11/04→06/08							
 Bremskraftverstärker							
2.0 TFSI	125 - 162	11/04→06/08				03.7858-4502.4 300202	ATE Ø 9 / 8" pneumatisch
2.7 TDI	120 - 132	11/05→06/08					
3.0 TDI quattro	171	01/06→06/08					
3.2 FSI	188	01/05→06/08					
2.0 TDI	89 - 103	11/04→06/08		8E-5-400001→		03.7858-4502.4 300202	ATE Ø 9 / 8" pneumatisch
2.0 TDI 16V	103	11/04→06/08					
2.0 TFSI quattro	147 - 162	11/04→06/08					
3.0 TDI quattro	150	11/04→06/08					
3.2 FSI quattro	188	01/05→06/08					
2.0 TDI	93	11/05→11/06		06/06→		03.7858-4502.4 300202	ATE Ø 9 / 8" pneumatisch
 Hauptbremszylinder							
1.6	75	11/04→06/08				03.2125-0373.3 010810	ATE Ø 25,4
1.8 T	120	11/04→06/08				24.2125-1720.3 010688	TRW Ø 25,4
1.8 T quattro	120	11/04→06/08					
1.9 TDI	85	11/04→06/08					
2.0	96	11/04→06/08					
2.0 TDI	89 - 125	11/04→06/08					
2.0 TDI 16V	103	11/04→06/08					
2.0 TDI quattro	103 - 125	01/06→06/08					
2.0 TFSI	125 - 162	06/05→06/08					
2.0 TFSI quattro	147 - 162	11/04→06/08					
2.5 TDI	120	11/04→05/06					
2.7 TDI	120 - 132	11/05→06/08					
3.0	160	11/04→05/06					
3.0 quattro	160	11/04→07/06					
3.0 TDI quattro	150 - 171	11/04→06/08					
3.2 FSI	188	01/05→06/08					
3.2 FSI quattro	188	01/05→06/08					
2.0 TDI	93	11/05→11/06		06/06→		03.2125-0373.3 010810 24.2125-1720.3 010688	ATE Ø 25,4 TRW Ø 25,4
2.0 TFSI	147	11/04→06/08		12/04→		03.2125-0373.3 010810 24.2125-1720.3 010688	ATE Ø 25,4 TRW Ø 25,4
RS4 quattro	309	09/05→06/08		11/05→		24.2126-1705.3 010999	TRW Ø 27
S4 quattro	253	11/04→06/08				24.2126-1705.3 010999	TRW Ø 27
AUDI - A4 B7 Avant (8ED) 11/04→06/08							
 Bremskraftverstärker							
1.6	75	11/04→06/08		8E-3-235001→		03.7858-4502.4 300202	ATE Ø 9 / 8" pneumatisch
1.8 T	120	11/04→06/08					
1.8 T quattro	120	11/04→06/08					
2.0	96	11/04→06/08					
2.5 TDI	120	11/04→05/06					
3.0	160	11/04→05/06					
3.0 quattro	160	11/04→07/06					
1.9 TDI	85	11/04→06/08				03.7858-4502.4 300202	ATE Ø 9 / 8" pneumatisch
2.0 TDI	120 - 125	06/06→06/08					
2.0 TDI quattro	103 - 125	01/06→06/08					
2.0 TFSI	125 - 162	11/04→06/08					
2.7 TDi	120	11/05→03/08					
2.7 TDI	132	01/06→06/08					
3.0 TDI quattro	171	01/06→06/08					
3.2 FSI	188	01/05→06/08					
2.0 TDI	89 - 103	11/04→06/08		8E-5-400001→		03.7858-4502.4 300202	ATE Ø 9 / 8" pneumatisch
2.0 TDI 16V	103	11/04→06/08					
2.0 TFSI quattro	147 - 162	11/04→06/08					
3.0 TDI quattro	150	11/04→06/08					
3.2 FSI quattro	188	01/05→06/08					
2.0 TDI	93	11/05→11/06		06/06→		03.7858-4502.4 300202	ATE Ø 9 / 8" pneumatisch
 Hauptbremszylinder							
1.6	75	11/04→06/08				03.2125-0373.3 010810	ATE Ø 25,4
1.8 T	120	11/04→06/08					
→							

	kw			 	! #		
AUDI - A4 B7 Avant (8ED) 11/04→06/08							
 Hauptbremszylinder							
1.8 T quattro	120	11/04→06/08				24.2125-1720.3 010688	TRW Ø 25,4
1.9 TDI	85	11/04→06/08					
2.0	96	11/04→06/08					
2.0 TDI	89 - 125	11/04→06/08					
2.0 TDI 16V	103	11/04→06/08					
2.0 TDI quattro	103 - 125	01/06→06/08					
2.0 TFSI	125 - 162	06/05→06/08					
2.0 TFSI quattro	147 - 162	11/04→06/08					
2.5 TDI	120	11/04→05/06					
2.7 TDi	120	11/05→03/08					
2.7 TDI	132	01/06→06/08					
3.0	160	11/04→05/06					
3.0 quattro	160	11/04→07/06					
3.0 TDI quattro	150 - 171	11/04→06/08					
3.2 FSI	188	01/05→06/08					
3.2 FSI quattro	188	01/05→06/08					
2.0 TDI	93	11/05→11/06		06/06→		03.2125-0373.3 010810	ATE Ø 25,4
						24.2125-1720.3 010688	TRW Ø 25,4
2.0 TFSI	147	11/04→06/08		12/04→		03.2125-0373.3 010810	ATE Ø 25,4
						24.2125-1720.3 010688	TRW Ø 25,4
RS4 quattro	309	09/05→06/08		11/05→		24.2126-1705.3 010999	TRW Ø 27
S4 quattro	253	11/04→06/08				24.2126-1705.3 010999	TRW Ø 27
AUDI - A4 B7 Cabriolet (8HE) 01/02→12/09							
 Bremskraftverstärker							
1.8 T	120	01/06→03/09		8E-3-235001→		03.7858-4502.4 300202	ATE Ø 9 / 8" pneumatisch
2.0 TDI	100 - 103	01/06→03/09		→ 11/08		03.7858-4502.4 300202	ATE Ø 9 / 8" pneumatisch
2.0 TFSI 16V	147	01/06→03/09					
2.7 TDI	132	06/06→03/09					
3.0 TDI quattro	150 - 171	01/06→03/09					
3.2 FSI	188	01/06→03/09					
3.2 FSI quattro	188	01/06→03/09					
 Hauptbremszylinder							
1.8 T	120	01/06→03/09				03.2125-0373.3 010810	ATE Ø 25,4
						24.2125-1720.3 010688	TRW Ø 25,4
2.0 TDI	100 - 103	01/06→03/09		→ 8H-7-022000		03.2125-0373.3 010810	ATE Ø 25,4
2.0 TFSI 16V	147	01/06→03/09		8H-7-022001→; → 11/08		03.2125-0373.3 010810	ATE Ø 25,4
2.7 TDI	132	06/06→03/09		→ 11/08		24.2125-1720.3 010688	TRW Ø 25,4
3.0 TDI quattro	150 - 171	01/06→03/09					
3.2 FSI	188	01/06→03/09					
3.2 FSI quattro	188	01/06→03/09					
RS4 quattro	309	02/06→12/08		→ 11/08		24.2126-1705.3 010999	TRW Ø 27
S4 quattro	253	11/05→03/09				24.2126-1705.3 010999	TRW Ø 27
AUDI - A4 B8 (8K2) 08/07→09/16							
 Bremskraftverstärker							
1.8 TFSI	88 - 118	11/07→12/15				03.7858-4632.4 300273	ATE Ø 9 / 8" pneumatisch
1.8 TFSI quattro	118	09/08→03/12					
2.0 TDI	88 - 125	11/07→12/15					
2.0 TDI quattro	105 - 125	01/08→12/15					
2.0 TFSI	132 - 155	06/08→12/15					
2.0 TFSI flexible fuel	132	11/09→12/15					
2.0 TFSI flexible fuel quattro	132	11/09→12/15					
2.0 TFSI quattro	132 - 155	06/08→12/15					
2.7 TDI	120 - 140	11/07→03/12					
3.0 TDI quattro	155 - 176	11/07→03/12					
3.2 FSI	195	09/08→03/12					
3.2 FSI quattro	195	11/07→03/12					
→							

	kW			 	! #		
AUDI - A4 B8 (8K2) 08/07→09/16							
 Bremskraftverstärker							
S4 quattro	245	11/08→12/15				03.7858-4632.4 300273	ATE Ø 9 / 8" pneumatisch
 Hauptbremszylinder							
1.8 TFSI	88 - 118	11/07→12/15				03.2125-0493.3 010940	ATE Ø 25,4
1.8 TFSI quattro	118	09/08→03/12				24.2125-1739.3 010948	TRW Ø 25,4
2.0 TDI	88 - 125	11/07→12/15					
2.0 TDI quattro	105 - 125	01/08→12/15					
2.0 TFSI	132 - 155	06/08→12/15					
2.0 TFSI flexible fuel	132	11/09→12/15					
2.0 TFSI flexible fuel quattro	132	11/09→12/15					
2.0 TFSI quattro	132 - 155	06/08→12/15					
2.7 TDI	120 - 140	11/07→03/12					
3.0 TDI quattro	155 - 176	11/07→03/12					
3.2 FSI	195	09/08→03/12					
3.2 FSI quattro	195	11/07→03/12					
S4 quattro	245	11/08→12/15					
AUDI - A4 B8 Avant (8K5) 11/07→12/15							
 Bremskraftverstärker							
1.8 TFSI	88	04/08→12/15				03.7858-4632.4 300273	ATE Ø 9 / 8" pneumatisch
1.8 TFSI quattro	118	09/08→03/12					
2.0 TDI	88 - 125	04/08→12/15					
2.0 TDI quattro	105 - 125	04/08→12/15					
2.0 TFSI	132 - 155	06/08→12/15					
2.0 TFSI flexible fuel	132	11/09→12/15					
2.0 TFSI flexible fuel quattro	132	11/09→12/15					
2.0 TFSI quattro	155	06/08→12/15					
2.7 TDI	120	06/08→03/12					
3.0 TDI quattro	155 - 176	04/08→03/12					
3.2 FSI	195	09/08→03/12					
3.2 FSI quattro	195	04/08→03/12					
S4 quattro	245	11/08→12/15					
1.8 TFSI	118	11/07→03/12		04/08→		03.7858-4632.4 300273	ATE Ø 9 / 8" pneumatisch
2.7 TDI	140	04/08→03/12		06/08→		03.7858-4632.4 300273	ATE Ø 9 / 8" pneumatisch
 Hauptbremszylinder							
1.8 TFSI	88	04/08→12/15				03.2125-0493.3 010940	ATE Ø 25,4
1.8 TFSI quattro	118	09/08→03/12				24.2125-1739.3 010948	TRW Ø 25,4
2.0 TDI	88 - 125	04/08→12/15					
2.0 TDI quattro	105 - 125	04/08→12/15					
2.0 TFSI	132 - 155	06/08→12/15					
2.0 TFSI flexible fuel	132	11/09→12/15					
2.0 TFSI flexible fuel quattro	132	11/09→12/15					
2.0 TFSI quattro	155	06/08→12/15					
2.7 TDI	120	06/08→03/12					
3.0 TDI quattro	155 - 176	04/08→03/12					
3.2 FSI	195	09/08→03/12					
3.2 FSI quattro	195	04/08→03/12					
S4 quattro	245	11/08→12/15					
1.8 TFSI	118	11/07→03/12		04/08→		03.2125-0493.3 010940	ATE Ø 25,4
						24.2125-1739.3 010948	TRW Ø 25,4
2.7 TDI	140	04/08→03/12		06/08→		03.2125-0493.3 010940	ATE Ø 25,4
						24.2125-1739.3 010948	TRW Ø 25,4
AUDI - A5 (8T3) 06/07→01/17							
 Bremskraftverstärker							
1.8 TFSI	118 - 125	10/07→01/17				03.7858-4632.4 300273	ATE Ø 9 / 8" pneumatisch
→							

	kw			 	! #		
AUDI - A5 (8T3) 06/07→01/17							
 Bremskraftverstärker							
2.0 TDI	125 - 130	08/08→01/17				03.7858-4632.4 300273	ATE Ø 9 / 8" pneumatisch
2.0 TDI quattro	125	08/08→03/12					
2.0 TFSI	132 - 155	06/08→11/13					
2.0 TFSI quattro	155	06/08→01/17					
2.7 TDI	120 - 140	06/07→03/12					
3.0 TDI	150	10/11→01/17					
3.0 TDI quattro	155 - 180	06/07→01/17					
3.2 FSI	195	06/07→03/12					
3.2 FSI quattro	195	06/07→03/12					
S5 quattro	245 - 260	06/07→01/17					
2.0 TDI	120	08/08→01/17		10/08→		03.7858-4632.4 300273	ATE Ø 9 / 8" pneumatisch
 Hauptbremszylinder							
1.8 TFSI	118 - 125	10/07→01/17				03.2125-0493.3 010940	ATE Ø 25,4
2.0 TDI	125 - 130	08/08→01/17				24.2125-1739.3 010948	TRW Ø 25,4
2.0 TDI quattro	125	08/08→03/12					
2.0 TFSI	132 - 155	06/08→11/13					
2.0 TFSI quattro	155	06/08→01/17					
2.7 TDI	120 - 140	06/07→03/12					
3.0 TDI	150	10/11→01/17					
3.0 TDI quattro	155 - 180	06/07→01/17					
3.2 FSI	195	06/07→03/12					
3.2 FSI quattro	195	06/07→03/12					
S5 quattro	245 - 260	06/07→01/17					
2.0 TDI	120	08/08→01/17		10/08→		03.2125-0493.3 010940 24.2125-1739.3 010948	ATE Ø 25,4 TRW Ø 25,4
AUDI - A5 Cabriolet (8F7) 02/09→01/17							
 Bremskraftverstärker							
1.8 TFSI	118 - 125	09/09→03/16				03.7858-4632.4 300273	ATE Ø 9 / 8" pneumatisch
2.0 TDI	120 - 130	05/09→01/17					
2.0 TFSI	132	03/09→03/12					
2.0 TFSI quattro	155	03/09→01/17					
2.7 TDI	120 - 140	03/09→03/12					
3.0 TDI	150	10/11→01/17					
3.0 TDI quattro	176 - 180	03/09→01/17					
3.2 FSI	195	03/09→03/12					
3.2 FSI quattro	195	03/09→03/12					
S5 quattro	245	06/09→01/17					
2.0 TFSI	155	03/09→06/14		+PR 1LT		03.7858-4632.4 300273	ATE Ø 9 / 8" pneumatisch
 Hauptbremszylinder							
1.8 TFSI	118 - 125	09/09→03/16				03.2125-0493.3 010940	ATE Ø 25,4
2.0 TDI	120 - 130	05/09→01/17				24.2125-1739.3 010948	TRW Ø 25,4
2.0 TFSI	132	03/09→03/12					
2.0 TFSI quattro	155	03/09→01/17					
2.7 TDI	120 - 140	03/09→03/12					
3.0 TDI	150	10/11→01/17					
3.0 TDI quattro	176 - 180	03/09→01/17					
3.2 FSI	195	03/09→03/12					
3.2 FSI quattro	195	03/09→03/12					
S5 quattro	245	06/09→01/17					
2.0 TFSI	155	03/09→06/14		+PR 1LT		03.2125-0493.3 010940 24.2125-1739.3 010948	ATE Ø 25,4 TRW Ø 25,4
AUDI - A5 Sportback (8TA) 07/07→01/17							
 Bremskraftverstärker							
1.8 TFSI	118 - 125	11/09→01/17				03.7858-4632.4 300273	ATE Ø 9 / 8" pneumatisch
→							

	kw			 	! #		
AUDI - A5 Sportback (8TA) 07/07→01/17							
 Bremskraftverstärker							
2.0 TDI	100 - 130	09/09→01/17				03.7858-4632.4 300273	ATE Ø 9 / 8" pneumatisch
2.0 TDI quattro	125	09/09→03/12					
2.0 TFSI	132 - 155	09/09→06/14					
2.0 TFSI quattro	155	09/09→01/17					
2.7 TDI	120 - 140	09/09→03/12					
3.0 TDI	150	10/11→01/17					
3.0 TDI quattro	176 - 180	09/09→01/17					
3.2 FSI quattro	195	09/09→03/12					
S5 quattro	245	01/10→01/17					
 Hauptbremszylinder							
1.8 TFSI	118 - 125	11/09→01/17				03.2125-0493.3 010940	ATE Ø 25,4
2.0 TDI	100 - 130	09/09→01/17				24.2125-1739.3 010948	TRW Ø 25,4
2.0 TDI quattro	125	09/09→03/12					
2.0 TFSI	132 - 155	09/09→06/14					
2.0 TFSI quattro	155	09/09→01/17					
2.7 TDI	120 - 140	09/09→03/12					
3.0 TDI	150	10/11→01/17					
3.0 TDI quattro	176 - 180	09/09→01/17					
3.2 FSI quattro	195	09/09→03/12					
S5 quattro	245	01/10→01/17					
AUDI - A6 Allroad C6 (4FH) 03/06→08/11							
 Hauptbremszylinder							
2.7 TDI quattro	120 - 140	05/06→08/11		→ 05/11		24.2126-1705.3 010999	TRW Ø 27
3.0 TDI quattro	155 - 176	05/06→08/11					
3.0 TFSI quattro	213	10/08→08/11					
2.7 TDI quattro	132	03/06→10/08				24.2126-1705.3 010999	TRW Ø 27
3.0 TDI quattro	171	05/06→10/08					
3.2 FSI quattro	188	05/06→10/08					
4.2 FSI quattro	257	05/06→12/10					
AUDI - A6 Allroad C7 (4GH, 4GJ) 01/12→09/18							
 Hauptbremszylinder							
3.0 TDI quattro	140 - 235	01/12→09/18		für Linklenker		24.2125-1749.3 011031	TRW Ø 25,4
3.0 TFSI quattro	228 - 245	01/12→09/18					
AUDI - A6 C5 (4B2) 01/97→12/05							
 Bremskraftverstärker							
1.8	85 - 92	05/97→01/05		4B-2-130001→		03.7858-4502.4 300202	ATE Ø 9 / 8" pneumatisch
1.8 T	110 - 132	01/97→01/05					
1.8 T quattro	110 - 132	02/97→01/05					
1.9 TDI	81 - 96	04/97→01/05					
2.0	96	08/01→01/05					
2.4	100 - 125	02/97→01/05					
2.4 quattro	115 - 125	02/97→01/05					
2.5 TDI	110 - 132	07/97→01/05					
2.5 TDI quattro	110 - 132	07/97→01/05					
2.7 quattro	187	05/01→07/04					
2.7 T	169	02/99→01/05					
2.7 T quattro	169 - 184	12/97→01/05					
2.8	132 - 142	02/97→01/05					
2.8 quattro	132 - 142	02/97→01/05					
3.0	160 - 162	06/01→01/05					
→							

	kw			 	! #		
AUDI - A6 C5 (4B2) 01/97→12/05							
 Bremskraftverstärker							
3.0 quattro	160 - 162	06/01→01/05		4B-2-130001→		03.7858-4502.4 300202	ATE Ø 9 / 8" pneumatisch
3.7	191	03/99→01/05					
3.7 quattro	191	03/99→01/05					
4.2 quattro	220	11/98→01/05					
S6 quattro	250	09/99→01/05					
 Hauptbremszylinder							
1.8	85 - 92	05/97→01/05		4B-2-130136→		03.2125-0373.3 010810	ATE Ø 25,4
1.8 T	132	12/97→01/05		→ 4B-X-130000; + EDS		24.2123-1717.3 010521	Ø 23,8
1.8 T quattro	132	12/97→01/05		→ 4B-X-130000; + ESP		24.2123-1730.3 010620	Ø 23,8
1.9 TDI	85	07/00→01/05		4B-X-130001→; → 05/01; für Linkslenker; + EDS		24.2125-1712.3 010622	Ø 25,4
2.4	100	07/98→01/05					
2.5 TDI	110	07/97→01/05		4B-X-130001→; → 05/01; für Linkslenker; + ESP		24.2125-1713.3 010623	Ø 25,4
2.5 TDI quattro	110 - 132	07/97→01/05					
2.8	140	07/99→01/05		06/01→		24.2125-1720.3 010688	TRW Ø 25,4
1.8 T	110	01/97→01/05		4B-2-130136→		03.2125-0373.3 010810	ATE Ø 25,4
1.8 T quattro	110	02/97→01/05		04/97→; → 4B-X-130000; + EDS		24.2123-1717.3 010521	Ø 23,8
2.4	115 - 121	02/97→01/05		04/97→; → 4B-X-130000; + ESP		24.2123-1730.3 010620	Ø 23,8
2.4 quattro	120 - 121	02/97→01/05		4B-X-130001→; → 05/01; für Linkslenker; + EDS		24.2125-1712.3 010622	Ø 25,4
2.8	142	02/97→01/05		4B-X-130001→; → 05/01; für Linkslenker; + ESP		24.2125-1713.3 010623	Ø 25,4
2.8 quattro	142	02/97→01/05		06/01→		24.2125-1720.3 010688	TRW Ø 25,4
1.9 TDI	81	04/97→10/00		4B-2-130136→		03.2125-0373.3 010810	ATE Ø 25,4
2.4 quattro	115	08/98→07/99		→ 4B-X-130000; + EDS		24.2123-1717.3 010521	Ø 23,8
2.8	132	10/97→05/00		→ 4B-X-130000; + ESP		24.2123-1730.3 010620	Ø 23,8
2.8 quattro	132 - 140	01/98→05/01		4B-X-130001→; für Linkslenker; + EDS		24.2125-1712.3 010622	Ø 25,4
				4B-X-130001→; für Linkslenker; + ESP		24.2125-1713.3 010623	Ø 25,4
1.9 TDI	96	08/01→01/05		4B-2-130136→		03.2125-0373.3 010810	ATE Ø 25,4
2.4	125	08/01→01/05		→ 4B-X-130000; + EDS		24.2123-1717.3 010521	Ø 23,8
2.4 quattro	125	08/01→01/05		→ 4B-X-130000; + ESP		24.2123-1730.3 010620	Ø 23,8
2.5 TDI	114	08/01→01/05		→ 4B-X-130000; + ESP		24.2123-1730.3 010620	Ø 23,8
2.7 T quattro	184	08/01→01/05				24.2125-1720.3 010688	TRW Ø 25,4
2.0	96	08/01→01/05		4B-2-130136→		03.2125-0373.3 010810	ATE Ø 25,4
2.5 TDI	120	07/02→01/05				24.2125-1720.3 010688	TRW Ø 25,4
3.0	160 - 162	06/01→01/05					
3.0 quattro	160 - 162	06/01→01/05					
3.7	191	03/99→01/05					
3.7 quattro	191	03/99→01/05					
2.5 TDI	132	02/00→01/05		4B-2-130136→		03.2125-0373.3 010810	ATE Ø 25,4
2.7 T	169	02/99→01/05		→ 05/01; für Linkslenker; + EDS		24.2125-1712.3 010622	Ø 25,4
				→ 05/01; für Linkslenker; + ESP		24.2125-1713.3 010623	Ø 25,4
				06/01→		24.2125-1720.3 010688	TRW Ø 25,4
2.7 quattro	187	05/01→07/04		4B-2-130136→		03.2125-0373.3 010810	ATE Ø 25,4
2.7 T quattro	169	12/97→01/05		→ 4B-X-130000; + EDS		24.2123-1717.3 010521	Ø 23,8
				→ 4B-X-130000; + ESP		24.2123-1730.3 010620	Ø 23,8
				→ 05/01; für Linkslenker; + EDS		24.2125-1712.3 010622	Ø 25,4
				4B-X-130001→; → 05/01; für Linkslenker; + ESP		24.2125-1713.3 010623	Ø 25,4
				06/01→		24.2125-1720.3 010688	TRW Ø 25,4
4.2 quattro	220	11/98→01/05		4B-2-130136→		03.2125-0373.3 010810	ATE Ø 25,4
				→ 05/01; + EDS		24.2125-1712.3 010622	Ø 25,4
				→ 05/01; + ESP		24.2125-1713.3 010623	Ø 25,4
				06/01→		24.2125-1720.3 010688	TRW Ø 25,4
RS6 quattro	331	07/02→01/05				24.2126-1705.3 010999	TRW Ø 27
S6 quattro	250	09/99→01/05		4B-2-130136→		03.2125-0373.3 010810	ATE Ø 25,4
				→ 05/01		24.2125-1712.3 010622	Ø 25,4
						24.2125-1713.3 010623	Ø 25,4
				06/01→		24.2125-1720.3 010688	TRW Ø 25,4
AUDI - A6 C5 Avant (4B5) 11/97→01/05							
 Bremskraftverstärker							
1.8	85 - 92	12/97→01/05		4B-2-130001→		03.7858-4502.4 300202	ATE Ø 9 / 8" pneumatisch
→							













AUDI - A6 C5 Avant (4B5) 11/97→01/05











Bremskraftverstärker













1.8 T	110 - 132	12/97→01/05	4B-2-130001→		03.7858-4502.4 300202	ATE Ø 9 / 8" pneumatisch
1.8 T quattro	110 - 132	12/97→01/05				
1.9 TDI	81 - 96	02/98→01/05				
2.0	96	08/01→01/05				
2.4	100 - 125	12/97→01/05				
2.4 quattro	115 - 125	12/97→01/05				
2.5 TDI	110 - 132	12/97→01/05				
2.5 TDI quattro	110 - 132	12/97→01/05				
2.7 T	169	02/99→01/05				
2.7 T quattro	169 - 184	12/97→01/05				
2.8	132 - 142	12/97→01/05				
2.8 quattro	142	12/97→01/05				
3.0	160 - 162	06/01→01/05				
3.0 quattro	160 - 162	06/01→01/05				
3.7	191	03/99→01/05				
3.7 quattro	191	03/99→01/05				
4.2 quattro	220	11/98→01/05				
S6 quattro	250	09/99→01/05				











Hauptbremszylinder













1.8	85 - 92	12/97→01/05	4B-2-130136→		03.2125-0373.3 010810	ATE Ø 25,4
1.8 T	110 - 132	12/97→01/05	→ 4B-X-130000; + EDS		24.2123-1717.3 010521	Ø 23,8
1.8 T quattro	110 - 132	12/97→01/05	→ 4B-X-130000; + ESP		24.2123-1730.3 010620	Ø 23,8
1.9 TDI	85	07/00→01/05	4B-X-130001→; → 05/01; für Linkslenker; + EDS		24.2125-1712.3 010622	Ø 25,4
2.4	100 - 121	12/97→01/05	4B-X-130001→; → 05/01; für Linkslenker; + ESP		24.2125-1713.3 010623	Ø 25,4
2.4 quattro	120 - 121	12/97→01/05	06/01→		24.2125-1720.3 010688	TRW Ø 25,4
2.5 TDI	110	12/97→01/05				
2.5 TDI quattro	110 - 132	12/97→01/05				
2.8	140 - 142	12/97→01/05				
2.8 quattro	142	12/97→01/05				
1.9 TDI	81	02/98→04/01	4B-2-130136→		03.2125-0373.3 010810	ATE Ø 25,4
2.4 quattro	115	08/98→05/01	→ 4B-X-130000; + EDS		24.2123-1717.3 010521	Ø 23,8
2.8	132	12/97→05/00	→ 4B-X-130000; + ESP		24.2123-1730.3 010620	Ø 23,8
			4B-X-130001→; für Linkslenker; + EDS		24.2125-1712.3 010622	Ø 25,4
			4B-X-130001→; für Linkslenker; + ESP		24.2125-1713.3 010623	Ø 25,4
1.9 TDI	96	08/01→01/05	4B-2-130136→		03.2125-0373.3 010810	ATE Ø 25,4
2.4	125	08/01→01/05	→ 4B-X-130000; + EDS		24.2123-1717.3 010521	Ø 23,8
2.4 quattro	125	08/01→01/05	→ 4B-X-130000; + ESP		24.2123-1730.3 010620	Ø 23,8
2.5 TDI	114	08/01→01/05				
2.7 T quattro	184	08/01→01/05			24.2125-1720.3 010688	TRW Ø 25,4
2.0	96	08/01→01/05	4B-2-130136→		03.2125-0373.3 010810	ATE Ø 25,4
2.5 TDI	120	07/02→01/05				
3.0	160 - 162	06/01→01/05			24.2125-1720.3 010688	TRW Ø 25,4
3.0 quattro	160 - 162	06/01→01/05				
3.7	191	03/99→01/05				
3.7 quattro	191	03/99→01/05				
2.5 TDI	132	02/00→01/05	4B-2-130136→		03.2125-0373.3 010810	ATE Ø 25,4
2.7 T	169	02/99→01/05	→ 05/01; für Linkslenker; + EDS		24.2125-1712.3 010622	Ø 25,4
			→ 05/01; für Linkslenker; + ESP		24.2125-1713.3 010623	Ø 25,4
			06/01→		24.2125-1720.3 010688	TRW Ø 25,4
2.7 T quattro	169	12/97→01/05	4B-2-130136→		03.2125-0373.3 010810	ATE Ø 25,4
			→ 4B-X-130000; + EDS		24.2123-1717.3 010521	Ø 23,8
			→ 4B-X-130000; + ESP		24.2123-1730.3 010620	Ø 23,8
			→ 05/01; für Linkslenker; + EDS		24.2125-1712.3 010622	Ø 25,4
			4B-X-130001→; → 05/01; für Linkslenker; + ESP		24.2125-1713.3 010623	Ø 25,4
			06/01→		24.2125-1720.3 010688	TRW Ø 25,4

	kW			 	! #		
AUDI - A6 C5 Avant (4B5) 11/97→01/05							
 Hauptbremszylinder							
4.2 quattro	220	11/98→01/05		4B-2-130136→		03.2125-0373.3 010810	ATE Ø 25,4
				→ 05/01; + EDS		24.2125-1712.3 010622	Ø 25,4
				→ 05/01; + ESP		24.2125-1713.3 010623	Ø 25,4
				06/01→		24.2125-1720.3 010688	TRW Ø 25,4
RS6 plus quattro	353	04/04→01/05				24.2126-1705.3 010999	TRW Ø 27
RS6 quattro	331	07/02→01/05					
S6 quattro	250	09/99→01/05		4B-2-130136→		03.2125-0373.3 010810	ATE Ø 25,4
				→ 05/01		24.2125-1712.3 010622	Ø 25,4
						24.2125-1713.3 010623	Ø 25,4
				06/01→		24.2125-1720.3 010688	TRW Ø 25,4
AUDI - A6 C6 (4F2) 04/04→08/11							
 Hauptbremszylinder							
2.0 TDI	89 - 125	07/04→03/11				24.2126-1705.3 010999	TRW Ø 27
2.0 TFSI	125	06/05→03/11					
2.4	130	05/04→10/08					
2.4 quattro	130	01/05→10/08					
2.7 TDI	120 - 140	11/04→03/11					
2.7 TDI quattro	120 - 140	11/04→03/11					
2.8 FSI	140 - 162	11/06→03/11					
2.8 FSI quattro	140 - 162	06/07→03/11					
3.0	160	08/04→05/06					
3.0 quattro	160	05/04→05/06					
3.0 TDI quattro	155 - 176	05/04→03/11					
3.0 TFSI quattro	213 - 220	10/08→03/11					
3.2 FSI	188 - 195	05/04→03/11					
3.2 FSI quattro	183 - 188	05/04→10/08					
4.2 FSI quattro	257	06/06→03/11					
4.2 quattro	246	05/04→05/06					
RS6 quattro	426	09/08→08/10					
S6 quattro	320	03/06→03/11					
2.0 TDI	100	07/04→03/11		06/05→		24.2126-1705.3 010999	TRW Ø 27
AUDI - A6 C6 Avant (4F5) 11/04→08/11							
 Hauptbremszylinder							
2.0 TDI	89 - 125	06/05→08/11				24.2126-1705.3 010999	TRW Ø 27
2.0 TFSI	125	06/05→08/11					
2.4	130	03/05→10/08					
2.4 quattro	130	03/05→10/08					
2.7 TDI	120 - 140	03/05→08/11					
2.7 TDI quattro	120 - 140	11/04→08/11					
2.8 FSI	140 - 162	11/06→08/11					
2.8 FSI quattro	140 - 162	06/07→08/11					
3.0	160	03/05→05/06					
3.0 quattro	160	03/05→05/06					
3.0 TDI quattro	155 - 176	03/05→08/11					
3.0 TFSI quattro	213 - 220	10/08→08/11					
3.2 FSI	188	03/05→10/08					
3.2 FSI quattro	188	03/05→10/08					
4.2 FSI quattro	257	06/06→08/11					
4.2 quattro	246	03/05→05/06					
RS6 quattro	426	04/08→08/10					
S6 quattro	320	03/06→08/11					
AUDI - A6 C7 (4G2, 4GC) 11/10→09/18							
 Hauptbremszylinder							
1.8 TFSI	140	09/14→09/18		für Linkslenker		24.2125-1749.3 011031	TRW Ø 25,4
2.0 TDI	100 - 140	01/12→09/18					
2.0 TDI quattro	140	04/15→09/18					
→							













	kw			 	! #		
AUDI - A6 C7 (4G2, 4GC) 11/10→09/18							
 Hauptbremszylinder							
2.0 TFSI	132 - 185	05/11→09/18		für Linkslenker		24.2125-1749.3 011031	TRW Ø 25,4
2.0 TFSI Hybrid	180	11/11→04/15					
2.0 TFSI quattro	155 - 185	05/12→09/18					
2.8 FSI quattro	162	09/14→09/18					
3.0 TDI	155 - 160	09/14→09/18					
3.0 TDI quattro	155 - 240	09/14→09/18					
3.0 TFSI quattro	245 - 250	09/14→09/18					
S6 quattro	331	10/14→09/18					
2.0 TDI	120 - 130	03/11→09/18		04/11→; für Linkslenker		24.2125-1749.3 011031	TRW Ø 25,4
2.0 TFSI	155	03/11→05/13					
2.8 FSI	150	11/10→04/15					
2.8 FSI quattro	150	11/10→04/15					
3.0 TDI	150	11/10→09/18					
3.0 TDI quattro	150 - 180	03/11→09/18					
3.0 TFSI quattro	220 - 228	11/10→09/18					
2.0 TFSI	162	05/13→09/18		09/14→; für Linkslenker		24.2125-1749.3 011031	TRW Ø 25,4
3.0 TDI quattro	230	11/11→09/18		12/11→; für Linkslenker		24.2125-1749.3 011031	TRW Ø 25,4
S6 quattro	309	02/12→09/18		04/12→; für Linkslenker		24.2125-1749.3 011031	TRW Ø 25,4
AUDI - A6 C7 Avant (4G5, 4GD) 05/11→09/18							
 Hauptbremszylinder							
1.8 TFSI	140	09/14→09/18		für Linkslenker		24.2125-1749.3 011031	TRW Ø 25,4
2.0 TDI	100 - 140	01/12→09/18					
2.0 TDI quattro	140	04/15→09/18					
2.0 TFSI	132 - 185	06/11→09/18					
2.0 TFSI quattro	183 - 185	05/15→09/18					
2.8 FSI quattro	162	09/14→09/18					
3.0 TDI	155 - 160	09/14→09/18					
3.0 TDI quattro	155 - 240	09/14→09/18					
3.0 TFSI quattro	228 - 245	11/11→09/18					
RS6 performance quattro	445	11/15→09/18					
S6 quattro	331	10/14→09/18					
2.0 TDI	120 - 130	05/11→09/18		09/11→; für Linkslenker		24.2125-1749.3 011031	TRW Ø 25,4
2.8 FSI	150	05/11→04/15					
2.8 FSI quattro	150	05/11→04/15					
3.0 TDI	150	05/11→09/18					
3.0 TDI quattro	150 - 180	05/11→09/18					
3.0 TFSI quattro	220	05/11→05/12					
3.0 TDI quattro	230	11/11→09/18		12/11→; für Linkslenker		24.2125-1749.3 011031	TRW Ø 25,4
RS6 quattro	412	01/13→09/18		03/13→; für Linkslenker		24.2125-1749.3 011031	TRW Ø 25,4
S6 quattro	309	02/12→09/18		04/12→; für Linkslenker		24.2125-1749.3 011031	TRW Ø 25,4
AUDI - A7 Sportback (4GA, 4GF) 07/10→05/18							
 Hauptbremszylinder							
1.8 TFSI	140	04/15→05/18		für Linkslenker		24.2125-1749.3 011031	TRW Ø 25,4
2.0 TFSI	185	09/14→05/18					
2.0 TFSI quattro	183 - 185	05/15→05/18					
2.8 FSI quattro	150 - 162	10/10→05/18					
3.0 TDI	140 - 160	11/10→05/18					
3.0 TDI quattro	140 - 240	10/10→05/18					
3.0 TFSI quattro	220 - 245	10/10→05/18					
3.0 TFSI QUATTRO	250	05/16→05/18					
RS7 performance quattro	445	11/15→04/18					
RS7 quattro	412	10/13→04/18					
S7 quattro	309 - 331	02/12→05/18					
→							















	kw			 	! #		
AUDI - A7 Sportback (4GA, 4GF) 07/10→05/18							
 Hauptbremszylinder							
2.8 FSI	150	02/11→03/15		05/11→; für Linkslenker		24.2125-1749.3 011031	TRW Ø 25,4
AUDI - A8 D2 (4D2, 4D8) 03/94→12/05							
 Hauptbremszylinder							
2.5 TDI	110	01/97→04/00		06/97→; - ESP		24.2125-1712.3 010622	Ø 25,4
				06/97→; + ESP		24.2125-1713.3 010623	Ø 25,4
2.5 TDI	132	09/00→09/02		- ESP		24.2125-1712.3 010622	Ø 25,4
2.5 TDI quattro	110 - 132	07/97→09/02		+ ESP		24.2125-1713.3 010623	Ø 25,4
2.8	142	04/96→09/02					
2.8 quattro	142	04/96→09/02					
3.3 TDI quattro	165	06/00→09/02					
3.7	191	11/98→09/02					
3.7 quattro	191	11/98→09/02					
4.2 quattro	175 - 228	11/98→09/02					
6.0 W12 quattro	309	01/01→09/02					
S8 quattro	250 - 265	07/96→09/02					
AUDI - A8 D4 (4H2, 4H8, 4HC, 4HL) 11/09→01/18							
 Hauptbremszylinder							
2.0 TFSI hybrid	180	02/12→11/15		05/12→; nicht für gepanzerte Fahrzeuge		24.2125-1739.3 010948	TRW Ø 25,4
2.0 TFSI quattro	185	09/16→01/18		nicht für gepanzerte Fahrzeuge		24.2125-1739.3 010948	TRW Ø 25,4
2.5 TFSI	150	07/12→06/16					
3.0 TDI	150	09/11→09/13					
3.0 TDI quattro	155 - 193	07/10→01/18					
3.0 TFSI quattro	213 - 228	07/10→01/18					
4.0 TFSI quattro	309 - 320	03/12→12/15					
4.2 FSI quattro	273	11/09→12/12					
4.2 TDI quattro	258 - 283	11/09→01/18					
6.3 W12 quattro	368	01/11→01/18					
S8 plus quattro	445	11/15→01/18					
S8 quattro	382	04/12→01/18					
3.0 TFSI quattro	245	06/10→01/18		07/10→; nicht für gepanzerte Fahrzeuge		24.2125-1739.3 010948	TRW Ø 25,4
AUDI - ALLROAD C5 (4BH) 05/00→08/05							
 Hauptbremszylinder							
2.5 TDI quattro	120 - 132	05/00→08/05		für Linkslenker; → 07/05		24.2125-1713.3 010623	Ø 25,4
2.7 quattro	187	09/00→08/05					
2.7 T quattro	184	05/00→08/05					
4.2 V8 quattro	220	07/02→08/05					
AUDI - CABRIOLET B3 (8G7) 05/91→08/00							
 Hauptbremszylinder							
1.9 TDI	66	06/95→08/00		07/95→; → 8G-V-010000; für Rechtslenker; - ABS		03.2122-9612.3 010159	Ø 22,2
				07/95→; für Linkslenker; + ABS		24.2123-1602.3 010384	TRW Ø 23,8
2.6	110	06/93→08/00		01/94→; für Linkslenker		24.2123-1602.3 010384	TRW Ø 23,8
2.8	128	11/92→08/00		für Linkslenker		24.2123-1602.3 010384	TRW Ø 23,8
Verschlusschraube, Hauptbremszylinder							
1.9 TDI	66	06/95→08/00		8G-P-000001→ 8G-V-010000; für Linkslenker; - ABS		03.3517-0101.2 390322	
AUDI - Q2 (GAB, GAG) 06/16→							
 Hauptbremszylinder							
1.0 TFSI	85	10/16→10/20		für Linkslenker; → 03/18		24.4123-1719.3 011017	TRW Ø 23,8 ohne Bremsflüssigkeitsbehälter
2.0 TDI	110	09/16→					
2.0 TDI quattro	110	09/16→		für Linkslenker; → 11/18		24.4153-1522.3 011048	ATE Ø 23,8 ohne Bremsflüssigkeitsbehälter
2.0 TFSI quattro	140	05/17→					
35 TDI	110	09/16→		für Linkslenker; 12/18→; +PR 1ZA / 1ZB / 1ZE / 1ZJ / 1ZK / 1ZU		24.4153-1522.3 011048	ATE Ø 23,8 ohne Bremsflüssigkeitsbehälter
1.4 TFSI	110	06/16→08/18		für Linkslenker; → 03/18		24.4123-1719.3 011017	TRW Ø 23,8 ohne Bremsflüssigkeitsbehälter
1.6 TDI	85	06/16→07/18					
2.0 TDI quattro	140	07/16→08/18		für Linkslenker		24.4153-1522.3 011048	ATE Ø 23,8 ohne Bremsflüssigkeitsbehälter
→							











	kw					! #			
AUDI - Q2 (GAB, GAG) 06/16→									
 Hauptbremszylinder									
30 TDI	85	07/18→10/20			für Linkslenker; → 11/18		24.4153-1522.3	011048	ATE Ø 23,8 ohne Bremsflüssigkeitsbehälter
30 TFSI	85	07/18→10/20							
35 TDI quattro	110	09/18→							
35 TFSI	110	07/18→			für Linkslenker; 12/18→; +PR 1ZA / 1ZB / 1ZE / 1ZJ / 1ZK / 1ZU		24.4153-1522.3	011048	ATE Ø 23,8 ohne Bremsflüssigkeitsbehälter
40 TFSI quattro	140	09/18→							
SQ2 TFSI quattro	221	08/18→							
30 TFSI	81	08/20→			für Linkslenker; +PR 1ZA / 1ZB / 1ZE / 1ZJ / 1ZK / 1ZU		24.4153-1522.3	011048	ATE Ø 23,8 ohne Bremsflüssigkeitsbehälter
AUDI - Q3 (8UB, 8UG) 06/11→03/20									
 Hauptbremszylinder									
1.4 TFSI	92	07/16→10/18			für Linkslenker		03.2123-3549.3	010809	ATE Ø 23,8
1.4 TSI	110	10/13→10/18							
2.0 TDI	88 - 135	06/11→10/18			für Rechtslenker		24.4153-0192.3	011026	ATE Ø 23,8 ohne Bremsflüssigkeitsbehälter
2.0 TDI quattro	103 - 135	06/11→10/18							
2.0 TFSI	132	05/15→10/18			für Linkslenker		03.4153-0186.3	010816	ATE Ø 23,8
2.0 TFSI quattro	132 - 162	11/14→10/18			für Rechtslenker		24.4153-0192.3	011026	ATE Ø 23,8 ohne Bremsflüssigkeitsbehälter
2.0 TFSI quattro	125 - 155	06/11→10/18			für Linkslenker		03.2123-3549.3	010809	ATE Ø 23,8
					für Rechtslenker		03.4153-0186.3	010816	ATE Ø 23,8
							24.4153-0192.3	011026	ATE Ø 23,8 ohne Bremsflüssigkeitsbehälter
RS 2.5 quattro	228	10/13→10/18			für Linkslenker		03.2125-5112.3	010966	ATE Ø 25,4
RS performance 2.5 quattro	270	01/15→10/18							
RS 2.5 quattro	250	05/13→10/18			03/15→; für Linkslenker		03.2125-5112.3	010966	ATE Ø 25,4
AUDI - Q5 (8RB) 11/08→12/17									
 Bremskraftverstärker									
2.0 TDI	100 - 140	11/10→05/17					03.7858-4432.4	300304	ATE Ø 9 / 8" pneumatisch
2.0 TDI quattro	100 - 140	08/09→05/17							
2.0 TFSI quattro	132 - 169	08/09→05/17							
3.0 TDI quattro	190	11/13→05/17							
SQ5 TDI quattro	230 - 250	12/12→05/17							
SQ5 TFSI quattro	260	05/13→05/17							
2.0 TDI quattro	120 - 125	11/08→05/17			→ 02/09		03.7858-4432.4	300304	ATE Ø 9 / 8" pneumatisch
2.0 TFSI quattro	155	11/08→09/12			03/09→		03.7858-4432.4	300304	ATE Ø 9 / 8" pneumatisch
3.0 TDI quattro	155 - 176	11/08→05/17							
3.2 FSI quattro	199	11/08→12/12							
2.0 TDI quattro	130	06/12→05/17			09/12→		03.7858-4432.4	300304	ATE Ø 9 / 8" pneumatisch
2.0 TFSI quattro	165	06/12→05/16							
3.0 TDI quattro	180 - 184	06/12→05/17							
3.0 TFSI quattro	200	06/12→05/17							
2.0 TFSI Hybrid quattro	180	06/11→06/16					03.7858-4632.4	300273	ATE Ø 9 / 8" pneumatisch
 Hauptbremszylinder									
2.0 TDI	100 - 140	11/10→05/17					03.2125-0493.3	010940	ATE Ø 25,4
2.0 TDI quattro	100 - 140	08/09→05/17							
2.0 TFSI quattro	132 - 162	08/09→05/17							
3.0 TDI quattro	190	11/13→05/17							
SQ5 TDI quattro	230 - 250	12/12→05/17							
SQ5 TFSI quattro	260	05/13→05/17							
2.0 TDI quattro	120 - 125	11/08→05/17			03/09→		03.2125-0493.3	010940	ATE Ø 25,4
2.0 TFSI quattro	155	11/08→09/12							
3.0 TDI quattro	155 - 176	11/08→05/17							
3.2 FSI quattro	199	11/08→12/12							
2.0 TDI quattro	130	06/12→05/17			09/12→		03.2125-0493.3	010940	ATE Ø 25,4
2.0 TFSI quattro	165	06/12→05/16							
3.0 TDI quattro	180 - 184	06/12→05/17							
3.0 TFSI quattro	200	06/12→05/17							











	kw			 	! #		
AUDI - Q5 Van (8RB) 11/08→12/17							
 Bremskraftverstärker							
2.0 TDI	100 - 140	11/11→05/17				03.7858-4432.4 300304	ATE Ø 9 / 8" pneumatisch
3.0 SQ5 TDI quattro	230 - 250	12/12→05/17					
3.0 TDI quattro	190	11/13→05/17					
2.0 TDI quattro	125	11/08→09/12		→ 02/09		03.7858-4432.4 300304	ATE Ø 9 / 8" pneumatisch
2.0 TFSI quattro	155	11/08→09/12					
3.0 TDI quattro	176	11/08→04/13		03/09→		03.7858-4432.4 300304	ATE Ø 9 / 8" pneumatisch
3.2 FSI quattro	199	11/08→09/12					
2.0 TDI quattro	130	07/12→06/14		09/12→		03.7858-4432.4 300304	ATE Ø 9 / 8" pneumatisch
3.0 TDI quattro	180	06/12→05/17					
 Hauptbremszylinder							
2.0 TDI	100 - 140	11/11→05/17				03.2125-0493.3 010940	ATE Ø 25,4
3.0 SQ5 TDI quattro	230 - 250	12/12→05/17					
3.0 TDI quattro	190	11/13→05/17					
2.0 TDI quattro	125	11/08→09/12		03/09→		03.2125-0493.3 010940	ATE Ø 25,4
2.0 TFSI quattro	155	11/08→09/12					
3.0 TDI quattro	176	11/08→04/13					
3.2 FSI quattro	199	11/08→09/12					
2.0 TDI quattro	130	07/12→06/14		09/12→		03.2125-0493.3 010940	ATE Ø 25,4
3.0 TDI quattro	180	06/12→05/17					
AUDI - Q7 (4LB) 03/06→01/16							
 Bremskraftverstärker							
3.0 TDI quattro	150 - 180	03/06→08/15		für Linkslenker; für Fahrzeuge ohne autom. Distanzregelung		03.7868-5802.4 300315	ATE Ø 10 / 8" pneumatisch
3.0 TFSI quattro	200 - 245	05/10→08/15		für Linkslenker; für Fahrzeuge mit autom. Distanzregelung		03.7868-5902.4 300316	ATE Ø 10 / 8" pneumatisch
3.6 FSI quattro	206	08/06→05/10					
4.2 FSI quattro	257	03/06→05/10					
4.2 TDI quattro	240 - 250	03/07→08/15					
6.0 TDI quattro	368	09/08→05/14					
Pedalwegsensor, Bremspedal							
3.0 TDI quattro	150 - 180	03/06→08/15		für Fahrzeuge mit autom. Distanzregelung		03.0655-0006.2 370006	ATE
3.0 TFSI quattro	200 - 245	05/10→08/15					
3.6 FSI quattro	206	08/06→05/10					
4.2 FSI quattro	257	03/06→05/10					
4.2 TDI quattro	240 - 250	03/07→08/15					
6.0 TDI quattro	368	09/08→05/14					
 Hauptbremszylinder							
3.0 TDI quattro	150 - 180	03/06→08/15		für Linkslenker		03.2126-3063.3 010812	ATE Ø 27
3.0 TFSI quattro	200 - 245	05/10→08/15		für Rechtslenker		24.2126-3071.3 011037	ATE Ø 27 ohne Bremsflüssigkeitsbehälter
3.6 FSI quattro	206	08/06→05/10					
4.2 FSI quattro	257	03/06→05/10					
4.2 TDI quattro	240 - 250	03/07→08/15					
6.0 TDI quattro	368	09/08→05/14					
3.0 TDI quattro	165	06/09→05/12		für Linkslenker		03.2126-3063.3 010812	ATE Ø 27
				→ 05/10; für Rechtslenker		24.2126-3071.3 011037	ATE Ø 27 ohne Bremsflüssigkeitsbehälter
AUDI - Q7 Van (4LB) 03/06→01/16							
 Bremskraftverstärker							
3.0 TDI quattro	150 - 180	03/06→08/15		für Linkslenker; für Fahrzeuge ohne autom. Distanzregelung		03.7868-5802.4 300315	ATE Ø 10 / 8" pneumatisch
3.0 TFSI quattro	245	05/10→08/15		für Fahrzeuge mit autom. Distanzregelung; für Linkslenker		03.7868-5902.4 300316	ATE Ø 10 / 8" pneumatisch
3.6 FSI quattro	206	08/06→05/10					
4.2 FSI quattro	257	08/06→05/10					
4.2 TDI quattro	240 - 250	03/07→08/15					
6.0 TDI quattro	368	09/08→05/14					
Pedalwegsensor, Bremspedal							
3.0 TDI quattro	150 - 180	03/06→08/15		für Fahrzeuge mit autom. Distanzregelung		03.0655-0006.2 370006	ATE
3.0 TFSI quattro	245	05/10→08/15					
3.6 FSI quattro	206	08/06→05/10					
→							























	kw					! #		
AUDI - Q7 Van (4LB) 03/06→01/16								
Pedalwegsensord, Bremspedal								
4.2 FSI quattro	257	08/06→05/10		für Fahrzeuge mit autom. Distanzregelung		03.0655-0006.2	370006	ATE
4.2 TDI quattro	240 - 250	03/07→08/15						
6.0 TDI quattro	368	09/08→05/14						
 Hauptbremszylinder								
3.0 TDI quattro	150 - 180	03/06→08/15		für Linkslenker		03.2126-3063.3	010812	ATE Ø 27
3.0 TFSI quattro	245	05/10→08/15		für Rechtslenker		24.2126-3071.3	011037	ATE Ø 27 ohne Bremsflüssigkeitsbehälter
3.6 FSI quattro	206	08/06→05/10						
4.2 FSI quattro	257	08/06→05/10						
4.2 TDI quattro	240 - 250	03/07→08/15						
6.0 TDI quattro	368	09/08→05/14						
AUDI - TT (8J3) 07/06→01/15								
 Bremskraftverstärker								
1.8 TFSI	118	06/08→06/14		für Linkslenker		03.7860-4203.4	300243	ATE Ø 10" pneumatisch
2.0 TDI quattro	125	06/08→06/14						
2.0 TFSI	147 - 155	08/06→06/14						
2.0 TFSI quattro	147 - 155	06/08→06/14						
2.0 TTS quattro	195	05/08→06/14						
2.0 TTS quattro	200	05/08→06/14		für Linkslenker		03.7870-0602.4	300310	ATE Ø 11" pneumatisch
2.5 RS quattro	250	07/09→06/14						
2.5 RS quattro	265	05/11→06/14		02/12→; für Linkslenker		03.7870-0602.4	300310	ATE Ø 11" pneumatisch
3.2 V6 quattro	184	08/06→06/10		für Linkslenker; +PR 1AT		03.7870-0602.4	300310	ATE Ø 11" pneumatisch
 Hauptbremszylinder								
1.8 TFSI	118	06/08→06/14		für Linkslenker		03.2123-3549.3	010809	ATE Ø 23,8
2.0 TDI quattro	125	06/08→06/14		für Rechtslenker		24.4153-0217.3	011039	ATE Ø 23,8 ohne Bremsflüssigkeitsbehälter
2.0 TFSI	147 - 155	08/06→06/14						
2.0 TFSI quattro	147 - 155	06/08→06/14						
2.0 TTS quattro	195	05/08→06/14						
2.0 TTS quattro	200	05/08→06/14		für Linkslenker		03.2125-5112.3	010966	ATE Ø 25,4
2.5 RS quattro	250 - 265	07/09→06/14						
3.2 V6 quattro	184	08/06→06/10						
Drucksensord, Bremskraftverstärker								
2.0 TTS quattro	200	05/08→06/14		für Rechtslenker; +PR 1AS		03.0655-0101.2	370008	ATE
2.5 RS quattro	250 - 265	07/09→06/14						
3.2 V6 quattro	184	08/06→06/10		für Linkslenker; +PR 1AS		03.0655-0101.2	370008	ATE
AUDI - TT (8N3) 10/98→12/06								
 Bremskraftverstärker								
1.8 T	110 - 140	09/02→06/06		für Linkslenker		03.7860-0602.4	300141	ATE Ø 10" pneumatisch
1.8 T quattro	140 - 180	03/05→06/06						
3.2 VR6 quattro	184	07/03→06/06						
1.8 T	132	10/98→06/06		8N-2-014301→; für Linkslenker		03.7860-0602.4	300141	ATE Ø 10" pneumatisch
1.8 T quattro	132 - 165	10/98→06/06		→ 8N-2-014300; für Linkslenker; + ESP		03.7863-0402.4	300124	ATE Ø 10" pneumatisch
 Hauptbremszylinder								
1.8 T	132	10/98→06/06		→ 8N-2-014300; für Linkslenker; + ESP		03.2123-2024.3	010597	ATE Ø 23,8
1.8 T quattro	132 - 165	10/98→06/06		8N-2-014301→; → 08/02; für Linkslenker		03.2123-2715.3	010802	ATE Ø 23,8
				8N-2-014301→; → 08/02; für Rechtslenker		03.2123-2774.3	010803	ATE Ø 23,8
				→ 8N-2-014300; für Linkslenker; - ESP		24.2123-1709.3	010503	Ø 23,8
AUDI - TT (FV3, FVP) 07/14→								
 Hauptbremszylinder								
1.8 TFSI	132	07/15→08/18		für Linkslenker		24.4123-1719.3	011017	TRW Ø 23,8 ohne Bremsflüssigkeitsbehälter
2.0 TDI	135	07/14→						
2.0 TDI quattro	135	01/17→						
2.0 TFSI	169	07/14→						
2.0 TFSI quattro	162 - 169	07/14→						
→								











	kw					! #		
AUDI - TT (FV3, FVP) 07/14→								
 Hauptbremszylinder								
2.0 TTS quattro	210 - 228	11/14→		für Linkslenker		24.4123-1719.3	011017	TRW Ø 23,8 ohne Bremsflüssigkeitsbehälter
40 TFSI	145	07/18→						
45 TFSI	180	07/18→						
45 TFSI quattro	180	07/18→						
TTS quattro	235	01/21→						
AUDI - TT Roadster (8J9) 03/07→06/14								
 Bremskraftverstärker								
1.8 TFSI	118	06/08→06/14		für Linkslenker		03.7860-4203.4	300243	ATE Ø 10" pneumatisch
2.0 TDI quattro	125	06/08→06/14						
2.0 TFSI	147 - 155	03/07→06/14						
2.0 TFSI quattro	147 - 155	06/08→06/14						
2.0 TTS quattro	195	05/08→06/14						
2.0 TTS quattro	200	05/08→06/14		für Linkslenker		03.7870-0602.4	300310	ATE Ø 11" pneumatisch
2.5 RS quattro	250 - 265	07/09→06/14						
3.2 V6 quattro	184	03/07→06/10		für Linkslenker; +PR 1AT		03.7870-0602.4	300310	ATE Ø 11" pneumatisch
 Hauptbremszylinder								
1.8 TFSI	118	06/08→06/14		für Linkslenker		03.2123-3549.3	010809	ATE Ø 23,8
2.0 TDI quattro	125	06/08→06/14						
2.0 TFSI	147	03/07→06/10		für Rechtslenker		24.4153-0217.3	011039	ATE Ø 23,8 ohne Bremsflüssigkeitsbehälter
2.0 TFSI quattro	147	06/08→06/10						
2.0 TTS quattro	195	05/08→06/14						
2.0 TTS quattro	200	05/08→06/14		für Linkslenker		03.2125-5112.3	010966	ATE Ø 25,4
2.5 RS quattro	250 - 265	07/09→06/14						
3.2 V6 quattro	184	03/07→06/10						
Drucksensor, Bremskraftverstärker								
2.0 TTS quattro	200	05/08→06/14		für Rechtslenker; +PR 1AS		03.0655-0101.2	370008	ATE
2.5 RS quattro	250 - 265	07/09→06/14						
3.2 V6 quattro	184	03/07→06/10		für Linkslenker; +PR 1AS		03.0655-0101.2	370008	ATE
AUDI - TT Roadster (8N9) 10/99→12/06								
 Bremskraftverstärker								
1.8 T	110 - 132	10/99→06/06		8N-2-014301→; für Linkslenker		03.7860-0602.4	300141	ATE Ø 10" pneumatisch
1.8 T quattro	132 - 165	10/99→06/06		→ 8N-2-014300; für Linkslenker; + ESP		03.7863-0402.4	300124	ATE Ø 10" pneumatisch
1.8 T	120 - 140	09/05→06/06		für Linkslenker		03.7860-0602.4	300141	ATE Ø 10" pneumatisch
1.8 T quattro	140	09/05→06/06						
3.2 VR6 quattro	184	07/03→06/06						
 Hauptbremszylinder								
1.8 T	110 - 132	10/99→06/06		→ 8N-2-014300; für Linkslenker; + ESP		03.2123-2024.3	010597	ATE Ø 23,8
1.8 T quattro	132 - 165	10/99→06/06		8N-2-014301→; → 08/02; für Linkslenker		03.2123-2715.3	010802	ATE Ø 23,8
				8N-2-014301→; → 08/02; für Rechtslenker		03.2123-2774.3	010803	ATE Ø 23,8
				→ 8N-2-014300; für Linkslenker; - ESP		24.2123-1709.3	010503	Ø 23,8
AUDI - TT Roadster (FV9, FVR) 11/14→								
 Hauptbremszylinder								
1.8 TFSI	132	07/15→08/18		für Linkslenker		24.4123-1719.3	011017	TRW Ø 23,8 ohne Bremsflüssigkeitsbehälter
2.0 TDI	135	11/14→						
2.0 TDI quattro	135	01/17→						
2.0 TFSI	169	11/14→						
2.0 TFSI quattro	162 - 169	11/14→						
2.0 TTS quattro	210 - 228	11/14→						
40 TFSI	145	07/18→						
45 TFSI	180	07/18→						
45 TFSI quattro	180	07/18→						
TTS quattro	235	11/20→						
BMW - 1 (E81) 09/06→09/12								
 Bremskraftverstärker								
116 d →	66	01/11→12/11		für Fahrzeuge ohne Start-Stopp-Funktion		03.7848-4003.4	300235	ATE Ø 8" pneumatisch











	kw			 	! #		
BMW - 1 (E81) 09/06→09/12							
 Bremskraftverstärker							
118 i	95 - 100	09/06→12/11		für Fahrzeuge ohne Start-Stopp-Funktion		03.7848-4003.4 300235	ATE Ø 8" pneumatisch
116 d	85	11/08→12/11		09/09→ 05/11; für Fahrzeuge ohne Start-Stopp-Funktion		03.7848-4003.4 300235	ATE Ø 8" pneumatisch
				03/09→ 08/09		03.7848-4003.4 300235	ATE Ø 8" pneumatisch
116 i 120 d	85 120	09/07→12/11 03/07→12/11				03.7848-4003.4 300235	ATE Ø 8" pneumatisch
116 i	90	03/07→12/11		09/07→ 12/08		03.7848-4003.4 300235	ATE Ø 8" pneumatisch
116 i	90	11/08→12/11		09/09→ 05/11; für Fahrzeuge ohne Start-Stopp-Funktion		03.7848-4003.4 300235	ATE Ø 8" pneumatisch
				01/09→ 08/09		03.7848-4003.4 300235	ATE Ø 8" pneumatisch
118 d	100 - 105	09/06→12/11		09/09→ 05/11; für Fahrzeuge ohne Start-Stopp-Funktion		03.7848-4003.4 300235	ATE Ø 8" pneumatisch
118 i 120 i	105 120 - 125	09/06→12/11 03/07→09/12		04/07→ 08/09		03.7848-4003.4 300235	ATE Ø 8" pneumatisch
120 d	130 - 145	03/07→12/11		09/09→ 05/11; für Fahrzeuge ohne Start-Stopp-Funktion		03.7848-4003.4 300235	ATE Ø 8" pneumatisch
				→ 08/09		03.7848-4003.4 300235	ATE Ø 8" pneumatisch
120 i	115	03/07→12/11		→ 03/07		03.7848-4003.4 300235	ATE Ø 8" pneumatisch
123 d	150	03/07→12/11		09/09→ 05/11; für Fahrzeuge ohne Start-Stopp-Funktion		03.7848-5003.4 300236	ATE Ø 8" pneumatisch
				10/07→ 08/09		03.7848-5003.4 300236	ATE Ø 8" pneumatisch
130 i	190 - 195	09/06→12/11		→ 05/11		03.7848-5003.4 300236	ATE Ø 8" pneumatisch
 Hauptbremszylinder							
116 d 116 i 118 i	66 85 95 - 100	01/11→12/11 09/07→12/11 09/06→12/11		für Linkslenker		03.2023-2407.3 010796	ATE Ø1 23,8 Ø2 22,2
120 d	120	03/07→12/11					
116 d	85	11/08→12/11		03/09→ 05/11; für Linkslenker		03.2023-2407.3 010796	ATE Ø1 23,8 Ø2 22,2
116 i	90	03/07→12/11		09/07→ 12/08; für Linkslenker		03.2023-2407.3 010796	ATE Ø1 23,8 Ø2 22,2
116 i	90	11/08→12/11		01/09→ 05/11; für Linkslenker		03.2023-2407.3 010796	ATE Ø1 23,8 Ø2 22,2
118 d	100 - 105	09/06→12/11		04/07→ 05/11; für Linkslenker		03.2023-2407.3 010796	ATE Ø1 23,8 Ø2 22,2
118 i 120 i	105 120 - 125	09/06→12/11 03/07→09/12					
120 d	130 - 145	03/07→12/11		→ 05/11; für Linkslenker		03.2023-2407.3 010796	ATE Ø1 23,8 Ø2 22,2
120 i	115	03/07→12/11		→ 03/07; für Linkslenker		03.2023-2407.3 010796	ATE Ø1 23,8 Ø2 22,2
123 d	150	03/07→12/11		10/07→ 05/11; für Linkslenker		03.2025-1904.3 010797	ATE Ø1 25,4 Ø2 22,2
130 i	190 - 195	09/06→12/11		→ 05/11; für Linkslenker		03.2025-1904.3 010797	ATE Ø1 25,4 Ø2 22,2
Hydraulikaggregat, Bremsanlage							
116 d	66	01/11→12/11				24.9145-0003.2 399007	
116 d	85	11/08→12/11		03/09→ 05/11		24.9145-0003.2 399007	
116 i	90	03/07→12/11		09/08→ 12/08		24.9145-0003.2 399007	
116 i	90	11/08→12/11		01/09→ 05/11		24.9145-0003.2 399007	
118 d	100 - 105	09/06→12/11		09/08→ 05/11		24.9145-0003.2 399007	
118 i 120 d	105 130 - 145	09/06→12/11 03/07→12/11					
120 i	120 - 125	03/07→09/12					
118 i	100	09/06→12/11		09/08→		24.9145-0003.2 399007	
123 d	150	03/07→12/11		09/08→ 05/11; für Fahrzeuge ohne Aktivlenkung		24.9145-0003.2 399007	
BMW - 1 (E87) 02/03→01/13							
 Bremskraftverstärker							
116 d	66	01/11→12/11		für Fahrzeuge ohne Start-Stopp-Funktion		03.7848-4003.4 300235	ATE Ø 8" pneumatisch
116 d 116 i 120 d	85 90 130	03/09→06/11 01/09→06/11 03/07→06/11		09/09→ 05/11; für Fahrzeuge ohne Start-Stopp-Funktion		03.7848-4003.4 300235	ATE Ø 8" pneumatisch
				→ 08/09		03.7848-4003.4 300235	ATE Ø 8" pneumatisch
116 i	85	06/04→06/11		09/04→ 08/07		03.7848-4003.4 300235	ATE Ø 8" pneumatisch
116 i	90	09/07→06/11		→ 12/08		03.7848-4003.4 300235	ATE Ø 8" pneumatisch
→							











	kw			 	! #		
BMW - 1 (E87) 02/03→01/13							
 Bremskraftverstärker							
118 d 118 i 120 d 120 i	90 95 110 110	06/04→02/07 07/04→02/07 06/04→02/07 06/04→02/07		09/04→		03.7848-4003.4 300235	ATE Ø 8" pneumatisch
118 d 118 i 120 i	100 - 105 105 120 - 125	03/07→06/11 09/06→06/11 03/07→06/11		09/09→ 05/11; für Fahrzeuge ohne Start-Stopp-Funktion 04/07→ 08/09		03.7848-4003.4 300235	ATE Ø 8" pneumatisch
118 i 120 i	100 115	10/06→06/11 03/07→06/11		→ 03/07		03.7848-4003.4 300235	ATE Ø 8" pneumatisch
118 i	125	03/07→12/07		04/07→		03.7848-4003.4 300235	ATE Ø 8" pneumatisch
120 d	120	06/04→06/11		09/04→ 02/07		03.7848-4003.4 300235	ATE Ø 8" pneumatisch
123 d	150	03/07→06/11		09/09→ 05/11; für Fahrzeuge ohne Start-Stopp-Funktion 10/07→ 08/09		03.7848-5003.4 300236	ATE Ø 8" pneumatisch
130 i	190	03/07→06/11		→ 05/11		03.7848-5003.4 300236	ATE Ø 8" pneumatisch
130 i	195	09/05→02/07				03.7848-5003.4 300236	ATE Ø 8" pneumatisch
 Hauptbremszylinder							
116 d	66	01/11→12/11		für Linkslenker		03.2023-2407.3 010796	ATE Ø1 23,8 Ø2 22,2
116 d 116 i 120 d	85 90 130	03/09→06/11 01/09→06/11 03/07→06/11		→ 05/11; für Linkslenker		03.2023-2407.3 010796	ATE Ø1 23,8 Ø2 22,2
116 i	85	06/04→06/11		09/04→ 08/07; für Linkslenker		03.2023-2407.3 010796	ATE Ø1 23,8 Ø2 22,2
116 i	90	09/07→06/11		→ 12/08; für Linkslenker		03.2023-2407.3 010796	ATE Ø1 23,8 Ø2 22,2
118 d 118 i 120 d 120 i	90 95 110 110	06/04→02/07 07/04→02/07 06/04→02/07 06/04→02/07		09/04→; für Linkslenker		03.2023-2407.3 010796	ATE Ø1 23,8 Ø2 22,2
118 d 118 i 120 i	100 - 105 105 120 - 125	03/07→06/11 09/06→06/11 03/07→06/11		04/07→ 05/11; für Linkslenker		03.2023-2407.3 010796	ATE Ø1 23,8 Ø2 22,2
118 i 120 i	100 115	10/06→06/11 03/07→06/11		→ 03/07; für Linkslenker		03.2023-2407.3 010796	ATE Ø1 23,8 Ø2 22,2
118 i	125	03/07→12/07		04/07→; für Linkslenker		03.2023-2407.3 010796	ATE Ø1 23,8 Ø2 22,2
120 d	120	06/04→06/11		09/04→ 02/07; für Linkslenker		03.2023-2407.3 010796	ATE Ø1 23,8 Ø2 22,2
123 d	150	03/07→06/11		10/07→ 05/11; für Linkslenker		03.2025-1904.3 010797	ATE Ø1 25,4 Ø2 22,2
130 i	190	03/07→06/11		→ 05/11; für Linkslenker		03.2025-1904.3 010797	ATE Ø1 25,4 Ø2 22,2
130 i	195	09/05→02/07		für Linkslenker		03.2025-1904.3 010797	ATE Ø1 25,4 Ø2 22,2
Hydraulikaggregat, Bremsanlage							
116 d	66	01/11→12/11				24.9145-0003.2 399007	
116 d 116 i	85 90	03/09→06/11 01/09→06/11		→ 05/11		24.9145-0003.2 399007	
116 i	90	09/07→06/11		09/08→ 12/08		24.9145-0003.2 399007	
118 d 118 i 120 d 120 i	100 - 105 105 130 120 - 125	03/07→06/11 09/06→06/11 03/07→06/11 03/07→06/11		09/08→ 05/11		24.9145-0003.2 399007	
123 d	150	03/07→06/11		09/08→ 05/11; für Fahrzeuge ohne Aktivlenkung		24.9145-0003.2 399007	
BMW - 1 (F20) 07/11→06/19							
 Hauptbremszylinder							
114 d 116 d 116 i 118 d	70 85 100 100 - 105	11/12→06/19 07/11→02/15 07/11→02/15 07/11→06/19		für Linkslenker		24.4123-1736.3 011118	Ø 23,8 ohne Bremsflüssigkeitsbehälter
118 i 120 d	125 120 - 147	07/11→02/15 07/11→06/19					
114 i	75	07/12→02/15		09/12→; für Linkslenker		24.4123-1736.3 011118	Ø 23,8 ohne Bremsflüssigkeitsbehälter
116 d 116 i 118 d 118 i	85 80 110 100	03/15→06/19 03/15→06/19 03/15→06/19 03/15→06/19		für Linkslenker; - Performance Parts		24.4123-1736.3 011118	Ø 23,8 ohne Bremsflüssigkeitsbehälter
→							











	kw			 	! #		
BMW - 1 (F20) 07/11→06/19							
 Hauptbremszylinder							
120 d	140 - 151	03/15→06/19		für Linkslenker; + Performance Parts		24.4125-1713.3 011109	Ø 25,4 ohne Bremsflüssigkeitsbehälter
120 d xDrive	140 - 151	03/15→06/19					
120 i	130 - 135	03/15→06/19					
118 d xDrive	105 - 110	07/13→06/19		für Fahrzeuge ohne Start-Stopp-Funktion		24.4123-1736.3 011118	Ø 23,8 ohne Bremsflüssigkeitsbehälter
120 d xDrive	135 - 147	11/12→02/15		für Fahrzeuge mit Start-Stopp-Funktion		24.4125-1713.3 011109	Ø 25,4 ohne Bremsflüssigkeitsbehälter
125 d	155 - 165	03/12→06/19		für Linkslenker		24.4125-1713.3 011109	Ø 25,4 ohne Bremsflüssigkeitsbehälter
125 i	160 - 175	03/12→06/19					
M 135 i	240	03/15→06/16					
M 140 i	250	07/16→06/19					
M 140 i xDrive	250	07/16→06/19					
M 135 i	235	07/12→02/15		09/12→; für Linkslenker		24.4125-1713.3 011109	Ø 25,4 ohne Bremsflüssigkeitsbehälter
M 135 i xDrive	235 - 240	11/12→06/16				24.4125-1713.3 011109	Ø 25,4 ohne Bremsflüssigkeitsbehälter
BMW - 1 (F21) 12/11→12/19							
 Hauptbremszylinder							
114 d	70	06/15→05/19		für Linkslenker		24.4123-1736.3 011118	Ø 23,8 ohne Bremsflüssigkeitsbehälter
116 d	85	12/11→02/15					
116 i	100	12/11→02/15					
118 d	100 - 105	12/11→06/19					
118 i	125	07/12→06/19					
120 d	120 - 147	01/12→06/19					
114 d	70	07/12→05/19		10/12→; für Linkslenker		24.4123-1736.3 011118	Ø 23,8 ohne Bremsflüssigkeitsbehälter
114 i	75	07/12→01/15		09/12→; für Linkslenker		24.4123-1736.3 011118	Ø 23,8 ohne Bremsflüssigkeitsbehälter
116 d	85	03/15→05/19		für Linkslenker; - Performance Parts		24.4123-1736.3 011118	Ø 23,8 ohne Bremsflüssigkeitsbehälter
116 i	80	03/15→06/19					
118 d	110	03/15→06/19					
118 d xDrive	110	03/15→05/19		für Linkslenker; + Performance Parts		24.4125-1713.3 011109	Ø 25,4 ohne Bremsflüssigkeitsbehälter
118 i	100	03/15→06/19					
120 d	140 - 151	03/15→06/19					
120 d xDrive	140 - 151	03/15→06/19					
120 i	130 - 135	03/15→06/19					
118 d xDrive	105	05/13→02/15		für Fahrzeuge ohne Start-Stopp-Funktion		24.4123-1736.3 011118	Ø 23,8 ohne Bremsflüssigkeitsbehälter
				für Fahrzeuge mit Start-Stopp-Funktion		24.4125-1713.3 011109	Ø 25,4 ohne Bremsflüssigkeitsbehälter
120 d xDrive	135 - 147	01/12→02/15		07/12→; für Fahrzeuge ohne Start-Stopp-Funktion		24.4123-1736.3 011118	Ø 23,8 ohne Bremsflüssigkeitsbehälter
				07/12→; für Fahrzeuge mit Start-Stopp-Funktion		24.4125-1713.3 011109	Ø 25,4 ohne Bremsflüssigkeitsbehälter
125 d	155 - 160	12/11→05/19		03/12→; für Linkslenker		24.4125-1713.3 011109	Ø 25,4 ohne Bremsflüssigkeitsbehälter
125 i	160	12/11→12/19					
125 d	165	03/15→05/19		für Linkslenker		24.4125-1713.3 011109	Ø 25,4 ohne Bremsflüssigkeitsbehälter
125 i	165 - 175	03/13→06/19					
M 135 i	240	03/15→06/16					
M 140 i	250	10/15→06/19					
M 140 i xDrive	250	09/15→06/19					
M 135 i	235	12/11→06/16		09/12→; für Linkslenker		24.4125-1713.3 011109	Ø 25,4 ohne Bremsflüssigkeitsbehälter
M 135 i xDrive	235	02/12→06/16		07/12→		24.4125-1713.3 011109	Ø 25,4 ohne Bremsflüssigkeitsbehälter
M 135 i xDrive	240	03/15→06/16				24.4125-1713.3 011109	Ø 25,4 ohne Bremsflüssigkeitsbehälter
BMW - 1 (F40) 07/19→							
 Hauptbremszylinder							
116 d	85	07/19→		für Fahrzeuge ohne M-Sportbremse		24.4122-1722.3 011085	Ø 22,2 ohne Bremsflüssigkeitsbehälter
116 i	80	11/20→					
→							









	kw				! #		
BMW - 1 (F40) 07/19→							
 Hauptbremszylinder							
118 d	100 - 110	07/19→		für Fahrzeuge mit M-Sportbremse	24.4123-1733.3	011108	Ø 23,8 ohne Bremsflüssigkeitsbehälter
118 i	100 - 103	07/19→					
120 d	140	03/20→			24.4123-1733.3	011108	Ø 23,8 ohne Bremsflüssigkeitsbehälter
120 d xDrive	140	07/19→					
120 i	131	11/20→					
128 ti	180 - 195	11/20→					
BMW - 1 (F52) 01/17→							
 Hauptbremszylinder							
118 i	100	01/17→08/19		für Fahrzeuge ohne M-Sportbremse	24.4122-1722.3	011085	Ø 22,2 ohne Bremsflüssigkeitsbehälter
				für Fahrzeuge mit M-Sportbremse	24.4123-1733.3	011108	Ø 23,8 ohne Bremsflüssigkeitsbehälter
BMW - 1 Cabriolet (E88) 12/07→12/13							
 Bremskraftverstärker							
118 d	100 - 105	09/08→12/13		→ 10/13; für Fahrzeuge ohne Start-Stopp-Funktion	03.7848-4003.4	300235	ATE Ø 8" pneumatisch
118 i	100	09/08→12/13					
120 d	120 - 145	03/08→12/13					
120 i	115 - 120	03/08→12/13					
118 i	105	03/08→10/13		für Fahrzeuge ohne Start-Stopp-Funktion	03.7848-4003.4	300235	ATE Ø 8" pneumatisch
120 i	125	12/07→10/13					
128 i	172	12/07→10/13					
123 d	150	09/08→12/13		→ 10/13; für Fahrzeuge ohne Start-Stopp-Funktion	03.7848-5003.4	300236	ATE Ø 8" pneumatisch
125 i	160	12/07→10/13			03.7848-4003.4	300235	ATE Ø 8" pneumatisch
135 i	225	03/08→10/13			03.7845-0103.4	300268	ATE Ø 8" pneumatisch
135 i	240	03/08→12/13		→ 10/13	03.7845-0103.4	300268	ATE Ø 8" pneumatisch
 Hauptbremszylinder							
118 d	100 - 105	09/08→12/13		→ 10/13; für Linkslenker	03.2023-2407.3	010796	ATE Ø1 23,8 Ø2 22,2
118 i	100	09/08→12/13					
120 d	120 - 145	03/08→12/13					
120 i	115 - 120	03/08→12/13					
118 i	105	03/08→10/13		für Linkslenker	03.2023-2407.3	010796	ATE Ø1 23,8 Ø2 22,2
120 i	125	12/07→10/13					
125 i	160	12/07→10/13					
128 i	172	12/07→10/13					
123 d	150	09/08→12/13		→ 10/13; für Linkslenker	03.2025-1904.3	010797	ATE Ø1 25,4 Ø2 22,2
135 i	240	03/08→12/13					
135 i	225	03/08→10/13		für Linkslenker	03.2025-1904.3	010797	ATE Ø1 25,4 Ø2 22,2
Hydraulikaggregat, Bremsanlage							
118 d	100 - 105	09/08→12/13		→ 10/13	24.9145-0003.2	399007	
118 i	100	09/08→12/13					
118 i	105	03/08→10/13		09/08→	24.9145-0003.2	399007	
120 d	120 - 145	03/08→12/13		09/08→ 10/13; für Fahrzeuge ohne Aktivlenkung	24.9145-0003.2	399007	
120 i	115 - 120	03/08→12/13					
120 i	125	12/07→10/13		09/08→; für Fahrzeuge ohne Aktivlenkung	24.9145-0003.2	399007	
123 d	150	09/08→12/13		→ 10/13; für Fahrzeuge ohne Aktivlenkung	24.9145-0003.2	399007	
BMW - 1 Coupe (E82) 10/06→10/13							
 Bremskraftverstärker							
118 d	100 - 105	09/09→10/13		für Fahrzeuge ohne Start-Stopp-Funktion	03.7848-4003.4	300235	ATE Ø 8" pneumatisch
120 d	120 - 130	09/07→10/13					
120 i	115	09/09→10/13					
120 d	145	09/07→10/13		10/07→; für Fahrzeuge ohne Start-Stopp-Funktion	03.7848-4003.4	300235	ATE Ø 8" pneumatisch
→							













	kw			 	! #		
BMW - 1 Coupe (E82) 10/06→10/13							
 Bremskraftverstärker							
120 i	125	10/07→10/13		09/09→; für Fahrzeuge ohne Start-Stopp-Funktion		03.7848-4003.4 300235	ATE Ø 8" pneumatisch
123 d	150	10/07→09/13		→ 08/09		03.7848-4003.4 300235	ATE Ø 8" pneumatisch
				09/09→; für Fahrzeuge ohne Start-Stopp-Funktion		03.7848-5003.4 300236	ATE Ø 8" pneumatisch
125 i	160	03/08→10/13				03.7848-4003.4 300235	ATE Ø 8" pneumatisch
128 i	172	10/07→10/13					
135 i	225 - 240	10/07→10/13				03.7845-0103.4 300268	ATE Ø 8" pneumatisch
 Hauptbremszylinder							
118 d	100 - 105	09/09→10/13		für Linkslenker		03.2023-2407.3 010796	ATE Ø1 23,8 Ø2 22,2
120 d	120 - 130	09/07→10/13					
120 i	115	09/09→10/13					
125 i	160	03/08→10/13					
128 i	172	10/07→10/13					
120 d	145	09/07→10/13		10/07→; für Linkslenker		03.2023-2407.3 010796	ATE Ø1 23,8 Ø2 22,2
120 i	125	10/07→10/13		09/09→; für Linkslenker		03.2023-2407.3 010796	ATE Ø1 23,8 Ø2 22,2
123 d	150	10/07→09/13		für Linkslenker		03.2025-1904.3 010797	ATE Ø1 25,4 Ø2 22,2
135 i	225 - 240	10/07→10/13					
Hydraulikaggregat, Bremsanlage							
118 d	100 - 105	09/09→10/13				24.9145-0003.2 399007	
120 d	120 - 145	09/07→10/13		09/08→; für Fahrzeuge ohne Aktivlenkung		24.9145-0003.2 399007	
123 d	150	10/07→09/13					
120 i	115	09/09→10/13		für Fahrzeuge ohne Aktivlenkung		24.9145-0003.2 399007	
120 i	125	10/07→10/13		09/09→; für Fahrzeuge ohne Aktivlenkung		24.9145-0003.2 399007	
BMW - 1 Van (F20) 03/15→06/19							
 Hauptbremszylinder							
118 d	110	03/15→06/19		für Linkslenker; - Performance Parts		24.4123-1736.3 011118	Ø 23,8 ohne Bremsflüssigkeitsbehälter
118 i	100	07/15→06/19					
120 d	140	03/15→06/19		für Linkslenker; + Performance Parts		24.4125-1713.3 011109	Ø 25,4 ohne Bremsflüssigkeitsbehälter
120 i	135	07/16→06/19					
M 140 i	250	07/16→06/19		für Linkslenker		24.4125-1713.3 011109	Ø 25,4 ohne Bremsflüssigkeitsbehälter
BMW - 2 Active Tourer (F45) 11/13→10/21							
 Hauptbremszylinder							
214 d	70	07/14→02/18		03/15→		24.4122-1722.3 011085	Ø 22,2 ohne Bremsflüssigkeitsbehälter
216 d	85	03/14→10/21		10/14→		24.4122-1722.3 011085	Ø 22,2 ohne Bremsflüssigkeitsbehälter
218 i	100	07/14→10/21					
220 d xDrive	140	03/14→10/21					
220 i	141	03/14→10/21					
216 i	75	02/15→02/18		11/15→		24.4122-1722.3 011085	Ø 22,2 ohne Bremsflüssigkeitsbehälter
218 d xDrive	100 - 110	12/14→10/21					
216 i	80	03/18→10/21				24.4122-1722.3 011085	Ø 22,2 ohne Bremsflüssigkeitsbehälter
218 d	110	11/13→10/21					
220 d	140	03/14→10/21					
220 i	131	11/20→10/21					
218 d	100	11/13→10/21		09/14→		24.4122-1722.3 011085	Ø 22,2 ohne Bremsflüssigkeitsbehälter
218 i	103	03/18→10/21				24.4123-1733.3 011108	Ø 23,8 ohne Bremsflüssigkeitsbehälter
225 xe Plug-in-Hybrid	162	11/20→10/21					
220 d	120	03/14→10/21		11/14→		24.4122-1722.3 011085	Ø 22,2 ohne Bremsflüssigkeitsbehälter
220 d xDrive	120	03/14→10/21					
220 i	120	03/14→10/21					
225 i	170	11/13→12/19		10/14→		24.4123-1733.3 011108	Ø 23,8 ohne Bremsflüssigkeitsbehälter
225 i xDrive	170	03/14→10/21					
225 xe Plug-in-Hybrid	165	11/14→10/21		03/16→		24.4123-1733.3 011108	Ø 23,8 ohne Bremsflüssigkeitsbehälter











	kw			 	! #		
BMW - 2 Active Tourer Van (F45) 11/13→10/21							
 Hauptbremszylinder							
218 d 220 d	110 140	07/14→10/21 11/14→10/21				24.4122-1722.3 011085	Ø 22,2 ohne Bremsflüssigkeitsbehälter
218 i	103	03/18→10/21				24.4123-1733.3 011108	Ø 23,8 ohne Bremsflüssigkeitsbehälter
BMW - 2 Cabriolet (F23) 03/14→06/21							
 Hauptbremszylinder							
218 d	100 - 110	07/15→09/20		für Linkslenker; - Performance Parts		24.4123-1736.3 011118	Ø 23,8 ohne Bremsflüssigkeitsbehälter
218 i 220 i 225 i 230 i	100 135 135 185	03/15→06/21 09/15→06/21 10/17→06/21 07/16→06/21		für Linkslenker; + Performance Parts		24.4125-1713.3 011109	Ø 25,4 ohne Bremsflüssigkeitsbehälter
220 d	120 - 151	03/14→09/20		11/14→; für Linkslenker		24.4125-1713.3 011109	Ø 25,4 ohne Bremsflüssigkeitsbehälter
220 i	135	04/14→06/21		11/14→; für Linkslenker; - Performance Parts		24.4123-1736.3 011118	Ø 23,8 ohne Bremsflüssigkeitsbehälter
				11/14→; für Linkslenker; + Performance Parts		24.4125-1713.3 011109	Ø 25,4 ohne Bremsflüssigkeitsbehälter
225 d 228 i M 235 i M 235 i xDrive M 240 i M 240 i xDrive	165 180 240 240 250 250	07/15→05/19 11/14→06/16 11/14→06/16 07/15→06/16 09/15→06/21 09/15→06/21		für Linkslenker		24.4125-1713.3 011109	Ø 25,4 ohne Bremsflüssigkeitsbehälter
BMW - 2 Coupe (F22, F87) 10/12→06/21							
 Hauptbremszylinder							
218 d	100	03/14→09/20		07/15→; für Linkslenker; - Performance Parts		24.4123-1736.3 011118	Ø 23,8 ohne Bremsflüssigkeitsbehälter
				07/15→; für Linkslenker; + Performance Parts		24.4125-1713.3 011109	Ø 25,4 ohne Bremsflüssigkeitsbehälter
218 d 218 i 220 d	105 - 110 100	03/14→09/20 03/15→06/21		für Linkslenker; - Performance Parts		24.4123-1736.3 011118	Ø 23,8 ohne Bremsflüssigkeitsbehälter
220 i 225 i 230 i	120 - 135 135 135 185	10/13→09/20 10/13→06/21 10/17→06/21 07/16→06/21		für Linkslenker; + Performance Parts		24.4125-1713.3 011109	Ø 25,4 ohne Bremsflüssigkeitsbehälter
220 d	140 - 151	03/14→09/20		11/14→; für Linkslenker		24.4125-1713.3 011109	Ø 25,4 ohne Bremsflüssigkeitsbehälter
220 d	147	10/12→11/14		10/13→; für Linkslenker; - Performance Parts		24.4123-1736.3 011118	Ø 23,8 ohne Bremsflüssigkeitsbehälter
				10/13→; für Linkslenker; + Performance Parts		24.4125-1713.3 011109	Ø 25,4 ohne Bremsflüssigkeitsbehälter
220 d xDrive 225 d	120 160 - 165	03/15→09/20 01/14→05/19		für Linkslenker		24.4125-1713.3 011109	Ø 25,4 ohne Bremsflüssigkeitsbehälter
228 i M 235 i M 240 i M 240 i xDrive	180 240 250 250	07/14→06/16 10/13→06/16 09/15→06/21 09/15→06/21					
220 d xDrive	140 - 151	06/14→09/20		03/15→; für Linkslenker		24.4125-1713.3 011109	Ø 25,4 ohne Bremsflüssigkeitsbehälter
M 235 i xDrive	240	07/14→06/16				24.4125-1713.3 011109	Ø 25,4 ohne Bremsflüssigkeitsbehälter
BMW - 2 Gran Coupe (F44) 11/19→							
 Hauptbremszylinder							
216 d 218 i	85 100 - 103	03/20→ 11/19→		für Fahrzeuge ohne M-Sportbremse		24.4122-1722.3 011085	Ø 22,2 ohne Bremsflüssigkeitsbehälter
				für Fahrzeuge mit M-Sportbremse		24.4123-1733.3 011108	Ø 23,8 ohne Bremsflüssigkeitsbehälter
218 d 220 d	100 - 110 120 - 140	11/19→ 11/19→				24.4123-1733.3 011108	Ø 23,8 ohne Bremsflüssigkeitsbehälter
220 d xDrive 220 i 220 i xDrive	140 131 131	07/20→ 11/20→ 03/21→					













	kw					! #		
BMW - 2 Gran Tourer (F46) 07/14→								
 Hauptbremszylinder								
214 d	70	07/15→02/18					24.4122-1722.3 011085	Ø 22,2 ohne Bremsflüssigkeitsbehälter
218 d	110	07/14→						
218 d xDrive	100 - 110	03/15→					24.4123-1733.3 011108	Ø 23,8 ohne Bremsflüssigkeitsbehälter
218 i	100	03/15→						
216 d	85	08/14→			03/15→		24.4122-1722.3 011085	Ø 22,2 ohne Bremsflüssigkeitsbehälter
							24.4123-1733.3 011108	Ø 23,8 ohne Bremsflüssigkeitsbehälter
216 i	75	09/14→02/18			07/15→		24.4122-1722.3 011085	Ø 22,2 ohne Bremsflüssigkeitsbehälter
							24.4123-1733.3 011108	Ø 23,8 ohne Bremsflüssigkeitsbehälter
216 i	80	03/18→					24.4123-1733.3 011108	Ø 23,8 ohne Bremsflüssigkeitsbehälter
220 d	140	09/14→						
220 d xDrive	120 - 140	03/15→						
220 i	120 - 141	03/15→						
218 d	100	07/14→			03/15→		24.4122-1722.3 011085	Ø 22,2 ohne Bremsflüssigkeitsbehälter
							24.4123-1733.3 011108	Ø 23,8 ohne Bremsflüssigkeitsbehälter
218 i	103	04/17→			nicht für Fahrzeuge mit verstärkter Bremse		24.4123-1733.3 011108	Ø 23,8 ohne Bremsflüssigkeitsbehälter
220 d	120	09/14→			07/15→		24.4123-1733.3 011108	Ø 23,8 ohne Bremsflüssigkeitsbehälter
BMW - 2 Gran Tourer Van (F46) 07/14→								
 Hauptbremszylinder								
218 d	110	07/14→					24.4122-1722.3 011085	Ø 22,2 ohne Bremsflüssigkeitsbehälter
							24.4123-1733.3 011108	Ø 23,8 ohne Bremsflüssigkeitsbehälter
218 i	103	03/18→			nicht für Fahrzeuge mit verstärkter Bremse		24.4123-1733.3 011108	Ø 23,8 ohne Bremsflüssigkeitsbehälter
220 d	140	07/14→					24.4123-1733.3 011108	Ø 23,8 ohne Bremsflüssigkeitsbehälter
BMW - 3 (E46) 12/97→05/05								
 Bremskraftverstärker								
316 i	77 - 85	12/98→02/05					03.7860-0702.4 300123	ATE Ø 10" pneumatisch
318 d	85	09/01→02/05						
318 i	87 - 105	12/97→02/05						
320 d	95 - 110	02/98→05/05						
320 i	110 - 125	03/98→02/05						
323 i	120 - 125	03/98→09/00						
325 i	141	09/00→02/05						
325 xi	141	09/00→02/05						
328 i	142	02/98→06/00						
330 d	135 - 150	10/99→02/05						
330 i	170	06/00→02/05						
330 xi	170	06/00→02/05						
330 xd	135	01/00→02/03			06/00→		03.7860-0702.4 300123	ATE Ø 10" pneumatisch
330 xd	150	09/02→12/04			03/03→		03.7860-0702.4 300123	ATE Ø 10" pneumatisch
 Hauptbremszylinder								
316 i	77	12/98→02/05			→ 08/01; - DSC		03.2022-2624.3 010588	Ø1 22,2 Ø2 20,6
320 i	120 - 125	09/00→02/05			02/01→; + DSC		03.2023-2256.3 010870	ATE Ø1 23,8 Ø2 22,2
325 i	141	09/00→02/05			09/01→; - DSC		03.2023-2344.3 010647	ATE Ø1 23,8 Ø2 22,2
316 i	85	02/02→02/05			+ DSC		03.2023-2256.3 010870	ATE Ø1 23,8 Ø2 22,2
318 d	85	09/01→02/05			- DSC		03.2023-2344.3 010647	ATE Ø1 23,8 Ø2 22,2
318 i	100 - 105	09/01→02/05						
320 d	110	09/01→05/05						
318 i	87	12/97→09/01			- DSC		03.2022-2624.3 010588	Ø1 22,2 Ø2 20,6
320 i	110	03/98→09/00						
→								

	kw			 	! #		
BMW - 3 (E46) 12/97→05/05							
 Hauptbremszylinder							
323 i	120 - 125	03/98→09/00		- DSC		03.2022-2624.3 010588	Ø1 22,2 Ø2 20,6
328 i	142	02/98→06/00					
320 d	95 - 100	02/98→09/01		- DSC		03.2022-2624.3 010588	Ø1 22,2 Ø2 20,6
				02/01→; + DSC		03.2023-2256.3 010870	ATE Ø1 23,8 Ø2 22,2
330 d	135	10/99→02/05		→ 08/00; + DSC		03.2023-2204.3 010644	ATE Ø1 23,8 Ø2 22,2
330 i	170	06/00→02/05		02/01→; + DSC		03.2023-2256.3 010870	ATE Ø1 23,8 Ø2 22,2
				→ 08/01; - DSC		03.2023-2304.3 010646	ATE Ø1 23,8 Ø2 22,2
				09/01→; - DSC		03.2023-2344.3 010647	ATE Ø1 23,8 Ø2 22,2
330 d	150	03/03→02/05		+ DSC		03.2023-2256.3 010870	ATE Ø1 23,8 Ø2 22,2
BMW - 3 (E90) 02/04→02/12							
 Bremskraftverstärker							
316 d	85	07/09→12/11		für Fahrzeuge ohne Start-Stopp-Funktion		03.7848-4003.4 300235	ATE Ø 8" pneumatisch
316 i	90	09/07→10/11					
318 d	100	09/07→10/11					
318 i	95 - 105	09/05→10/11					
320 i	110 - 125	12/04→10/11					
316 i	85	09/05→10/11		→ 08/07; für Fahrzeuge ohne Start-Stopp-Funktion		03.7848-4003.4 300235	ATE Ø 8" pneumatisch
320 i	115	02/07→12/11					
318 d	90	03/05→08/07		09/05→; für Fahrzeuge ohne Start-Stopp-Funktion		03.7848-4003.4 300235	ATE Ø 8" pneumatisch
318 d	105	02/07→10/11		09/07→; für Fahrzeuge ohne Start-Stopp-Funktion		03.7848-4003.4 300235	ATE Ø 8" pneumatisch
320 i	120	03/07→12/11					
320 d	110 - 115	12/04→09/07		09/05→; für Fahrzeuge ohne Start-Stopp-Funktion		03.7845-0103.4 300268	ATE Ø 8" pneumatisch
320 d	120	12/04→10/11				03.7848-5003.4 300236	ATE Ø 8" pneumatisch
320 si	127	09/05→08/06					
323 i	130 - 140	09/05→12/11					
325 d	145 - 150	09/06→10/11					
325 i	155 - 160	12/04→12/11					
325 xi	160	09/05→08/06					
328 i	172	09/06→12/11					
330 d	155 - 170	09/05→12/11					
330 i	190	12/04→10/11					
330 i xDrive	200	09/08→10/11					
330 xd	170	09/05→08/08					
330 xi	190 - 200	09/05→08/08					
320 d	130 - 135	09/07→10/11		für Fahrzeuge ohne Start-Stopp-Funktion		03.7845-0103.4 300268	ATE Ø 8" pneumatisch
320 d xDrive	120 - 135	09/08→10/11					
335 d	210	09/06→12/11					
335 i	225	09/06→12/11					
335 i xDrive	224 - 240	05/08→10/11					
335 xi	225 - 240	09/06→08/08					
325 i xDrive	155 - 160	09/08→10/11		Motorcode: N53		03.7848-5003.4 300236	ATE Ø 8" pneumatisch
325 xi	160	09/05→08/08		→ 08/07; Motorcode: N52N; für Fahrzeuge ohne Start-Stopp-Funktion		03.7845-0103.4 300268	ATE Ø 8" pneumatisch
				→ 08/07; Motorcode: N52		03.7848-5003.4 300236	ATE Ø 8" pneumatisch
				09/07→; Motorcode: N53		03.7848-5003.4 300236	ATE Ø 8" pneumatisch
325 xi	160	09/07→08/08		Motorcode: N52N; für Fahrzeuge ohne Start-Stopp-Funktion		03.7845-0103.4 300268	ATE Ø 8" pneumatisch
				Motorcode: N53		03.7848-5003.4 300236	ATE Ø 8" pneumatisch
330 d	180	09/08→10/11		→ 08/09; für Fahrzeuge ohne Start-Stopp-Funktion		03.7845-0103.4 300268	ATE Ø 8" pneumatisch
330 d xDrive	180	09/08→10/11					
330 i	200	03/07→12/11		09/09→		03.7848-5003.4 300236	ATE Ø 8" pneumatisch
335 i	220 - 240	03/06→12/11		09/06→; für Fahrzeuge ohne Start-Stopp-Funktion		03.7845-0103.4 300268	ATE Ø 8" pneumatisch
335 xi	224	09/06→06/08		03/07→; für Fahrzeuge ohne Start-Stopp-Funktion		03.7845-0103.4 300268	ATE Ø 8" pneumatisch
 Hauptbremszylinder							
316 d	85	07/09→12/11		für Linkslenker		03.2023-2407.3 010796	ATE Ø1 23,8 Ø2 22,2
316 i	90	09/07→10/11					
→							













	kw			 	! #		
BMW - 3 (E90) 02/04→02/12							
 Hauptbremszylinder							
318 d 318 i	100 95 - 105	09/07→10/11 09/05→10/11		für Linkslenker		03.2023-2407.3 010796	ATE Ø1 23,8 Ø2 22,2
320 i	110 - 125	12/04→12/11					
316 i 320 i	85 115	09/05→10/11 02/07→12/11		→ 08/07; für Linkslenker		03.2023-2407.3 010796	ATE Ø1 23,8 Ø2 22,2
318 d	90	03/05→08/07		09/05→; für Linkslenker		03.2023-2407.3 010796	ATE Ø1 23,8 Ø2 22,2
318 d	105	02/07→10/11		09/07→; für Linkslenker		03.2023-2407.3 010796	ATE Ø1 23,8 Ø2 22,2
320 d	110 - 115	12/04→09/07		09/05→; für Linkslenker		03.2025-1904.3 010797	ATE Ø1 25,4 Ø2 22,2
320 d 320 si 323 i 325 i 328 i 330 d 330 i 335 i	120 - 135 127 130 - 140 155 - 160 172 180 190 - 200 225	12/04→10/11 09/05→08/06 09/05→12/11 12/04→12/11 09/06→12/11 09/08→10/11 12/04→12/11 09/06→12/11		für Linkslenker		03.2025-1904.3 010797	ATE Ø1 25,4 Ø2 22,2
320 d xDrive 325 d 325 i xDrive 325 xi 330 d 330 d xDrive 330 i xDrive 330 xd 330 xi 335 d 335 i xDrive 335 xi	120 - 135 145 - 150 155 - 160 160 155 - 170 180 200 170 190 - 200 210 224 - 240 224 - 225	09/08→10/11 09/06→10/11 09/08→10/11 09/05→08/08 09/05→12/11 09/08→10/11 09/08→10/11 09/05→08/08 09/05→08/08 09/06→12/11 05/08→10/11 09/06→08/08				03.2025-1904.3 010797	ATE Ø1 25,4 Ø2 22,2
335 i	220 - 240	03/06→12/11		09/06→; für Linkslenker		03.2025-1904.3 010797	ATE Ø1 25,4 Ø2 22,2
335 xi	240	09/06→06/08		03/07→		03.2025-1904.3 010797	ATE Ø1 25,4 Ø2 22,2
Hydraulikaggregat, Bremsanlage							
316 d	85	07/09→12/11				24.9145-0003.2 399007	
316 i 318 d	90 100 - 105	09/07→10/11 02/07→10/11		09/08→		24.9145-0003.2 399007	
318 i	100 - 105	09/07→10/11					
320 d 320 i	120 - 130 120 - 125	12/04→10/11 03/07→12/11		09/08→; für Fahrzeuge ohne Aktivlenkung		24.9145-0003.2 399007	
320 d	135	03/10→10/11		für Fahrzeuge ohne Aktivlenkung		24.9145-0003.2 399007	
BMW - 3 (F30, F80) 11/11→10/18							
 Hauptbremszylinder							
316 d 318 d	85 100 - 110	03/12→10/18 03/12→10/18		für Linkslenker		24.4123-1736.3 011118	Ø 23,8 ohne Bremsflüssigkeitsbehälter
318 d xDrive 320 d xDrive 320 i	110 140 125 - 135	07/15→02/18 07/15→10/18 03/12→10/18					
320 i xDrive	135	07/12→10/18					
316 i	100	07/12→08/16		11/12→; für Linkslenker		24.4123-1736.3 011118	Ø 23,8 ohne Bremsflüssigkeitsbehälter
318 d xDrive 318 i	105 100	07/13→06/15 07/15→10/18		für Linkslenker; - Performance Parts		24.4123-1736.3 011118	Ø 23,8 ohne Bremsflüssigkeitsbehälter
				für Linkslenker; + Performance Parts		24.4125-1713.3 011109	Ø 25,4 ohne Bremsflüssigkeitsbehälter
320 d	120	11/11→10/18		02/12→; für Linkslenker		24.4123-1736.3 011118	Ø 23,8 ohne Bremsflüssigkeitsbehälter
→							









	kw			 	! #		
BMW - 3 (F30, F80) 11/11→10/18							
 Hauptbremszylinder							
320 d	135 - 147	11/11→03/16		02/12→; für Linkslenker		24.4125-1713.3 011109	Ø 25,4 ohne Bremsflüssigkeitsbehälter
328i	160	11/11→06/15					
328 i	180	11/11→10/18					
335 i	225 - 240	11/11→07/15					
320 d	140	07/15→10/18		für Linkslenker; für Fahrzeuge ohne M-Sportbremse		24.4125-1713.3 011109	Ø 25,4 ohne Bremsflüssigkeitsbehälter
320 d xDrive	120 - 147	08/12→10/18		für Linkslenker		24.4125-1713.3 011109	Ø 25,4 ohne Bremsflüssigkeitsbehälter
325 d	165	03/16→02/18					
328 i xDrive	180	07/12→08/16					
330 d	190	07/12→10/18					
330 d xDrive	190	03/13→10/18					
335 d xDrive	230	07/13→10/18					
335 i	250	07/13→07/15					
335 i xDrive	225 - 250	07/12→07/15					
ActiveHybrid	250	07/12→06/15					
325 d	155 - 160	03/13→02/16		04/13→; für Linkslenker		24.4125-1713.3 011109	Ø 25,4 ohne Bremsflüssigkeitsbehälter
330 d	210	07/12→10/18		09/15→; für Linkslenker		24.4125-1713.3 011109	Ø 25,4 ohne Bremsflüssigkeitsbehälter
330 d xDrive	210	03/13→10/18					
330 e	185	11/15→10/18		01/16→; für Linkslenker		24.4125-1713.3 011109	Ø 25,4 ohne Bremsflüssigkeitsbehälter
330 i	185	07/15→10/18		für Linkslenker; - Performance Parts		24.4125-1713.3 011109	Ø 25,4 ohne Bremsflüssigkeitsbehälter
330 i xDrive	185	07/15→10/18					
340 i	240 - 265	07/15→10/18					
340 i xDrive	240 - 265	07/15→10/18					
BMW - 3 Cabriolet (E36) 03/93→11/99							
 Bremskraftverstärker							
318 i	85	03/94→11/99		09/94→; - ASC		03.7760-3102.4 300139	ATE Ø 10" pneumatisch
320 i	110	12/93→11/99		09/96→; + ASC		03.7760-3102.4 300139	ATE Ø 10" pneumatisch
				→ 08/94; - ASC		10.6360-1903.4 300093	ATE Ø 10" pneumatisch
				→ 08/96; + ASC		10.6360-1903.4 300093	ATE Ø 10" pneumatisch
323 i	125	05/95→11/99		09/96→; + ASC		03.7760-3102.4 300139	ATE Ø 10" pneumatisch
328 i	142	01/95→11/99		- ASC		03.7760-3102.4 300139	ATE Ø 10" pneumatisch
				→ 08/96; + ASC		10.6360-1903.4 300093	ATE Ø 10" pneumatisch
Pedalwegsensor, Bremspedal							
318 i	85	03/94→11/99		→ 08/96; + ASC		03.0655-0002.2 370002	ATE
320 i	110	12/93→11/99		→ 08/94; - ASC		03.0655-0002.2 370002	ATE
323 i	125	05/95→11/99		→ 08/96; + ASC		03.0655-0002.2 370002	ATE
328 i	142	01/95→11/99					
 Hauptbremszylinder							
318 i	85	03/94→11/99		→ 08/94; + ASC		10.6123-0239.3 010335	ATE Ø 23,8
320 i	110	12/93→11/99					
323 i	125	05/95→11/99		→ 08/96; + ASC		10.6123-0239.3 010335	ATE Ø 23,8
328 i	142	01/95→11/99					
BMW - 3 Cabriolet (E46) 04/00→12/07							
 Bremskraftverstärker							
318 Ci	100	12/00→08/06		09/01→		03.7860-0702.4 300123	ATE Ø 10" pneumatisch
318 Ci	105	09/01→12/07		→ 09/06		03.7860-0702.4 300123	ATE Ø 10" pneumatisch
320 Cd	110	02/05→12/07					
320 Ci	120 - 125	09/00→12/07					
330 Cd	150	08/05→12/07					
318 Ci	110	03/04→08/06				03.7860-0702.4 300123	ATE Ø 10" pneumatisch
323 Ci	120 - 125	04/00→09/00					
325 Ci	141	09/00→08/06					
330 Ci	170	06/00→08/06					
 Hauptbremszylinder							
318 Ci	100	12/00→08/06		09/01→; + DSC		03.2023-2256.3 010870	ATE Ø1 23,8 Ø2 22,2
				09/01→; - DSC		03.2023-2344.3 010647	ATE Ø1 23,8 Ø2 22,2
318 Ci	105	09/01→12/07		→ 09/06; + DSC		03.2023-2256.3 010870	ATE Ø1 23,8 Ø2 22,2
→							

	kw			 	! #		
BMW - 3 Cabriolet (E46) 04/00→12/07							
 Hauptbremszylinder							
320 Ci	120	01/06→12/07		→ 09/06; - DSC		03.2023-2344.3 010647	ATE Ø1 23,8 Ø2 22,2
318 Ci	110	03/04→08/06				03.2023-2256.3 010870	ATE Ø1 23,8 Ø2 22,2
320 Cd	110	02/05→12/07		→ 09/06		03.2023-2256.3 010870	ATE Ø1 23,8 Ø2 22,2
330 Cd	150	08/05→12/07					
320 Ci	125	09/00→12/07		→ 08/01; - DSC		03.2022-2624.3 010588	Ø1 22,2 Ø2 20,6
				→ 09/06; + DSC		03.2023-2256.3 010870	ATE Ø1 23,8 Ø2 22,2
				09/01→ 09/06; - DSC		03.2023-2344.3 010647	ATE Ø1 23,8 Ø2 22,2
323 Ci	120 - 125	04/00→09/00		- DSC		03.2022-2624.3 010588	Ø1 22,2 Ø2 20,6
325 Ci	141	09/00→08/06		→ 08/01; - DSC		03.2022-2624.3 010588	Ø1 22,2 Ø2 20,6
				+ DSC		03.2023-2256.3 010870	ATE Ø1 23,8 Ø2 22,2
				09/01→; - DSC		03.2023-2344.3 010647	ATE Ø1 23,8 Ø2 22,2
330 Ci	170	06/00→08/06		→ 08/00; + DSC		03.2023-2204.3 010644	ATE Ø1 23,8 Ø2 22,2
				09/00→; + DSC		03.2023-2256.3 010870	ATE Ø1 23,8 Ø2 22,2
				→ 08/01; - DSC		03.2023-2304.3 010646	ATE Ø1 23,8 Ø2 22,2
				09/01→; - DSC		03.2023-2344.3 010647	ATE Ø1 23,8 Ø2 22,2
BMW - 3 Cabriolet (E93) 05/06→12/13							
 Bremskraftverstärker							
318 i	105	03/10→12/13		→ 11/13; für Fahrzeuge ohne Start-Stopp-Funktion		03.7848-4003.4 300235	ATE Ø 8" pneumatisch
320 d	120	01/08→12/13		→ 11/13; für Fahrzeuge ohne Start-Stopp-Funktion		03.7845-0103.4 300268	ATE Ø 8" pneumatisch
320 d	130 - 147	03/08→10/13		für Fahrzeuge ohne Start-Stopp-Funktion		03.7845-0103.4 300268	ATE Ø 8" pneumatisch
320 d	145	09/07→02/10		03/08→; für Fahrzeuge ohne Start-Stopp-Funktion		03.7845-0103.4 300268	ATE Ø 8" pneumatisch
320 i	115 - 120	09/06→10/13		03/07→ 03/08; Motorcode: N43		03.7845-0103.4 300268	ATE Ø 8" pneumatisch
				04/08→; für Fahrzeuge ohne Start-Stopp-Funktion		03.7848-4003.4 300235	ATE Ø 8" pneumatisch
				03/07→ 03/08; Motorcode: N46N		03.7848-5003.4 300236	ATE Ø 8" pneumatisch
320 i	125	03/07→10/13		→ 03/08; Motorcode: N43		03.7845-0103.4 300268	ATE Ø 8" pneumatisch
				04/08→; für Fahrzeuge ohne Start-Stopp-Funktion		03.7848-4003.4 300235	ATE Ø 8" pneumatisch
				→ 03/08; Motorcode: N46N		03.7848-5003.4 300236	ATE Ø 8" pneumatisch
323 i	140	03/07→09/11				03.7845-0103.4 300268	ATE Ø 8" pneumatisch
325 d	145 - 155	03/07→12/10		09/07→		03.7848-5003.4 300236	ATE Ø 8" pneumatisch
325 d	150	09/09→09/13		03/10→		03.7848-5003.4 300236	ATE Ø 8" pneumatisch
325 i	160	12/06→02/10		Motorcode: N52N		03.7845-0103.4 300268	ATE Ø 8" pneumatisch
				Motorcode: N53		03.7848-5003.4 300236	ATE Ø 8" pneumatisch
325 i	155	10/06→12/13		03/07→; Motorcode: N52N; → 11/13		03.7845-0103.4 300268	ATE Ø 8" pneumatisch
				03/07→; Motorcode: N53; → 11/13		03.7848-5003.4 300236	ATE Ø 8" pneumatisch
325 i	160	03/07→12/13		Motorcode: N52N; → 11/13		03.7845-0103.4 300268	ATE Ø 8" pneumatisch
				Motorcode: N53; → 11/13		03.7848-5003.4 300236	ATE Ø 8" pneumatisch
330 d	170	03/07→12/13		→ 08/09		03.7845-0103.4 300268	ATE Ø 8" pneumatisch
				09/09→ 11/13		03.7848-5003.4 300236	ATE Ø 8" pneumatisch
330 d	180	01/09→09/13		→ 08/09		03.7845-0103.4 300268	ATE Ø 8" pneumatisch
				09/09→		03.7848-5003.4 300236	ATE Ø 8" pneumatisch
330 i	190	03/10→10/13				03.7848-5003.4 300236	ATE Ø 8" pneumatisch
330 i	200	03/07→10/13		→ 08/09; Motorcode: N53		03.7845-0103.4 300268	ATE Ø 8" pneumatisch
				Motorcode: N52N		03.7848-5003.4 300236	ATE Ø 8" pneumatisch
				09/09→; Motorcode: N53		03.7848-5003.4 300236	ATE Ø 8" pneumatisch
335 i	225 - 240	05/06→10/13		03/07→		03.7845-0103.4 300268	ATE Ø 8" pneumatisch
 Hauptbremszylinder							
318 i	105	03/10→12/13		→ 11/13		03.2023-2407.3 010796	ATE Ø1 23,8 Ø2 22,2
320 d	120	01/08→12/13		für Linkslenker; → 11/13		03.2025-1904.3 010797	ATE Ø1 25,4 Ø2 22,2
325 i	160	03/07→12/13					
330 d	170	03/07→12/13					
320 d	130 - 147	09/07→10/13		für Linkslenker		03.2025-1904.3 010797	ATE Ø1 25,4 Ø2 22,2
325 i	160	12/06→02/10					
330 d	180	01/09→09/13					
330 i	190 - 200	03/07→10/13					
→							











	kW					! #		
BMW - 3 Cabriolet (E93) 05/06→12/13								
 Hauptbremszylinder								
320 i	115 - 120	09/06→10/13		06/08→; für Linkslenker		03.2023-2407.3 010796	ATE Ø1 23,8 Ø2 22,2	
				03/07→; für Linkslenker; → 05/08		03.2025-1904.3 010797	ATE Ø1 25,4 Ø2 22,2	
320 i	125	03/07→10/13		06/08→; für Linkslenker		03.2023-2407.3 010796	ATE Ø1 23,8 Ø2 22,2	
				für Linkslenker; → 05/08		03.2025-1904.3 010797	ATE Ø1 25,4 Ø2 22,2	
325 d	145 - 155	03/07→12/10		09/07→; für Linkslenker		03.2025-1904.3 010797	ATE Ø1 25,4 Ø2 22,2	
325 d	150	09/09→09/13		03/10→; für Linkslenker		03.2025-1904.3 010797	ATE Ø1 25,4 Ø2 22,2	
325 i	155	10/06→12/13		03/07→; für Linkslenker; → 11/13		03.2025-1904.3 010797	ATE Ø1 25,4 Ø2 22,2	
335 i	225 - 240	05/06→10/13		03/07→; für Linkslenker		03.2025-1904.3 010797	ATE Ø1 25,4 Ø2 22,2	
Hydraulikaggregat, Bremsanlage								
318 i	105	03/10→12/13		→ 11/13		24.9145-0003.2 399007		
320 d	120	01/08→12/13		09/08→ 11/13; für Fahrzeuge ohne Aktivlenkung		24.9145-0003.2 399007		
320 d	130 - 145	09/07→02/10		09/08→; für Fahrzeuge ohne Aktivlenkung		24.9145-0003.2 399007		
320 i	115 - 125	09/06→10/13						
320 d	135 - 147	03/10→10/13		für Fahrzeuge ohne Aktivlenkung		24.9145-0003.2 399007		
BMW - 3 Compact (E36) 01/94→08/00								
 Bremskraftverstärker								
316 g	75	02/96→08/00				03.7760-3102.4 300139	ATE Ø 10" pneumatisch	
316 i	77	01/99→08/00						
318 tds	66	06/95→08/00						
323 ti	120 - 125	09/97→08/00						
316 i	75	01/94→08/00		09/96→; + ABS		03.7760-3102.4 300139	ATE Ø 10" pneumatisch	
				→ 08/96; + ABS		10.6360-1903.4 300093	ATE Ø 10" pneumatisch	
318 ti	103	01/96→08/99		09/96→; + ASC		03.7760-3102.4 300139	ATE Ø 10" pneumatisch	
				- ASC		03.7760-3102.4 300139	ATE Ø 10" pneumatisch	
				→ 08/96; + ASC		10.6360-1903.4 300093	ATE Ø 10" pneumatisch	
Pedalwegsensoren, Bremspedal								
316 i	75	01/94→08/00		→ 08/96; + ABS		03.0655-0002.2 370002	ATE	
318 ti	103	01/96→08/99		→ 08/96; + ASC		03.0655-0002.2 370002	ATE	
 Hauptbremszylinder								
316 i	75	01/94→08/00		→ 08/94; + ABS		10.6123-0239.3 010335	ATE Ø 23,8	
				- ABS		24.2023-1601.3 010341	TRW Ø 23,8	
BMW - 3 Compact (E46) 03/01→02/05								
 Bremskraftverstärker								
316 ti	77 - 85	06/01→02/05				03.7860-0702.4 300123	ATE Ø 10" pneumatisch	
318 td	85	03/03→02/05						
320 td	100 - 110	09/01→02/05						
325 ti	141	04/01→12/04						
318 ti	100 - 105	03/01→12/04		09/01→		03.7860-0702.4 300123	ATE Ø 10" pneumatisch	
 Hauptbremszylinder								
316 ti	77 - 85	06/02→02/05		+ DSC		03.2023-2256.3 010870	ATE Ø1 23,8 Ø2 22,2	
320 td	100 - 110	09/01→02/05		- DSC		03.2023-2344.3 010647	ATE Ø1 23,8 Ø2 22,2	
316 ti	85	06/01→02/05		→ 08/01; - DSC		03.2022-2624.3 010588	Ø1 22,2 Ø2 20,6	
325 ti	141	04/01→12/04		09/01→; + DSC		03.2023-2256.3 010870	ATE Ø1 23,8 Ø2 22,2	
				09/01→; - DSC		03.2023-2344.3 010647	ATE Ø1 23,8 Ø2 22,2	
318 td	85	03/03→02/05		+ DSC		03.2023-2256.3 010870	ATE Ø1 23,8 Ø2 22,2	
318 ti	100 - 105	03/01→12/04		09/01→; + DSC		03.2023-2256.3 010870	ATE Ø1 23,8 Ø2 22,2	
				09/01→; - DSC		03.2023-2344.3 010647	ATE Ø1 23,8 Ø2 22,2	
BMW - 3 Coupe (E36) 10/91→05/99								
 Bremskraftverstärker								
318 is	103	09/95→04/99		09/96→; + ASC		03.7760-3102.4 300139	ATE Ø 10" pneumatisch	
→								















	kw					! #		
BMW - 3 Coupe (E36) 10/91→05/99								
 Bremskraftverstärker								
318 is	103	09/95→04/99		→ 08/96; + ASC		10.6360-1903.4	300093	ATE Ø 10" pneumatisch
323 i	125	05/95→04/99		09/96→; + ASC		03.7760-3102.4	300139	ATE Ø 10" pneumatisch
328 i	142	01/95→04/99		- ASC		03.7760-3102.4	300139	ATE Ø 10" pneumatisch
				→ 08/96; + ASC		10.6360-1903.4	300093	ATE Ø 10" pneumatisch
 Hauptbremszylinder								
318 is	103	09/95→04/99		→ 08/96; + ASC		10.6123-0239.3	010335	ATE Ø 23,8
323 i	125	05/95→04/99						
328 i	142	01/95→04/99						
BMW - 3 Coupe (E46) 12/98→07/06								
 Bremskraftverstärker								
316 Ci	77 - 85	04/00→07/06				03.7860-0702.4	300123	ATE Ø 10" pneumatisch
318 Ci	85 - 110	12/99→05/06						
320 Cd	110	11/03→07/06						
323 Ci	120 - 125	04/99→09/00						
325 Ci	141	09/00→05/06						
328 Ci	142	12/98→05/00						
330 Cd	150	03/03→07/06						
330 Ci	170	06/00→05/06						
330 xi	170	06/00→07/06						
318 Ci	100	12/00→05/06		09/01→		03.7860-0702.4	300123	ATE Ø 10" pneumatisch
320 Ci	110	02/99→08/01		08/99→ 09/00		03.7860-0702.4	300123	ATE Ø 10" pneumatisch
320 Ci	120 - 125	01/00→05/06		09/00→		03.7860-0702.4	300123	ATE Ø 10" pneumatisch
 Hauptbremszylinder								
316 Ci	77	04/00→07/06		→ 08/01; - DSC		03.2022-2624.3	010588	Ø1 22,2 Ø2 20,6
				02/01→; + DSC		03.2023-2256.3	010870	ATE Ø1 23,8 Ø2 22,2
				09/01→; - DSC		03.2023-2344.3	010647	ATE Ø1 23,8 Ø2 22,2
316 Ci	85	06/02→07/06		+ DSC		03.2023-2256.3	010870	ATE Ø1 23,8 Ø2 22,2
318 Ci	105	09/01→02/04		- DSC		03.2023-2344.3	010647	ATE Ø1 23,8 Ø2 22,2
318 Ci	85 - 87	12/99→08/01		- DSC		03.2022-2624.3	010588	Ø1 22,2 Ø2 20,6
				02/01→; + DSC		03.2023-2256.3	010870	ATE Ø1 23,8 Ø2 22,2
318 Ci	100	12/00→05/06		09/01→; + DSC		03.2023-2256.3	010870	ATE Ø1 23,8 Ø2 22,2
				09/01→; - DSC		03.2023-2344.3	010647	ATE Ø1 23,8 Ø2 22,2
318 Ci	110	03/04→05/06				03.2023-2256.3	010870	ATE Ø1 23,8 Ø2 22,2
320 Cd	110	11/03→07/06						
330 Cd	150	03/03→07/06						
320 Ci	110	02/99→08/01		08/99→ 09/00; - DSC		03.2022-2624.3	010588	Ø1 22,2 Ø2 20,6
320 Ci	120 - 125	01/00→05/06		09/00→ 08/01; - DSC		03.2022-2624.3	010588	Ø1 22,2 Ø2 20,6
				09/00→; + DSC		03.2023-2256.3	010870	ATE Ø1 23,8 Ø2 22,2
				09/01→; - DSC		03.2023-2344.3	010647	ATE Ø1 23,8 Ø2 22,2
323 Ci	120 - 125	04/99→09/00		- DSC		03.2022-2624.3	010588	Ø1 22,2 Ø2 20,6
328 Ci	142	12/98→05/00						
325 Ci	141	09/00→05/06		→ 08/01; - DSC		03.2022-2624.3	010588	Ø1 22,2 Ø2 20,6
				+ DSC		03.2023-2256.3	010870	ATE Ø1 23,8 Ø2 22,2
				09/01→; - DSC		03.2023-2344.3	010647	ATE Ø1 23,8 Ø2 22,2
330 Ci	170	06/00→05/06		→ 08/00; + DSC		03.2023-2204.3	010644	ATE Ø1 23,8 Ø2 22,2
330 xi	170	06/00→07/06		09/00→; + DSC		03.2023-2256.3	010870	ATE Ø1 23,8 Ø2 22,2
				→ 08/01; - DSC		03.2023-2304.3	010646	ATE Ø1 23,8 Ø2 22,2
				09/01→; - DSC		03.2023-2344.3	010647	ATE Ø1 23,8 Ø2 22,2
BMW - 3 Coupe (E92) 01/05→12/13								
 Bremskraftverstärker								
316 i	90	09/07→06/13		09/09→; für Fahrzeuge ohne Start-Stopp-Funktion		03.7848-4003.4	300235	ATE Ø 8" pneumatisch
320 i	125	03/07→06/13		→ 08/09		03.7848-4003.4	300235	ATE Ø 8" pneumatisch
318 i	105	03/10→12/13		→ 06/13; für Fahrzeuge ohne Start-Stopp-Funktion		03.7848-4003.4	300235	ATE Ø 8" pneumatisch
320 d	120	03/07→06/13		09/09→; für Fahrzeuge ohne Start-Stopp-Funktion		03.7845-0103.4	300268	ATE Ø 8" pneumatisch
				→ 08/09		03.7848-5003.4	300236	ATE Ø 8" pneumatisch
→								









	kW			 	! #		
BMW - 3 Coupe (E92) 01/05→12/13							
 Bremskraftverstärker							
320 d	130 - 145	09/06→02/10		09/09→; für Fahrzeuge ohne Start-Stopp-Funktion		03.7845-0103.4 300268	ATE Ø 8" pneumatisch
				03/07→ 08/09		03.7848-5003.4 300236	ATE Ø 8" pneumatisch
320 d 320 d xDrive	135 - 147 120 - 147	03/10→06/13 09/08→06/13		für Fahrzeuge ohne Start-Stopp-Funktion		03.7845-0103.4 300268	ATE Ø 8" pneumatisch
320 i	115	06/07→12/13		09/09→ 06/13; für Fahrzeuge ohne Start-Stopp-Funktion		03.7848-4003.4 300235	ATE Ø 8" pneumatisch
				→ 08/09		03.7848-4003.4 300235	ATE Ø 8" pneumatisch
320 i	120	01/07→06/13		09/09→; für Fahrzeuge ohne Start-Stopp-Funktion		03.7848-4003.4 300235	ATE Ø 8" pneumatisch
				03/07→ 08/09		03.7848-4003.4 300235	ATE Ø 8" pneumatisch
323 i	140	04/06→02/12		09/07→		03.7845-0103.4 300268	ATE Ø 8" pneumatisch
				09/06→ 08/07		03.7848-5003.4 300236	ATE Ø 8" pneumatisch
325 d	145 - 155	02/07→02/10		03/07→		03.7848-5003.4 300236	ATE Ø 8" pneumatisch
325 d 325 i 325 i xDrive 325 xi 328 i 328 i xDrive 328 xi 330 d xDrive 330 i 330 i xDrive	150 150 - 160 150 - 155 155 - 160 172 172 172 180 190 200	09/09→06/13 09/07→10/13 09/08→06/13 09/06→02/10 06/06→06/13 09/08→06/13 09/06→08/08 02/10→06/13 03/10→06/13 03/10→06/13				03.7848-5003.4 300236	ATE Ø 8" pneumatisch
325 i	160	06/06→02/10		09/06→		03.7848-5003.4 300236	ATE Ø 8" pneumatisch
325 i xDrive	160	09/08→12/13		→ 06/13		03.7848-5003.4 300236	ATE Ø 8" pneumatisch
330 d 330 xd 335 d 335 i	170 170 210 225 - 240	03/06→08/08 03/06→08/08 03/06→03/13 06/06→06/13		09/06→		03.7845-0103.4 300268	ATE Ø 8" pneumatisch
330 d 330 i 330 xd	180 200 180	01/09→06/13 09/06→06/13 03/08→02/10		→ 08/09 09/09→		03.7845-0103.4 300268 03.7848-5003.4 300236	ATE Ø 8" pneumatisch ATE Ø 8" pneumatisch
330 xi 335 i 335 i xDrive	190 - 200 224 225 - 240	09/06→08/07 03/07→06/13 11/08→12/13				03.7845-0103.4 300268	ATE Ø 8" pneumatisch
330 xi	200	03/07→02/10		→ 08/09		03.7845-0103.4 300268	ATE Ø 8" pneumatisch
						03.7848-5003.4 300236	ATE Ø 8" pneumatisch
335 xi	225 - 240	03/07→02/10		09/07→		03.7845-0103.4 300268	ATE Ø 8" pneumatisch
 Hauptbremszylinder							
316 i	90	09/07→06/13		für Linkslenker		03.2023-2407.3 010796	ATE Ø1 23,8 Ø2 22,2
318 i	105	03/10→12/13		für Linkslenker; → 06/13		03.2023-2407.3 010796	ATE Ø1 23,8 Ø2 22,2
320 d 325 d 325 i 330 d 330 i 335 i	120 - 147 150 150 - 160 180 190 - 200 224	03/07→06/13 09/09→06/13 09/07→10/13 01/09→06/13 09/06→06/13 03/07→06/13		für Linkslenker		03.2025-1904.3 010797	ATE Ø1 25,4 Ø2 22,2
320 d 325 d	130 - 145 145 - 155	09/06→02/10 02/07→02/10		03/07→; für Linkslenker		03.2025-1904.3 010797	ATE Ø1 25,4 Ø2 22,2
320 d xDrive 325 i xDrive 325 xi 328 i 328 i xDrive 328 xi 330 d xDrive 330 i xDrive →	120 - 147 150 - 155 155 - 160 172 172 172 180 200	09/08→06/13 09/08→06/13 09/06→02/10 06/06→06/13 09/08→06/13 09/06→08/08 02/10→06/13 03/10→06/13				03.2025-1904.3 010797	ATE Ø1 25,4 Ø2 22,2













	kW			 	! #		
BMW - 3 Coupe (E92) 01/05→12/13							
 Hauptbremszylinder							
330 xd 330 xi	180 190 - 200	03/08→02/10 09/06→02/10				03.2025-1904.3 010797	ATE Ø1 25,4 Ø2 22,2
335 i xDrive	225 - 240	11/08→12/13					
320 i	115	06/07→12/13		09/07→ 06/13; für Linkslenker → 08/07; für Linkslenker		03.2023-2407.3 010796 03.2025-1904.3 010797	ATE Ø1 23,8 Ø2 22,2 ATE Ø1 25,4 Ø2 22,2
320 i	120	01/07→06/13		09/07→; für Linkslenker 03/07→ 08/07; für Linkslenker		03.2023-2407.3 010796 03.2025-1904.3 010797	ATE Ø1 23,8 Ø2 22,2 ATE Ø1 25,4 Ø2 22,2
320 i	125	03/07→06/13		09/07→; für Linkslenker → 08/07; für Linkslenker		03.2023-2407.3 010796 03.2025-1904.3 010797	ATE Ø1 23,8 Ø2 22,2 ATE Ø1 25,4 Ø2 22,2
325 i 330 d 335 d 335 i	160 170 210 225 - 240	06/06→02/10 03/06→08/08 03/06→03/13 06/06→06/13		09/06→; für Linkslenker		03.2025-1904.3 010797	ATE Ø1 25,4 Ø2 22,2
325 i xDrive	160	09/08→12/13		→ 06/13		03.2025-1904.3 010797	ATE Ø1 25,4 Ø2 22,2
330 xd	170	03/06→08/08		09/06→		03.2025-1904.3 010797	ATE Ø1 25,4 Ø2 22,2
335 xi	225 - 240	03/07→02/10		09/07→		03.2025-1904.3 010797	ATE Ø1 25,4 Ø2 22,2
Hydraulikaggregat, Bremsanlage							
316 i	90	09/07→06/13		09/08→		24.9145-0003.2 399007	
318 i	105	03/10→12/13		→ 06/13		24.9145-0003.2 399007	
320 d 320 i	120 - 145 120 - 125	09/06→06/13 01/07→06/13		09/08→; für Fahrzeuge ohne Aktivlenkung		24.9145-0003.2 399007	
320 d	135 - 147	03/10→06/13		für Fahrzeuge ohne Aktivlenkung		24.9145-0003.2 399007	
320 i	115	06/07→12/13		09/08→ 06/13; für Fahrzeuge ohne Aktivlenkung		24.9145-0003.2 399007	
BMW - 3 Gran Turismo (F34) 07/12→							
 Hauptbremszylinder							
318 d 320 d 320 i 320 i xDrive	100 - 110 120 - 147 120 - 135 120 - 135	03/13→ 03/13→ 03/13→ 07/13→		für Linkslenker; - Performance Parts für Linkslenker; + Performance Parts		24.4123-1736.3 011118 24.4125-1713.3 011109	Ø 23,8 ohne Bremsflüssigkeitsbehälter Ø 25,4 ohne Bremsflüssigkeitsbehälter
320 d xDrive	120 - 147	07/13→		für Linkslenker		24.4125-1713.3 011109	Ø 25,4 ohne Bremsflüssigkeitsbehälter
328 i 328 i xDrive 330 d 330 d xDrive 335 d xDrive 335 i 335 i xDrive	180 180 190 190 230 225 - 250 225 - 250	03/13→06/16 07/13→06/16 03/14→ 03/14→ 03/14→ 03/13→06/16 03/13→06/16					
320 i xDrive	135	11/12→06/16		03/13→; für Linkslenker; - Performance Parts 03/13→; für Linkslenker; + Performance Parts		24.4123-1736.3 011118 24.4125-1713.3 011109	Ø 23,8 ohne Bremsflüssigkeitsbehälter Ø 25,4 ohne Bremsflüssigkeitsbehälter
325 d 330 i 330 i xDrive 340 i 340 i xDrive	155 - 165 185 183 - 185 240 - 265 240 - 265	07/13→02/18 07/16→ 07/16→ 07/16→ 07/16→		für Linkslenker; - Performance Parts		24.4125-1713.3 011109	Ø 25,4 ohne Bremsflüssigkeitsbehälter
330 d 330 d xDrive	210 210	03/14→ 03/14→		09/15→; für Linkslenker		24.4125-1713.3 011109	Ø 25,4 ohne Bremsflüssigkeitsbehälter
BMW - 3 Touring (E36) 08/94→12/99							
 Bremskraftverstärker							
316 i 318 i 318 tds →	75 85 66	03/97→05/99 09/95→04/99 03/95→04/99				03.7760-3102.4 300139	ATE Ø 10" pneumatisch











	kw					! #		
BMW - 3 Touring (E36) 08/94→12/99								
 Bremskraftverstärker								
325 tds	105	03/95→04/99					03.7760-3102.4 300139	ATE Ø 10" pneumatisch
320 i	110	01/95→04/99		09/96→; + ASC			03.7760-3102.4 300139	ATE Ø 10" pneumatisch
323 i	125	12/95→04/99		- ASC			03.7760-3102.4 300139	ATE Ø 10" pneumatisch
328 i	142	02/95→04/99		→ 08/96; + ASC			10.6360-1903.4 300093	ATE Ø 10" pneumatisch
Pedalwegsensoren, Bremspedal								
320 i	110	01/95→04/99		→ 08/96			03.0655-0002.2 370002	ATE
323 i	125	12/95→04/99						
328 i	142	02/95→04/99						
 Hauptbremszylinder								
320 i	110	01/95→04/99		→ 08/96; + ASC			10.6123-0239.3 010335	ATE Ø 23,8
323 i	125	12/95→04/99						
328 i	142	02/95→04/99						
BMW - 3 Touring (E46) 06/99→07/05								
 Bremskraftverstärker								
316 i	85	03/02→02/05					03.7860-0702.4 300123	ATE Ø 10" pneumatisch
318 d	85	10/02→02/05						
318 i	85 - 105	10/99→07/05						
320 d	100 - 110	03/00→02/05						
320 i	110 - 125	10/99→02/05						
325 i	141	09/00→02/05						
325 xi	141	09/00→02/05						
328 i	142	06/99→05/00						
330 d	135 - 150	10/99→02/05						
330 i	170	06/00→02/05						
330 xi	170	06/00→02/05						
330 xd	135	01/00→03/03		06/00→			03.7860-0702.4 300123	ATE Ø 10" pneumatisch
330 xd	150	08/02→05/05		03/03→ 02/05			03.7860-0702.4 300123	ATE Ø 10" pneumatisch
 Hauptbremszylinder								
316 i	85	03/02→02/05		+ DSC			03.2023-2256.3 010870	ATE Ø1 23,8 Ø2 22,2
318 d	85	10/02→02/05						
318 i	105	09/01→07/05		- DSC			03.2023-2344.3 010647	ATE Ø1 23,8 Ø2 22,2
320 d	110	09/01→02/05						
318 i	85 - 87	10/99→09/01		- DSC			03.2022-2624.3 010588	Ø1 22,2 Ø2 20,6
320 d	100	03/00→09/01						
320 i	110	10/99→09/00						
328 i	142	06/99→05/00						
320 i	120 - 125	09/00→02/05		→ 08/01; - DSC			03.2022-2624.3 010588	Ø1 22,2 Ø2 20,6
				+ DSC			03.2023-2256.3 010870	ATE Ø1 23,8 Ø2 22,2
				09/01→; - DSC			03.2023-2344.3 010647	ATE Ø1 23,8 Ø2 22,2
325 i	141	09/00→02/05		→ 08/01; - DSC			03.2022-2624.3 010588	Ø1 22,2 Ø2 20,6
				02/01→; + DSC			03.2023-2256.3 010870	ATE Ø1 23,8 Ø2 22,2
				09/01→; - DSC			03.2023-2344.3 010647	ATE Ø1 23,8 Ø2 22,2
330 d	135	10/99→02/05		→ 08/00; + DSC			03.2023-2204.3 010644	ATE Ø1 23,8 Ø2 22,2
				09/00→; + DSC			03.2023-2256.3 010870	ATE Ø1 23,8 Ø2 22,2
				→ 08/01; - DSC			03.2023-2304.3 010646	ATE Ø1 23,8 Ø2 22,2
				09/01→; - DSC			03.2023-2344.3 010647	ATE Ø1 23,8 Ø2 22,2
330 d	150	03/03→02/05		+ DSC			03.2023-2256.3 010870	ATE Ø1 23,8 Ø2 22,2
330 i	170	06/00→02/05		→ 08/01; + DSC			03.2023-2204.3 010644	ATE Ø1 23,8 Ø2 22,2
				09/01→; + DSC			03.2023-2256.3 010870	ATE Ø1 23,8 Ø2 22,2
				→ 08/01; - DSC			03.2023-2304.3 010646	ATE Ø1 23,8 Ø2 22,2
				09/01→; - DSC			03.2023-2344.3 010647	ATE Ø1 23,8 Ø2 22,2
BMW - 3 Touring (E91) 12/04→12/12								
 Bremskraftverstärker								
316 d	85	09/09→06/12		→ 05/12; für Fahrzeuge ohne Start-Stopp-Funktion			03.7848-4003.4 300235	ATE Ø 8" pneumatisch
316 i	90	09/08→06/12		für Fahrzeuge ohne Start-Stopp-Funktion			03.7848-4003.4 300235	ATE Ø 8" pneumatisch
318 d	90	09/05→08/07					03.7848-5003.4 300236	ATE Ø 8" pneumatisch
320 d	110 - 120	12/04→06/12						
325 xi	155 - 160	08/05→08/08						
→								





















	kw			 	! #		
BMW - 3 Touring (E91) 12/04→12/12							
 Bremskraftverstärker							
330 d	155	06/05→05/12				03.7848-5003.4 300236	ATE Ø 8" pneumatisch
330 i	190	08/05→08/07					
330 xi	190	09/05→08/07					
318 d	100	07/07→06/12		09/07→ 05/12		03.7845-0103.4 300268	ATE Ø 8" pneumatisch
318 d	105	09/07→06/12		→ 05/12		03.7845-0103.4 300268	ATE Ø 8" pneumatisch
320 d xDrive	120	07/09→06/12					
330 i	200	03/07→06/12					
335 d	210	09/06→06/12					
318 i	95	01/06→08/07		03/07→; Motorcode: N46N		03.7845-0103.4 300268	ATE Ø 8" pneumatisch
				Motorcode: N46		03.7848-5003.4 300236	ATE Ø 8" pneumatisch
318 i	100	09/07→03/12				03.7845-0103.4 300268	ATE Ø 8" pneumatisch
320 d	135 - 147	03/10→05/12					
320 d xDrive	130 - 147	02/08→06/12					
323 i	140	09/06→07/08					
330 d xDrive	180	01/09→06/12					
335 i	225 - 240	09/06→06/12					
335 i xDrive	225 - 240	09/08→06/12					
335 xi	225 - 240	03/07→08/08					
318 i	105	05/07→05/12		09/07→		03.7845-0103.4 300268	ATE Ø 8" pneumatisch
320 d	130 - 145	02/07→12/10					
320 i	120 - 125	02/07→12/12					
320 i	110 - 115	09/05→06/12		→ 08/07; Motorcode: N46N		03.7845-0103.4 300268	ATE Ø 8" pneumatisch
				→ 08/07; Motorcode: N46		03.7848-5003.4 300236	ATE Ø 8" pneumatisch
323 i	130	04/06→06/07		09/06→		03.7845-0103.4 300268	ATE Ø 8" pneumatisch
325 d	145 - 150	09/06→06/12		→ 05/12		03.7848-5003.4 300236	ATE Ø 8" pneumatisch
325 i	160	09/07→06/12					
325 i xDrive	155 - 160	09/08→06/12					
330 i xDrive	200	09/07→06/12					
330 xd	170	09/05→06/12					
330 xi	200	09/07→06/12					
325 i	155 - 160	12/04→12/10		06/05→		03.7848-5003.4 300236	ATE Ø 8" pneumatisch
330 d	170	12/04→08/08					
325 i	155	09/07→06/12		01/12→ 05/12		03.7848-5003.4 300236	ATE Ø 8" pneumatisch
330 d	180	02/08→05/12		09/08→		03.7845-0103.4 300268	ATE Ø 8" pneumatisch
 Hauptbremszylinder							
316 d	85	09/09→06/12		für Linkslenker; → 05/12		03.2023-2407.3 010796	ATE Ø1 23,8 Ø2 22,2
316 i	90	09/08→06/12				03.2023-2407.3 010796	ATE Ø1 23,8 Ø2 22,2
318 d	90	09/05→08/07		für Linkslenker		03.2025-1904.3 010797	ATE Ø1 25,4 Ø2 22,2
318 i	95	01/06→08/07					
320 d	110 - 147	12/04→06/12					
330 d xDrive	180	01/09→06/12					
330 i	190	08/05→08/07					
335 i	225 - 240	09/06→06/12					
318 d	100	07/07→06/12		09/07→ 05/12		03.2025-1904.3 010797	ATE Ø1 25,4 Ø2 22,2
318 d	105	09/07→06/12		→ 05/12		03.2025-1904.3 010797	ATE Ø1 25,4 Ø2 22,2
320 d xDrive	120	07/09→06/12					
325 d	145 - 150	09/06→06/12					
325 i xDrive	155 - 160	09/08→06/12					
330 i xDrive	200	09/07→06/12					
330 xd	170	09/05→06/12					
330 xi	200	09/07→06/12					
318 i	100	09/07→03/12				03.2025-1904.3 010797	ATE Ø1 25,4 Ø2 22,2
320 d xDrive	130 - 147	02/08→06/12					
325 xi	155 - 160	08/05→08/08					
330 d	155	06/05→05/12					
330 xi	190	09/05→08/07					
335 i xDrive	225 - 240	09/08→06/12					
335 xi	225 - 240	03/07→08/08					
→							











	kW			 	! #		
BMW - 3 Touring (E91) 12/04→12/12							
 Hauptbremszylinder							
318 i	105	05/07→05/12		09/07→		03.2025-1904.3 010797	ATE Ø1 25,4 Ø2 22,2
320 d	130 - 145	02/07→12/10		09/07→; für Linkslenker		03.2025-1904.3 010797	ATE Ø1 25,4 Ø2 22,2
320 i	120 - 125	02/07→12/12					
320 i	110 - 115	09/05→06/12		→ 08/07; für Linkslenker		03.2025-1904.3 010797	ATE Ø1 25,4 Ø2 22,2
325 i	155 - 160	12/04→12/10		06/05→; für Linkslenker		03.2025-1904.3 010797	ATE Ø1 25,4 Ø2 22,2
325 i	155	09/07→06/12		01/12→; für Linkslenker; → 05/12		03.2025-1904.3 010797	ATE Ø1 25,4 Ø2 22,2
325 i	160	09/07→06/12		→ 05/12; für Linkslenker		03.2025-1904.3 010797	ATE Ø1 25,4 Ø2 22,2
330 i	200	03/07→06/12					
335 d	210	09/06→06/12					
330 d	170	12/04→08/08		06/05→		03.2025-1904.3 010797	ATE Ø1 25,4 Ø2 22,2
330 d	180	02/08→05/12		09/08→; für Linkslenker		03.2025-1904.3 010797	ATE Ø1 25,4 Ø2 22,2
Hydraulikaggregat, Bremsanlage							
316 d	85	09/09→06/12		→ 05/12		24.9145-0003.2 399007	
316 i	90	09/08→06/12				24.9145-0003.2 399007	
318 d	100 - 105	07/07→06/12		09/08→ 05/12		24.9145-0003.2 399007	
318 i	100 - 105	05/07→05/12		09/08→		24.9145-0003.2 399007	
320 d	130 - 145	02/07→12/10		09/08→; für Fahrzeuge ohne Aktivlenkung		24.9145-0003.2 399007	
320 i	120 - 125	02/07→12/12					
320 d	135 - 147	03/10→05/12		für Fahrzeuge ohne Aktivlenkung		24.9145-0003.2 399007	
BMW - 3 Touring (F31) 07/12→06/19							
 Hauptbremszylinder							
316 d	85	11/12→06/19		für Linkslenker; für Fahrzeuge ohne Start-Stopp-Funktion		24.4123-1736.3 011118	Ø 23,8 ohne Bremsflüssigkeitsbehälter
318 d	100 - 105	11/12→06/19					
320 d	120	07/12→06/19		für Linkslenker; für Fahrzeuge mit Start-Stopp-Funktion		24.4125-1713.3 011109	Ø 25,4 ohne Bremsflüssigkeitsbehälter
320 i	120 - 135	11/12→06/19					
320 i xDrive	120 - 135	03/13→06/19					
316 i	100	03/13→06/15		für Linkslenker		24.4123-1736.3 011118	Ø 23,8 ohne Bremsflüssigkeitsbehälter
318 d	110	07/15→06/19		- Performance Parts; für Linkslenker		24.4123-1736.3 011118	Ø 23,8 ohne Bremsflüssigkeitsbehälter
318 d xDrive	105 - 110	07/13→02/18					
318 i	100	07/15→06/19		für Linkslenker; + Performance Parts		24.4125-1713.3 011109	Ø 25,4 ohne Bremsflüssigkeitsbehälter
320 d	135 - 147	07/12→06/19		für Linkslenker		24.4125-1713.3 011109	Ø 25,4 ohne Bremsflüssigkeitsbehälter
320 d xDrive	120 - 147	03/13→06/19					
325 d	165	03/16→02/18					
328 i	180	07/12→06/15					
328 i xDrive	180	03/13→06/16					
330 d	190	07/12→06/19					
330 d xDrive	190	03/13→06/19					
335 d xDrive	230	11/13→06/19					
335 i	225 - 250	03/13→06/15					
335 i xDrive	225 - 250	03/13→06/15					
325 d	155 - 160	03/13→02/16		04/13→; für Linkslenker		24.4125-1713.3 011109	Ø 25,4 ohne Bremsflüssigkeitsbehälter
330 d	210	07/12→06/19		09/15→; für Linkslenker; - Performance Parts		24.4125-1713.3 011109	Ø 25,4 ohne Bremsflüssigkeitsbehälter
330 d xDrive	210	03/13→06/19					
330 i	185	07/15→06/19		für Linkslenker; - Performance Parts		24.4125-1713.3 011109	Ø 25,4 ohne Bremsflüssigkeitsbehälter
330 i xDrive	185	07/15→06/19					
340 i	240 - 265	07/15→06/19					
BMW - 3 Touring Van (F31) 07/12→06/19							
 Hauptbremszylinder							
330 d	190	07/12→06/19		für Linkslenker		24.4125-1713.3 011109	Ø 25,4 ohne Bremsflüssigkeitsbehälter
330 d xDrive	190	03/13→06/19					
330 i	185	07/15→06/19		- Performance Parts; für Linkslenker		24.4125-1713.3 011109	Ø 25,4 ohne Bremsflüssigkeitsbehälter
340 i	240	07/15→06/19					















	kw			 	! #		
BMW - 4 Cabriolet (F33, F83) 10/13→08/20							
 Hauptbremszylinder							
420 d	120 - 147	10/13→07/20		für Linkslenker		24.4125-1713.3 011109	Ø 25,4 ohne Bremsflüssigkeitsbehälter
425 d	155 - 160	07/14→02/16					
428 i	180	11/13→02/17					
428 i xDrive	180	03/14→02/16					
430 d	190 - 210	07/14→07/20					
435 d xDrive	230	07/14→07/20					
435 i	225 - 250	11/13→02/16					
435 i xDrive	225 - 250	07/14→02/16					
420 d	140 - 151	07/15→07/20		für Linkslenker; - Performance Parts		24.4125-1713.3 011109	Ø 25,4 ohne Bremsflüssigkeitsbehälter
425 d	165	03/16→02/18					
430 i	185	03/16→07/20					
430 i xDrive	185	03/16→07/20					
440 i	240 - 265	03/16→07/20					
440 i xDrive	240 - 265	03/16→07/20					
420 i	120 - 135	07/14→07/20		für Linkslenker; - Performance Parts		24.4123-1736.3 011118	Ø 23,8 ohne Bremsflüssigkeitsbehälter
425 i	135	06/17→07/20		für Linkslenker; + Performance Parts		24.4125-1713.3 011109	Ø 25,4 ohne Bremsflüssigkeitsbehälter
BMW - 4 Coupe (F32, F82) 07/13→06/20							
 Hauptbremszylinder							
418 d	100 - 110	03/15→10/17		für Linkslenker; - Performance Parts		24.4123-1736.3 011118	Ø 23,8 ohne Bremsflüssigkeitsbehälter
418 i	100	03/16→06/20					
420 d	120 - 147	07/13→06/20		für Linkslenker; + Performance Parts		24.4125-1713.3 011109	Ø 25,4 ohne Bremsflüssigkeitsbehälter
420 d xDrive	120 - 147	11/13→06/20					
420 i	120 - 135	11/13→02/17					
420 i xDrive	120 - 135	11/13→02/16					
428 i	180	07/13→02/17					
428 i xDrive	180	07/13→02/16					
435 i	225 - 250	07/13→02/16					
435 i xDrive	225 - 250	07/13→02/16					
420 i	120 - 135	03/16→06/20		für Linkslenker; Motorcode: B48; - Performance Parts		24.4123-1736.3 011118	Ø 23,8 ohne Bremsflüssigkeitsbehälter
420 i xDrive	120 - 135	03/16→06/20		für Linkslenker; Motorcode: B48; + Performance Parts		24.4125-1713.3 011109	Ø 25,4 ohne Bremsflüssigkeitsbehälter
425 i	135	06/17→06/20					
425 d	155 - 160	03/14→02/16		für Linkslenker		24.4125-1713.3 011109	Ø 25,4 ohne Bremsflüssigkeitsbehälter
430 d	190 - 210	11/13→06/20					
430 d xDrive	190 - 210	03/14→06/20					
435 d xDrive	230	11/13→06/20					
425 d	165	03/16→10/17		- Performance Parts; für Linkslenker		24.4125-1713.3 011109	Ø 25,4 ohne Bremsflüssigkeitsbehälter
430 i	183 - 185	03/16→06/20					
430 i xDrive	183 - 185	03/16→06/20					
440 i	240 - 265	03/16→06/20					
440 i xDrive	240 - 265	03/16→06/20					
BMW - 4 Gran Coupe (F36) 03/14→05/21							
 Hauptbremszylinder							
418 d	100 - 105	03/14→12/20		- Performance Parts		24.4123-1736.3 011118	Ø 23,8 ohne Bremsflüssigkeitsbehälter
418 i	100	07/15→12/20					
420 d	120 - 147	03/14→12/20		+ Performance Parts		24.4125-1713.3 011109	Ø 25,4 ohne Bremsflüssigkeitsbehälter
418 d	110	07/15→12/20		- Performance Parts; für Linkslenker		24.4123-1736.3 011118	Ø 23,8 ohne Bremsflüssigkeitsbehälter
420 i	120 - 135	03/16→05/21					
420 i xDrive	120 - 135	03/16→05/21		für Linkslenker; + Performance Parts		24.4125-1713.3 011109	Ø 25,4 ohne Bremsflüssigkeitsbehälter
→							













	kw			 	! #		
BMW - 4 Gran Coupe (F36) 03/14→05/21							
 Hauptbremszylinder							
425 i	135	06/17→12/20		- Performance Parts; für Linkslenker		24.4123-1736.3 011118	Ø 23,8 ohne Bremsflüssigkeitsbehälter
				für Linkslenker; + Performance Parts		24.4125-1713.3 011109	Ø 25,4 ohne Bremsflüssigkeitsbehälter
420 d 420 d xDrive	140 120 - 147	03/15→12/20 03/14→12/20		für Linkslenker		24.4125-1713.3 011109	Ø 25,4 ohne Bremsflüssigkeitsbehälter
420 i 420 i xDrive	120 - 135 120 - 135	03/14→02/17 07/14→02/16					
428 i 430 d	180 190 - 210	03/14→06/16 07/14→12/20					
430 d xDrive 435 d xDrive 435 i	190 - 210 230 225 - 250	07/14→12/20 03/14→02/16					
425 d 430 i 430 i xDrive	155 - 165 185 183 - 185	03/16→02/18 03/16→05/21 03/16→05/21		für Linkslenker; - Performance Parts		24.4125-1713.3 011109	Ø 25,4 ohne Bremsflüssigkeitsbehälter
440 i 440 i xDrive	240 - 265 240 - 265	03/16→05/21 03/16→05/21					
428 i xDrive 435 i xDrive	180 225 - 250	03/14→02/16 07/14→02/16				24.4125-1713.3 011109	Ø 25,4 ohne Bremsflüssigkeitsbehälter
BMW - 5 (E39) 09/95→07/03							
 Hauptbremszylinder							
520 d	100	02/00→06/03		04/00→		24.2025-1705.3 010624	TRW Ø1 25,4 Ø2 20,6
520 i	100 - 125	01/96→06/03		+ DSC		24.2025-1704.3 010619	Ø 25,4
530 d	142	09/98→06/03		- DSC		24.2025-1705.3 010624	TRW Ø1 25,4 Ø2 20,6
520 i	110	01/96→06/03		03/96→; + DSC		24.2025-1704.3 010619	Ø 25,4
				09/97→; - DSC		24.2025-1705.3 010624	TRW Ø1 25,4 Ø2 20,6
				03/96→ 08/97; - DSC		24.2120-1721.3 010553	Ø 20,6
523 i 528 i	125 142	09/95→08/00 09/95→08/00		12/95→; + DSC		24.2025-1704.3 010619	Ø 25,4
				09/97→; - DSC		24.2025-1705.3 010624	TRW Ø1 25,4 Ø2 20,6
				12/95→ 08/97; - DSC		24.2120-1721.3 010553	Ø 20,6
525 d	120	02/00→06/03		04/00→; + DSC		24.2025-1704.3 010619	Ø 25,4
				04/00→; - DSC		24.2025-1705.3 010624	TRW Ø1 25,4 Ø2 20,6
525 i 530 i	141 170	09/00→06/03 09/00→06/03		10/00→; + DSC		24.2025-1704.3 010619	Ø 25,4
				10/00→; - DSC		24.2025-1705.3 010624	TRW Ø1 25,4 Ø2 20,6
525 td	85	01/97→06/03		09/97→ 09/00		24.2025-1705.3 010624	TRW Ø1 25,4 Ø2 20,6
				→ 08/97		24.2120-1721.3 010553	Ø 20,6
525 tds	105	01/96→06/03		09/97→ 09/00		24.2025-1705.3 010624	TRW Ø1 25,4 Ø2 20,6
				02/96→ 08/97		24.2120-1721.3 010553	Ø 20,6
530 d	135	08/98→09/00		09/98→; + DSC		24.2025-1704.3 010619	Ø 25,4
				09/98→; - DSC		24.2025-1705.3 010624	TRW Ø1 25,4 Ø2 20,6
535 i M5	180 294	09/98→06/03 10/98→06/03				24.2025-1704.3 010619	Ø 25,4
540 i	210	03/96→06/03		09/97→		24.2025-1704.3 010619	Ø 25,4
				05/96→ 08/97		24.2120-1721.3 010553	Ø 20,6
BMW - 5 (E60) 12/01→03/10							
 Hauptbremszylinder							
520 d	110 - 130	09/05→12/09				24.2026-1702.3 010850	TRW Ø 27 Ø2 22,2
523 i 525 d xDrive 525 xd 525 xi 528 i 530 d 530 d xDrive 530 i 530 i xDrive →	140 145 145 160 172 170 173 200 200	03/07→12/09 09/08→12/09 09/07→08/08 04/05→12/09 03/07→12/09 09/05→03/07 09/07→12/09 03/07→12/09 09/08→12/09					

	kW			 	! #		
BMW - 5 (E60) 12/01→03/10							
 Hauptbremszylinder							
530 xd	173	03/07→08/07				24.2026-1702.3 010850	TRW Ø 27 Ø2 22,2
530 xi	200	03/07→10/09					
535 i	225	04/06→12/09					
540 i	220 - 225	09/05→12/09					
545 i	245	07/03→08/05					
550 i	270	09/05→12/09					
M5	373	09/04→12/09					
520 i	125	07/03→03/10		→ 03/05		24.2025-1710.3 010833	TRW Ø 25,4
523 i	130	10/04→02/07		07/05→		24.2026-1702.3 010850	TRW Ø 27 Ø2 22,2
525 i	137 - 160	07/03→12/09					
530 i	190	03/05→03/07					
530 xd	170	02/05→02/07					
530 xi	190	09/04→02/07					
525 d	120 - 130	06/04→03/10		→ 03/07		24.2026-1702.3 010850	TRW Ø 27 Ø2 22,2
535 d	200	09/04→03/10					
525 d	145	01/07→03/10		03/07→ 02/10		24.2026-1702.3 010850	TRW Ø 27 Ø2 22,2
535 d	210	01/07→03/10					
525 i	141	09/03→02/05				24.2025-1710.3 010833	TRW Ø 25,4
525 i	155 - 160	07/05→03/10		→ 02/10		24.2026-1702.3 010850	TRW Ø 27 Ø2 22,2
525 i xDrive	160	09/08→03/10					
530 d	155 - 160	09/02→12/09		07/03→ 08/05		24.2026-1702.3 010850	TRW Ø 27 Ø2 22,2
530 d	173	02/07→12/09		03/07→		24.2026-1702.3 010850	TRW Ø 27 Ø2 22,2
530 xi	200	02/07→08/08					
530 i	170	12/01→02/05		07/03→		24.2025-1710.3 010833	TRW Ø 25,4
530 i	187	03/05→03/10		07/05→ 03/07		24.2026-1702.3 010850	TRW Ø 27 Ø2 22,2
BMW - 5 (F10) 01/09→10/16							
 Hauptbremszylinder							
518 d	100 - 110	07/13→10/16				24.2026-1706.3 011040	TRW Ø 27 Ø2 22,2
520 d	100 - 151	06/10→10/16					
520 d xDrive	100 - 151	01/13→10/16					
520 i	120 - 135	09/11→10/16					
525 d	150 - 160	03/10→10/16					
525 d xDrive	155 - 160	09/11→10/16					
528 i	180 - 190	03/10→10/16					
528 i xDrive	180	09/11→10/16					
530 d	190	09/11→10/16					
530 d xDrive	190	03/11→10/16					
535 d	220 - 230	09/10→10/16					
535 d xDrive	230	09/11→10/16					
535 i	240	07/13→10/16					
535 i xDrive	225 - 240	03/11→10/16					
550 i	300 - 330	03/10→10/16					
550 i xDrive	330	07/13→10/16					
M 550 d xDrive	280	03/12→10/16					
518 d	120	10/13→10/16		07/14→		24.2026-1706.3 011040	TRW Ø 27 Ø2 22,2
520 d	155	10/13→10/16					
520 d xDrive	155	10/13→10/16					
520 d xDrive	147	01/13→06/14		02/13→		24.2026-1706.3 011040	TRW Ø 27 Ø2 22,2
523 i	150 - 155	06/09→08/11		03/10→		24.2026-1706.3 011040	TRW Ø 27 Ø2 22,2
530 d	180	01/10→08/11					
535 i	225	01/10→10/16					
530 d	210	09/10→10/16		10/15→		24.2026-1706.3 011040	TRW Ø 27 Ø2 22,2
530 d xDrive	210	03/11→10/16					
530 i	190 - 200	03/10→06/13		09/11→		24.2026-1706.3 011040	TRW Ø 27 Ø2 22,2
550 i xDrive	300	08/10→06/13		09/10→		24.2026-1706.3 011040	TRW Ø 27 Ø2 22,2











	kw			 	! #		
BMW - 5 Gran Turismo (F07) 01/09→02/17							
 Hauptbremszylinder							
520 d	100 - 120	07/12→02/17				24.2026-1702.3 010850	TRW Ø 27 Ø2 22,2
530 d	155 - 190	09/10→02/17					
530 d xDrive	190	07/12→02/17					
535 d	220 - 230	03/10→02/17					
535 d xDrive	230	07/12→02/17					
535 i xDrive	225	09/10→02/17					
550 i	330	07/12→02/17					
550 i xDrive	330	07/12→02/17					
520 d	135	04/11→02/17		10/11→		24.2026-1702.3 010850	TRW Ø 27 Ø2 22,2
528 i	180	07/13→02/17		08/13→		24.2026-1702.3 010850	TRW Ø 27 Ø2 22,2
530 d	180	08/09→06/12		10/09→		24.2026-1702.3 010850	TRW Ø 27 Ø2 22,2
535 i	225	01/09→02/17					
550 i	300	08/09→06/12					
530 d xDrive	180	06/10→06/12		09/10→		24.2026-1702.3 010850	TRW Ø 27 Ø2 22,2
535 d xDrive	220	03/10→06/12					
550 i xDrive	300	06/10→06/12					
BMW - 5 Touring (E39) 09/96→06/04							
 Hauptbremszylinder							
520 d	100	02/00→09/03		04/00→ 07/03		24.2025-1705.3 010624	TRW Ø1 25,4 Ø2 20,6
520 i	100	03/97→08/01		+ DSC		24.2025-1704.3 010619	Ø 25,4
523 i	120	09/98→08/00		- DSC		24.2025-1705.3 010624	TRW Ø1 25,4 Ø2 20,6
520 i	110	03/97→08/01		05/97→; + DSC		24.2025-1704.3 010619	Ø 25,4
523 i	125	03/97→08/00		09/97→; - DSC		24.2025-1705.3 010624	TRW Ø1 25,4 Ø2 20,6
528 i	142	11/96→08/00		05/97→ 08/97; - DSC		24.2120-1721.3 010553	Ø 20,6
520 i	120 - 125	09/00→12/03		→ 07/03; + DSC		24.2025-1704.3 010619	Ø 25,4
530 d	142	09/00→05/04		→ 07/03; - DSC		24.2025-1705.3 010624	TRW Ø1 25,4 Ø2 20,6
525 d	120	02/00→05/04		04/00→ 07/03; + DSC		24.2025-1704.3 010619	Ø 25,4
				04/00→ 07/03; - DSC		24.2025-1705.3 010624	TRW Ø1 25,4 Ø2 20,6
525 i	141	09/00→05/04		10/00→ 07/03; + DSC		24.2025-1704.3 010619	Ø 25,4
530 i	170	09/00→12/03		10/00→ 07/03; - DSC		24.2025-1705.3 010624	TRW Ø1 25,4 Ø2 20,6
525 tds	105	03/97→05/04		06/98→ 09/00		24.2025-1705.3 010624	TRW Ø1 25,4 Ø2 20,6
530 d	135	08/98→09/00		09/98→; + DSC		24.2025-1704.3 010619	Ø 25,4
				09/98→; - DSC		24.2025-1705.3 010624	TRW Ø1 25,4 Ø2 20,6
540 i	210	04/97→12/03		09/97→ 07/03		24.2025-1704.3 010619	Ø 25,4
				05/97→ 08/97		24.2120-1721.3 010553	Ø 20,6
BMW - 5 Touring (E61) 03/04→12/10							
 Hauptbremszylinder							
520 d	110 - 130	09/05→05/10				24.2026-1702.3 010850	TRW Ø 27 Ø2 22,2
523 i	140	03/07→01/10					
525 d	145	03/07→05/10					
525 d xDrive	145	09/08→05/10					
525 xd	145	09/07→09/08					
530 d xDrive	173	09/07→05/10					
530 i xDrive	200	09/08→05/10					
530 xd	173	03/07→08/07					
530 xi	200	09/06→05/10					
520 d	120	04/05→05/10		07/05→		24.2026-1702.3 010850	TRW Ø 27 Ø2 22,2
530 d	170	02/05→02/07					
530 xd	170	02/05→02/07					
530 xi	190	04/05→02/07					
520 i	120 - 125	07/07→12/10		→ 05/10		24.2026-1702.3 010850	TRW Ø 27 Ø2 22,2
525 i xDrive	160	09/08→12/10					
525 xi	160	07/05→12/10					
550 i	270	07/05→12/10					
M5	373	02/07→12/10					
523 i	130	10/04→02/07		07/05→		24.2025-1710.3 010833	TRW Ø 25,4
530 i	190	09/04→02/07					
523 i	140	01/07→12/10		03/07→ 05/10		24.2026-1702.3 010850	TRW Ø 27 Ø2 22,2
530 i	200	01/07→12/10					
535 d	210	01/07→12/10					
525 d	120	03/04→03/07		12/04→		24.2026-1702.3 010850	TRW Ø 27 Ø2 22,2
525 d	130	03/04→03/07		05/04→		24.2026-1702.3 010850	TRW Ø 27 Ø2 22,2
530 d	155 - 160	03/04→05/10					
525 i	141	06/04→12/10		→ 03/05		24.2025-1710.3 010833	TRW Ø 25,4
→							































	kw			 	! #		
BMW - 5 Touring (E61) 03/04→12/10							
 Hauptbremszylinder							
525 i	155	03/05→05/10		→ 03/07		24.2025-1710.3 010833	TRW Ø 25,4
				03/07→		24.2026-1702.3 010850	TRW Ø 27 Ø2 22,2
525 i	160	03/05→05/10		07/05→ 03/07		24.2025-1710.3 010833	TRW Ø 25,4
				03/07→		24.2026-1702.3 010850	TRW Ø 27 Ø2 22,2
525 i	155 - 160	01/07→12/10		→ 03/07		24.2025-1710.3 010833	TRW Ø 25,4
				03/07→ 05/10		24.2026-1702.3 010850	TRW Ø 27 Ø2 22,2
530 d	173	02/07→05/10		03/07→		24.2026-1702.3 010850	TRW Ø 27 Ø2 22,2
530 i	200	09/06→03/10					
535 d	200	09/04→12/10		→ 03/07		24.2026-1702.3 010850	TRW Ø 27 Ø2 22,2
545 i	245	06/04→12/10		→ 08/05		24.2026-1702.3 010850	TRW Ø 27 Ø2 22,2
BMW - 5 Touring (F11) 11/09→02/17							
 Hauptbremszylinder							
518 d	100 - 120	07/13→02/17				24.2026-1706.3 011040	TRW Ø 27 Ø2 22,2
520 d	140 - 155	07/14→02/17					
520 d xDrive	100 - 155	07/13→02/17					
520 i	120	09/11→02/17					
525 d	150 - 160	09/10→02/17					
525 d xDrive	155 - 160	07/13→02/17					
528 i	180	09/11→02/17					
528 i xDrive	180	09/11→02/17					
530 d	190	09/11→02/17					
530 d xDrive	190	03/11→02/17					
535 d	220 - 230	09/10→02/17					
535 d xDrive	230	09/11→02/17					
535 i xDrive	225	09/11→02/17					
550 i	330	07/13→02/17					
M 550 d xDrive	280	03/12→02/17					
520 d	100 - 147	06/10→02/17		09/10→		24.2026-1706.3 011040	TRW Ø 27 Ø2 22,2
523 i	150	11/09→08/11					
528 i	190	11/09→08/11					
530 d	180	06/10→08/11					
535 i	225	06/10→02/17					
520 i	135	10/10→02/17		09/11→		24.2026-1706.3 011040	TRW Ø 27 Ø2 22,2
530 i	190 - 200	03/10→06/13					
550 i	300	09/10→06/13					
530 d	210	09/11→02/17		10/15→		24.2026-1706.3 011040	TRW Ø 27 Ø2 22,2
530 d xDrive	210	03/11→02/17					
535 i	240	07/13→02/17					
535 i xDrive	240	07/13→02/17					
BMW - 6 (E63) 09/03→12/10							
 Hauptbremszylinder							
630 i	190 - 200	09/04→08/10				24.2026-1702.3 010850	TRW Ø 27 Ø2 22,2
645 Ci	245	09/03→08/05					
650 i	270	09/05→08/10					
M	373	09/05→07/10					
635 d	210	07/07→07/10		09/07→		24.2026-1702.3 010850	TRW Ø 27 Ø2 22,2
BMW - 6 Cabriolet (E64) 03/04→12/10							
 Hauptbremszylinder							
630 i	190 - 200	09/04→08/10				24.2026-1702.3 010850	TRW Ø 27 Ø2 22,2
645 Ci	245	04/04→08/05					
650 i	270	09/05→08/10					
M6	373	09/06→08/10					
635 d	210	07/07→07/10		09/07→		24.2026-1702.3 010850	TRW Ø 27 Ø2 22,2
BMW - 6 Cabriolet (F12) 12/10→06/18							
 Hauptbremszylinder							
640 d	230	09/11→06/18				24.2026-1706.3 011040	TRW Ø 27 Ø2 22,2
640 d xDrive	230	03/12→06/18					
640 i	235	09/11→06/18					
640 i xDrive	235	03/13→06/18					
→							



















	kw					! #		
BMW - 6 Cabriolet (F12) 12/10→06/18								
 Hauptbremszylinder								
650 i	298 - 330	12/10→06/18					24.2026-1706.3 011040	TRW Ø 27 Ø2 22,2
650 i xDrive	300	09/11→06/12						
650 i xDrive	330	07/12→06/18		09/12→			24.2026-1706.3 011040	TRW Ø 27 Ø2 22,2
BMW - 6 Coupe (F13) 07/11→10/17								
 Hauptbremszylinder								
640 d	230	09/11→10/17					24.2026-1706.3 011040	TRW Ø 27 Ø2 22,2
640 d xDrive	230	03/12→10/17						
640 i	235	07/11→10/17						
640 i xDrive	235	03/13→10/17						
650 i	298 - 300	07/11→12/12						
650 i xDrive	300	09/11→02/15						
650 i	330	07/12→10/17		09/12→			24.2026-1706.3 011040	TRW Ø 27 Ø2 22,2
650 i xDrive	330	07/12→10/17						
BMW - 6 Gran Coupe (F06) 03/12→10/18								
 Hauptbremszylinder								
640 d	230	03/12→10/18					24.2026-1706.3 011040	TRW Ø 27 Ø2 22,2
640 d xDrive	230	03/13→10/18						
640 i	235	03/12→10/18						
640 i xDrive	235	03/13→10/18						
650 i	330	07/12→10/18						
650 i xDrive	330	07/12→10/18						
BMW - 7 (E38) 03/94→11/01								
 Hauptbremszylinder								
725 tds	105	04/96→11/01		09/98→			24.2025-1704.3 010619	Ø 25,4
				09/97→ 08/98			24.2025-1705.3 010624	TRW Ø1 25,4 Ø2 20,6
				05/96→ 08/97			24.2120-1721.3 010553	Ø 20,6
iL	142	08/95→11/01		09/98→			24.2025-1704.3 010619	Ø 25,4
728 i	142	08/95→11/01		09/97→ 08/98			24.2025-1705.3 010624	TRW Ø1 25,4 Ø2 20,6
				→ 08/97			24.2120-1721.3 010553	Ø 20,6
				01/96→ 08/97			24.2120-1721.3 010553	Ø 20,6
730 d	135	08/98→04/00		09/98→; + DSC			24.2025-1704.3 010619	Ø 25,4
				09/98→; - DSC			24.2025-1705.3 010624	TRW Ø1 25,4 Ø2 20,6
730 d	142	04/00→11/01		+ DSC			24.2025-1704.3 010619	Ø 25,4
740 d	180	05/99→11/01		- DSC			24.2025-1705.3 010624	TRW Ø1 25,4 Ø2 20,6
730 i	155	10/94→11/01		09/98→			24.2025-1704.3 010619	Ø 25,4
iL	155 - 240	10/94→11/01		09/97→ 08/98			24.2025-1705.3 010624	TRW Ø1 25,4 Ø2 20,6
740 i	210	02/96→07/01		→ 08/97			24.2120-1721.3 010553	Ø 20,6
750 i	240	11/94→07/01						
iL	175	09/98→07/01					24.2025-1704.3 010619	Ø 25,4
735 i	175	09/98→07/01						
BMW - 7 (E65, E66, E67) 07/01→12/09								
 Hauptbremszylinder								
730 d	150 - 155	09/02→08/08					24.2026-1701.3 010746	Ø 27 Ø2 20,6
730 Ld	170	07/05→08/08						
735 i	200 - 225	11/01→12/09						
Li	200 - 270	07/01→08/08						
740 d	190	10/02→02/05						
740 i	225	03/05→08/08						
745 d	220 - 242	03/05→07/08						
745 i	245	07/01→03/05						
750 i	270	03/05→08/08						
730 d	160	06/02→02/05		09/02→			24.2026-1701.3 010746	Ø 27 Ø2 20,6
730 i	170	03/03→07/08					24.2026-1701.3 010746	Ø 27 Ø2 20,6
Li	170	03/03→07/08					24.2026-1705.3 010992	TRW Ø 27 Ø2 20,6
730 i	184 - 190	03/05→08/08		07/05→			24.2026-1701.3 010746	Ø 27 Ø2 20,6
Li	184 - 190	03/05→08/08						
760 i	320 - 327	01/03→08/08		03/03→			24.2026-1701.3 010746	Ø 27 Ø2 20,6
Li	327	01/03→08/08						





























	kw			 	! #		
BMW - 7 (F01, F02, F03, F04) 02/08→12/15							
 Hauptbremszylinder							
730 d	155	02/08→05/15		09/08→		24.2026-1702.3 010850	TRW Ø 27 Ø2 22,2
730 d	180 - 190	09/08→05/15				24.2026-1702.3 010850	TRW Ø 27 Ø2 22,2
730 i Li	190 - 400	09/09→06/15 09/08→12/15					
740 d	225 - 230	09/09→06/15					
740 d xDrive	225 - 230	09/10→06/15					
740 i	224 - 240	09/08→12/15					
Li xDrive	235 - 330	09/09→12/15					
750 d xDrive	280	07/12→12/15					
750 i	300 - 331	09/08→06/15					
760 i	400	09/09→12/15					
730 d xDrive	155 - 190	11/11→05/15		06/12→		24.2026-1702.3 010850	TRW Ø 27 Ø2 22,2
BMW - X1 (E84) 03/09→06/15							
 Bremskraftverstärker							
sDrive 16 d	85	04/12→06/15		07/12→; für Fahrzeuge ohne Start-Stopp-Funktion		03.7845-0103.4 300268	ATE Ø 8" pneumatisch
sDrive 16 i	105	03/13→06/15		Automatikgetriebe		03.7845-0103.4 300268	ATE Ø 8" pneumatisch
sDrive 18 d xDrive 18 d	100	03/09→06/15		10/09→; für Fahrzeuge ohne Start-Stopp-Funktion		03.7845-0103.4 300268	ATE Ø 8" pneumatisch
sDrive 18 d sDrive 18 i	105 - 110	12/09→06/15 03/10→06/15		für Fahrzeuge ohne Start-Stopp-Funktion		03.7845-0103.4 300268	ATE Ø 8" pneumatisch
sDrive 20 d	120 - 135	10/09→06/15					
sDrive 20 i	135	09/11→06/15					
sDrive 28 i	180	09/12→06/15					
xDrive 18 d	105	10/09→06/15					
xDrive 20 d	120 - 135	09/09→06/15					
xDrive 20 i	135	09/11→06/15					
xDrive 25 i	160	03/10→08/11					
xDrive 28 i	180 - 194	09/09→06/15					
xDrive 35 i	225	03/11→06/15					
xDrive 23 d	150	10/09→06/15		für Fahrzeuge ohne Start-Stopp-Funktion		03.7848-5003.4 300236	ATE Ø 8" pneumatisch
xDrive 25 d	160	10/09→06/15		07/12→; Automatikgetriebe		03.7845-0103.4 300268	ATE Ø 8" pneumatisch
 Hauptbremszylinder							
sDrive 16 d xDrive 25 d	85 - 160	04/12→06/15 10/09→06/15		07/12→; für Linkslenker		03.2025-1904.3 010797	ATE Ø1 25,4 Ø2 22,2
sDrive 16 i	105	03/13→06/15				03.2025-1904.3 010797	ATE Ø1 25,4 Ø2 22,2
sDrive 18 d xDrive 18 d	100	03/09→06/15		10/09→; für Linkslenker		03.2025-1904.3 010797	ATE Ø1 25,4 Ø2 22,2
sDrive 18 d sDrive 18 i	105 - 110	12/09→06/15 03/10→06/15		für Linkslenker		03.2025-1904.3 010797	ATE Ø1 25,4 Ø2 22,2
sDrive 20 d	120 - 135	10/09→06/15					
sDrive 20 i	135	09/11→06/15					
sDrive 28 i	180	09/12→06/15					
xDrive 18 d	105	10/09→06/15					
xDrive 20 d	120 - 135	09/09→06/15					
xDrive 20 i	135	09/11→06/15					
xDrive 23 d	150	10/09→06/15					
xDrive 25 i	160	03/10→08/11					
xDrive 28 i	180 - 194	09/09→06/15					
xDrive 35 i	225	03/11→06/15					
BMW - X1 (F48) 11/14→12/22							
 Hauptbremszylinder							
sDrive 16 d sDrive 18 d xDrive 18 d	85 - 100	11/14→05/22 07/15→06/22 11/14→06/22		09/15→		24.4123-1733.3 011108	Ø 23,8 ohne Bremsflüssigkeitsbehälter
xDrive 20 i	110						
xDrive 20 i	141	07/15→06/22					
xDrive 25 d	170	11/14→05/22					
xDrive 25 i	170	07/15→10/21					
→							















	kW			 	! #		
BMW - X1 (F48) 11/14→12/22							
 Hauptbremszylinder							
sDrive 18 d sDrive 18 i	110 100 - 103	07/15→06/22 11/15→06/22				24.4123-1733.3 011108	Ø 23,8 ohne Bremsflüssigkeitsbehälter
sDrive 20 d sDrive 20 i	120 - 140 131 - 141	11/15→05/22 07/15→06/22					
xDrive 20 d xDrive 20 i xDrive 25 e Plug-in-Hybrid	140 131 - 162	07/15→06/22 11/20→06/22 03/20→06/22					
xDrive 20 d	120	07/15→06/22		11/15→		24.4123-1733.3 011108	Ø 23,8 ohne Bremsflüssigkeitsbehälter
BMW - X1 Van (F48) 07/15→06/22							
 Hauptbremszylinder							
sDrive 18 d sDrive 18 i sDrive 20 d sDrive 20 i xDrive 20 d	110 103 140 141 140	07/15→06/22 07/17→06/22 11/15→05/22 07/17→06/22 07/15→06/22				24.4123-1733.3 011108	Ø 23,8 ohne Bremsflüssigkeitsbehälter
BMW - X2 (F39) 11/17→10/23							
 Hauptbremszylinder							
sDrive 16 d sDrive 18 d	85 100 - 110	11/18→10/23 03/18→10/23				24.4123-1733.3 011108	Ø 23,8 ohne Bremsflüssigkeitsbehälter
sDrive 18 i sDrive 20 d sDrive 20 i	100 - 103 120 - 140 131 - 141	03/18→10/23 11/18→10/23 11/17→10/23					
xDrive 18 d xDrive 20 d xDrive 20 i xDrive 25 d xDrive 25 e Plug-in-Hybrid	100 - 110 120 - 140 131 - 141 170 - 162	03/18→10/23 11/17→10/23 03/18→10/23 11/17→09/23 03/20→10/23					
BMW - X3 (E83) 01/03→12/11							
 Hauptbremszylinder							
2.0 d 2.0 i 2.0 sd 2.5 i 2.5 si 2.5 si xDrive 3.0 d 3.0 i xDrive 3.0 sd 3.0 si xDrive 20 d xDrive 25 i xDrive 30 d xDrive 30 i	110 110 130 141 160 155 150 - 160 170 210 194 - 200 120 - 130 155 - 160 155 - 160 160 - 200	09/04→08/07 07/05→08/08 09/07→08/08 03/04→07/06 08/06→08/08 08/06→08/08 01/04→08/08 09/03→07/06 09/06→08/08 08/06→08/08 09/08→08/10 09/08→08/10 09/08→08/10 08/06→08/10				24.2025-1710.3 010833	TRW Ø 25,4
xDrive 18 d xDrive 20 i xDrive 35 d	100 - 105 110 210	09/08→12/11 09/08→08/11 09/08→08/11		→ 08/10		24.2025-1710.3 010833	TRW Ø 25,4
BMW - X3 (F25) 09/10→12/17							
 Hauptbremszylinder							
sDrive 18 d sDrive 20 i xDrive 20 d →	100 - 110 125 - 135 120 - 140	10/12→08/17 04/14→08/17 09/10→08/17				24.4125-1709.3 011077	TRW Ø 25,4 ohne Bremsflüssigkeitsbehälter











	kw			 	! #		
BMW - X3 (F25) 09/10→12/17							
 Hauptbremszylinder							
xDrive 20 i xDrive 28 i	135 180 - 190	10/11→08/17 01/11→08/17				24.4125-1709.3 011077	TRW Ø 25,4 ohne Bremsflüssigkeitsbehälter
xDrive 30 d xDrive 35 d xDrive 35 i	155 - 210 230 225	04/11→08/17 10/11→08/17 09/10→08/17					
BMW - X4 (F26) 05/13→03/18							
 Hauptbremszylinder							
xDrive 20 d xDrive 20 i xDrive 28 i	120 - 140 135 179 - 180	04/14→03/18 04/14→03/18 04/14→03/18				24.4125-1709.3 011077	TRW Ø 25,4 ohne Bremsflüssigkeitsbehälter
xDrive 30 d xDrive 35 d xDrive 35 i	155 - 210 230 225	04/14→03/18 04/14→03/18 04/14→03/18					
BMW - X5 (E53) 01/00→12/06							
 Hauptbremszylinder							
3.0 d 3.0 i 4.4 i	135 170 210	04/01→09/03 04/00→10/06 01/00→09/03		→ 08/01 09/01→		24.2025-1704.3 010619 24.2025-1707.3 010691	Ø 25,4 Ø 25,4
3.0 d 4.4 i 4.6 is 4.8 is	155 - 160 235 255 265	10/03→09/06 10/03→10/06 10/01→09/03 04/04→09/06				24.2025-1707.3 010691	Ø 25,4
BMW - Z3 Coupe (E36) 04/97→06/03							
 Bremskraftverstärker							
2.8 i 3.0 i	142 170	01/98→05/00 06/00→06/03		→ 12/02		03.7760-3102.4 300139 03.7760-3102.4 300139	ATE Ø 10" pneumatisch ATE Ø 10" pneumatisch
BMW - Z3 Roadster (E36) 10/95→01/03							
 Bremskraftverstärker							
1.9 i 3.0 i	85 - 87 170	07/98→01/03 06/00→01/03		→ 12/02		03.7760-3102.4 300139	ATE Ø 10" pneumatisch
1.9 i 2.2 i 2.5 i 2.8 i	103 125 141 142	11/95→03/99 10/00→06/02 10/00→08/02 11/96→05/00				03.7760-3102.4 300139	ATE Ø 10" pneumatisch
2.0 i 2.2 i	110 120	04/99→01/03 08/00→01/03		→ 08/00 10/00→ 12/02		03.7760-3102.4 300139 03.7760-3102.4 300139	ATE Ø 10" pneumatisch ATE Ø 10" pneumatisch
BMW - Z4 Coupe (E86) 03/06→01/09							
 Bremskraftverstärker							
3.0 si	195	04/06→08/08				03.7860-0702.4 300123	ATE Ø 10" pneumatisch
 Hauptbremszylinder							
3.0 si	195	04/06→08/08				03.2023-2256.3 010870	ATE Ø1 23,8 Ø2 22,2
BMW - Z4 Roadster (E85) 09/02→12/09							
 Bremskraftverstärker							
2.0 i 2.2 i 2.5 i 2.5 si 3.0 i 3.0 si	110 125 141 160 170 195	03/05→02/09 10/03→10/05 12/02→12/05 01/06→08/08 12/02→12/05 01/06→08/08		04/05→ 12/08		03.7860-0702.4 300123 03.7860-0702.4 300123	ATE Ø 10" pneumatisch ATE Ø 10" pneumatisch
2.5 i 2.5 si	130 155	09/05→02/09 09/05→02/09		01/06→ 12/08		03.7860-0702.4 300123	ATE Ø 10" pneumatisch
 Hauptbremszylinder							
2.0 i 2.2 i 2.5 i 3.0 i	110 125 141 170	03/05→02/09 10/03→10/05 12/02→12/05 12/02→12/05		04/05→ 12/08		03.2023-2249.3 010869 03.2023-2249.3 010869	ATE Ø1 23,8 Ø2 22,2 ATE Ø1 23,8 Ø2 22,2
2.5 i	130	09/05→02/09		01/06→ 12/08		03.2023-2256.3 010870	ATE Ø1 23,8 Ø2 22,2
→							

	kw					! #		
BMW - Z4 Roadster (E85) 09/02→12/09								
 Hauptbremszylinder								
2.5 si	155	09/05→02/09		01/06→12/08			03.2023-2256.3 010870	ATE Ø1 23,8 Ø2 22,2
2.5 si	160	01/06→08/08					03.2023-2256.3 010870	ATE Ø1 23,8 Ø2 22,2
3.0 si	195	01/06→08/08						
BMW - Z4 Roadster (E89) 02/09→08/16								
 Hauptbremszylinder								
sDrive 18 i	115	04/13→08/16					03.2025-5826.3 010960	ATE Ø1 25,4 Ø2 22,2
sDrive 20 i	120 - 135	09/11→08/16						
sDrive 23 i	150	03/09→08/11						
sDrive 28 i	180	09/11→08/16						
sDrive 30 i	190 - 195	02/09→08/11						
sDrive 35 i	225	02/09→08/16						
sDrive 35 is	250	03/10→08/16						
BMW - Z8 Roadster (E52) 01/00→12/03								
 Hauptbremszylinder								
4.9	294	01/00→12/03					24.2026-1705.3 010992	TRW Ø 27 Ø2 20,6
CHEVROLET - ASTRA Schrägheck 09/98→12/11								
 Hauptbremszylinder								
2.0 DTi	74	08/02→12/11		→ 07/05; - ESP			24.2123-1734.3 010640	TRW Ø 23,8
				→ 07/05; + ESP			24.2123-1739.3 010661	Ø 23,8
 Bremskraftregler								
2.0 DTi	74	08/02→12/11		→ 07/05			03.6583-0085.3 320238	ATE lastabhängig 8/3 4x
CHEVROLET - ASTRA Stufenheck 10/98→12/11								
 Hauptbremszylinder								
2.0 DTi GLS	74	08/02→12/11		→ 07/05; - ESP			24.2123-1734.3 010640	TRW Ø 23,8
				→ 07/05; + ESP			24.2123-1739.3 010661	Ø 23,8
 Bremskraftregler								
2.0 DTi GLS	74	08/02→12/11		→ 07/05			03.6583-0085.3 320238	ATE lastabhängig 8/3 4x
CHEVROLET - AVEO Schrägheck (T300) 03/11→								
 Hauptbremszylinder								
1.2	51 - 63	03/11→		→ 03/12; Felgenreöße [Zoll]: 14; für Linkslenker; + ABS			24.4122-1735.3 011113	Ø 22,2 ohne Bremsflüssigkeitsbehälter
1.3 D	55 - 70	07/11→12/15		04/12→; Felgenreöße [Zoll]: 15; für Linkslenker; + ESP			24.4123-1738.3 011124	Ø 23,8 ohne Bremsflüssigkeitsbehälter
1.4	74	03/11→		→ 03/12; Felgenreöße [Zoll]: 15; für Linkslenker; - ESP			24.4123-1738.3 011124	Ø 23,8 ohne Bremsflüssigkeitsbehälter
1.6	85	03/11→						
1.2 LPG	63	11/12→12/15		Felgenreöße [Zoll]: 15; für Linkslenker; + ESP			24.4123-1738.3 011124	Ø 23,8 ohne Bremsflüssigkeitsbehälter
CHEVROLET - AVEO Stufenheck (T300) 03/11→								
 Hauptbremszylinder								
1.2	51 - 63	03/11→		→ 03/12; Felgenreöße [Zoll]: 14; für Linkslenker; + ABS			24.4122-1735.3 011113	Ø 22,2 ohne Bremsflüssigkeitsbehälter
1.3 D	55 - 70	07/11→12/15		04/12→; Felgenreöße [Zoll]: 15; für Linkslenker; + ESP			24.4123-1738.3 011124	Ø 23,8 ohne Bremsflüssigkeitsbehälter
1.4	74 - 103	07/11→		→ 03/12; Felgenreöße [Zoll]: 15; für Linkslenker; - ESP			24.4123-1738.3 011124	Ø 23,8 ohne Bremsflüssigkeitsbehälter
1.6	85	03/11→						
1.2 LPG	63	11/12→12/15		Felgenreöße [Zoll]: 15; für Linkslenker; + ESP			24.4123-1738.3 011124	Ø 23,8 ohne Bremsflüssigkeitsbehälter
CHEVROLET - CORSA Kombi 01/96→12/10								
 Hauptbremszylinder								
1.7 D	44	08/00→07/02		→ 09/00; für Linkslenker; - ABS			24.2120-0702.3 010361	nicht für Delco Ø 20,6
				→ 09/00; für Linkslenker; + ABS			24.2120-1714.3 010455	Ø 20,6
CHEVROLET - CRUZE (J300) 05/09→								
 Bremskraftverstärker								
1.4	74 - 103	09/10→		für Linkslenker			03.7858-0732.4 300272	ATE Ø 9 / 8" pneumatisch













	kW			 	! #		
CHEVROLET - CRUZE (J300) 05/09→							
 Bremskraftverstärker							
1.6	80 - 91	05/09→		für Linkslenker		03.7858-0732.4 300272	ATE Ø 9 / 8" pneumatisch
1.7 D	96	01/12→					
1.7 TD	81	11/13→					
1.8	103 - 104	05/09→					
1.8 LPG	104	06/11→					
2.0 CDI	92 - 120	05/09→					
2.0 VCDi	122	03/12→11/18					
 Hauptbremszylinder							
1.4	74	07/13→		für Linkslenker; + ESP		03.2125-0421.3 010934	ATE Ø 25,4
1.6	80 - 91	05/09→		für Rechtslenker; + ESP		24.4155-0201.3 011125	ATE Ø 25,4 ohne Bremsflüssigkeitsbehälter
1.7 D	96	01/12→					
1.7 TD	81	11/13→					
1.8	103 - 104	05/09→					
1.8 LPG	104	06/11→					
2.0 CDI	92 - 120	05/09→					
2.0 VCDi	122	03/12→11/18					
1.4	103	09/10→		für Linkslenker; + ESP		03.2125-0421.3 010934	ATE Ø 25,4
1.6	86	12/12→		für Linkslenker; für Fahrzeuge mit elektr. Dämpferregulierung		03.2125-0421.3 010934	ATE Ø 25,4
CHEVROLET - CRUZE Schrägheck (J305) 12/10→							
 Bremskraftverstärker							
1.4	74	07/13→12/15		für Linkslenker		03.7858-0732.4 300272	ATE Ø 9 / 8" pneumatisch
1.6	80 - 91	06/11→					
1.7 D	96	01/12→12/15					
1.7 TD	81	08/13→12/15					
1.8	103 - 104	06/11→					
1.8 LPG	104	06/11→12/15					
2.0 CDI	120	06/11→					
1.4	103	06/12→		08/12→; für Linkslenker		03.7858-0732.4 300272	ATE Ø 9 / 8" pneumatisch
 Hauptbremszylinder							
1.4	74	07/13→12/15		für Linkslenker; + ESP		03.2125-0421.3 010934	ATE Ø 25,4
1.6	80 - 91	06/11→		für Rechtslenker; + ESP		24.4155-0201.3 011125	ATE Ø 25,4 ohne Bremsflüssigkeitsbehälter
1.7 D	96	01/12→12/15					
1.7 TD	81	08/13→12/15					
1.8	103 - 104	06/11→					
1.8 LPG	104	06/11→12/15					
2.0 CDI	120	06/11→					
1.4	103	06/12→		08/12→; für Linkslenker; + ESP		03.2125-0421.3 010934	ATE Ø 25,4
				08/12→; für Rechtslenker; + ESP		24.4155-0201.3 011125	ATE Ø 25,4 ohne Bremsflüssigkeitsbehälter
CHEVROLET - CRUZE Station Wagon (J308) 08/12→							
 Bremskraftverstärker							
1.4	74 - 103	08/12→		für Linkslenker		03.7858-0732.4 300272	ATE Ø 9 / 8" pneumatisch
1.6	86 - 91	08/12→12/15					
1.7 TD	81 - 96	08/12→					
1.8	104	08/12→					
2.0 TD	120	08/12→					
 Hauptbremszylinder							
1.4	74 - 103	08/12→		für Linkslenker; + ESP		03.2125-0421.3 010934	ATE Ø 25,4
1.6	86 - 91	08/12→12/15		für Rechtslenker; + ESP		24.4155-0201.3 011125	ATE Ø 25,4 ohne Bremsflüssigkeitsbehälter
1.7 TD	81 - 96	08/12→					
1.8	104	08/12→					
2.0 TD	120	08/12→					

	kW			 	! #		
CHEVROLET - MALIBU (V300) 01/12→							
 Bremskraftverstärker							
2.0 2.0 D 2.4 3.0	193 115 - 118 123 - 125 196	01/12→12/15 04/12→ 01/12→ 04/13→				03.7858-0732.4 300272	ATE Ø 9 / 8" pneumatisch
 Hauptbremszylinder							
2.0 2.0 D 2.4 3.0	193 115 - 118 123 - 125 196	01/12→12/15 04/12→ 01/12→ 04/13→				03.2125-0421.3 010934	ATE Ø 25,4
CHEVROLET - MATIZ (M200, M250) 03/05→							
 Hauptbremszylinder							
0.8 0.8 LPG 1.0 1.0 LPG	37 38 47 49	10/10→ 03/05→12/07 03/05→12/07 03/05→03/11		→ 645871; + ABS		24.2120-1755.3 010974	Ø 20,6 ohne Bremsflüssigkeitsbehälter
				645872→; + ABS		24.2120-1755.3 010974	Ø 20,6 ohne Bremsflüssigkeitsbehälter
				→ 645871; - ABS		24.2120-1765.3 011003	Ø 20,6 ohne Bremsflüssigkeitsbehälter
				645872→; - ABS		24.2120-1765.3 011003	Ø 20,6 ohne Bremsflüssigkeitsbehälter
0.8 1.0	38 46 - 49	03/05→12/13 03/05→		645872→; → 12/10; + ABS		24.2120-1755.3 010974	Ø 20,6 ohne Bremsflüssigkeitsbehälter
				→ 645871; + ABS		24.2120-1755.3 010974	Ø 20,6 ohne Bremsflüssigkeitsbehälter
				645872→; → 12/10; - ABS		24.2120-1765.3 011003	Ø 20,6 ohne Bremsflüssigkeitsbehälter
				→ 645871; - ABS		24.2120-1765.3 011003	Ø 20,6 ohne Bremsflüssigkeitsbehälter
CHEVROLET - ORLANDO (J309) 12/10→							
 Bremskraftverstärker							
1.8 1.8 LPG 2.0 D 2.0 LPG	104 104 96 - 120 103	02/11→ 06/11→12/15 02/11→ 02/12→				03.7858-0732.4 300272	ATE Ø 9 / 8" pneumatisch
 Hauptbremszylinder							
1.4	103	06/12→		+ ESP		24.4155-0201.3 011125	ATE Ø 25,4 ohne Bremsflüssigkeitsbehälter
1.8 1.8 LPG 2.0 D 2.0 LPG	104 104 96 - 120 103	02/11→ 06/11→12/15 02/11→ 02/12→		+ ESP		03.2125-0421.3 010934	ATE Ø 25,4
CHEVROLET - SPARK 05/05→							
 Hauptbremszylinder							
0.8	37	05/05→02/10		645872→; für Linkslenker; Schaltgetriebe; + ABS		24.2120-1755.3 010974	Ø 20,6 ohne Bremsflüssigkeitsbehälter
				→ 645871; für Linkslenker; Schaltgetriebe; + ABS		24.2120-1755.3 010974	Ø 20,6 ohne Bremsflüssigkeitsbehälter
				645872→; für Linkslenker; Schaltgetriebe; - ABS		24.2120-1765.3 011003	Ø 20,6 ohne Bremsflüssigkeitsbehälter
				→ 645871; für Linkslenker; Schaltgetriebe; - ABS		24.2120-1765.3 011003	Ø 20,6 ohne Bremsflüssigkeitsbehälter
1.0 SX	44 - 49	05/05→		645872→; → 02/10; für Linkslenker; + ABS		24.2120-1755.3 010974	Ø 20,6 ohne Bremsflüssigkeitsbehälter
				→ 645871; für Linkslenker; + ABS		24.2120-1755.3 010974	Ø 20,6 ohne Bremsflüssigkeitsbehälter
				645872→; → 02/10; für Linkslenker; - ABS		24.2120-1765.3 011003	Ø 20,6 ohne Bremsflüssigkeitsbehälter
				→ 645871; für Linkslenker; - ABS		24.2120-1765.3 011003	Ø 20,6 ohne Bremsflüssigkeitsbehälter

	kw					! #		
CHEVROLET - SPARK Kasten/Schrägheck (M200, M250) 01/05→08/14								
 Hauptbremszylinder								
0.8	38	01/07→08/14		645872→; für Linkslenker; Schaltgetriebe; + ABS		24.2120-1755.3	010974	Ø 20,6 ohne Bremsflüssigkeitsbehälter
				→ 645871; für Linkslenker; Schaltgetriebe; + ABS		24.2120-1755.3	010974	Ø 20,6 ohne Bremsflüssigkeitsbehälter
				645872→; für Linkslenker; Schaltgetriebe; - ABS		24.2120-1765.3	011003	Ø 20,6 ohne Bremsflüssigkeitsbehälter
				→ 645871; für Linkslenker; Schaltgetriebe; - ABS		24.2120-1765.3	011003	Ø 20,6 ohne Bremsflüssigkeitsbehälter
CHEVROLET - TIGRA 08/97→09/01								
 Hauptbremszylinder								
1.6	73	09/98→12/99		- ABS		24.2120-0702.3	010361	nicht für Delco Ø 20,6
				+ ABS		24.2120-1714.3	010455	Ø 20,6
CHEVROLET - TRAX 12/12→								
 Hauptbremszylinder								
1.4	103	12/12→		für Linkslenker		24.4123-1738.3	011124	Ø 23,8 ohne Bremsflüssigkeitsbehälter
1.4 AWD	103	12/12→						
1.4 LPG	103	04/13→						
1.6	85	12/12→						
1.6 D	100	11/14→12/15						
1.6 D AWD	100	11/14→12/15						
1.7 TD	96	12/12→						
1.7 TD AWD	96	12/12→						
1.8	103	03/13→						
1.8 AWD	103	03/13→						
CHEVROLET - VECTRA 03/96→11/06								
 Hauptbremszylinder								
2.2	108	04/02→04/04		für Linkslenker; + ESP		24.2125-1732.3	010827	TRW Ø 25,4
3.2	155	09/01→07/04						
CHRYSLER - DELTA 08/11→								
 Hauptbremszylinder								
1.4	88	08/11→				24.4123-1710.3	010866	BOS Ø 23,8 ohne Bremsflüssigkeitsbehälter
1.4 16V	103	08/11→						
1.6 D Multijet	88	08/11→						
2.0 D Multijet	121	08/11→						
CHRYSLER - VOYAGER / GRAND VOYAGER III (GS_, NS_) 01/95→03/01								
 Hauptbremszylinder								
2.0 i	98	01/95→03/01		für Fahrzeuge mit STC		24.2123-1781.3	011060	Ø 23,8 ohne Bremsflüssigkeitsbehälter
2.4 AWD	111	02/97→03/01						
2.4 i	111	01/95→03/01						
3.0	112	01/95→03/01						
3.3 i	116	01/95→03/01						
3.8 i AWD	122 - 131	01/95→03/01						
2.5 TD	85	01/95→03/01		für Fahrzeuge ohne STC		24.2123-1781.3	011060	Ø 23,8 ohne Bremsflüssigkeitsbehälter
2.5 TDiC AWD	85	10/95→03/01						
CHRYSLER - VOYAGER / GRAND VOYAGER IV (RG) 02/00→02/08								
 Hauptbremszylinder								
2.8 CRD	110	04/04→02/08		für Linkslenker; - ESP		24.2123-1781.3	011060	Ø 23,8 ohne Bremsflüssigkeitsbehälter
CHRYSLER - VOYAGER IV (RG, RS) 09/99→12/08								
 Hauptbremszylinder								
2.4	108	02/00→12/08		02/02→; für Linkslenker; - ESP		24.2126-1706.3	011062	Ø 26 ohne Bremsflüssigkeitsbehälter
				02/02→; für Linkslenker; + ESP		24.2126-1707.3	011061	Ø 26 ohne Bremsflüssigkeitsbehälter
2.4	111	04/03→12/07		für Linkslenker; - ESP		24.2126-1706.3	011062	Ø 26 ohne Bremsflüssigkeitsbehälter
3.3	128 - 131	02/00→12/08						
3.8	160	02/00→12/08		für Linkslenker; + ESP		24.2126-1707.3	011061	Ø 26 ohne Bremsflüssigkeitsbehälter
2.5 CRD	88	08/05→12/08		für Linkslenker; - ESP		24.2123-1781.3	011060	Ø 23,8 ohne Bremsflüssigkeitsbehälter
2.5 CRD	105	02/00→12/08		10/02→; für Linkslenker; - ESP		24.2123-1781.3	011060	Ø 23,8 ohne Bremsflüssigkeitsbehälter
→								

	kw					! #		
CHRYSLER - VOYAGER IV (RG, RS) 09/99→12/08								
 Hauptbremszylinder								
2.5 CRD	105	02/00→12/08		→ 09/02; für Linkslenker; - ESP			24.2126-1706.3 011062	Ø 26 ohne Bremsflüssigkeitsbehälter
				→ 09/02; für Linkslenker; + ESP			24.2126-1707.3 011061	Ø 26 ohne Bremsflüssigkeitsbehälter
3.3 AWD 3.8 AWD	128 160	02/00→12/08 02/00→12/08		für Linkslenker			24.2126-1706.3 011062	Ø 26 ohne Bremsflüssigkeitsbehälter
CITROËN - BERLINGO / BERLINGO FIRST Großraumlimousine (MF_, GJK_, GFK_ 07/96→								
 Hauptbremszylinder								
1.1 i 1.4 i	44 55	07/96→05/08 07/96→12/11		Orga 08610→; → 03/08; - ABS			03.2123-2781.3 010631	ATE Ø 23,8
				→Orga 08609; - ABS			24.2123-1714.3 010587	BDX Ø 23,8
				→Orga 08609; für Linkslenker; + ABS			24.2123-1710.3 010504	Ø 23,8
				Orga 08610→; → 03/08; - ESP			24.2123-1713.3 010505	Ø 23,8
				Orga 08610→; → 03/08; - ESP			24.2123-1715.3 010520	BDX Ø 23,8
1.4 2.0 HDi 4x4 2.0 HDi 90 electrique	53 66 66 16	11/02→10/05 11/02→10/05 12/99→10/05 01/00→10/02		- ABS			03.2123-2781.3 010631	ATE Ø 23,8
				- ESP			24.2123-1714.3 010587	BDX Ø 23,8
				- ESP			24.2123-1715.3 010520	BDX Ø 23,8
1.4 bivalent 1.4 i bivalent 1.6 16V	48 55 80 - 81	11/02→12/11 04/03→10/08 10/00→12/11		→ 03/08; - ABS			03.2123-2781.3 010631	ATE Ø 23,8
				→ 03/08; - ESP			24.2123-1714.3 010587	BDX Ø 23,8
				→ 03/08; - ESP			24.2123-1715.3 010520	BDX Ø 23,8
1.6 HDi 75 1.6 HDi 90	55 66	07/05→12/11 07/05→05/08						
1.6 HDi 92	68	11/09→12/10		- ABS			24.2123-1714.3 010587	BDX Ø 23,8
				+ ABS / - ESP			24.2123-1715.3 010520	BDX Ø 23,8
1.8 D 1.8 i 1.9 D	43 66 50 - 51	07/98→10/02 05/97→10/02 07/96→10/05		Orga 08610→; - ABS			03.2123-2781.3 010631	ATE Ø 23,8
				→Orga 08609; - ABS			24.2123-1714.3 010587	BDX Ø 23,8
				→Orga 08609; für Linkslenker; + ABS			24.2123-1710.3 010504	Ø 23,8
1.9 D 4WD	51	07/98→10/05		→Orga 08609; für Linkslenker; + ABS			24.2123-1713.3 010505	Ø 23,8
				Orga 08610→; - ESP			24.2123-1715.3 010520	BDX Ø 23,8
1.8 i 4WD	66	04/97→10/01		Orga 08610→; - ABS			03.2123-2781.3 010631	ATE Ø 23,8
				05/97→; →Orga 08609; - ABS			24.2123-1714.3 010587	BDX Ø 23,8
				05/97→; →Orga 08609; für Linkslenker; + ABS			24.2123-1710.3 010504	Ø 23,8
				Orga 08610→; - ESP			24.2123-1713.3 010505	Ø 23,8
				Orga 08610→; - ESP			24.2123-1715.3 010520	BDX Ø 23,8
Electric	28	01/98→12/05		11/02→; - ABS			03.2123-2781.3 010631	ATE Ø 23,8
				11/02→; - ESP			24.2123-1714.3 010587	BDX Ø 23,8
				11/02→; - ESP			24.2123-1715.3 010520	BDX Ø 23,8
CITROËN - BERLINGO / BERLINGO FIRST Kasten/Großraumlimousine (M_) 07/96→12/11								
 Hauptbremszylinder								
1.1 i 1.4 BiFuel 1.8 D 1.9 D 1.9 D 70 4WD 2.0 HDi 90 4WD	44 55 43 51 51 66	07/96→03/08 07/96→10/02 07/96→10/02 07/96→12/03 07/98→03/06 11/00→10/05		Orga 08610→; - ABS			03.2123-2781.3 010631	ATE Ø 23,8
				→Orga 08609; - ABS			24.2123-1714.3 010587	BDX Ø 23,8
				→Orga 08609; - ABS			24.2123-1710.3 010504	Ø 23,8
				→Orga 08609; + ABS; für Linkslenker			24.2123-1713.3 010505	Ø 23,8
				Orga 08610→; + ABS			24.2123-1715.3 010520	BDX Ø 23,8
1.4 bivalent 1.6 HDi 75	48 55	11/02→12/11 07/05→12/11		→ 03/08; - ABS			03.2123-2781.3 010631	ATE Ø 23,8
				→ 03/08; + ABS			24.2123-1714.3 010587	BDX Ø 23,8
				→ 03/08; + ABS			24.2123-1715.3 010520	BDX Ø 23,8
1.4 i 1.9 D 70 2.0 HDi 90	55 51 66	07/96→12/11 04/99→12/11 12/99→12/11		Orga 08610→; → 03/08; - ABS			03.2123-2781.3 010631	ATE Ø 23,8
				→Orga 08609; - ABS			24.2123-1714.3 010587	BDX Ø 23,8
				→Orga 08609; + ABS; für Linkslenker			24.2123-1710.3 010504	Ø 23,8
				→Orga 08609; + ABS; für Linkslenker			24.2123-1713.3 010505	Ø 23,8
				Orga 08610→; → 03/08; + ABS			24.2123-1715.3 010520	BDX Ø 23,8
1.4 i bivalent 1.6 16V	55 80 - 81	04/03→10/05 10/00→03/08		- ABS			03.2123-2781.3 010631	ATE Ø 23,8
				+ ABS			24.2123-1714.3 010587	BDX Ø 23,8
				+ ABS			24.2123-1715.3 010520	BDX Ø 23,8
1.6 HDi 92	68	11/09→12/10		- ABS			24.2123-1714.3 010587	BDX Ø 23,8
				+ ABS / - ESP			24.2123-1715.3 010520	BDX Ø 23,8
Electric	42	01/10→12/10		+ ESP			24.4123-1714.3 010979	TRW Ø 23,8



	kW					! #		
CITROËN - BERLINGO Kasten/Großraumlimousine (B9) 04/08→								
 Hauptbremszylinder								
1.6	66 - 80	04/08→		+ ESP			24.4123-1714.3 010979	TRW Ø 23,8
1.6 BlueHDi 100	73	12/14→						
1.6 BlueHDi 100 4x4	73	12/14→						
1.6 BlueHDi 120	88	12/14→						
1.6 HDi 110	80 - 82	04/08→						
1.6 HDi 115	84	07/10→						
1.6 HDi 115 4x4	84	02/12→						
1.6 HDi 75	55	04/08→						
1.6 HDi 75 4x4	55	02/12→						
1.6 HDi 90	66 - 68	07/10→						
1.6 HDi 90 16V	66	04/08→						
1.6 HDi 90 4x4	66	02/12→						
1.6 VTi 120	88	11/09→						
1.6 VTi 95	72	07/10→						
Electric	49	01/13→						
1.6 HDi / BlueHDi 75	55	07/10→		04/15→; + ESP			24.4123-1714.3 010979	TRW Ø 23,8
Electric	35	01/13→		02/13→; + ESP			24.4123-1714.3 010979	TRW Ø 23,8
PureTech 110	81	01/18→		+ ESP; →Orga 14685			24.4123-1714.3 010979	TRW Ø 23,8
CITROËN - BERLINGO MULTISPACE (B9) 04/08→								
 Hauptbremszylinder								
1.2 PureTech 110	81	02/16→		+ ESP			24.4123-1714.3 010979	TRW Ø 23,8
1.6	66 - 81	04/08→						
1.6 BlueHDi 100	73	12/14→						
1.6 BlueHDi 120	88	12/14→						
1.6 HDi 110	80 - 82	04/08→						
1.6 HDi 115	84	07/10→						
1.6 HDi 115 4x4	84	02/12→						
1.6 HDi 75 16V	55	04/08→						
1.6 HDi 90	66 - 68	04/08→						
1.6 HDi 90 4x4	66	02/12→12/14						
1.6 VTi 120	88	11/09→						
1.6 VTi 95	72	07/10→						
1.6 HDi 75 / BlueHDi 75	55	04/08→		04/15→; + ESP			24.4123-1714.3 010979	TRW Ø 23,8
Electric	49	09/17→		+ ESP; →Orga 14685			24.4123-1714.3 010979	TRW Ø 23,8
CITROËN - BERLINGO Pritsche/Fahrgestell (B9) 04/08→								
 Hauptbremszylinder								
1.6 BlueHDi 100	73	12/14→		+ ESP			24.4123-1714.3 010979	TRW Ø 23,8
1.6 HDi 90	66	07/10→						
1.6 HDi 90 16V	66	04/08→						
1.6 HDi 92	68	07/10→12/17						
CITROËN - C1 (PM_, PN_) 06/05→09/14								
 Hauptbremszylinder								
1.0	50	06/05→09/14		für Linkslenker; → 04/14; - ESP			24.4120-1701.3 010846	BOS Ø 20,6
				für Linkslenker; → 04/14; + ESP			24.4120-1704.3 011042	Ø 20,6 ohne Bremsflüssigkeitsbehälter
				für Rechtslenker; → 04/14; + ESP			24.4120-1705.3 011051	Ø 20,6 ohne Bremsflüssigkeitsbehälter
1.4 HDi	40	06/05→09/14		→ 12/08; für Linkslenker; - ESP			24.4120-1701.3 010846	BOS Ø 20,6
				→ 12/08; für Linkslenker; + ESP			24.4120-1704.3 011042	Ø 20,6 ohne Bremsflüssigkeitsbehälter
				→ 12/08; für Rechtslenker; + ESP			24.4120-1705.3 011051	Ø 20,6 ohne Bremsflüssigkeitsbehälter
CITROËN - C1 II (PA_, PS_) 04/14→								
 Hauptbremszylinder								
1.0 VTi 68	51	04/14→		für Linkslenker; - ESP			24.4120-1712.3 011092	Ø 20,6 ohne Bremsflüssigkeitsbehälter
1.0 VTi 72	53	06/18→						
1.2 VTi 82	60	04/14→						
CITROËN - C2 (JM_) 07/03→09/17								
 Hauptbremszylinder								
1.1	44	09/03→09/12		→ 12/09; - ABS			24.2120-1741.3 010775	Ø 20,6
→				10815→ 11192; für Linkslenker; - ESP			24.2122-1764.3 010851	BOS Ø 22,2

CITROËN - C2 (JM_) 07/03→09/17









 **Hauptbremszylinder**













1.1	44	09/03→09/12	→Orga 10800; - ESP	24.2122-1766.3 010840	TRW Ø 22,2
			→Orga 10800; + ESP	24.2122-1767.3 010841	TRW Ø 22,2 ohne Drucksensor
			Orga 10801→; → 12/09; + ESP	24.4122-1703.3 010843	TRW Ø 22,2
			10801→ 11192; für Rechtslenker; - ESP	24.4122-1704.3 010847	TRW Ø 22,2
			10808→ 10810; für Linkslenker; - ESP	24.4122-1704.3 010847	TRW Ø 22,2
			10801→ 10807; für Linkslenker; - ESP	24.4122-1708.3 010865	BOS Ø 22,2 ohne Bremsflüssigkeitsbehälter
			10811→ 10814; für Linkslenker; - ESP	24.4122-1708.3 010865	BOS Ø 22,2 ohne Bremsflüssigkeitsbehälter
			Orga 11193→; → 12/09; für Linkslenker; - ESP	24.4122-1708.3 010865	BOS Ø 22,2 ohne Bremsflüssigkeitsbehälter
1.4 1.4 HDi	54 - 55 50 - 51	09/03→12/09 07/03→12/09	- ABS	24.2120-1741.3 010775	Ø 20,6
			10815→ 11192; für Linkslenker; - ESP	24.2122-1764.3 010851	BOS Ø 22,2
			→Orga 10800; - ESP	24.2122-1766.3 010840	TRW Ø 22,2
			→Orga 10800; + ESP	24.2122-1767.3 010841	TRW Ø 22,2 ohne Drucksensor
			Orga 10801→; + ESP	24.4122-1703.3 010843	TRW Ø 22,2
			Orga 10801→; für Rechtslenker; - ESP	24.4122-1704.3 010847	TRW Ø 22,2
			10808→ 10810; für Linkslenker; - ESP	24.4122-1704.3 010847	TRW Ø 22,2
			10801→ 10807; für Linkslenker; - ESP	24.4122-1708.3 010865	BOS Ø 22,2 ohne Bremsflüssigkeitsbehälter
1.4 16V	65	04/05→12/09	- ABS	24.2120-1741.3 010775	Ø 20,6
			10815→ 11192; für Linkslenker; - ESP	24.2122-1764.3 010851	BOS Ø 22,2
			Orga 10801→; + ESP	24.4122-1703.3 010843	TRW Ø 22,2
			Orga 10801→; für Rechtslenker; - ESP	24.4122-1704.3 010847	TRW Ø 22,2
			10808→ 10810; für Linkslenker; - ESP	24.4122-1704.3 010847	TRW Ø 22,2
			Orga 11193→; für Linkslenker; - ESP	24.4122-1708.3 010865	BOS Ø 22,2 ohne Bremsflüssigkeitsbehälter
			10801→ 10807; für Linkslenker; - ESP	24.4122-1708.3 010865	BOS Ø 22,2 ohne Bremsflüssigkeitsbehälter
			10811→ 10814; für Linkslenker; - ESP	24.4122-1708.3 010865	BOS Ø 22,2 ohne Bremsflüssigkeitsbehälter
1.6	80	07/03→10/10	→ 12/09; - ABS	24.2120-1741.3 010775	Ø 20,6
			→Orga 10800; - ESP	24.2122-1766.3 010840	TRW Ø 22,2
			→Orga 10800; + ESP	24.2122-1767.3 010841	TRW Ø 22,2 ohne Drucksensor
			Orga 10801→; → 12/09; + ESP	24.4122-1703.3 010843	TRW Ø 22,2
			Orga 10801→; → 12/09; für Linkslenker; - ESP	24.4122-1704.3 010847	TRW Ø 22,2
1.6 HDi	80	09/05→12/09	Orga 10801→; + ESP	24.4122-1703.3 010843	TRW Ø 22,2
1.6 VTS	90	10/04→12/09	→Orga 10800; - ESP	24.2122-1766.3 010840	TRW Ø 22,2
			→Orga 10800; + ESP	24.2122-1767.3 010841	TRW Ø 22,2 ohne Drucksensor
			Orga 10801→; + ESP	24.4122-1703.3 010843	TRW Ø 22,2













CITROËN - C2 ENTERPRISE (JG_) 11/03→12/09













 **Hauptbremszylinder**















1.1	44	11/03→12/09	- ABS	24.2120-1741.3 010775	Ø 20,6
			10815→ 11192; für Linkslenker; - ESP	24.2122-1764.3 010851	BOS Ø 22,2
			→Orga 10800; - ESP	24.2122-1766.3 010840	TRW Ø 22,2
			→Orga 10800; + ESP	24.2122-1767.3 010841	TRW Ø 22,2 ohne Drucksensor
			Orga 10801→; + ESP	24.4122-1703.3 010843	TRW Ø 22,2
			10808→ 10810; für Linkslenker; - ESP	24.4122-1704.3 010847	TRW Ø 22,2
			10801→ 11192; für Rechtslenker; - ESP	24.4122-1704.3 010847	TRW Ø 22,2
			10801→ 10807; für Linkslenker; - ESP	24.4122-1708.3 010865	BOS Ø 22,2 ohne Bremsflüssigkeitsbehälter
			10811→ 10814; für Linkslenker; - ESP	24.4122-1708.3 010865	BOS Ø 22,2 ohne Bremsflüssigkeitsbehälter
1.4 HDi	50 - 51	11/03→12/09	- ABS	24.2120-1741.3 010775	Ø 20,6
			10815→ 11192; für Linkslenker; - ESP	24.2122-1764.3 010851	BOS Ø 22,2
			→Orga 10800; - ESP	24.2122-1766.3 010840	TRW Ø 22,2
			→		











	kw			 	! #		
CITROËN - C2 ENTERPRISE (JG_) 11/03→12/09							
 Hauptbremszylinder							
1.4 HDi	50 - 51	11/03→12/09		→Orga 10800; + ESP	24.2122-1767.3	010841	TRW Ø 22,2 ohne Drucksensor
				Orga 10801→; + ESP	24.4122-1703.3	010843	TRW Ø 22,2
				Orga 10801→; für Rechtslenker; - ESP	24.4122-1704.3	010847	TRW Ø 22,2
				10808→ 10810; für Linkslenker; - ESP	24.4122-1704.3	010847	TRW Ø 22,2
				10801→ 10807; für Linkslenker; - ESP	24.4122-1708.3	010865	BOS Ø 22,2 ohne Bremsflüssigkeitsbehälter
				Orga 11193→; für Linkslenker; - ESP	24.4122-1708.3	010865	BOS Ø 22,2 ohne Bremsflüssigkeitsbehälter
				10811→ 10814; für Linkslenker; - ESP	24.4122-1708.3	010865	BOS Ø 22,2 ohne Bremsflüssigkeitsbehälter
CITROËN - C3 I (FC_, FN_) 02/02→							
 Hauptbremszylinder							
1.1 i 1.4 HDi 1.4 i	44 50 - 55 54	02/02→ 02/02→ 02/02→11/10		→ 08/09; - ABS	24.2120-1741.3	010775	Ø 20,6
				Orga 10815→; → 08/09; für Linkslenker; - ESP	24.2122-1764.3	010851	BOS Ø 22,2
				→Orga 10800; für Linkslenker; - ESP	24.2122-1764.3	010851	BOS Ø 22,2
				→Orga 10800; - ESP	24.2122-1766.3	010840	TRW Ø 22,2
				→Orga 10800; + ESP	24.2122-1767.3	010841	TRW Ø 22,2 ohne Drucksensor
				Orga 10801→; → 08/09; + ESP	24.4122-1703.3	010843	TRW Ø 22,2
				10808→ 10814; für Linkslenker; - ESP	24.4122-1704.3	010847	TRW Ø 22,2
				→ 08/09; für Rechtslenker; - ESP	24.4122-1704.3	010847	TRW Ø 22,2
				10801→ 10807; für Linkslenker; - ESP	24.4122-1708.3	010865	BOS Ø 22,2 ohne Bremsflüssigkeitsbehälter
1.1 LPG 1.4 1.4 BiFuel 1.4 i Bivalent	44 58 54 49	06/06→12/09 12/05→07/12 09/08→12/09 01/08→12/09		- ABS	24.2120-1741.3	010775	Ø 20,6
				Orga 10815→; für Linkslenker; - ESP	24.2122-1764.3	010851	BOS Ø 22,2
				→Orga 10800; für Linkslenker; - ESP	24.2122-1764.3	010851	BOS Ø 22,2
				→Orga 10800; - ESP	24.2122-1766.3	010840	TRW Ø 22,2
				→Orga 10800; + ESP	24.2122-1767.3	010841	TRW Ø 22,2 ohne Drucksensor
				Orga 10801→; + ESP	24.4122-1703.3	010843	TRW Ø 22,2
				10808→ 10814; für Linkslenker; - ESP	24.4122-1704.3	010847	TRW Ø 22,2
				für Rechtslenker; - ESP	24.4122-1704.3	010847	TRW Ø 22,2
				10801→ 10807; für Linkslenker; - ESP	24.4122-1708.3	010865	BOS Ø 22,2 ohne Bremsflüssigkeitsbehälter
1.4 16V 1.6 16V	65 80	12/03→ 02/02→08/10		→ 08/09; - ABS	24.2120-1741.3	010775	Ø 20,6
				→Orga 10800; für Linkslenker; - ESP	24.2122-1764.3	010851	BOS Ø 22,2
				→Orga 10800; - ESP	24.2122-1766.3	010840	TRW Ø 22,2
				→Orga 10800; + ESP	24.2122-1767.3	010841	TRW Ø 22,2 ohne Drucksensor
				Orga 10801→; → 08/09; + ESP	24.4122-1703.3	010843	TRW Ø 22,2
				→ 08/09; - ESP	24.4122-1704.3	010847	TRW Ø 22,2
1.4 16V HDi	66	02/02→		→ 08/09; - ABS	24.2120-1741.3	010775	Ø 20,6
				Orga 10815→; → 08/09; für Linkslenker; - ESP	24.2122-1764.3	010851	BOS Ø 22,2
				→Orga 10800; für Linkslenker; - ESP	24.2122-1764.3	010851	BOS Ø 22,2
				→Orga 10800; - ESP	24.2122-1766.3	010840	TRW Ø 22,2
				→Orga 10800; + ESP	24.2122-1767.3	010841	TRW Ø 22,2 ohne Drucksensor
				Orga 10801→; → 08/09; + ESP	24.4122-1703.3	010843	TRW Ø 22,2
				→ 08/09; - ESP	24.4122-1704.3	010847	TRW Ø 22,2
				10801→ 10807; für Linkslenker; - ESP	24.4122-1708.3	010865	BOS Ø 22,2 ohne Bremsflüssigkeitsbehälter
1.4 i Bivalent	54	02/02→		09/05→ 08/09; - ABS	24.2120-1741.3	010775	Ø 20,6
				09/05→; →Orga 10800; für Linkslenker; - ESP	24.2122-1764.3	010851	BOS Ø 22,2
				09/05→; →Orga 10800; - ESP	24.2122-1766.3	010840	TRW Ø 22,2
				09/05→; →Orga 10800; + ESP	24.2122-1767.3	010841	TRW Ø 22,2 ohne Drucksensor
				Orga 10801→; → 08/09; + ESP	24.4122-1703.3	010843	TRW Ø 22,2
				09/05→ 08/09; für Linkslenker; - ESP	24.4122-1704.3	010847	TRW Ø 22,2
				10801→ 10807; für Linkslenker; - ESP	24.4122-1708.3	010865	BOS Ø 22,2 ohne Bremsflüssigkeitsbehälter
1.6 16V	81	05/03→09/05		- ABS	24.2120-1741.3	010775	Ø 20,6
				→Orga 10800; für Linkslenker; - ESP	24.2122-1764.3	010851	BOS Ø 22,2
				→Orga 10800; - ESP	24.2122-1766.3	010840	TRW Ø 22,2
				→Orga 10800; + ESP	24.2122-1767.3	010841	TRW Ø 22,2 ohne Drucksensor
→							















	kw					! #		
CITROËN - C3 I (FC_, FN_) 02/02→								
 Hauptbremszylinder								
1.6 16V	81	05/03→09/05		Orga 10801→; + ESP		24.4122-1703.3 010843		TRW Ø 22,2
				- ESP		24.4122-1704.3 010847		TRW Ø 22,2
1.6 16V HDi	66	10/05→		→Orga 10800; für Linkslenker; - ESP		24.2122-1764.3 010851		BOS Ø 22,2
				→Orga 10800; - ESP		24.2122-1766.3 010840		TRW Ø 22,2
				→Orga 10800; + ESP		24.2122-1767.3 010841		TRW Ø 22,2 ohne Drucksensor
				Orga 10801→; → 08/09; + ESP		24.4122-1703.3 010843		TRW Ø 22,2
				→ 08/09; - ESP		24.4122-1704.3 010847		TRW Ø 22,2
1.6 16V HDi	80	09/05→		→Orga 10800; für Linkslenker; - ESP		24.2122-1764.3 010851		BOS Ø 22,2
				→Orga 10800; - ESP		24.2122-1766.3 010840		TRW Ø 22,2
				→Orga 10800; + ESP		24.2122-1767.3 010841		TRW Ø 22,2 ohne Drucksensor
				Orga 10801→; → 08/09; + ESP		24.4122-1703.3 010843		TRW Ø 22,2
				→ 08/09; - ESP		24.4122-1704.3 010847		TRW Ø 22,2
				10801→ 10807; für Linkslenker; - ESP		24.4122-1708.3 010865		BOS Ø 22,2 ohne Bremsflüssigkeitsbehälter
CITROËN - C3 II (SC_) 09/09→								
 Hauptbremszylinder								
1.1 BiFuel	44	11/10→		Orga 13153→; + DSC		24.4122-1703.3 010843		TRW Ø 22,2
1.1 i	44	09/09→01/13		Orga 13153→; - DSC		24.4122-1704.3 010847		TRW Ø 22,2
1.4	54	11/09→09/16						
1.4 HDi 70	50	11/09→						
1.4 LPG	54	07/10→						
1.6 HDi 90	66	11/09→						
1.4 VTi	72	11/09→		Orga 13153→; + DSC		24.4123-1704.3 010828		TRW Ø 23,8
1.4 VTi 95	70	11/09→		Orga 13153→; - DSC		24.4123-1705.3 010832		TRW Ø 23,8
1.6 HDi 110	82	11/09→						
1.6 HDi 115	84	09/12→						
1.6 VTi 120	88	11/09→						
1.6 BlueHDi 100	73	07/14→		+ DSC		24.4122-1703.3 010843		TRW Ø 22,2
1.6 BlueHDi 75	55	04/15→		- DSC		24.4122-1704.3 010847		TRW Ø 22,2
1.6 HDi	68	11/09→09/16		Orga 13153→; Trommelbremse; + DSC		24.4122-1703.3 010843		TRW Ø 22,2
				Orga 13153→; Trommelbremse; - DSC		24.4122-1704.3 010847		TRW Ø 22,2
				Orga 13153→; Scheibenbremse; + DSC		24.4123-1704.3 010828		TRW Ø 23,8
				Orga 13153→; Scheibenbremse; - DSC		24.4123-1705.3 010832		TRW Ø 23,8
CITROËN - C3 II Kasten/Schrägheck (SC_) 06/10→								
 Hauptbremszylinder								
1.4 HDi	50	06/10→09/16		Orga 13153→; + DSC		24.4122-1703.3 010843		TRW Ø 22,2
				Orga 13153→; - DSC		24.4122-1704.3 010847		TRW Ø 22,2
1.6 BlueHDi	55	03/15→09/16		+ DSC		24.4122-1703.3 010843		TRW Ø 22,2
				- DSC		24.4122-1704.3 010847		TRW Ø 22,2
CITROËN - C3 III (SX) 07/16→								
 Hauptbremszylinder								
1.2 PureTech 82	61	05/18→		für Fahrzeuge mit Trommelbremse an der Hinterachse		24.4122-1703.3 010843		TRW Ø 22,2
1.2 PureTech 82 LPG	61	05/18→						
1.2 THP 110	81	07/16→		für Fahrzeuge mit Scheibenbremse an der Hinterachse		24.4123-1704.3 010828		TRW Ø 23,8
1.2 VTi 68	50	07/16→						
1.2 VTi 82	60	07/16→						
1.2 VTi 82 LPG	60	07/16→						
1.5 BlueHDi 100	75	05/18→						
1.6 BlueHDi 100	73	07/16→						
1.6 BlueHDi 75	55	07/16→						
1.6 VTi	85	02/17→						
CITROËN - C3 III Van (SX_, SY_) 07/16→								
 Hauptbremszylinder								
1.2 VTi	60	07/16→		für Fahrzeuge mit Trommelbremse an der Hinterachse		24.4122-1703.3 010843		TRW Ø 22,2
BlueHDi 100	73 - 75	03/19→						
BlueHDi 75	55	03/19→						
PureTech 110	81	03/19→		für Fahrzeuge mit Scheibenbremse an der Hinterachse		24.4123-1704.3 010828		TRW Ø 23,8
PureTech 82	61	03/19→						
CITROËN - C3 AIRCROSS II (2R_, 2C_) 06/17→								
 Hauptbremszylinder								
1.2 PureTech 110	81	06/17→				24.4123-1704.3 010828		TRW Ø 23,8
1.2 PureTech 130	96	07/17→						
1.2 PureTech 82	60	06/17→						













	kw					! #		
CITROËN - C3 AIRCROSS II (2R_, 2C_) 06/17→								
 Hauptbremszylinder								
1.5 BlueHDi 100	73	08/18→					24.4123-1704.3 010828	TRW Ø 23,8
	75							
1.5 BlueHDi 110	81	10/20→						
1.5 BlueHDi 120	88	08/18→						
1.6 BlueHDi 100	73	07/17→						
1.6 BlueHDi 115	85	06/17→						
1.6 BlueHDi 120	88	07/17→						
1.6 HDi 92	68	10/17→						
CITROËN - C3 AIRCROSS II Van (2C_, 2R_) 06/17→								
 Hauptbremszylinder								
1.5 BlueHDi 100	73	05/19→					24.4123-1704.3 010828	TRW Ø 23,8
1.5 BlueHDi 120	88	05/19→						
1.6 BlueHDi 100	73	05/19→						
PureTech 82	60	05/19→						
	81							
CITROËN - C3 PICASSO (SH_) 02/09→								
 Hauptbremszylinder								
1.2 THP 110	81	01/15→			+ ESP		24.4123-1704.3 010828	TRW Ø 23,8
1.4 VTi 95	70	02/09→			- ESP		24.4123-1705.3 010832	TRW Ø 23,8
1.4 VTi 95 LPG	70	01/12→						
1.6 BlueHDi 100	73	01/15→						
1.6 HDi	66	02/09→						
	80							
1.6 HDi 110	82	05/10→						
1.6 HDi 115	84	01/13→						
1.6 HDi 90	68	07/10→						
1.6 VTi 120	88	02/09→						
1.6 VTi	84	07/09→			10/16→; + ESP		24.4123-1704.3 010828	TRW Ø 23,8
					10/16→; - ESP		24.4123-1705.3 010832	TRW Ø 23,8
CITROËN - C3 Pluriel (HB_) 05/03→								
 Hauptbremszylinder								
1.4	54	05/03→			→ 07/10; - ABS		24.2120-1741.3 010775	Ø 20,6
	55							
1.4 HDi	50	04/04→			→ Orga 10800; - ESP		24.2122-1764.3 010851	BOS Ø 22,2
							24.2122-1766.3 010840	TRW Ø 22,2
					→ Orga 10800; + ESP		24.2122-1767.3 010841	TRW Ø 22,2 ohne Drucksensor
					Orga 10801→; → 07/10; + ESP		24.4122-1703.3 010843	TRW Ø 22,2
					Orga 10801→; → 07/10; - ESP		24.4122-1704.3 010847	TRW Ø 22,2
1.6	80	05/03→			→ 07/10; - ABS		24.2120-1741.3 010775	Ø 20,6
							24.2122-1764.3 010851	BOS Ø 22,2
					→ Orga 10800; - ESP		24.2122-1766.3 010840	TRW Ø 22,2
							24.2122-1767.3 010841	TRW Ø 22,2 ohne Drucksensor
					Orga 10801→; → 07/10; + ESP		24.4122-1703.3 010843	TRW Ø 22,2
					Orga 10801→; → 07/10; - ESP		24.4122-1704.3 010847	TRW Ø 22,2
CITROËN - C4 I (LC_) 11/04→12/14								
 Hauptbremszylinder								
1.4 16V	65	11/04→07/11			Orga 11193→; - ESP		24.4123-1730.3 011097	Ø 23,8 ohne Bremsflüssigkeitsbehälter
1.6 16V	80	11/04→07/11						
1.6 16V Bio-Flex	80	09/07→07/08						
1.6 HDi	66	11/04→07/11						
	85							
1.6 HDi	80	04/10→11/12			- ESP		24.4123-1730.3 011097	Ø 23,8 ohne Bremsflüssigkeitsbehälter
	84							
1.6 THP 140	103	07/08→07/11						
1.6 THP 150	110	07/08→07/11						
1.6 VTi 120	88	07/08→07/11						
2.0 16V	103	11/04→07/11			Orga 11242→; - ESP		24.4123-1730.3 011097	Ø 23,8 ohne Bremsflüssigkeitsbehälter
	130							
CITROËN - C4 I Stufenheck 07/06→								
 Hauptbremszylinder								
1.6	81	03/11→			Orga 11193→; - ESP		24.4123-1730.3 011097	Ø 23,8 ohne Bremsflüssigkeitsbehälter
1.6 16V	80	07/06→07/11						
1.6 HDi	80	07/06→08/13						
	85							
1.6 HDi	80	04/10→11/12			- ESP		24.4123-1730.3 011097	Ø 23,8 ohne Bremsflüssigkeitsbehälter
	84							
2.0 16V	103	07/06→07/11			Orga 11242→; - ESP		24.4123-1730.3 011097	Ø 23,8 ohne Bremsflüssigkeitsbehälter













	kw			 	! #		
CITROËN - C4 CACTUS 09/14→							
 Hauptbremszylinder							
1.2 PureTech 130 1.2 THP 110	96 81	11/17→ 09/14→		für Fahrzeuge mit Trommelbremse an der Hinterachse		24.4122-1703.3 010843	TRW Ø 22,2
1.2 VTi 75 / PureTech 75 1.2 VTi 82 1.5 BlueHDi 100	55 60 73 - 75	09/14→ 09/14→ 06/18→		für Fahrzeuge mit Scheibenbremse an der Hinterachse		24.4123-1704.3 010828	TRW Ø 23,8
1.5 BlueHDi 120 1.6 BlueHDi 100 1.6 HDi 90	88 73 68	09/18→ 09/14→ 09/14→					
CITROËN - C4 CACTUS Van (0B_, 0P_) 09/14→							
 Hauptbremszylinder							
BlueHDi 100 PureTech 110 PureTech 130 PureTech 82	73 81 96 60	05/19→ 05/19→ 05/19→ 05/19→		für Fahrzeuge mit Trommelbremse an der Hinterachse		24.4122-1703.3 010843	TRW Ø 22,2
				für Fahrzeuge mit Scheibenbremse an der Hinterachse		24.4123-1704.3 010828	TRW Ø 23,8
CITROËN - C4 Coupe (LA_) 11/04→12/13							
 Hauptbremszylinder							
1.4 16V 1.6 16V 1.6 HDi	65 80 66 - 80	11/04→07/11 11/04→07/11 11/04→07/11		Orga 11193→; - ESP		24.4123-1730.3 011097	Ø 23,8 ohne Bremsflüssigkeitsbehälter
1.6 THP 1.6 THP 150 1.6 VTi 120	103 110 88	06/08→07/11 07/08→07/11 07/08→07/11		- ESP		24.4123-1730.3 011097	Ø 23,8 ohne Bremsflüssigkeitsbehälter
2.0 16V 2.0 VTR	130 103	11/04→12/10 10/06→12/07		Orga 11242→; - ESP		24.4123-1730.3 011097	Ø 23,8 ohne Bremsflüssigkeitsbehälter
CITROËN - C4 GRAND PICASSO I (UA_) 10/06→12/13							
 Bremskraftverstärker							
1.6 16V 1.6 HDi 1.6 HDi 110 1.6 THP 155 1.6 VTi 120 2.0 HDi 138 2.0 HDi 150 2.0 HDi 165	103 - 110 80 82 115 88 100 110 120	07/08→08/13 10/06→06/11 09/10→08/13 09/10→08/13 07/08→08/13 10/06→12/13 07/09→08/13 09/10→08/13				03.7860-4034.4 300318	ATE Ø 10" pneumatisch
1.8 i 16V 1.8 i 16V CNG 1.8 i 16V Flex	92 86 86	10/06→12/10 03/09→12/11 06/09→01/13				03.7870-1002.4 300282	ATE Ø 11" pneumatisch
2.0 i 16V	103 - 105	10/06→12/13		→ 07/13		03.7870-1002.4 300282	ATE Ø 11" pneumatisch
 Hauptbremszylinder							
1.6 16V 1.6 HDi 1.8 i 16V 1.8 i 16V CNG 1.8 i 16V Flex	103 80 92 86 86	07/08→12/10 10/06→06/11 10/06→12/10 03/09→12/11 06/09→01/13				03.4153-0173.3 010815	ATE Ø 23,8
1.6 16V 1.6 HDi 110 1.6 VTi 120 2.0 HDi 138 2.0 HDi 150 2.0 i 16V	110 82 88 100 110 103 - 105	10/08→08/13 09/10→08/13 07/08→08/13 10/06→12/13 07/09→08/13 10/06→12/13		→ 07/13		03.4153-0173.3 010815	ATE Ø 23,8
1.6 THP 155 2.0 HDi 165	115 120	09/10→08/13 09/10→08/13		11/10→ 07/13		03.4153-0173.3 010815	ATE Ø 23,8
CITROËN - C4 GRAND PICASSO II (DA_, DE_) 06/13→							
 Hauptbremszylinder							
1.2 THP 130 1.6 BlueHDi 100 1.6 BlueHDi 120 1.6 HDi / BlueHDi 115 1.6 HDi 90 1.6 THP 150 1.6 THP 155 1.6 THP 165 1.6 VTi 120 2.0 BlueHDi 135	96 73 88 85 68 110 115 121 88 100	04/14→ 01/15→ 07/14→ 09/13→ 09/13→ 09/14→ 09/13→ 07/14→ 09/13→ 09/13→				24.4155-1311.3 011053	ATE Ø 25,4 ohne Bremsflüssigkeitsbehälter
2.0 BlueHDi 150	110	06/13→		09/13→		24.4155-1311.3 011053	ATE Ø 25,4 ohne Bremsflüssigkeitsbehälter









	kw					! #			
CITROËN - C4 PICASSO I Großraumlimousine (UD_) 10/06→12/15									
 Bremskraftverstärker									
1.6 16V	110	07/08→08/13					03.7860-4034.4	300318	ATE Ø 10" pneumatisch
1.6 HDi	80	02/07→08/13							
1.6 HDi 110	82	09/10→08/13							
1.6 THP 140	103	07/08→08/13							
1.6 THP 155	115	09/10→08/13							
1.6 VTi 120	88	07/08→08/13							
2.0 HDi 138	100	10/06→08/13							
2.0 HDi 150	110	07/09→08/13							
2.0 HDi 165	120	09/10→08/13							
1.8 Bifuel	92	01/09→10/12					03.7870-1002.4	300282	ATE Ø 11" pneumatisch
1.8 i 16V	92	02/07→12/11							
2.0 i 16V	105	05/08→05/13							
2.0 i 16V	103	09/07→08/13		→ 07/13			03.7870-1002.4	300282	ATE Ø 11" pneumatisch
 Hauptbremszylinder									
1.6 16V	110	07/08→08/13		→ 07/13			03.4153-0173.3	010815	ATE Ø 23,8
1.6 HDi	80	02/07→08/13							
1.6 THP 140	103	07/08→08/13							
1.6 VTi 120	88	07/08→08/13							
2.0 HDi 150	110	07/09→08/13							
2.0 i 16V	103	09/07→08/13							
1.6 HDi 110	82	09/10→08/13		11/10→ 07/13			03.4153-0173.3	010815	ATE Ø 23,8
1.6 THP 155	115	09/10→08/13							
2.0 HDi 165	120	09/10→08/13							
1.8 Bifuel	92	01/09→10/12					03.4153-0173.3	010815	ATE Ø 23,8
1.8 i 16V	92	02/07→12/11							
2.0 i 16V	105	05/08→05/13							
2.0 HDi 138	100	10/06→08/13		02/07→ 07/13			03.4153-0173.3	010815	ATE Ø 23,8
CITROËN - C4 PICASSO II 01/13→									
 Hauptbremszylinder									
1.2 THP 110	81	04/16→					24.4155-1311.3	011053	ATE Ø 25,4 ohne Bremsflüssigkeitsbehälter
1.2 THP 130	96	04/14→							
1.6 BlueHDi 100	73	12/14→							
1.6 BlueHDi 120	88	07/14→							
1.6 THP 150	110	09/14→							
1.6 THP 165	121	07/14→							
1.6 VTi 120	88	02/13→							
2.0 BlueHDi 135	100	09/13→							
2.0 BlueHDi 150	110	09/13→							
1.6 HDi / BlueHDi 115	85	02/13→		06/13→			24.4155-1311.3	011053	ATE Ø 25,4 ohne Bremsflüssigkeitsbehälter
1.6 HDi 90	68	02/13→							
1.6 THP 155	115	02/13→							
CITROËN - C4 PICASSO II Van (DD_) 01/13→									
 Hauptbremszylinder									
BlueHDi 150	110	09/13→					24.4155-1311.3	011053	ATE Ø 25,4 ohne Bremsflüssigkeitsbehälter
THP 155	115	02/13→							
VTi 120	88	02/13→							
e-HDi	85	02/13→		08/13→			24.4155-1311.3	011053	ATE Ø 25,4 ohne Bremsflüssigkeitsbehälter
HDi / e-HDi	68	02/13→							
CITROËN - C4 SPACETOURER (3D_) 04/18→									
 Hauptbremszylinder									
1.2 PureTech 110	81	04/18→					24.4155-1311.3	011053	ATE Ø 25,4 ohne Bremsflüssigkeitsbehälter
1.2 PureTech 130	96	04/18→							
1.5 BlueHDi 130	96	05/18→							
1.6 BlueHDi 100	73	04/18→							
1.6 BlueHDi 120	88	04/18→							
1.6 THP 165	121	04/18→							
2.0 BlueHDi 150	110	04/18→							
2.0 BlueHDi 160	120	04/18→							
CITROËN - C4 SPACETOURER Van (3D_) 04/18→									
 Hauptbremszylinder									
BlueHDi 120	88	05/19→					24.4155-1311.3	011053	ATE Ø 25,4 ohne Bremsflüssigkeitsbehälter
BlueHDi 130	96	05/19→							
PureTech 130	96	05/19→							
CITROËN - C5 III (RD_) 02/08→									
 Bremskraftverstärker									
1.6	120	03/11→		für Linklenker			03.7860-7802.4	300280	ATE Ø 10" pneumatisch
1.6 HDi 110	80	02/08→							
1.6 THP 150	110	07/10→							
1.6 THP 155	115	04/09→							
→									

	kw			 	! #		
CITROËN - C5 III (RD_) 02/08 →							
 Bremskraftverstärker							
1.6 VTi 120 1.8 16V 2.0 16V 2.0 16V BioFlex 2.0 HDi 2.0 HDi 140 2.0 HDi 165 2.2 HDi 2.2 HDi 200 2.7 HDi 3.0 HDi 240 3.0 V6	88 92 103 103 100 - 101 103 120 120 - 125 150 150 177 155	07/10 → 02/08 → 02/08 → 02/08 →12/12 02/08 → 11/08 → 04/09 → 02/08 →12/11 125 07/10 → 02/08 → 04/09 →10/14 02/08 →		für Linkslenker		03.7860-7802.4 300280	ATE Ø 10" pneumatisch
1.6 HDi 110 1.6 HDi 115 2.0 HDi 180	82 84 133	07/10 → 01/12 → 03/15 →		für Linkslenker; für Fahrzeuge ohne Start-Stopp-Funktion		03.7860-7802.4 300280	ATE Ø 10" pneumatisch
 Hauptbremszylinder							
1.6 1.6 HDi 110 1.6 THP 150 1.6 THP 155 1.6 VTi 120 1.8 16V 2.0 16V 2.0 16V BioFlex 2.0 HDi 2.0 HDi 140 2.0 HDi 165 2.2 HDi 2.2 HDi 200 2.7 HDi 3.0 HDi 240 3.0 V6	120 80 - 82 110 115 88 92 103 103 100 - 101 103 120 120 - 150 150 177 155	03/11 → 02/08 → 02/08 → 07/10 → 04/09 → 07/10 → 02/08 → 02/08 → 02/08 →12/12 02/08 → 11/08 → 04/09 → 02/08 →12/11 125 07/10 → 02/08 → 04/09 →10/14 02/08 →		Orga 12348 →		03.2123-3131.3 010977	ATE Ø 23,8
1.6 HDi 115 2.0 HDi 150 / BlueHDi 150 2.0 HDi 180	84 110 133	01/12 → 04/09 →02/15 03/15 →				03.2123-3131.3 010977	ATE Ø 23,8
CITROËN - C5 III Break (RW_) 02/08 →							
 Bremskraftverstärker							
1.6 HDi 110 1.6 THP 150 1.6 THP 155 1.6 VTi 120 1.8 16V 2.0 16V 2.0 16V BioFlex 2.0 HDi 2.0 HDi 140 2.0 HDi 150 / BlueHDi 150 2.0 HDi 165 2.2 HDi 2.2 HDi 165 2.2 HDi 200 2.7 HDi 3.0 HDi 240 3.0 V6	80 110 115 88 92 103 103 100 103 110 120 125 120 150 150 177 155	02/08 → 04/09 → 04/09 → 07/10 → 02/08 →12/09 02/08 →12/11 02/08 → 02/08 → 04/09 → 04/09 →02/15 04/09 → 02/08 →12/11 02/08 → 07/10 → 02/08 → 04/09 →10/14 02/08 →12/10		für Linkslenker		03.7860-7802.4 300280	ATE Ø 10" pneumatisch
1.6 HDi 110 1.6 HDi 115 2.0 HDi 180	82 84 133	07/10 → 01/12 → 03/15 →		für Linkslenker; für Fahrzeuge ohne Start-Stopp-Funktion		03.7860-7802.4 300280	ATE Ø 10" pneumatisch
 Hauptbremszylinder							
1.6 HDi 110	80	02/08 →		01/12 →		03.2123-3131.3 010977	ATE Ø 23,8
1.6 HDi 110 1.6 HDi 115 1.6 THP 150 1.6 THP 155 1.6 VTi 120 1.8 16V 2.0 16V 2.0 16V BioFlex 2.0 HDi 2.0 HDi 140	82 84 110 115 88 92 103 103 100 103	07/10 → 01/12 → 04/09 → 04/09 → 07/10 → 02/08 →12/09 02/08 →12/11 02/08 → 02/08 → 04/09 →		Orga 12348 →		03.2123-3131.3 010977	ATE Ø 23,8

	kw					! #		
CITROËN - C5 III Break (RW_) 02/08→								
 Hauptbremszylinder								
2.0 HDi 150 / BlueHDi 150	110	04/09→02/15		Orga 12348→			03.2123-3131.3 010977	ATE Ø 23,8
2.0 HDi 165	120	04/09→						
2.2 HDi	125	02/08→12/11						
2.2 HDi 165	120	02/08→						
2.2 HDi 200	150	07/10→						
2.7 HDi	150	02/08→						
3.0 HDi 240	177	04/09→10/14						
3.0 V6	155	02/08→12/10						
2.0 HDi 180	133	03/15→					03.2123-3131.3 010977	ATE Ø 23,8
CITROËN - C6 (TD_) 09/05→12/12								
 Bremskraftverstärker								
2.2 HDi	120 - 125	06/06→12/12		für Linkslenker; →Orga 11192			03.7860-3402.4 300217	ATE Ø 10" pneumatisch
				Orga 12047→; für Linkslenker			03.7860-8002.4 300258	ATE Ø 10" pneumatisch
2.7 HDi	150	09/05→12/11		→Orga 11073; für Linkslenker			03.7860-3402.4 300217	ATE Ø 10" pneumatisch
3.0 HDi	155	06/09→12/10		für Linkslenker			03.7860-8002.4 300258	ATE Ø 10" pneumatisch
3.0 HDi	177	04/09→12/12		07/09→; für Linkslenker			03.7860-8002.4 300258	ATE Ø 10" pneumatisch
3.0 V6	155	09/05→12/12		für Linkslenker; →Orga 11192			03.7860-3402.4 300217	ATE Ø 10" pneumatisch
 Hauptbremszylinder								
2.2 HDi	120 - 125	06/06→12/12		Orga 12348→			03.2123-3131.3 010977	ATE Ø 23,8
2.7 HDi	150	09/05→12/11						
3.0 HDi	155 - 177	04/09→12/12						
3.0 V6	155	09/05→12/12						
CITROËN - C8 (EA_, EB_) 06/02→								
 Bremskraftverstärker								
2.0 16V	103	09/05→		→Orga 10919; für Linkslenker			03.7860-2002.4 300216	ATE Ø 10" pneumatisch
2.0 HDi 135	100	03/06→		Orga 10920→; für Linkslenker; → 07/14			03.7860-4432.4 300313	ATE Ø 10" pneumatisch
2.0 HDi	79 - 81	07/02→		Orga 10528→; für Linkslenker; → 07/14			03.7860-2002.4 300216	ATE Ø 10" pneumatisch
2.2 HDi	94	07/02→						
2.0 HDi	88	07/06→		02/07→; für Linkslenker; → 07/14			03.7860-4432.4 300313	ATE Ø 10" pneumatisch
 Hauptbremszylinder								
2.0 16V	103	09/05→		→ 07/14			03.2122-2163.3 010800	ATE Ø 22,2
2.0 HDi 135	100	03/06→						
2.0 HDi	79 - 81	07/02→		Orga 10528→; → 07/14			03.2122-2163.3 010800	ATE Ø 22,2
2.2 HDi	94	07/02→						
2.0 HDi	88	07/06→		02/07→ 07/14			03.2122-2163.3 010800	ATE Ø 22,2
2.0 HDi 165	120	03/06→		→ 07/14			03.2123-3421.3 010933	ATE Ø 23,8
2.2 HDi	120	06/07→						
2.2 HDi	125	06/06→12/12					03.2123-3421.3 010933	ATE Ø 23,8
CITROËN - C8 Van (EA_, EB_) 06/02→								
 Bremskraftverstärker								
2.0	103	06/04→12/11		→Orga 10919; für Linkslenker			03.7860-2002.4 300216	ATE Ø 10" pneumatisch
				Orga 10920→; für Linkslenker			03.7860-4432.4 300313	ATE Ø 10" pneumatisch
HDi	94	11/03→07/06		Orga 10528→; für Linkslenker			03.7860-2002.4 300216	ATE Ø 10" pneumatisch
HDi 110	81	11/03→12/09						
 Hauptbremszylinder								
2.0	103	06/04→12/11					03.2122-2163.3 010800	ATE Ø 22,2
HDi	94	11/03→07/06		Orga 10528→			03.2122-2163.3 010800	ATE Ø 22,2
HDi 110	81	11/03→12/09						
CITROËN - C15 Kasten/Großraumlimousine (VD_) 10/84→10/06								
 Bremskraftregler								
1.8 D	44	07/86→12/00					24.6512-1507.3 320023	lastabhängig 3x
1.9 D	44 - 51	01/00→12/05						
CITROËN - C15 Kombi 04/87→08/00								
 Bremskraftregler								
1.8 D	44	04/87→08/00					24.6512-1507.3 320023	lastabhängig 3x

	kw					! #		
CITROËN - C15 Pritsche/Fahrgestell (VDPD) 11/92→10/02								
 Bremskraftregler								
1.8 D 1.9 D	44 51	11/92→05/00 09/00→10/02					24.6512-1507.3 320023	lastabhängig 3x
CITROËN - C-ELYSEE (DD_) 11/12→								
 Hauptbremszylinder								
1.2 PureTech 82 1.2 VTi 82 1.6 BlueHDI 100	61 60 73	02/18→ 12/14→ 11/14→		+ ESP; Schaltgetriebe + ABS / - ESP; Schaltgetriebe			24.4122-1703.3 010843 24.4122-1704.3 010847	TRW Ø 22,2 TRW Ø 22,2
1.2 VTi 72 1.6 VTi 115	53 85	11/12→01/17 11/12→		+ ESP; Orga 13342→; Schaltgetriebe + ABS / - ESP; Schaltgetriebe; Orga 13342→			24.4122-1703.3 010843 24.4122-1704.3 010847	TRW Ø 22,2 TRW Ø 22,2
1.5 BlueHDI 100	75	05/18→		+ ESP; Schaltgetriebe - ESP; Schaltgetriebe			24.4122-1703.3 010843 24.4122-1704.3 010847	TRW Ø 22,2 TRW Ø 22,2
1.6 HDi 92	68	11/12→		+ ESP + ABS / - ESP; Orga 13342→			24.4122-1703.3 010843 24.4122-1704.3 010847	TRW Ø 22,2 TRW Ø 22,2
CITROËN - DS3 (SA_) 11/09→12/16								
 Hauptbremszylinder								
1.4 HDi 70 1.6 HDi 110 1.6 HDi 90 1.6 Racing 1.6 THP 150 1.6 THP 155 1.6 VTi 120	50 82 68 149 - 152 110 115 88	04/10→07/15 11/09→07/15 11/09→07/15 02/11→07/15 01/10→07/15 04/10→07/15 04/10→07/15		12999→ 13341			24.4123-1704.3 010828	TRW Ø 23,8
1.4 VTi 95 1.4 VTi 95 LPG 1.4 VTi 98 1.6 HDi 115	70 70 72 84	04/10→07/15 08/12→07/15 11/09→07/15 08/12→07/15		12999→ 13341 →Orga 13341			24.4122-1703.3 010843 24.4123-1704.3 010828	TRW Ø 22,2 TRW Ø 23,8
CITROËN - DS3 Cabriolet 01/13→07/15								
 Hauptbremszylinder								
1.2 THP 110 1.6 BlueHDI 100 1.6 BlueHDI 115 1.6 BlueHDI 120 1.6 Racing 1.6 THP 165	81 73 - 75 85 88 149 - 152 120 - 121	10/14→07/15 07/14→07/15 10/13→07/15 07/14→07/15 03/14→07/15 10/14→07/15					24.4123-1704.3 010828	TRW Ø 23,8
1.6 HDi 90 1.6 THP 150 1.6 THP 155 1.6 VTi 120	68 110 115 88	01/13→07/15 01/13→07/15 01/13→07/15 01/13→07/15		03/13→			24.4123-1704.3 010828	TRW Ø 23,8
CITROËN - DS5 09/11→12/16								
 Bremskraftverstärker								
1.6 BlueHDI 120 1.6 HDi 1.6 HDi 110 1.6 THP 150 1.6 THP 155 1.6 THP 165 1.6 THP 165 Hybrid 1.6 THP 200 2.0 BlueHDI 150 2.0 BlueHDI 180 2.0 HDi 135 2.0 HDi 165 1.6 HDi 115 2.0 HDi 200 Hybrid4 All-wheel Drive	88 85 82 110 115 121 121 147 110 133 100 120 84 147	07/14→07/15 11/13→07/15 11/11→07/15 11/11→07/15 11/11→07/15 01/12→07/15 06/12→07/15 11/11→07/15 07/14→07/15 08/13→07/15 11/11→07/15 11/11→07/15 06/12→07/15 12/11→07/15		für Fahrzeuge mit Start-Stopp-Funktion 08/12→; für Fahrzeuge mit Start-Stopp-Funktion			03.7860-3734.4 300317 03.7860-3734.4 300317 03.7860-3734.4 300317	ATE Ø 10" pneumatisch ATE Ø 10" pneumatisch ATE Ø 10" pneumatisch
 Hauptbremszylinder								
1.6 BlueHDI 120 1.6 HDi 1.6 HDi 110 1.6 THP 150 1.6 THP 155 1.6 THP 165 1.6 THP 165 Hybrid 1.6 THP 200	88 85 82 110 115 121 121 147	07/14→07/15 11/13→07/15 11/11→07/15 11/11→07/15 11/11→07/15 01/12→07/15 06/12→07/15 11/11→07/15		82 mm Radnabendurchmesser [mm] 83 mm Radnabendurchmesser [mm]			03.4153-0173.3 010815 24.4155-1236.3 011049	ATE Ø 23,8 ATE Ø 25,4 ohne Bremsflüssigkeitsbehälter

	kw					! #		
CITROËN - DS5 09/11→12/16								
 Hauptbremszylinder								
2.0 BlueHDi 150	110	07/14→07/15		82 mm Radnabendurchmesser [mm]		03.4153-0173.3	010815	ATE Ø 23,8
2.0 BlueHDi 180	133	08/13→07/15		83 mm Radnabendurchmesser [mm]		24.4155-1236.3	011049	ATE Ø 25,4 ohne Bremsflüssigkeitsbehälter
2.0 HDi 135	100	11/11→07/15						
2.0 HDi 165	120	11/11→07/15						
2.0 HDi 200 Hybrid4 All-wheel Drive	147	12/11→07/15						
1.6 HDi 115	84	06/12→07/15		08/12→; 82 mm Radnabendurchmesser [mm]		03.4153-0173.3	010815	ATE Ø 23,8
				08/12→; 83 mm Radnabendurchmesser [mm]		24.4155-1236.3	011049	ATE Ø 25,4 ohne Bremsflüssigkeitsbehälter
CITROËN - EVASION Großraumlimousine (22, U6) 03/94→07/02								
 Hauptbremszylinder								
1.8	73	05/97→07/02		→Orga 08206; - ABS		24.2122-1703.3	010422	Ø 22,2
				→Orga 08206; + ABS		24.2122-1708.3	010437	Ø 22,2
				Orga 08207→; - ABS		24.2122-1741.3	010695	Ø 22,2
1.9 TD	66	11/94→07/02		02/95→; →Orga 08206; - ABS		24.2123-1707.3	010492	Ø 23,8
				Orga 08207→; + ABS		24.2123-1733.3	010657	BOS Ø 23,8
				Orga 08207→; - ABS		24.2123-1738.3	010658	Ø 23,8
2.0	89	06/94→07/02		→Orga 08206; - ABS		24.2123-1707.3	010492	Ø 23,8
2.0 16V	100	05/00→07/02		Orga 08207→; + ABS		24.2123-1733.3	010657	BOS Ø 23,8
2.0 Turbo C.T.	108	06/94→07/02		Orga 08207→; - ABS		24.2123-1738.3	010658	Ø 23,8
2.1 TD	80	05/96→07/02		Orga 08207→; - ABS		24.2123-1738.3	010658	Ø 23,8
2.0 16V	97	05/98→04/00		12/98→; →Orga 08206; - ABS		24.2123-1707.3	010492	Ø 23,8
				Orga 08207→; + ABS		24.2123-1733.3	010657	BOS Ø 23,8
				Orga 08207→; - ABS		24.2123-1738.3	010658	Ø 23,8
2.0 HDi	80 - 81	08/99→07/02		+ ABS		24.2123-1733.3	010657	BOS Ø 23,8
2.0 HDi 16V	80	09/99→07/02		- ABS		24.2123-1738.3	010658	Ø 23,8
CITROËN - GRAND C4 SPACETOURER (3A_, 3E_) 04/18→								
 Hauptbremszylinder								
1.2 PureTech 130	96	04/18→				24.4155-1311.3	011053	ATE Ø 25,4 ohne Bremsflüssigkeitsbehälter
1.5 BlueHDi 130	96	05/18→						
1.6 BlueHDi 100	73	04/18→						
1.6 BlueHDi 120	88	04/18→						
1.6 HDi 115	85	04/18→						
1.6 PureTech 180	133	04/18→						
1.6 THP 165	110 - 121	04/18→						
2.0 BlueHDi 150	110	04/18→						
2.0 BlueHDi 160	120	04/18→						
CITROËN - GRAND C4 SPACETOURER Van (3A_, 3E_) 04/18→								
 Hauptbremszylinder								
BlueHDi 130	96	05/19→				24.4155-1311.3	011053	ATE Ø 25,4 ohne Bremsflüssigkeitsbehälter
BlueHDi 160	120	05/19→						
PureTech 130	96	05/19→						
CITROËN - JUMPER I Bus (230P) 02/94→04/02								
 Hauptbremszylinder								
1.9 D	51	01/99→04/02		→ S 15064995; Nutzlast [kg]: 1.000; für Linkslenker; - ABS		24.2122-1715.3	010481	Ø 22,2
				S 15064996→ S 16206233; Nutzlast [kg]: 1.000; + ABS		24.2125-1702.3	010482	Ø 25,4
				S 15064996→ S 16205754; Nutzlast [kg]: 1.000; für Linkslenker; - ABS		24.2125-1703.3	010483	Ø 25,4
				S 16206234→; → 03/02; Nutzlast [kg]: 1.000; + ABS		24.2125-1726.3	010718	Ø 25,4
1.9 TD	66 - 68	02/94→04/02		→ S 15064995; Nutzlast ab [kg] 1.000 Nutzlast bis [kg] 1.400; für Linkslenker; - ABS		24.2122-1715.3	010481	Ø 22,2
1.9 TD 4x4	68	08/96→04/02		S 15064996→ S 16206233; Nutzlast ab [kg] 1.000 Nutzlast bis [kg] 1.400; + ABS		24.2125-1702.3	010482	Ø 25,4
				S 15064996→ S 16205754; Nutzlast ab [kg] 1.000 Nutzlast bis [kg] 1.400; für Linkslenker; - ABS		24.2125-1703.3	010483	Ø 25,4
				S 16206234→; → 03/02; Nutzlast ab [kg] 1.000 Nutzlast bis [kg] 1.400; + ABS		24.2125-1726.3	010718	Ø 25,4
2.0	80	02/94→04/02		→ S 15064995; Nutzlast [kg]: 1.000; für Linkslenker; - ABS		24.2122-1715.3	010481	Ø 22,2
→								

	kw			 	! #		
CITROËN - JUMPER I Bus (230P) 02/94→04/02							
 Hauptbremszylinder							
2.0	80	02/94→04/02	S 15064996→ S 16206233; Nutzlast ab [kg] 1.000 Nutzlast bis [kg] 1.400; + ABS	24.2125-1702.3	010482	Ø 25,4	
			→ S 16194399; Nutzlast [kg]: 1.800; + ABS	24.2125-1702.3	010482	Ø 25,4	
			S 15064996→ S 16205754; Nutzlast ab [kg] 1.000 Nutzlast bis [kg] 1.400; für Linkslenker; - ABS	24.2125-1703.3	010483	Ø 25,4	
			→ S 16205754; Nutzlast [kg]: 1.800; für Linkslenker; - ABS	24.2125-1703.3	010483	Ø 25,4	
			S 16194400→; → 03/02; Nutzlast [kg]: 1.800; + ABS	24.2125-1726.3	010718	Ø 25,4	
			S 16206234→; → 03/02; Nutzlast ab [kg] 1.000 Nutzlast bis [kg] 1.400; + ABS	24.2125-1726.3	010718	Ø 25,4	
2.0 4x4	80	08/96→04/02	S 15064996→ S 16206233; Nutzlast ab [kg] 1.000 Nutzlast bis [kg] 1.400; + ABS	24.2125-1702.3	010482	Ø 25,4	
			S 15064996→ S 16205754; Nutzlast ab [kg] 1.000 Nutzlast bis [kg] 1.400; für Linkslenker; - ABS	24.2125-1703.3	010483	Ø 25,4	
			S 16206234→; → 03/02; Nutzlast ab [kg] 1.000 Nutzlast bis [kg] 1.400; + ABS	24.2125-1726.3	010718	Ø 25,4	
2.5 D 2.5 TD	63 76	08/94→04/02 08/94→04/02	→ S 15064995; Nutzlast [kg]: 1.400; für Linkslenker; - ABS	24.2122-1715.3	010481	Ø 22,2	
			→ S 16194399; Nutzlast [kg]: 1.800; + ABS	24.2125-1702.3	010482	Ø 25,4	
	S 15064996→ S 16206233; Nutzlast [kg]: 1.400; + ABS	24.2125-1702.3	010482	Ø 25,4			
	→ S 16205754; Nutzlast [kg]: 1.800; für Linkslenker; - ABS	24.2125-1703.3	010483	Ø 25,4			
	S 15064996→ S 16205754; Nutzlast [kg]: 1.400; für Linkslenker; - ABS	24.2125-1703.3	010483	Ø 25,4			
	S 16206234→; → 03/02; Nutzlast [kg]: 1.400; + ABS	24.2125-1726.3	010718	Ø 25,4			
	S 16194400→; → 03/02; Nutzlast [kg]: 1.800; + ABS	24.2125-1726.3	010718	Ø 25,4			
	→ S 16194399; Nutzlast [kg]: 1.800; + ABS	24.2125-1702.3	010482	Ø 25,4			
2.5 TDi	79	12/96→11/00	S 15064996→ S 16206233; Nutzlast [kg]: 1.400; + ABS	24.2125-1702.3	010482	Ø 25,4	
			→ S 16205754; Nutzlast ab [kg] 1.400 Nutzlast bis [kg] 1.800; für Linkslenker; - ABS	24.2125-1703.3	010483	Ø 25,4	
			S 16206234→; Nutzlast [kg]: 1.400; + ABS	24.2125-1726.3	010718	Ø 25,4	
			S 16194400→; Nutzlast [kg]: 1.800; + ABS	24.2125-1726.3	010718	Ø 25,4	
			→ S 16205754; Nutzlast ab [kg] 1.400 Nutzlast bis [kg] 1.800; für Linkslenker; - ABS	24.2125-1703.3	010483	Ø 25,4	
2.5 TDi 4x4 2.8 HDi 4x4	79 94	12/96→11/00 09/00→04/02	→ S 16205754; Nutzlast ab [kg] 1.400 Nutzlast bis [kg] 1.800; für Linkslenker; - ABS	24.2125-1703.3	010483	Ø 25,4	
			→ S 16205754; Nutzlast ab [kg] 1.400 Nutzlast bis [kg] 1.800; für Linkslenker; - ABS	24.2125-1703.3	010483	Ø 25,4	
2.8 D	64	01/99→02/02	→ S 15064995; Nutzlast [kg]: 1.400; für Linkslenker; - ABS	24.2122-1715.3	010481	Ø 22,2	
			→ S 16194399; Nutzlast [kg]: 1.800	24.2125-1702.3	010482	Ø 25,4	
			S 15064996→ S 16206253; Nutzlast [kg]: 1.400; + ABS	24.2125-1702.3	010482	Ø 25,4	
			S 15064996→ S 16205754; Nutzlast [kg]: 1.400; für Linkslenker; - ABS	24.2125-1703.3	010483	Ø 25,4	
			→ S 16205352; Nutzlast [kg]: 1.800; für Linkslenker; - ABS	24.2125-1703.3	010483	Ø 25,4	
			S 16194400→; Nutzlast [kg]: 1.800; + ABS	24.2125-1726.3	010718	Ø 25,4	
			S 16206254→; Nutzlast [kg]: 1.400; + ABS	24.2125-1726.3	010718	Ø 25,4	
2.8 HDi	94	09/00→04/02	→ S 16206233; Nutzlast [kg]: 1.400; + ABS	24.2125-1702.3	010482	Ø 25,4	
			→ S 16194399; Nutzlast [kg]: 1.800; + ABS	24.2125-1702.3	010482	Ø 25,4	
			→ S 16205754; Nutzlast ab [kg] 1.400 Nutzlast bis [kg] 1.800; für Linkslenker; - ABS	24.2125-1703.3	010483	Ø 25,4	
			S 16206234→; → 03/02; Nutzlast [kg]: 1.400; + ABS	24.2125-1726.3	010718	Ø 25,4	
			S 16194400→; → 03/02; Nutzlast [kg]: 1.800; + ABS	24.2125-1726.3	010718	Ø 25,4	
			→ S 16205754; Nutzlast ab [kg] 1.400 Nutzlast bis [kg] 1.800; für Linkslenker; - ABS	24.2125-1703.3	010483	Ø 25,4	
→							

CITROËN - JUMPER I Bus (230P) 02/94→04/02

Bremskraftregler

1.9 D	51	01/99→04/02	→ S 16206244; Nutzlast [kg]: 1.000; - ABS	24.6512-1701.3	320153	lastabhängig 2x
1.9 TD	66 - 68	02/94→04/02	→ S 16206244; Nutzlast ab [kg] 1.000 Nutzlast bis [kg] 1.400; - ABS	24.6512-1701.3	320153	lastabhängig 2x
1.9 TD 4x4	68	08/96→04/02				
2.0	80	02/94→04/02	→ S 16206244; Nutzlast ab [kg] 1.000 Nutzlast bis [kg] 1.800; - ABS	24.6512-1701.3	320153	lastabhängig 2x
2.0 4x4	80	08/96→04/02				
2.5 D	63	08/94→04/02	→ S 16206244; Nutzlast ab [kg] 1.400 Nutzlast bis [kg] 1.800; - ABS	24.6512-1701.3	320153	lastabhängig 2x
2.5 D 4x4	63	08/96→04/02				
2.5 TD	76	08/94→04/02				
2.5 TD 4x4	76	08/96→04/02				
2.8 D	64	01/99→02/02				
2.8 HDi	94	09/00→04/02				
2.8 HDi 4x4	94	09/00→04/02				
2.5 TDi	79	12/96→11/00				
2.5 TDi 4x4	79	12/96→11/00				

CITROËN - JUMPER I Bus (244, Z_) 04/02→

Hauptbremszylinder

2.0	81	04/02→06/06	→ 03/06; Nutzlast ab [kg] 1.000 Nutzlast bis [kg] 1.800; + ABS	24.2125-1726.3	010718	Ø 25,4
2.0 HDi	62	04/02→06/06				
2.2 HDi	74	04/02→06/06				
2.8 HDi	94	04/02→06/06				
2.0 bivalent	81	02/03→06/06	→ S 15064995; Nutzlast [kg]: 1.000; für Linkslenker; - ABS	24.2122-1715.3	010481	Ø 22,2
2.8 HDi All-wheel Drive	94	04/02→06/06	→ 03/06; + ABS	24.2125-1726.3	010718	Ø 25,4

Bremskraftregler

2.8 HDi All-wheel Drive	94	04/02→06/06	→ 03/06; Nutzlast ab [kg] 1.000 Nutzlast bis [kg] 1.800; - ABS	24.6512-1701.3	320153	lastabhängig 2x
-------------------------	----	-------------	--	----------------	--------	-----------------

CITROËN - JUMPER I Kasten (230L) 02/94→08/02

Hauptbremszylinder

1.9 D	50 - 51	02/94→04/02	→ S 15064995; Nutzlast [kg]: 1.000; für Linkslenker; - ABS	24.2122-1715.3	010481	Ø 22,2
			S 15064996→ S 16206233; Nutzlast [kg]: 1.000; + ABS	24.2125-1702.3	010482	Ø 25,4
			S 15064996→ S 16205754; Nutzlast [kg]: 1.000; für Linkslenker; - ABS	24.2125-1703.3	010483	Ø 25,4
			S 16206234→; → 03/02; Nutzlast [kg]: 1.000; + ABS	24.2125-1726.3	010718	Ø 25,4
1.9 TD	66 - 68	03/94→04/02	→ S 15064995; Nutzlast ab [kg] 1.000 Nutzlast bis [kg] 1.400; für Linkslenker; - ABS	24.2122-1715.3	010481	Ø 22,2
			S 15064996→ S 16206233; Nutzlast ab [kg] 1.000 Nutzlast bis [kg] 1.400; + ABS	24.2125-1702.3	010482	Ø 25,4
			S 15064996→ S 16205754; Nutzlast ab [kg] 1.000 Nutzlast bis [kg] 1.400; für Linkslenker; - ABS	24.2125-1703.3	010483	Ø 25,4
			S 16206234→; → 03/02; Nutzlast ab [kg] 1.000 Nutzlast bis [kg] 1.400; + ABS	24.2125-1726.3	010718	Ø 25,4
2.0	80	03/94→04/02	→ S 15064995; Nutzlast ab [kg] 1.000 Nutzlast bis [kg] 1.400; für Linkslenker; - ABS	24.2122-1715.3	010481	Ø 22,2
			S 15064996→ S 16206233; Nutzlast ab [kg] 1.000 Nutzlast bis [kg] 1.400; + ABS	24.2125-1702.3	010482	Ø 25,4
			→ S 16194399; Nutzlast [kg]: 1.800; + ABS	24.2125-1702.3	010482	Ø 25,4
			→ S 16205754; Nutzlast [kg]: 1.800; für Linkslenker; - ABS	24.2125-1703.3	010483	Ø 25,4
			S 15064996→ S 16205754; Nutzlast ab [kg] 1.000 Nutzlast bis [kg] 1.400; für Linkslenker; - ABS	24.2125-1703.3	010483	Ø 25,4
			S 16206234→; → 03/02; Nutzlast ab [kg] 1.000 Nutzlast bis [kg] 1.400; + ABS	24.2125-1726.3	010718	Ø 25,4
			S 16194400→; → 03/02; Nutzlast [kg]: 1.800; + ABS	24.2125-1726.3	010718	Ø 25,4
2.0 4x4	80	10/96→01/02	→ S 15064995; Nutzlast ab [kg] 1.000 Nutzlast bis [kg] 1.400; für Linkslenker; - ABS	24.2122-1715.3	010481	Ø 22,2
			S 15064996→ S 16206233; Nutzlast ab [kg] 1.000 Nutzlast bis [kg] 1.400; + ABS	24.2125-1702.3	010482	Ø 25,4
			→ S 16194399; Nutzlast [kg]: 1.800; + ABS	24.2125-1702.3	010482	Ø 25,4

→

CITROËN - JUMPER I Kasten (230L) 02/94→08/02

Hauptbremszylinder

2.0 4x4	80	10/96→01/02	→ S 16205754; Nutzlast [kg]: 1.800; für Linkslenker; - ABS	24.2125-1703.3	010483	Ø 25,4
			S 15064996→ S 16205754; Nutzlast ab [kg] 1.000 Nutzlast bis [kg] 1.400; für Linkslenker; - ABS			
			S 16206234→; Nutzlast ab [kg] 1.000 Nutzlast bis [kg] 1.400; + ABS			
			S 16194400→; Nutzlast [kg]: 1.800; + ABS			
2.0 HDI	62	11/01→04/02	→ 03/02; Nutzlast ab [kg] 1.000 Nutzlast bis [kg] 1.800; + ABS	24.2125-1726.3	010718	Ø 25,4
2.5 D 2.5 D 4x4 2.5 TD	63 63 76	03/94→04/02 03/00→04/02 03/94→04/02	→ S 15064995; Nutzlast [kg]: 1.400; für Linkslenker; - ABS	24.2122-1715.3	010481	Ø 22,2
			→ S 16194399; Nutzlast [kg]: 1.800; + ABS			
			S 15064996→ S 16206233; Nutzlast [kg]: 1.400; + ABS			
			→ S 16205754; Nutzlast [kg]: 1.800; für Linkslenker; - ABS			
			S 15064996→ S 16205754; Nutzlast [kg]: 1.400; für Linkslenker; - ABS			
			S 16206234→; → 03/02; Nutzlast [kg]: 1.400; + ABS			
2.5 TDi 2.5 TDi 4x4	79 79	12/96→11/00 03/00→11/00	→ S 16194399; Nutzlast [kg]: 1.800; + ABS	24.2125-1702.3	010482	Ø 25,4
			S 15064996→ S 16206233; Nutzlast [kg]: 1.400; + ABS			
			→ S 16205754; Nutzlast ab [kg] 1.400 Nutzlast bis [kg] 1.800; für Linkslenker; - ABS			
			S 16206234→; Nutzlast [kg]: 1.400; + ABS			
			S 16194400→; Nutzlast [kg]: 1.800; + ABS			
2.8 HDi 2.8 HDi 4x4	94 94	09/00→04/02 09/00→04/02	→ S 16194399; Nutzlast [kg]: 1.800; + ABS	24.2125-1702.3	010482	Ø 25,4
			S 15064996→ S 16206233; Nutzlast [kg]: 1.400; + ABS			
			→ S 16205754; Nutzlast ab [kg] 1.400 Nutzlast bis [kg] 1.800; für Linkslenker; - ABS			
			S 16206234→; → 03/02; Nutzlast [kg]: 1.400; + ABS			
			S 16194400→; → 03/02; Nutzlast [kg]: 1.800; + ABS			

Bremskraftregler

1.9 D	50 - 51	02/94→04/02	→ S 16206244; Nutzlast [kg]: 1.000; - ABS	24.6512-1701.3	320153	lastabhängig 2x
1.9 TD	66 - 68	03/94→04/02	→ S 16206244; Nutzlast ab [kg] 1.000 Nutzlast bis [kg] 1.400; - ABS			
2.0 2.0 4x4	80 80	03/94→04/02 10/96→01/02	→ S 16206244; Nutzlast ab [kg] 1.000 Nutzlast bis [kg] 1.800; - ABS	24.6512-1701.3	320153	lastabhängig 2x
2.5 D 2.5 D 4x4 2.5 TD 2.5 TDi 2.5 TDi 4x4	63 63 76 79 79	03/94→04/02 03/00→04/02 03/94→04/02 12/96→11/00 03/00→11/00	→ S 16206244; Nutzlast ab [kg] 1.400 Nutzlast bis [kg] 1.800; - ABS			
2.8 HDi 2.8 HDi 4x4	94 94	09/00→04/02 09/00→04/02	→ S 16206244; Nutzlast ab [kg] 1.400 Nutzlast bis [kg] 1.800; - ABS	24.6512-1701.3	320153	lastabhängig 2x
			→ S 16206244; Nutzlast ab [kg] 1.400 Nutzlast bis [kg] 1.800; - ABS			









CITROËN - JUMPER I Kasten (244) 04/02→













Hauptbremszylinder

2.0 2.0 bivalent 2.0 HDi 2.2 HDi 2.8 HDi	81	04/02→06/06	→ 03/06; Nutzlast ab [kg] 1.000 Nutzlast bis [kg] 1.800; + ABS	24.2125-1726.3	010718	Ø 25,4
	81	02/03→06/06				
	62	04/02→06/06				
	74	04/02→06/06				
	94 - 107	04/02→06/06				
2.8 HDi 4x4	94	04/02→06/06	→ 03/06; + ABS	24.2125-1726.3	010718	Ø 25,4













Bremskraftregler











2.8 HDi 4x4	94	04/02→06/06	→ 03/06; Nutzlast ab [kg] 1.000 Nutzlast bis [kg] 1.800; - ABS	24.6512-1701.3	320153	lastabhängig 2x
-------------	----	-------------	--	----------------	--------	-----------------

	kw					! #		
CITROËN - JUMPER I Pritsche/Fahrgestell (230) 03/94→04/02								
 Hauptbremszylinder								
1.9 TD	66 - 68	03/94→04/02		→ S 15064995; Nutzlast ab [kg] 1.000 Nutzlast bis [kg] 1.400; - ABS; für Linkslenker	24.2122-1715.3	010481	Ø 22,2	
				S 15064996→ S 16206233; Nutzlast ab [kg] 1.000 Nutzlast bis [kg] 1.400; + ABS	24.2125-1702.3	010482	Ø 25,4	
				S 15064996→ S 16205754; Nutzlast ab [kg] 1.000 Nutzlast bis [kg] 1.400; - ABS; für Linkslenker	24.2125-1703.3	010483	Ø 25,4	
				S 16206234→; → 03/02; Nutzlast ab [kg] 1.000 Nutzlast bis [kg] 1.400; + ABS	24.2125-1726.3	010718	Ø 25,4	
2.0	80	03/94→04/02		→ S 15064995; Nutzlast ab [kg] 1.000 Nutzlast bis [kg] 1.400; - ABS; für Linkslenker	24.2122-1715.3	010481	Ø 22,2	
				S 15064996→ S 16206233; Nutzlast ab [kg] 1.000 Nutzlast bis [kg] 1.400; + ABS	24.2125-1702.3	010482	Ø 25,4	
				→ S 16194399; Nutzlast [kg]: 1.800; + ABS	24.2125-1702.3	010482	Ø 25,4	
				→ S 16205754; Nutzlast [kg]: 1.800; - ABS; für Linkslenker	24.2125-1703.3	010483	Ø 25,4	
				S 15064996→ S 16205754; Nutzlast ab [kg] 1.000 Nutzlast bis [kg] 1.400; - ABS; für Linkslenker	24.2125-1703.3	010483	Ø 25,4	
				S 16206234→; → 03/02; Nutzlast ab [kg] 1.000 Nutzlast bis [kg] 1.400; + ABS	24.2125-1726.3	010718	Ø 25,4	
				S 16194400→; → 03/02; Nutzlast [kg]: 1.800; + ABS	24.2125-1726.3	010718	Ø 25,4	
2.5 D 2.5 D 4x4 2.5 TD	63 63 76	03/94→04/02 03/00→04/02 03/94→04/02		→ S 15064995; Nutzlast [kg]: 1.400; - ABS; für Linkslenker	24.2122-1715.3	010481	Ø 22,2	
				→ S 16194399; Nutzlast [kg]: 1.800; + ABS	24.2125-1702.3	010482	Ø 25,4	
				S 15064996→ S 16206233; Nutzlast [kg]: 1.400; + ABS	24.2125-1702.3	010482	Ø 25,4	
				→ S 16205754; Nutzlast [kg]: 1.800; - ABS; für Linkslenker	24.2125-1703.3	010483	Ø 25,4	
				S 15064996→ S 16205754; Nutzlast [kg]: 1.400; - ABS; für Linkslenker	24.2125-1703.3	010483	Ø 25,4	
				S 16194400→; → 03/02; Nutzlast [kg]: 1.800; + ABS	24.2125-1726.3	010718	Ø 25,4	
				S 16206234→; → 03/02; Nutzlast [kg]: 1.400; + ABS	24.2125-1726.3	010718	Ø 25,4	
2.5 TDi 2.5 TDi 4x4 2.8 HDi	79 79 94	12/96→04/02 03/00→04/02 09/00→04/02		→ S 16206233; Nutzlast [kg]: 1.400; + ABS	24.2125-1702.3	010482	Ø 25,4	
				→ S 16194399; Nutzlast [kg]: 1.800; + ABS	24.2125-1702.3	010482	Ø 25,4	
				→ S 16205754; Nutzlast ab [kg] 1.400 Nutzlast bis [kg] 1.800; - ABS; für Linkslenker	24.2125-1703.3	010483	Ø 25,4	
				S 16194400→; → 03/02; Nutzlast [kg]: 1.800; + ABS	24.2125-1726.3	010718	Ø 25,4	
				S 16206234→; → 03/02; Nutzlast [kg]: 1.400; + ABS	24.2125-1726.3	010718	Ø 25,4	
				→ S 15064995; Nutzlast [kg]: 1.400; - ABS; für Linkslenker	24.2122-1715.3	010481	Ø 22,2	
2.8 D	64	01/99→02/02		→ S 16194399; Nutzlast [kg]: 1.800; + ABS	24.2125-1702.3	010482	Ø 25,4	
				S 15064996→ S 16206253; Nutzlast [kg]: 1.400; + ABS	24.2125-1702.3	010482	Ø 25,4	
				→ S 16205352; Nutzlast [kg]: 1.800; für Linkslenker; - ABS	24.2125-1703.3	010483	Ø 25,4	
				S 15064996→ S 16205754; Nutzlast [kg]: 1.400; - ABS; für Linkslenker	24.2125-1703.3	010483	Ø 25,4	
				S 16194400→; Nutzlast [kg]: 1.800; + ABS	24.2125-1726.3	010718	Ø 25,4	
				S 16206254→; Nutzlast [kg]: 1.400; + ABS	24.2125-1726.3	010718	Ø 25,4	
				→ S 15064995; Nutzlast [kg]: 1.400; - ABS; für Linkslenker	24.2122-1715.3	010481	Ø 22,2	
 Bremskraftregler								
1.9 TD	66 - 68	03/94→04/02		→ S 16206244; Nutzlast ab [kg] 1.000 Nutzlast bis [kg] 1.400; - ABS	24.6512-1701.3	320153	lastabhängig 2x	
2.0	80	03/94→04/02		→ S 16206244; Nutzlast ab [kg] 1.000 Nutzlast bis [kg] 1.800; - ABS	24.6512-1701.3	320153	lastabhängig 2x	
2.5 D 2.5 D 4x4 2.5 TD 2.5 TDi 2.5 TDi 4x4 →	63 63 76 79 79	03/94→04/02 03/00→04/02 03/94→04/02 12/96→04/02 03/00→04/02		→ S 16206244; Nutzlast ab [kg] 1.400 Nutzlast bis [kg] 1.800; - ABS	24.6512-1701.3	320153	lastabhängig 2x	

	kw					! #		
CITROËN - JUMPER I Pritsche/Fahrgestell (230) 03/94→04/02								
 Bremskraftregler								
2.8 D 2.8 HDi	64 94	01/99→02/02 09/00→04/02		→ S 16206244; Nutzlast ab [kg] 1.400 Nutzlast bis [kg] 1.800; - ABS		24.6512-1701.3 320153		lastabhängig 2x
CITROËN - JUMPER I Pritsche/Fahrgestell (244) 02/02→								
 Hauptbremszylinder								
2.0 HDi 2.2 HDi 2.8 HDi	62 74 94 - 107	04/02→06/06 04/02→06/06 04/02→06/06		→ 03/06; Nutzlast ab [kg] 1.000 Nutzlast bis [kg] 1.800; + ABS		24.2125-1726.3 010718		Ø 25,4
2.8 HDi 4x4	94	02/02→06/06		04/02→ 03/06; + ABS		24.2125-1726.3 010718		Ø 25,4
 Bremskraftregler								
2.8 HDi 4x4	94	02/02→06/06		04/02→ 03/06; Nutzlast ab [kg] 1.000 Nutzlast bis [kg] 1.800; - ABS		24.6512-1701.3 320153		lastabhängig 2x
CITROËN - JUMPER II Bus 04/06→								
 Hauptbremszylinder								
2.2 HDi 100 2.2 HDi 110 2.2 HDi 120 2.2 HDi 130 2.2 HDi 150 3.0 HDi 155 3.0 HDi 160 3.0 HDi 180	74 81 88 96 110 115 116 130	04/06→ 07/11→ 04/06→ 07/11→ 07/11→ 07/10→ 09/06→ 07/11→		Nutzlast ab [kg] 1.200 Nutzlast bis [kg] 1.400; + DSC; nicht für Facelift; Nutzlast- Code: 12Q / 14Q		24.4125-1701.3 010867		BOS Ø 25,4 ohne Bremsflüssig- keitsbehälter
				Nutzlast ab [kg] 1.200 Nutzlast bis [kg] 1.400; - DSC; nicht für Facelift; Nutzlast- Code: 12Q / 14Q		24.4125-1702.3 010872		BOS Ø 25,4 ohne Bremsflüssig- keitsbehälter
				Nutzlast ab [kg] 1.600 Nutzlast bis [kg] 2.000; + DSC; nicht für Facelift; Nutzlast- Code: 16Q / 20Q		24.4126-1701.3 010868		BOS Ø 27 ohne Bremsflüssig- keitsbehälter
				Nutzlast ab [kg] 1.600 Nutzlast bis [kg] 2.000; - DSC; nicht für Facelift; Nutzlast- Code: 16Q / 20Q		24.4126-1702.3 010875		BOS Ø 27 ohne Bremsflüssig- keitsbehälter
CITROËN - JUMPER II Kasten 04/06→								
 Hauptbremszylinder								
2.2 HDi 100 2.2 HDi 110 2.2 HDi 120 2.2 HDi 130 2.2 HDi 130 4x4 2.2 HDi 150 3.0 HDi 145 3.0 HDi 155 3.0 HDi 160 3.0 HDi 180	74 81 88 96 96 110 107 115 116 130	04/06→12/12 07/11→ 04/06→ 07/11→ 01/12→05/16 07/11→ 07/10→12/13 07/10→12/15 09/06→12/15 07/11→		Nutzlast ab [kg] 1.200 Nutzlast bis [kg] 1.400; + DSC; nicht für Facelift; Nutzlast- Code: 12Q / 14Q		24.4125-1701.3 010867		BOS Ø 25,4 ohne Bremsflüssig- keitsbehälter
				Nutzlast ab [kg] 1.200 Nutzlast bis [kg] 1.400; - DSC; nicht für Facelift; Nutzlast- Code: 12Q / 14Q		24.4125-1702.3 010872		BOS Ø 25,4 ohne Bremsflüssig- keitsbehälter
				Nutzlast ab [kg] 1.600 Nutzlast bis [kg] 2.000; + DSC; nicht für Facelift; Nutzlast- Code: 16Q / 20Q		24.4126-1701.3 010868		BOS Ø 27 ohne Bremsflüssig- keitsbehälter
				Nutzlast ab [kg] 1.600 Nutzlast bis [kg] 2.000; - DSC; nicht für Facelift; Nutzlast- Code: 16Q / 20Q		24.4126-1702.3 010875		BOS Ø 27 ohne Bremsflüssig- keitsbehälter
CITROËN - JUMPER II Pritsche/Fahrgestell 04/06→								
 Hauptbremszylinder								
2.2 HDi 100 2.2 HDi 110 2.2 HDi 120 2.2 HDi 130 2.2 HDi 150 3.0 HDi 145 3.0 HDi 160 3.0 HDi 180	74 81 88 96 110 107 116 130	04/06→ 07/11→ 04/06→ 07/11→ 07/11→ 07/10→12/13 09/06→12/15 07/11→		Nutzlast ab [kg] 1.200 Nutzlast bis [kg] 1.400; + DSC; nicht für Facelift; Nutzlast- Code: 12Q / 14Q		24.4125-1701.3 010867		BOS Ø 25,4 ohne Bremsflüssig- keitsbehälter
				Nutzlast ab [kg] 1.200 Nutzlast bis [kg] 1.400; - DSC; nicht für Facelift; Nutzlast- Code: 12Q / 14Q		24.4125-1702.3 010872		BOS Ø 25,4 ohne Bremsflüssig- keitsbehälter
				Nutzlast ab [kg] 1.600 Nutzlast bis [kg] 2.000; + DSC; nicht für Facelift; Nutzlast- Code: 16Q / 20Q		24.4126-1701.3 010868		BOS Ø 27 ohne Bremsflüssig- keitsbehälter
				Nutzlast ab [kg] 1.600 Nutzlast bis [kg] 2.000; - DSC; nicht für Facelift; Nutzlast- Code: 16Q / 20Q		24.4126-1702.3 010875		BOS Ø 27 ohne Bremsflüssig- keitsbehälter
CITROËN - JUMPY I (U6U_) 06/94→12/06								
 Hauptbremszylinder								
1.6 1.9 D 70 1.9 TD	58 51 66 - 68	10/95→08/00 04/98→11/03 10/95→11/03		→Orga 08206; - ABS; Nutzlast [kg]: 800		24.2122-1703.3 010422		Ø 22,2
				→Orga 08206; + ABS; Nutzlast [kg]: 800		24.2122-1708.3 010437		Ø 22,2
				Orga 08207→; - ABS; Nutzlast [kg]: 800		24.2122-1741.3 010695		Ø 22,2
				→Orga 08206; - ABS; Nutzlast [kg]: 900		24.2123-1707.3 010492		Ø 23,8
				Orga 08207→; + ABS; Nutzlast [kg]: 900		24.2123-1733.3 010657		BOS Ø 23,8
				Orga 08207→; - ABS; Nutzlast [kg]: 900		24.2123-1738.3 010658		Ø 23,8
2.0 2.0 HDi 110 2.0 HDi 95 2.0 i 16V	100 80 69 102	04/00→12/06 03/00→10/06 10/99→10/06 03/00→10/06		+ ABS		24.2123-1733.3 010657		BOS Ø 23,8
				- ABS		24.2123-1738.3 010658		Ø 23,8



	kw					! #		
CITROËN - JUMPY I Kasten (BS_, BT_, BY_, BZ_) 06/94→10/06								
 Hauptbremszylinder								
1.6 i	58	10/95→08/00		→Orga 08206; - ABS; Nutzlast [kg]: 800		24.2122-1703.3 010422	Ø 22,2	
1.9 D 70	51	04/98→10/06		→Orga 08206; + ABS; Nutzlast [kg]: 800		24.2122-1708.3 010437	Ø 22,2	
1.9 DT	65	10/95→08/00		Orga 08207→; - ABS; Nutzlast [kg]: 800		24.2122-1741.3 010695	Ø 22,2	
1.9 TD	66	10/95→08/00		→Orga 08206; - ABS; Nutzlast [kg]: 900		24.2123-1707.3 010492	Ø 23,8	
				Orga 08207→; + ABS; Nutzlast [kg]: 900		24.2123-1733.3 010657	BOS Ø 23,8	
				Orga 08207→; - ABS; Nutzlast [kg]: 900		24.2123-1738.3 010658	Ø 23,8	
2.0	100	04/00→10/06		+ ABS		24.2123-1733.3 010657	BOS Ø 23,8	
2.0 HDi 110	80	01/02→10/06		- ABS		24.2123-1738.3 010658	Ø 23,8	
2.0 HDi 95	69	10/99→10/06						
2.0 i 16V	102	03/00→10/06						
2.0 HDi 110	80	10/01→10/06		01/02→; + ABS		24.2123-1733.3 010657	BOS Ø 23,8	
				01/02→; - ABS		24.2123-1738.3 010658	Ø 23,8	
CITROËN - JUMPY I Pritsche/Fahrgestell (BU_, BV_, BW_, BX_) 10/99→10/06								
 Hauptbremszylinder								
1.9 TD	51	11/00→10/06		→Orga 08206; - ABS; Nutzlast [kg]: 800		24.2122-1703.3 010422	Ø 22,2	
				→Orga 08206; + ABS; Nutzlast [kg]: 800		24.2122-1708.3 010437	Ø 22,2	
				Orga 08207→; - ABS; Nutzlast [kg]: 800		24.2122-1741.3 010695	Ø 22,2	
				→Orga 08206; - ABS; Nutzlast [kg]: 900		24.2123-1707.3 010492	Ø 23,8	
				Orga 08207→; + ABS; Nutzlast [kg]: 900		24.2123-1733.3 010657	BOS Ø 23,8	
				Orga 08207→; - ABS; Nutzlast [kg]: 900		24.2123-1738.3 010658	Ø 23,8	
1.9 TD	68	10/99→10/06		- ABS; Nutzlast [kg]: 800		24.2122-1741.3 010695	Ø 22,2	
				+ ABS; Nutzlast [kg]: 900		24.2123-1733.3 010657	BOS Ø 23,8	
				- ABS; Nutzlast [kg]: 900		24.2123-1738.3 010658	Ø 23,8	
2.0	100	12/03→10/06		+ ABS		24.2123-1733.3 010657	BOS Ø 23,8	
2.0 HDi 110	80	12/03→10/06		- ABS		24.2123-1738.3 010658	Ø 23,8	
2.0 HDi 110 16V	80	12/03→10/06						
2.0 HDi 95	69	10/99→10/06						
CITROËN - JUMPY II (VF7) 01/07→03/16								
 Hauptbremszylinder								
1.6 HDi 90 16V	66	01/07→03/16		für Linkslenker; + ESP		03.2125-0671.3 010965	ATE Ø 25,4	
1.6 HDi 90 8V	66	01/07→03/16		für Linkslenker; - ESP		03.2125-0676.3 011009	ATE Ø 25,4 ohne Bremsflüssigkeitsbehälter	
2.0 HDi 120	88	01/07→03/16						
2.0 HDi 125	94	07/11→03/16						
2.0 HDi 140	100	01/07→03/16		für Rechtslenker; - ESP		24.2123-3396.3 011035	ATE Ø 23,8 ohne Bremsflüssigkeitsbehälter	
2.0 HDi 165	120	07/10→03/16						
2.0 HDi 95	72	07/11→03/16						
2.0 i	103	01/07→03/16						
CITROËN - JUMPY II Kasten 01/07→03/16								
 Hauptbremszylinder								
1.6 HDi 90 16V	66	01/07→03/16		für Linkslenker; + ESP		03.2125-0671.3 010965	ATE Ø 25,4	
1.6 HDi 90 8V	66	01/07→03/16		für Linkslenker; - ESP		03.2125-0676.3 011009	ATE Ø 25,4 ohne Bremsflüssigkeitsbehälter	
2.0 HDi 120	88	01/07→03/16						
2.0 HDi 120 4x4	88	01/10→03/16						
2.0 HDi 125	94	07/11→03/16		für Rechtslenker; - ESP		24.2123-3396.3 011035	ATE Ø 23,8 ohne Bremsflüssigkeitsbehälter	
2.0 HDi 125 4x4	94	07/11→03/16						
2.0 HDi 140	100	01/07→03/16						
2.0 HDi 165	120	07/10→03/16						
2.0 HDi 95	72	07/11→03/16						
2.0 i	103	01/07→03/16						
CITROËN - JUMPY II Pritsche/Fahrgestell 11/06→								
 Hauptbremszylinder								
1.6 HDi 90 16V	66	06/07→03/16		für Linkslenker; + ESP		03.2125-0671.3 010965	ATE Ø 25,4	
1.6 HDi 90 8V	66	06/07→03/16		für Linkslenker; - ESP		03.2125-0676.3 011009	ATE Ø 25,4 ohne Bremsflüssigkeitsbehälter	
2.0 HDi	88	01/09→03/16						
	120							
2.0 HDi 100	72	07/11→03/16		für Rechtslenker; - ESP		24.2123-3396.3 011035	ATE Ø 23,8 ohne Bremsflüssigkeitsbehälter	
2.0 HDi 125	94	07/11→						
2.0 I	103	11/06→03/16						
CITROËN - SAXO (S0, S1) 02/96→04/04								
 Hauptbremszylinder								
1.0 X	37	05/98→06/03		- ABS; Felge Lochzahl: 3		03.2120-4166.3 010452	ATE Ø 20,6	
1.1 BiFuel	44	07/00→06/03				24.2120-1722.3 010544	Ø 20,6	
1.1 X	40	05/96→09/03						
	44							
SX	40	05/96→09/03		- ABS; Felge Lochzahl: 4		24.2119-1708.3 010543	BDX Ø 19	
	44							
→								

	kw			 	! #		
CITROËN - SAXO (S0, S1) 02/96→04/04							
 Hauptbremszylinder							
1.4 VTS 1.5 D	55 40 - 43	05/96→06/03 09/96→04/04		- ABS		03.2120-4166.3 010452 24.2120-1722.3 010544	ATE Ø 20,6 Ø 20,6
1.6 VTR 1.6 VTL 1.6 VTS Electric	66 - 88 65 65 72 20	02/96→04/04 05/96→06/03 05/96→06/03 09/00→09/03 11/96→06/03				24.2119-1708.3 010543	BDX Ø 19
1.6 VTS	87	06/96→09/03		07/96→; - ABS		03.2120-4166.3 010452 24.2120-1722.3 010544	ATE Ø 20,6 Ø 20,6
				07/96→		24.2119-1708.3 010543	BDX Ø 19
CITROËN - SAXO Hatchback van (S3_) 10/97→06/03							
 Hauptbremszylinder							
1.0	33 - 37	10/97→06/03		- ABS; Felge Lochzahl: 3		03.2120-4166.3 010452 24.2120-1722.3 010544	ATE Ø 20,6 Ø 20,6
				- ABS; Felge Lochzahl: 4		24.2119-1708.3 010543	BDX Ø 19
1.5 D	42 - 43	08/99→06/03		- ABS		03.2120-4166.3 010452 24.2120-1722.3 010544	ATE Ø 20,6 Ø 20,6
						24.2119-1708.3 010543	BDX Ø 19
CITROËN - XSARA (N1) 04/97→12/05							
 Bremskraftverstärker							
1.4 HDi	50	01/03→03/05		für Linkslenker; + ABS		03.7853-0902.4 300150	ATE Ø 9" pneumatisch
1.4 i 1.9 D 2.0 HDi 90	55 51 66	04/97→03/05 07/98→03/05 02/99→03/05		→ 08/00 Orga 09002→; für Linkslenker; + ABS		03.7750-9302.4 300116 03.7853-0902.4 300150	ATE Ø 9" pneumatisch ATE Ø 9" pneumatisch
1.4 LPG	55	05/98→08/00				03.7750-9302.4 300116 03.7853-0902.4 300150	ATE Ø 9" pneumatisch ATE Ø 9" pneumatisch
1.5 D 1.6 i 1.8 D 1.8 i 1.8 i Aut. 1.9 D 1.9 SD 1.9 TD	42 65 43 66 74 50 55 66	04/97→09/00 04/97→09/00 04/97→09/00 04/97→09/00 04/97→09/00 04/97→09/00 01/98→09/00 04/97→09/00		→ 08/00		03.7750-9302.4 300116	ATE Ø 9" pneumatisch
1.6 16V 2.0 16V 2.0 HDi 109	80 100 80	09/00→03/05 09/00→03/05 05/01→03/05		Orga 09002→; für Linkslenker; + ABS		03.7853-0902.4 300150	ATE Ø 9" pneumatisch
1.9 D	52	04/00→04/05		→ 08/00		03.7750-9302.4 300116	ATE Ø 9" pneumatisch
				Orga 09002→; → 03/05; für Linkslenker; + ABS		03.7853-0902.4 300150	ATE Ø 9" pneumatisch
 Hauptbremszylinder							
1.4 HDi	50	01/03→03/05		+ ESP		03.2123-2761.3 010886	ATE Ø 23,8
				- ABS		03.2123-2781.3 010631	ATE Ø 23,8
1.4 i 1.9 D 2.0 HDi 90	55 51 66	04/97→03/05 07/98→03/05 02/99→03/05		→ 08/00; + ABS		03.2122-1351.3 010528 24.2122-1733.3 010668	Ø 22,2 Ø 22,2
				→ 08/00; - ABS		03.2122-1356.3 010529 24.2122-1743.3 010712	Ø 22,2 Ø 22,2
				Orga 09065→; + ESP		03.2123-2761.3 010886	ATE Ø 23,8
				Orga 09002→; - ABS		03.2123-2781.3 010631	ATE Ø 23,8
				09/00→; →Orga 09001; - ABS		24.2123-1714.3 010587	BDX Ø 23,8
				09/00→; →Orga 09001; + ABS		24.2123-1715.3 010520	BDX Ø 23,8
1.4 LPG	55	05/98→08/00		+ ABS		03.2122-1351.3 010528 24.2122-1733.3 010668	Ø 22,2 Ø 22,2
				- ABS		03.2122-1356.3 010529 24.2122-1743.3 010712	Ø 22,2 Ø 22,2
				Orga 09065→; + ESP		03.2123-2761.3 010886	ATE Ø 23,8
				Orga 09002→; - ABS		03.2123-2781.3 010631	ATE Ø 23,8
1.5 D 1.6 i 1.8 D 1.8 i 1.8 i Aut. 1.9 D 1.9 SD →	42 65 43 66 74 50 55	04/97→09/00 04/97→09/00 04/97→09/00 04/97→09/00 04/97→09/00 04/97→09/00 01/98→09/00		→ 08/00; + ABS		03.2122-1351.3 010528 24.2122-1733.3 010668	Ø 22,2 Ø 22,2
				→ 08/00; - ABS		03.2122-1356.3 010529 24.2122-1743.3 010712	Ø 22,2 Ø 22,2

CITROËN - XSARA (N1) 04/97→12/05

Hauptbremszylinder

1.9 TD	66	04/97→09/00	→ 08/00; + ABS	03.2122-1351.3 010528	Ø 22,2
				24.2122-1733.3 010668	Ø 22,2
			→ 08/00; - ABS	03.2122-1356.3 010529	Ø 22,2
				24.2122-1743.3 010712	Ø 22,2
1.6 16V 2.0 HDi 109	80	09/00→03/05	Orga 09065→; + ESP	03.2123-2761.3 010886	ATE Ø 23,8
	80	05/01→03/05	Orga 09002→; - ABS	03.2123-2781.3 010631	ATE Ø 23,8
			→Orga 09001; - ABS	24.2123-1714.3 010587	BDX Ø 23,8
			→Orga 09001; + ABS	24.2123-1715.3 010520	BDX Ø 23,8
1.8 BiFuel	82	07/97→08/00	- ABS	24.2123-1714.3 010587	BDX Ø 23,8
			+ ABS	24.2123-1715.3 010520	BDX Ø 23,8
1.8 i 16V 2.0 16V	81	04/97→09/00	→ 08/00; - ABS	24.2123-1714.3 010587	BDX Ø 23,8
	97	07/98→09/00	→ 08/00; + ABS	24.2123-1715.3 010520	BDX Ø 23,8
1.9 D	52	04/00→04/05	→ 08/00; + ABS	03.2122-1351.3 010528	Ø 22,2
				24.2122-1733.3 010668	Ø 22,2
			→ 08/00; - ABS	03.2122-1356.3 010529	Ø 22,2
				24.2122-1743.3 010712	Ø 22,2
			Orga 09065→; → 03/05; + ESP	03.2123-2761.3 010886	ATE Ø 23,8
			Orga 09002→; → 03/05; - ABS	03.2123-2781.3 010631	ATE Ø 23,8
			09/00→; →Orga 09001; - ABS	24.2123-1714.3 010587	BDX Ø 23,8
09/00→; →Orga 09001; + ABS	24.2123-1715.3 010520	BDX Ø 23,8			
2.0 16V	100	09/00→03/05	Orga 09065→; + ESP	03.2123-2761.3 010886	ATE Ø 23,8
			Orga 09002→; - ABS	03.2123-2781.3 010631	ATE Ø 23,8

CITROËN - XSARA Break (N2) 10/97→03/10

Bremskraftverstärker











1.4 HDi	50	01/03→08/05	für Linkslenker; + ABS	03.7853-0902.4 300150	ATE Ø 9" pneumatisch
1.4 i	55	10/97→08/05	→ 08/00; - ABS	03.7750-9302.4 300116	ATE Ø 9" pneumatisch
1.9 D	51	07/98→08/05	Orga 09002→; für Linkslenker; + ABS	03.7853-0902.4 300150	ATE Ø 9" pneumatisch
2.0 HDi 90	66	02/99→08/05			
1.5 D	42	10/97→09/00	→ 08/00; - ABS	03.7750-9302.4 300116	ATE Ø 9" pneumatisch
1.6 i	65	10/97→09/00			
1.8 D	43	10/97→09/00			
1.9 D	50 -	10/97→09/00			
	55				
1.9 TD	66	10/97→09/00			
1.6 16V 2.0 16V 2.0 HDi 109	80 100 80	09/00→08/05 09/00→08/05 05/01→08/05	Orga 09002→; für Linkslenker; + ABS	03.7853-0902.4 300150	ATE Ø 9" pneumatisch













Hauptbremszylinder











1.4 HDi	50	01/03→08/05	+ ESP	03.2123-2761.3 010886	ATE Ø 23,8
			- ABS	03.2123-2781.3 010631	ATE Ø 23,8
1.4 i	55	10/97→08/05	→ 08/00; - ABS	03.2122-1356.3 010529	Ø 22,2
			Orga 09065→; + ESP	03.2123-2761.3 010886	ATE Ø 23,8
			Orga 09002→; - ABS	03.2123-2781.3 010631	ATE Ø 23,8
			→Orga 09001; - ABS	24.2123-1714.3 010587	BDX Ø 23,8
			→Orga 09001; + ABS	24.2123-1715.3 010520	BDX Ø 23,8
1.5 D	42	10/97→09/00	→ 08/00; - ABS	03.2122-1356.3 010529	Ø 22,2
1.6 i	65	10/97→09/00			
1.8 D	43	10/97→09/00			
1.9 D	50	10/97→09/00			
1.6 16V 2.0 16V 2.0 HDi 109 2.0 HDi 90	80 100 80 66	09/00→08/05 09/00→08/05 05/01→08/05 02/99→08/05	Orga 09065→; + ESP	03.2123-2761.3 010886	ATE Ø 23,8
			Orga 09002→; - ABS	03.2123-2781.3 010631	ATE Ø 23,8
			→Orga 09001; - ABS	24.2123-1714.3 010587	BDX Ø 23,8
			→Orga 09001; + ABS	24.2123-1715.3 010520	BDX Ø 23,8
1.8 i	66	10/97→09/00	→ 08/00; - ABS	24.2123-1714.3 010587	BDX Ø 23,8
1.8 i 16V	81	10/97→09/00			
1.8 i Aut.	74	10/97→09/00			
1.9 D	55	01/98→09/00			
1.9 TD	66	10/97→09/00			
2.0 16V	97	07/98→09/00	→ 08/00; + ABS	24.2123-1715.3 010520	BDX Ø 23,8
1.8 LPG	81	05/98→08/00			
			- ABS	24.2123-1714.3 010587	BDX Ø 23,8
			+ ABS	24.2123-1715.3 010520	BDX Ø 23,8
1.9 D	51	07/98→08/05	Orga 09065→; + ESP	03.2123-2761.3 010886	ATE Ø 23,8
			Orga 09002→; - ABS	03.2123-2781.3 010631	ATE Ø 23,8













	kW				! #		
CITROËN - XSARA Coupe (N0) 01/98→04/05							
Bremskraftverstärker							
1.4 HDi	50	01/03→03/05		für Linkslenker; + ABS	03.7853-0902.4	300150	ATE Ø 9" pneumatisch
1.4 i	55	03/98→03/05		→ 08/00	03.7750-9302.4	300116	ATE Ø 9" pneumatisch
1.9 D	51	02/99→03/05		Orga 09002→; für Linkslenker; + ABS	03.7853-0902.4	300150	ATE Ø 9" pneumatisch
2.0 HDi 90	66	02/99→03/05					
1.6 16V	80	09/00→03/05		Orga 09002→; für Linkslenker; + ABS	03.7853-0902.4	300150	ATE Ø 9" pneumatisch
2.0 16V	100	09/00→03/05					
2.0 HDi 109	80	05/01→03/05					
2.0 i 16V	120	02/98→03/05					
1.6 i	65	02/98→09/00		→ 08/00	03.7750-9302.4	300116	ATE Ø 9" pneumatisch
1.8 i	66 - 74	02/98→09/00					
1.8 i 16V	81	02/98→09/00					
1.9 D	50	02/98→09/00					
1.9 TD	66	02/98→09/00					
1.8 LPG	82	01/98→08/00	02/98→				
1.9 D	55	02/98→05/99					
Hauptbremszylinder							
1.4 HDi	50	01/03→03/05		+ ESP	03.2123-2761.3	010886	ATE Ø 23,8
				- ABS	03.2123-2781.3	010631	ATE Ø 23,8
1.4 i 1.9 D 2.0 HDi 90	55 51 66	03/98→03/05 02/99→03/05 02/99→03/05		→ 08/00; + ABS	03.2122-1351.3	010528	Ø 22,2
				→ 08/00; - ABS	24.2122-1733.3	010668	Ø 22,2
				→ 08/00; - ABS	03.2122-1356.3	010529	Ø 22,2
				→ 08/00; - ABS	24.2122-1743.3	010712	Ø 22,2
				Orga 09065→; + ESP	03.2123-2761.3	010886	ATE Ø 23,8
				Orga 09002→; - ABS	03.2123-2781.3	010631	ATE Ø 23,8
				09/00→; →Orga 09001; - ABS	24.2123-1714.3	010587	BDX Ø 23,8
				09/00→; →Orga 09001; + ABS	24.2123-1715.3	010520	BDX Ø 23,8
1.6 16V 2.0 16V 2.0 HDi 109 2.0 i 16V	80 100 80 120	09/00→03/05 09/00→03/05 05/01→03/05 02/98→03/05		Orga 09065→; + ESP	03.2123-2761.3	010886	ATE Ø 23,8
				Orga 09002→; - ABS	03.2123-2781.3	010631	ATE Ø 23,8
				→Orga 09001; - ABS	24.2123-1714.3	010587	BDX Ø 23,8
				→Orga 09001; + ABS	24.2123-1715.3	010520	BDX Ø 23,8
1.6 i 1.8 i	65 66 - 74	02/98→09/00 02/98→09/00		→ 08/00; + ABS	03.2122-1351.3	010528	Ø 22,2
				→ 08/00; - ABS	24.2122-1733.3	010668	Ø 22,2
1.9 D 1.9 TD	50 66	02/98→09/00 02/98→09/00		→ 08/00; - ABS	03.2122-1356.3	010529	Ø 22,2
				→ 08/00; - ABS	24.2122-1743.3	010712	Ø 22,2
1.8 i 16V	81	02/98→09/00		→ 08/00; - ABS	24.2123-1714.3	010587	BDX Ø 23,8
				→ 08/00; + ABS	24.2123-1715.3	010520	BDX Ø 23,8
1.8 LPG	82	01/98→08/00		02/98→; - ABS	24.2123-1714.3	010587	BDX Ø 23,8
				02/98→; + ABS	24.2123-1715.3	010520	BDX Ø 23,8
1.9 D	55	02/98→05/99		+ ABS	03.2122-1351.3	010528	Ø 22,2
				- ABS	24.2122-1733.3	010668	Ø 22,2
				- ABS	03.2122-1356.3	010529	Ø 22,2
				- ABS	24.2122-1743.3	010712	Ø 22,2
CITROËN - XSARA Kasten/Kombi 05/98→08/05							
Bremskraftverstärker							
1.4 2.0 HDi	55 66	09/00→03/05 09/00→03/05		Orga 09002→; für Linkslenker; + ABS	03.7853-0902.4	300150	ATE Ø 9" pneumatisch
1.8 D	43	05/98→05/99		- ABS	03.7750-9302.4	300116	ATE Ø 9" pneumatisch
1.9 D	51	06/99→08/05		→ 08/00; - ABS	03.7750-9302.4	300116	ATE Ø 9" pneumatisch
				Orga 09002→; für Linkslenker; + ABS	03.7853-0902.4	300150	ATE Ø 9" pneumatisch
Hauptbremszylinder							
1.4 2.0 HDi	55 66	09/00→03/05 09/00→03/05		Orga 09065→; + ESP	03.2123-2761.3	010886	ATE Ø 23,8
				Orga 09002→; - ABS	03.2123-2781.3	010631	ATE Ø 23,8
				→Orga 09001; - ABS	24.2123-1714.3	010587	BDX Ø 23,8
				→Orga 09001; + ABS	24.2123-1715.3	010520	BDX Ø 23,8
1.8 D	43	05/98→05/99		- ABS	03.2122-1356.3	010529	Ø 22,2
				+ ABS	24.2123-1714.3	010587	BDX Ø 23,8
				+ ABS	24.2123-1715.3	010520	BDX Ø 23,8
1.9 D	51	06/99→08/05		Orga 09065→; + ESP	03.2123-2761.3	010886	ATE Ø 23,8
				Orga 09002→; - ABS	03.2123-2781.3	010631	ATE Ø 23,8































	kw					! #		
CITROËN - XSARA Kasten/Schrägheck (N3_) 05/98→03/05								
 Bremskraftverstärker								
1.4 1.9 D	55 51	05/98→10/04 06/99→03/05		→ 08/00		03.7750-9302.4	300116	ATE Ø 9" pneumatisch
				Orga 09002→; für Linkslenker; + ABS		03.7853-0902.4	300150	ATE Ø 9" pneumatisch
1.4 LPG	55	06/99→08/00				03.7750-9302.4	300116	ATE Ø 9" pneumatisch
				Orga 09002→; für Linkslenker; + ABS		03.7853-0902.4	300150	ATE Ø 9" pneumatisch
1.8 D 1.9 D	43 65	05/98→05/99 05/98→08/00				03.7750-9302.4	300116	ATE Ø 9" pneumatisch
2.0 HDi	66	09/00→03/05		Orga 09002→; für Linkslenker; + ABS		03.7853-0902.4	300150	ATE Ø 9" pneumatisch
 Hauptbremszylinder								
1.4 1.9 D	55 51	05/98→10/04 06/99→03/05		→ 08/00; + ABS		03.2122-1351.3	010528	Ø 22,2
						24.2122-1733.3	010668	Ø 22,2
				→ 08/00; - ABS		03.2122-1356.3	010529	Ø 22,2
						24.2122-1743.3	010712	Ø 22,2
				Orga 09065→; + ESP		03.2123-2761.3	010886	ATE Ø 23,8
				Orga 09002→; - ABS		03.2123-2781.3	010631	ATE Ø 23,8
				09/00→; →Orga 09001; - ABS		24.2123-1714.3	010587	BDX Ø 23,8
				09/00→; →Orga 09001; + ABS		24.2123-1715.3	010520	BDX Ø 23,8
1.4 LPG	55	06/99→08/00		+ ABS		03.2122-1351.3	010528	Ø 22,2
						24.2122-1733.3	010668	Ø 22,2
				- ABS		03.2122-1356.3	010529	Ø 22,2
						24.2122-1743.3	010712	Ø 22,2
				Orga 09065→; + ESP		03.2123-2761.3	010886	ATE Ø 23,8
				Orga 09002→; - ABS		03.2123-2781.3	010631	ATE Ø 23,8
1.8 D 1.9 D	43 65	05/98→05/99 05/98→08/00		+ ABS		03.2122-1351.3	010528	Ø 22,2
						24.2122-1733.3	010668	Ø 22,2
				- ABS		03.2122-1356.3	010529	Ø 22,2
						24.2122-1743.3	010712	Ø 22,2
2.0 HDi	66	09/00→03/05		Orga 09065→; + ESP		03.2123-2761.3	010886	ATE Ø 23,8
				Orga 09002→; - ABS		03.2123-2781.3	010631	ATE Ø 23,8
				→Orga 09001; - ABS		24.2123-1714.3	010587	BDX Ø 23,8
				→Orga 09001; + ABS		24.2123-1715.3	010520	BDX Ø 23,8
CITROËN - XSARA PICASSO (N68) 09/99→06/12								
 Hauptbremszylinder								
1.6	65	12/99→09/01		für DAM-Nummer ab: 0882078 →; für Linkslenker; - ABS		03.2123-2781.3	010631	ATE Ø 23,8
				06/00→; - ABS		24.2123-1714.3	010587	BDX Ø 23,8
1.6	67	06/02→08/05		Orga 08820→; für Linkslenker; - ABS		03.2123-2781.3	010631	ATE Ø 23,8
				- ABS		24.2123-1714.3	010587	BDX Ø 23,8
1.6	70	12/99→12/10		für DAM-Nummer ab: 0882078 →; → 03/10; für Linkslenker; - ABS		03.2123-2781.3	010631	ATE Ø 23,8
				09/00→ 03/10; - ABS		24.2123-1714.3	010587	BDX Ø 23,8
1.6 16V 1.6 16V LPG 2.0	80 80 88	09/05→12/11 06/04→12/10 02/04→10/04		für Linkslenker; - ABS		03.2123-2781.3	010631	ATE Ø 23,8
				- ABS		24.2123-1714.3	010587	BDX Ø 23,8
1.6 16V	81	06/05→09/06		09/05→; für Linkslenker; - ABS		03.2123-2781.3	010631	ATE Ø 23,8
				09/05→; - ABS		24.2123-1714.3	010587	BDX Ø 23,8
1.6 Chrono 1.8 16V	74 85	04/01→10/04 02/00→08/05		für DAM-Nummer ab: 0882078 →; für Linkslenker; - ABS		03.2123-2781.3	010631	ATE Ø 23,8
				- ABS		24.2123-1714.3	010587	BDX Ø 23,8
1.6 HDi	66 - 80	05/04→12/11		→ 03/10; für Linkslenker; - ABS		03.2123-2781.3	010631	ATE Ø 23,8
2.0 16V	100	01/03→06/12		→ 03/10; - ABS		24.2123-1714.3	010587	BDX Ø 23,8
2.0 16V	101	12/99→11/11		01/03→ 03/10; für Linkslenker; - ABS		03.2123-2781.3	010631	ATE Ø 23,8
				01/03→ 03/10; - ABS		24.2123-1714.3	010587	BDX Ø 23,8
2.0 HDi	66	12/99→12/11		für DAM-Nummer ab: 0882078 →; → 03/10; für Linkslenker; - ABS		03.2123-2781.3	010631	ATE Ø 23,8
				06/00→ 03/10; - ABS		24.2123-1714.3	010587	BDX Ø 23,8
CUPRA - ATECA (KH7, KHP, KBP) 09/18→								
 Hauptbremszylinder								
2.0 TSI 4Drive	140 - 221	09/18→		für Linkslenker		24.4123-1719.3	011017	TRW Ø 23,8 ohne Bremsflüssigkeitsbehälter
						24.4153-1522.3	011048	ATE Ø 23,8 ohne Bremsflüssigkeitsbehälter

















	kW					! #		
DACIA - DOKKER Express Kasten/Großraumlimousine 11/12→								
 Hauptbremszylinder								
1.2 TCe 115	84	12/12→		- ESP			24.4152-0381.3 011032	ATE Ø 22,2 ohne Bremsflüssigkeitsbehälter
1.3 TCe 100	85	08/19→		+ ESP			24.4152-0391.3 011033	ATE Ø 22,2 ohne Bremsflüssigkeitsbehälter
1.3 TCe 130	75	08/19→						
1.5 Blue dCi 95	96	08/19→						
1.5 dCi	70	06/19→						
1.5 dCi 75 / Blue dCi 75	62 - 66	11/12→						
1.6	61 - 75	12/12→						
1.6 LPG	61 - 80	11/13→						
DACIA - DOKKER Großraumlimousine (KE_) 11/12→								
 Hauptbremszylinder								
1.2 TCe	85	11/12→		- ESP			24.4152-0381.3 011032	ATE Ø 22,2 ohne Bremsflüssigkeitsbehälter
1.3 TCe 100	75	08/19→		+ ESP			24.4152-0391.3 011033	ATE Ø 22,2 ohne Bremsflüssigkeitsbehälter
1.3 TCe 130	96	03/19→						
1.5 Blue dCi 95	70	12/18→						
1.5 dCi / Blue dCi 75	55	11/12→						
1.5 dCi	63 - 66	11/12→						
1.6	61 - 75	11/12→						
1.6 LPG	61 - 80	11/13→						
DACIA - DUSTER (HS_) 04/10→01/18								
 Bremskraftverstärker								
1.5 dCi	63 - 79	04/10→01/18		→ 10/13; + ABS			03.7853-4602.4 300302	ATE Ø 9" pneumatisch
1.5 dCi 4x4	66 - 81	10/10→01/18						
1.6 16V	77	04/10→01/18						
1.6 16V 4x4	77	06/10→01/18						
1.6 16V LPG	77	04/11→01/18						
1.5 dCi 4x4	80	08/13→01/18			+ ABS			
1.6 16V Hi-Flex	77	08/10→01/18		04/11→ 10/13; + ABS			03.7853-4602.4 300302	ATE Ø 9" pneumatisch
 Hauptbremszylinder								
1.2 TCe 125	92	10/13→01/18		+ ABS / - ESP			24.4152-0381.3 011032	ATE Ø 22,2 ohne Bremsflüssigkeitsbehälter
1.2 TCe 125 4x4	92	06/15→01/18		+ ABS / + ESP			24.4152-0391.3 011033	ATE Ø 22,2 ohne Bremsflüssigkeitsbehälter
1.6 SCe 115	84	06/15→01/18						
1.5 dCi	63 - 79	04/10→01/18		→ 10/13; - ESP			03.2122-2031.3 010938	ATE Ø 22,2
1.5 dCi 4x4	66 - 81	10/10→01/18		→ 10/13; + ESP			03.2122-2261.3 010964	ATE Ø 22,2
1.6 16V	77	04/10→01/18		11/13→; + ABS / - ESP			24.4152-0381.3 011032	ATE Ø 22,2 ohne Bremsflüssigkeitsbehälter
1.6 16V 4x4	77	06/10→01/18						
1.6 16V LPG	77	04/11→01/18						
1.5 dCi 4x4	80	08/13→01/18		+ ABS / - ESP			03.2122-2031.3 010938	ATE Ø 22,2
				+ ABS / + ESP			03.2122-2261.3 010964	ATE Ø 22,2
1.6 16V Hi-Flex	77	08/10→01/18		04/11→ 10/13; - ESP			03.2122-2031.3 010938	ATE Ø 22,2
				11/13→; + ABS / - ESP			24.4152-0381.3 011032	ATE Ø 22,2 ohne Bremsflüssigkeitsbehälter
1.6 SCe 115 4x4	84	06/15→01/18		für Linkslenker; + ABS / - ESP			24.4152-0381.3 011032	ATE Ø 22,2 ohne Bremsflüssigkeitsbehälter
				für Linkslenker; + ABS / + ESP			24.4152-0391.3 011033	ATE Ø 22,2 ohne Bremsflüssigkeitsbehälter
1.6 SCe 115 LPG	84	06/15→01/18		für Linkslenker; + ABS / - ESP			24.4152-0381.3 011032	ATE Ø 22,2 ohne Bremsflüssigkeitsbehälter
				+ ABS / + ESP			24.4152-0391.3 011033	ATE Ø 22,2 ohne Bremsflüssigkeitsbehälter
DACIA - DUSTER Kasten/SUV 04/11→								
 Bremskraftverstärker								
1.5 dCi	66	04/11→		→ 10/13; + ABS			03.7853-4602.4 300302	ATE Ø 9" pneumatisch
1.5 dCi 4x4	66	04/11→						
1.6 16V	77	04/11→						
1.6 16V 4x4	77	04/11→						
1.6 16V Hi-Flex	77	04/11→						
1.5 dCi 4x4	80	04/13→		08/13→; + ABS			03.7853-4602.4 300302	ATE Ø 9" pneumatisch
→								















	kw					! #		
DACIA - DUSTER Kasten/SUV 04/11→								
 Hauptbremszylinder								
1.2 TCe 125 4x4	92	10/13→		06/15→; + ABS / - ESP		24.4152-0381.3	011032	ATE Ø 22,2 ohne Bremsflüssigkeitsbehälter
				06/15→; + ABS / + ESP		24.4152-0391.3	011033	ATE Ø 22,2 ohne Bremsflüssigkeitsbehälter
1.5 dCi	66	04/11→		→ 10/13; - ESP		03.2122-2031.3	010938	ATE Ø 22,2
1.5 dCi 4x4	66	04/11→		→ 10/13; + ESP		03.2122-2261.3	010964	ATE Ø 22,2
1.6 16V 4x4	77	04/11→		11/13→; + ABS / - ESP		24.4152-0381.3	011032	ATE Ø 22,2 ohne Bremsflüssigkeitsbehälter
				11/13→; + ABS / + ESP		24.4152-0391.3	011033	ATE Ø 22,2 ohne Bremsflüssigkeitsbehälter
1.5 dCi 4x4	80	04/13→		08/13→; + ABS / - ESP		03.2122-2031.3	010938	ATE Ø 22,2
				08/13→; + ABS / + ESP		03.2122-2261.3	010964	ATE Ø 22,2
1.6 16V	77	04/11→		→ 10/13; - ESP		03.2122-2031.3	010938	ATE Ø 22,2
1.6 16V Hi-Flex	77	04/11→		11/13→; + ABS / - ESP		24.4152-0381.3	011032	ATE Ø 22,2 ohne Bremsflüssigkeitsbehälter
1.6 SCe 115	84	06/15→		+ ABS / - ESP		24.4152-0381.3	011032	ATE Ø 22,2 ohne Bremsflüssigkeitsbehälter
1.6 SCe 115 LPG	84	06/15→01/18		+ ABS / + ESP		24.4152-0391.3	011033	ATE Ø 22,2 ohne Bremsflüssigkeitsbehälter
1.6 SCe 115 4x4	84	06/15→01/18		für Linkslenker; + ABS / - ESP		24.4152-0381.3	011032	ATE Ø 22,2 ohne Bremsflüssigkeitsbehälter
				für Linkslenker; + ABS / + ESP		24.4152-0391.3	011033	ATE Ø 22,2 ohne Bremsflüssigkeitsbehälter
DACIA - LODGY (JS_) 03/12→								
 Hauptbremszylinder								
1.2 TCe	85	03/12→		- ESP		24.4152-0381.3	011032	ATE Ø 22,2 ohne Bremsflüssigkeitsbehälter
1.3 TCe 100	75	01/19→						
1.3 TCe 130	96	01/19→		+ ESP		24.4152-0391.3	011033	ATE Ø 22,2 ohne Bremsflüssigkeitsbehälter
1.5 Blue dCi 115	85	08/18→						
1.5 Blue dCi 95	70	08/18→						
1.5 dCi	63 -	03/12→						
	81							
1.6	61	03/12→						
1.6 LPG	61 -	11/13→						
	80							
1.6 SCe 100	75	06/15→		für Linkslenker; - ESP		24.4152-0381.3	011032	ATE Ø 22,2 ohne Bremsflüssigkeitsbehälter
				für Linkslenker; + ESP		24.4152-0391.3	011033	ATE Ø 22,2 ohne Bremsflüssigkeitsbehälter
DACIA - LOGAN (LS_) 08/04→								
 Bremskraftverstärker								
1.2 16V	55	02/06→		→ 04/13		03.7853-4602.4	300302	ATE Ø 9" pneumatisch
1.2 16V LPG	55	02/06→						
1.5 dCi	65	05/10→						
1.6 Bifuel	62	05/10→						
1.6 MPI 85	62	05/10→						
1.5 dCi	55	05/10→12/12				03.7853-4602.4	300302	ATE Ø 9" pneumatisch
1.5 dCi	63	09/07→12/11		+ ABS		03.7750-8532.4	300264	ATE Ø 9" pneumatisch
1.6	64	09/04→						
1.6 LPG	64	08/04→03/11						
1.6 16V Flexifuel	77	07/10→		01/11→ 04/13		03.7853-4602.4	300302	ATE Ø 9" pneumatisch
 Hauptbremszylinder								
1.2 16V	55	02/06→		+ ABS; → 04/13		03.2120-4611.3	010937	ATE Ø 20,6
1.2 16V LPG	55	02/06→						
1.5 dCi	65	05/10→		- ABS; → 04/13		24.2120-1762.3	011002	Ø 20,6 ohne Bremsflüssigkeitsbehälter
1.6 Bifuel	62	05/10→						
1.6 MPI 85	62	05/10→						
1.4	55	09/04→		→ 04/13; + ABS		24.2120-1754.3	010949	Ø 20,6
1.5 dCi	48	09/05→						
1.6 16V	77	02/06→		- ABS; → 04/13		24.2120-1762.3	011002	Ø 20,6 ohne Bremsflüssigkeitsbehälter
1.4 MPI LPG	55	02/06→12/12		+ ABS		24.2120-1754.3	010949	Ø 20,6
1.5 dCi	50	01/06→12/12		- ABS		24.2120-1762.3	011002	Ø 20,6 ohne Bremsflüssigkeitsbehälter
1.6	64	09/04→						
1.6 LPG	64	08/04→03/11						
1.5 dCi	55 -	09/07→12/12		+ ABS		03.2120-4611.3	010937	ATE Ø 20,6
	63			- ABS		24.2120-1762.3	011002	Ø 20,6 ohne Bremsflüssigkeitsbehälter
1.6 16V Flexifuel	77	07/10→		01/11→; + ABS; → 04/13		03.2120-4611.3	010937	ATE Ø 20,6
→								













	kw			 	! #		
DACIA - LOGAN (LS_) 08/04→							
 Hauptbremszylinder							
1.6 16V Flexifuel	77	07/10→		01/11→; - ABS; → 04/13		24.2120-1762.3 011002	Ø 20,6 ohne Bremsflüssigkeitsbehälter
DACIA - LOGAN II 10/12→							
 Hauptbremszylinder							
1.0 LPG 1.0 SCe 75 1.0 TCe 100 1.6	74 54 74 59 - 63	11/19→ 01/17→ 11/19→ 06/13→		für Linkslenker		24.4120-1771.3 011076	Ø 20,6 ohne Bremsflüssigkeitsbehälter
1.2 1.2 LPG 1.5 Blue dCi 95 1.5 dCi 1.5 dCi / Blue dCi 75 1.6 16V TCe 90 TCe 90 LPG	54 - 55 53 - 55 70 63 - 66 55 77 66 66	10/12→ 10/12→ 05/18→ 10/12→ 10/12→ 01/13→ 10/12→ 09/15→		für Linkslenker; + ABS		24.4120-1771.3 011076	Ø 20,6 ohne Bremsflüssigkeitsbehälter
DACIA - LOGAN EXPRESS (FS_) 10/07→							
 Bremskraftverstärker							
1.4 1.5 dCi 1.6 MPI 85 1.5 dCi 1.6 LPG	55 50 - 65 62 48 62	03/09→ 03/09→ 05/10→ 10/07→12/12 05/10→12/12		→ 06/13 + ABS; → 06/13 + ABS + ABS; → 01/11 + ABS; 02/11→		03.7750-8532.4 300264 03.7750-8532.4 300264 03.7750-8532.4 300264 03.7750-8532.4 300264 03.7853-4602.4 300302	ATE Ø 9" pneumatisch ATE Ø 9" pneumatisch ATE Ø 9" pneumatisch ATE Ø 9" pneumatisch ATE Ø 9" pneumatisch
 Hauptbremszylinder							
1.4 1.5 dCi 1.6 MPI 85 1.5 dCi 1.6 LPG	55 50 - 65 62 48 62	03/09→ 03/09→ 05/10→ 10/07→12/12 05/10→12/12		+ ABS; → 06/13 - ABS; → 06/13 + ABS; → 06/13 + ABS		03.2122-2031.3 010938 24.2120-1762.3 011002 03.2122-2031.3 010938 03.2122-2031.3 010938	ATE Ø 22,2 Ø 20,6 ohne Bremsflüssigkeitsbehälter ATE Ø 22,2 ATE Ø 22,2
DACIA - LOGAN MCV (KS_) 02/07→							
 Bremskraftverstärker							
1.4 1.5 dCi 1.6 1.6 16V 1.6 16V Hi-Flex 1.6 Bifuel 1.5 dCi 1.6 MPI 85	55 48 - 65 64 77 77 62 - 64 63 62	02/07→ 02/07→ 02/07→06/13 02/07→ 11/09→ 11/08→ 09/07→12/12 05/10→		→ 04/13; + ABS + ABS + ABS		03.7750-8532.4 300264 03.7750-8532.4 300264 03.7853-4602.4 300302	ATE Ø 9" pneumatisch ATE Ø 9" pneumatisch ATE Ø 9" pneumatisch
 Hauptbremszylinder							
1.4 1.5 dCi 1.6 1.6 16V 1.5 dCi 1.6 16V Hi-Flex 1.5 dCi 1.6 Bifuel 1.6 MPI 85	55 48 - 50 64 77 55 - 65 77 63 62 - 64 62	02/07→ 02/07→ 02/07→06/13 02/07→ 05/10→ 11/09→ 09/07→12/12 11/08→ 05/10→		- ABS; → 04/13 + ABS; → 04/13 - ABS; → 04/13 + ABS - ABS + ABS; → 04/13 - ABS; → 04/13 + ABS; Bosnien-Herzegowina / Kroatien / + RO / + TR		24.2120-1762.3 011002 03.2122-2031.3 010938 24.2120-1762.3 011002 03.2122-2031.3 010938 24.2120-1762.3 011002 24.2120-1754.3 010949 24.2120-1762.3 011002 03.2120-4611.3 010937	Ø 20,6 ohne Bremsflüssigkeitsbehälter ATE Ø 22,2 Ø 20,6 ohne Bremsflüssigkeitsbehälter ATE Ø 22,2 Ø 20,6 ohne Bremsflüssigkeitsbehälter Ø 20,6 ATE Ø 20,6
→							









	kw					! #		
DACIA - LOGAN MCV (KS_) 02/07→								
 Hauptbremszylinder								
1.6 MPI 85	62	05/10→		+ ABS		03.2122-2031.3	010938	ATE Ø 22,2
				- ABS; → 04/13		24.2120-1762.3	011002	Ø 20,6 ohne Bremsflüssigkeitsbehälter
DACIA - LOGAN MCV II 02/13→								
 Hauptbremszylinder								
1.0 LPG 1.0 TCe 100	74 74	11/19→ 11/19→		für Linkslenker		24.4120-1771.3	011076	Ø 20,6 ohne Bremsflüssigkeitsbehälter
1.0 SCe 75 1.2 1.2 LPG 1.5 Blue dCi 95 1.5 dCi 1.6 TCe 90 TCe 90 LPG	54 54 - 55 53 - 55 70 55 - 66 62 66 66	12/16→ 02/13→ 02/13→ 10/18→ 02/13→ 06/13→ 02/13→ 09/15→		für Linkslenker; + ABS		24.4120-1771.3	011076	Ø 20,6 ohne Bremsflüssigkeitsbehälter
DACIA - LOGAN Pick-up (US_) 03/08→								
 Bremskraftverstärker								
1.4 1.5 dCi	55 55 - 65	01/09→ 03/08→		→ 06/13		03.7750-8532.4	300264	ATE Ø 9" pneumatisch
1.6 1.6 Bifuel 1.6 MPI 85	64 62 62	03/08→ 05/10→ 05/10→						
1.5 dCi 1.6 16V	48 77	04/08→12/12 01/10→08/13		+ ABS		03.7750-8532.4	300264	ATE Ø 9" pneumatisch
1.5 dCi	50	03/08→		→ 06/13; + ABS		03.7750-8532.4	300264	ATE Ø 9" pneumatisch
 Hauptbremszylinder								
1.4	55	01/09→		+ ABS; → 06/13		03.2122-2031.3	010938	ATE Ø 22,2
				- ABS; → 06/13		24.2120-1762.3	011002	Ø 20,6 ohne Bremsflüssigkeitsbehälter
1.5 dCi 1.6 1.6 Bifuel 1.6 MPI 85	50 - 65 64 62 62	03/08→ 03/08→ 05/10→ 05/10→		+ ABS; → 06/13		03.2122-2031.3	010938	ATE Ø 22,2
1.5 dCi 1.6 16V	48 77	04/08→12/12 01/10→08/13		+ ABS		03.2122-2031.3	010938	ATE Ø 22,2
DACIA - SANDERO 06/08→								
 Bremskraftverstärker								
1.2 16V 1.2 16V LPG 1.4 1.4 MPI LPG 1.5 dCi	55 55 55 53 48 - 65	11/08→ 11/08→ 06/08→ 01/09→ 11/08→		→ 02/13; + ABS		03.7853-4602.4	300302	ATE Ø 9" pneumatisch
1.6 16V 1.6 MPI 85	77 62	07/11→ 05/10→06/13						
1.5 dCi	63	11/08→		→ 02/13		03.7750-8532.4	300264	ATE Ø 9" pneumatisch
1.6 1.6 16V Bifuel 1.6 Hi-Flex 1.6 LPG	64 77 64 62 - 64	06/08→ 01/11→ 06/08→12/12 06/08→12/12		+ ABS		03.7853-4602.4	300302	ATE Ø 9" pneumatisch
1.6 LPG	60	01/11→12/12		→ 10/12; + ABS		03.7853-4602.4	300302	ATE Ø 9" pneumatisch
 Hauptbremszylinder								
1.2 16V 1.2 16V LPG 1.4 1.4 MPI LPG 1.5 dCi	55 55 55 53 48 - 65	11/08→ 11/08→ 06/08→ 01/09→ 11/08→		→ 02/13; + ABS		03.2120-4611.3	010937	ATE Ø 20,6
1.6 16V 1.6 MPI 85	77 62	07/11→ 05/10→06/13						
1.5 dCi	63	11/08→		→ 02/13; + ABS		03.2122-2031.3	010938	ATE Ø 22,2
1.6 1.6 16V Bifuel 1.6 Hi-Flex	64 77 64	06/08→ 01/11→ 06/08→12/12		+ ABS		03.2120-4611.3	010937	ATE Ø 20,6

	kw					! #		
DACIA - SANDERO 06/08→								
 Hauptbremszylinder								
1.6 LPG	62 - 64	06/08→12/12		- ABS		24.2120-1762.3	011002	Ø 20,6 ohne Bremsflüssigkeitsbehälter
1.6 LPG	60	01/11→12/12		→ 10/12; + ABS		03.2120-4611.3	010937	ATE Ø 20,6
				→ 10/12; - ABS		24.2120-1762.3	011002	Ø 20,6 ohne Bremsflüssigkeitsbehälter
DACIA - SANDERO II 10/12→								
 Hauptbremszylinder								
1.0 LPG	74	11/19→		für Linkslenker; + ABS		24.4120-1771.3	011076	Ø 20,6 ohne Bremsflüssigkeitsbehälter
1.0 SCe 75	54	12/16→						
1.0 TCe 100	74	11/19→						
1.2	54 - 55	10/12→						
1.2 LPG	55	10/12→						
1.5 Blue dCi 95	70	08/18→						
1.5 dCi	63 - 66	10/12→						
1.5 dCi 75 / Blue dCi 75	55	10/12→						
1.6	63	11/12→						
TCe 90	66	10/12→						
TCe 90 LPG	66	09/15→						
DAEWOO - MATIZ (M100, M150) 09/98→								
 Hauptbremszylinder								
1.0	46	04/03→12/04		für Linkslenker; + ABS		24.2120-1755.3	010974	Ø 20,6 ohne Bremsflüssigkeitsbehälter
				für Linkslenker; - ABS		24.2120-1765.3	011003	Ø 20,6 ohne Bremsflüssigkeitsbehälter
1.0	47	01/03→		→ 02/05; für Linkslenker; + ABS		24.2120-1755.3	010974	Ø 20,6 ohne Bremsflüssigkeitsbehälter
				→ 02/05; für Linkslenker; - ABS		24.2120-1765.3	011003	Ø 20,6 ohne Bremsflüssigkeitsbehälter
DAEWOO - MATIZ (M200, M250) 01/05→12/18								
 Hauptbremszylinder								
0.8	38	01/05→06/10		für Linkslenker; + ABS		24.2120-1755.3	010974	Ø 20,6 ohne Bremsflüssigkeitsbehälter
1.0	49	03/05→12/08		für Linkslenker; - ABS		24.2120-1765.3	011003	Ø 20,6 ohne Bremsflüssigkeitsbehälter
DAEWOO - MATIZ (M300) 01/10→11/12								
 Hauptbremszylinder								
1.0	51	01/10→11/12		für Linkslenker; + ABS		24.2120-1755.3	010974	Ø 20,6 ohne Bremsflüssigkeitsbehälter
				für Linkslenker; - ABS		24.2120-1765.3	011003	Ø 20,6 ohne Bremsflüssigkeitsbehälter
DAEWOO - MATIZ Kasten/Schrägheck (KLA4) 08/98→08/02								
 Hauptbremszylinder								
0.8	38	08/98→08/02		für Linkslenker; + ABS		24.2120-1755.3	010974	Ø 20,6 ohne Bremsflüssigkeitsbehälter
				für Linkslenker; - ABS		24.2120-1765.3	011003	Ø 20,6 ohne Bremsflüssigkeitsbehälter
DAIHATSU - CHARADE VIII 05/11→								
 Bremskraftverstärker								
1.33 16V	73	05/11→		→ 01/13; für Linkslenker; + ESP		03.7750-7132.4	300255	ATE Ø 9" pneumatisch
				→ 01/13; für Linkslenker; - ESP		03.7853-3203.4	300241	ATE Ø 9" pneumatisch
 Hauptbremszylinder								
1.33 16V	73	05/11→		→ 01/13; für Linkslenker; - ESP		03.4152-0153.3	011006	ATE Ø 22,2 ohne Bremsflüssigkeitsbehälter
				→ 01/13; für Linkslenker; + ESP		03.4152-0158.3	011007	ATE Ø 22,2 ohne Bremsflüssigkeitsbehälter
DS - DS 5 (KF_) 01/15→12/18								
 Bremskraftverstärker								
1.6 BlueHDi 115	85	06/15→12/18		für Fahrzeuge mit Start-Stopp-Funktion		03.7860-3734.4	300317	ATE Ø 10" pneumatisch
1.6 BlueHDi 120	88	06/15→12/18						

	kW					! #		
DS - DS 5 (KF_) 01/15→12/18								
 Bremskraftverstärker								
1.6 THP 165 1.6 THP 210 2.0 BlueHDi 135 2.0 BlueHDi 150 2.0 BlueHDi 180 Hybrid4	121 155 100 110 133 147	07/15→12/18 04/15→12/18 06/15→12/18 04/15→12/18 04/15→12/18 04/15→12/18		für Fahrzeuge mit Start-Stopp-Funktion		03.7860-3734.4 300317		ATE Ø 10" pneumatisch ATE Ø 10" pneumatisch
 Hauptbremszylinder								
1.6 BlueHDi 115 1.6 BlueHDi 120 1.6 THP 165 1.6 THP 210 2.0 BlueHDi 135 2.0 BlueHDi 150 2.0 BlueHDi 180 Hybrid4	85 88 121 155 100 110 133 147	06/15→12/18 06/15→12/18 07/15→12/18 04/15→12/18 06/15→12/18 04/15→12/18 04/15→12/18 04/15→12/18		82 mm Radnabendurchmesser [mm] 83 mm Radnabendurchmesser [mm]		03.4153-0173.3 010815 24.4155-1236.3 011049		ATE Ø 23,8 ATE Ø 25,4 ohne Bremsflüssigkeitsbehälter
FIAT - 126 (126_) 09/72→09/00								
 Hauptbremszylinder								
650	18	07/81→09/00		→ 08/87		24.2119-0815.3 010347		Ø 19
FIAT - 500 (312_) 07/07→								
 Hauptbremszylinder								
0.9 1.3 D Multijet 1.4 1.4 Turbo	44 - 63 57 74 - 75 101	07/10→ 06/16→ 10/07→ 09/13→				24.4122-1714.3 010914		TRW Ø 22,2 ohne Bremsflüssigkeitsbehälter
0.9 Electric	77 24 - 83	10/13→ 01/10→		12/13→		24.4122-1714.3 010914		TRW Ø 22,2 ohne Bremsflüssigkeitsbehälter
1.2 1.2 LPG 1.3 D Multijet	51 51 55 - 70	07/07→ 12/10→ 10/07→				24.4120-1702.3 010913		TRW Ø 20,6 ohne Bremsflüssigkeitsbehälter
FIAT - 500 C (312_) 09/09→								
 Hauptbremszylinder								
0.9 1.3 D Multijet 1.4	44 - 77 55 - 70 74 - 75	09/09→ 09/09→ 09/09→				24.4122-1714.3 010914		TRW Ø 22,2 ohne Bremsflüssigkeitsbehälter
1.2	51	09/09→				24.4120-1702.3 010913		TRW Ø 20,6 ohne Bremsflüssigkeitsbehälter
FIAT - 500L (351_, 352_) 09/12→								
 Hauptbremszylinder								
0.9 0.9 Natural Power 1.3 D Multijet 1.4 1.4 LPG 1.6 D Multijet	77 59 - 63 62 - 70 70 88 77 - 88	09/12→ 03/13→ 09/12→ 09/12→ 02/14→ 09/12→		für Linkslenker; Schaltgetriebe, automatisch betätigt		24.4122-1734.3 011117		Ø 22,2 ohne Bremsflüssigkeitsbehälter
1.4	88 - 119	09/13→		01/14→; für Linkslenker; Schaltgetriebe, automatisch betätigt		24.4122-1734.3 011117		Ø 22,2 ohne Bremsflüssigkeitsbehälter
FIAT - BARCHETTA (183_) 03/95→05/05								
 Hauptbremszylinder								
1.8 16V	96	04/95→05/05		→ 10/04; GG		24.2122-1716.3 010485		Ø 22,2
 Bremskraftregler								
1.8 16V	96	04/95→05/05		+ ABS; → 10/04; 		24.6513-1705.3 320237		lastabhängig 2x
FIAT - BRAVA (182_) 10/95→06/03								
 Hauptbremszylinder								
1.2 16V 80 1.4 →	59 55	10/00→10/01 10/95→10/01		für Linkslenker; GG		24.2122-1716.3 010485		Ø 22,2

	kw			 	! #		
FIAT - BRAVA (182_) 10/95→06/03							
 Hauptbremszylinder							
1.6 16V	66 - 76	10/95→12/02		für Linkslenker; GG		24.2122-1716.3 010485	Ø 22,2
1.8 GT 16V	83	10/95→08/01					
1.9 D	48	10/95→10/01					
1.9 JTD	74	09/00→10/01					
1.9 JTD 105	77	12/98→10/01					
1.2 16V 80	60	12/98→12/02		→ 10/01; für Linkslenker; GG		24.2122-1716.3 010485	Ø 22,2
1.9 TD 100 S	74	03/96→10/01		06/96→; für Linkslenker; GG		24.2122-1716.3 010485	Ø 22,2
1.9 TD 75 S	55	03/96→10/01					
FIAT - BRAVO I (182_) 10/95→10/01							
 Hauptbremszylinder							
1.2 16V 80	59 - 60	12/98→10/01		für Linkslenker; GG		24.2122-1716.3 010485	Ø 22,2
1.4	55 - 59	10/95→10/01					
1.6	76	09/00→10/01					
1.6 16V	66 - 76	10/95→10/01					
1.8 GT	83	10/95→10/01					
1.9 D	48	10/95→10/01					
1.9 JTD	74	09/00→10/01					
1.9 JTD 105	77	12/98→10/01					
2.0 HGT 20V	113	07/98→10/01					
1.9 TD 100 S	74	03/96→10/01		06/96→; für Linkslenker; GG		24.2122-1716.3 010485	Ø 22,2
1.9 TD 75 S	55	03/96→10/01					
FIAT - BRAVO II (198_) 11/06→12/16							
 Hauptbremszylinder							
1.4	66	04/07→12/14		→ 12/07		24.2122-1777.3 011056	Ø 22,2 ohne Bremsflüssigkeitsbehälter
1.4 T-Jet	88 - 110	09/07→12/14					
1.9 D Multijet	66 - 110	04/07→12/14		01/08→		24.4123-1710.3 010866	BOS Ø 23,8 ohne Bremsflüssigkeitsbehälter
1.4 16V	103	04/10→12/14				24.4123-1710.3 010866	BOS Ø 23,8 ohne Bremsflüssigkeitsbehälter
1.4 T-Jet	112	06/11→12/16					
1.6 D Multijet	66 - 88	03/08→12/14					
2.0 D Multijet	120 - 121	09/08→12/14					
1.4 LPG	66	12/08→12/14		11/09→		24.4123-1710.3 010866	BOS Ø 23,8 ohne Bremsflüssigkeitsbehälter
1.6 D Multijet	77	09/07→12/14		03/08→		24.4123-1710.3 010866	BOS Ø 23,8 ohne Bremsflüssigkeitsbehälter
1.9 D Multijet	85	11/06→12/09		04/07→ 12/07		24.2122-1777.3 011056	Ø 22,2 ohne Bremsflüssigkeitsbehälter
				01/08→		24.4123-1710.3 010866	BOS Ø 23,8 ohne Bremsflüssigkeitsbehälter
FIAT - BRAVO Van (198_) 03/08→12/14							
 Hauptbremszylinder							
1.6 JTD Multijet	77	03/08→12/14				24.4123-1710.3 010866	BOS Ø 23,8 ohne Bremsflüssigkeitsbehälter
FIAT - CINQUECENTO (170_) 07/91→07/99							
 Hauptbremszylinder							
0.9 i.e. S	29	07/91→07/99		02/92→ 05/98		24.2119-0833.3 010418	Ø 19
FIAT - COUPE (175_) 11/93→08/00							
 Hauptbremszylinder							
1.8 16V	96	03/96→08/00		07/96→; GG		24.2122-1716.3 010485	Ø 22,2
FIAT - CROMA (194_) 06/05→12/11							
 Hauptbremszylinder							
1.8 16V	103	12/05→12/11		01/06→; für Linkslenker; → 11/10; für Fahrzeuge mit elektronischer Fahrdynamikregelung		24.2125-1732.3 010827	TRW Ø 25,4
1.9 D Multijet	85 - 110	06/05→12/11		für Linkslenker; → 11/10; für Fahrzeuge mit elektronischer Fahrdynamikregelung		24.2125-1732.3 010827	TRW Ø 25,4
2.2 16V	108	06/05→12/10					
2.4 D Multijet	147	06/05→12/11					
1.9 D Multijet	100	12/05→10/07		für Linkslenker; für Fahrzeuge mit elektronischer Fahrdynamikregelung		24.2125-1732.3 010827	TRW Ø 25,4

	kW			 	! #		
FIAT - CROMA Kasten/Kombi (194_) 04/06→12/11							
 Hauptbremszylinder							
1.9 MJTD	88	04/06→12/11		für Linkslenker; → 11/10; für Fahrzeuge mit elektronischer Fahrdynamikregelung	24.2125-1732.3	010827	TRW Ø 25,4
FIAT - DOBLO Bus (263_) 11/09→							
 Hauptbremszylinder							
1.3 D Multijet	66 - 70	02/10→		für Rechtslenker; + ESP	24.4123-1731.3	011094	Ø 23,8 ohne Bremsflüssigkeitsbehälter
1.4	70 - 88	02/10→					
1.4 Natural Power	88	02/10→					
1.6 D Multijet	66 - 88	02/10→					
1.6 D Multijet 2.0 D Multijet	77 99	01/10→ 01/10→		02/10→; für Rechtslenker; + ESP	24.4123-1731.3	011094	Ø 23,8 ohne Bremsflüssigkeitsbehälter
FIAT - DOBLO Cargo (263_) 02/10→							
 Hauptbremszylinder							
1.3 D Multijet	55 - 70	02/10→		für Rechtslenker; + ESP	24.4123-1731.3	011094	Ø 23,8 ohne Bremsflüssigkeitsbehälter
1.4	70 - 88	02/10→					
1.4 Natural Power	88	06/10→					
1.6 D Multijet	66 - 88	02/10→					
2.0 D Multijet	99	02/10→					
FIAT - DOBLO Großraumlimousine (119_, 223_) 03/01→							
 Hauptbremszylinder							
1.2 1.6 1.6 16V 1.9 D	48 68 76 46	03/01→ 09/02→ 10/01→ 03/01→		→ 09/05; - ABS	24.2122-1750.3	010740	Ø 22,2
1.3 D Multijet 1.9 D Multijet	62 88	10/05→ 10/05→		→ 01/10; + ABS			
1.3 JTD	55	05/05→		10/05→ 01/10; + ABS	24.4123-1710.3	010866	BOS Ø 23,8 ohne Bremsflüssigkeitsbehälter
1.3 JTD 16V	51	12/04→05/05		- ABS	24.2122-1750.3	010740	Ø 22,2
1.6 Natural Power	76	09/02→		→ 09/05; - ABS	24.2122-1750.3	010740	Ø 22,2
				→ 01/10; + ABS	24.4123-1710.3	010866	BOS Ø 23,8 ohne Bremsflüssigkeitsbehälter
1.6 Natural Power	68	11/05→07/09		+ ABS	24.4123-1710.3	010866	BOS Ø 23,8 ohne Bremsflüssigkeitsbehälter
1.9 JTD	74 - 77	10/01→		→ 09/05; - ABS	24.2122-1750.3	010740	Ø 22,2
				10/05→ 01/10; + ABS	24.4123-1710.3	010866	BOS Ø 23,8 ohne Bremsflüssigkeitsbehälter
FIAT - DOBLO Kasten/Großraumlimousine (223_) 11/00→							
 Hauptbremszylinder							
1.2 1.2 16V 1.6 16V	48 59 78	03/01→01/04 11/01→01/06 11/01→08/03		- ABS	24.2122-1750.3	010740	Ø 22,2
1.3 D Multijet	55	10/05→01/10		+ ABS			
1.3 JTD 16V 1.6 16V 1.6 Natural Power	51 76 68 - 76	05/04→12/06 10/01→ 09/02→		→ 09/05; - ABS	24.2122-1750.3	010740	Ø 22,2
1.9 D	46	03/01→					
1.3 JTD 16V Multijet 1.9 JTD Multijet	62 88	08/06→ 12/06→		→ 01/10; + ABS	24.4123-1710.3	010866	BOS Ø 23,8 ohne Bremsflüssigkeitsbehälter
1.9 JTD	74 - 77	10/01→		→ 09/05; - ABS	24.2122-1750.3	010740	Ø 22,2
				10/05→ 01/10; + ABS	24.4123-1710.3	010866	BOS Ø 23,8 ohne Bremsflüssigkeitsbehälter
FIAT - DOBLO Pritsche/Fahrgestell (263_) 02/10→							
 Hauptbremszylinder							
1.3 D Multijet	55 - 70	02/10→		für Rechtslenker; + ESP	24.4123-1731.3	011094	Ø 23,8 ohne Bremsflüssigkeitsbehälter
1.4	70 - 88	04/10→					
1.4 Natural Power →	88	06/10→					

	kw					! #		
FIAT - DOBLO Pritsche/Fahrgestell (263_) 02/10→								
 Hauptbremszylinder								
1.6 D Multijet	66 - 88	02/10→			für Rechtslenker; + ESP		24.4123-1731.3 011094	Ø 23,8 ohne Bremsflüssigkeitsbehälter
2.0 D Multijet	99	02/10→						
FIAT - DUCATO Bus (230_) 03/94→05/05								
 Hauptbremszylinder								
1.9 D	50	04/98→04/02			→ 10/01; Nutzlast [kg]: 1.000; + ABS		24.2125-1702.3 010482	Ø 25,4
1.9 D Combinato	51	06/95→04/02			→ 10/01; Nutzlast [kg]: 1.000; - ABS		24.2125-1703.3 010483	Ø 25,4
1.9 TD	66	04/98→04/02			11/01→ 03/02; Nutzlast [kg]: 1.000; + ABS		24.2125-1726.3 010718	Ø 25,4
1.9 D	59	05/98→11/01			→ 10/01; Nutzlast [kg]: 1.000; + ABS		24.2125-1702.3 010482	Ø 25,4
					→ 10/01; Nutzlast [kg]: 1.000; - ABS		24.2125-1703.3 010483	Ø 25,4
					11/01→; Nutzlast [kg]: 1.000; + ABS		24.2125-1726.3 010718	Ø 25,4
1.9 TD Combinato 1.9 TD Panorama/Combinato	59 60	08/94→04/02 03/94→04/02			→ 10/94; Nutzlast [kg]: 1.000; - ABS		24.2122-1715.3 010481	Ø 22,2
					11/94→ 10/01; Nutzlast [kg]: 1.000; + ABS		24.2125-1702.3 010482	Ø 25,4
					11/94→ 10/01; Nutzlast [kg]: 1.000; - ABS		24.2125-1703.3 010483	Ø 25,4
2.0 4x4	80	11/94→11/01			→ 10/01; Nutzlast ab [kg] 1.000 Nutzlast bis [kg] 1.400; + ABS		24.2125-1702.3 010482	Ø 25,4
					→ 10/01; Nutzlast [kg]: 1.800; + ABS		24.2125-1702.3 010482	Ø 25,4
					→ 10/01; Nutzlast ab [kg] 1.000 Nutzlast bis [kg] 1.400; - ABS		24.2125-1703.3 010483	Ø 25,4
					→ 10/01; Nutzlast [kg]: 1.800; - ABS		24.2125-1703.3 010483	Ø 25,4
					11/01→; Nutzlast [kg]: 1.800; + ABS		24.2125-1726.3 010718	Ø 25,4
2.0 JTD	62	10/01→04/02			→ 03/02; Nutzlast [kg]: 1.800; + ABS		24.2125-1726.3 010718	Ø 25,4
					→ 03/02; Nutzlast [kg]: 1.400; + ABS		24.2125-1726.3 010718	Ø 25,4
2.0 Panorama/Combinato	80	03/94→04/02			→ 10/94; Nutzlast ab [kg] 1.000 Nutzlast bis [kg] 1.400; - ABS		24.2122-1715.3 010481	Ø 22,2
					→ 10/01; Nutzlast [kg]: 1.800; + ABS		24.2125-1702.3 010482	Ø 25,4
					11/94→ 10/01; Nutzlast ab [kg] 1.000 Nutzlast bis [kg] 1.400; + ABS		24.2125-1702.3 010482	Ø 25,4
					→ 10/01; Nutzlast [kg]: 1.800; - ABS		24.2125-1703.3 010483	Ø 25,4
					11/94→ 10/01; Nutzlast ab [kg] 1.000 Nutzlast bis [kg] 1.400; - ABS		24.2125-1703.3 010483	Ø 25,4
					11/01→ 03/02; Nutzlast ab [kg] 1.000 Nutzlast bis [kg] 1.400; + ABS		24.2125-1726.3 010718	Ø 25,4
2.5 D Combinato 2.5 TDI Panorama/Combinato	62 80 - 85	08/94→04/02 03/94→04/02			→ 10/94; Nutzlast [kg]: 1.400; - ABS		24.2122-1715.3 010481	Ø 22,2
					11/94→ 10/01; Nutzlast [kg]: 1.400; + ABS		24.2125-1702.3 010482	Ø 25,4
					→ 10/01; Nutzlast [kg]: 1.800; + ABS		24.2125-1702.3 010482	Ø 25,4
					11/94→ 10/01; Nutzlast [kg]: 1.400; - ABS		24.2125-1703.3 010483	Ø 25,4
					→ 10/01; Nutzlast [kg]: 1.800; - ABS		24.2125-1703.3 010483	Ø 25,4
					11/01→ 03/02; Nutzlast [kg]: 1.800; + ABS		24.2125-1726.3 010718	Ø 25,4
2.5 TDI 4x4	85	04/97→04/02			→ 10/01; Nutzlast [kg]: 1.400; + ABS		24.2125-1702.3 010482	Ø 25,4
					→ 10/01; Nutzlast [kg]: 1.400; - ABS		24.2125-1703.3 010483	Ø 25,4
					11/01→ 03/02; Nutzlast [kg]: 1.400; + ABS		24.2125-1726.3 010718	Ø 25,4
2.8 D 2.8 JTD 2.8 JTD 4x4 2.8 TDI 2.8 TDI 4x4	64 94 94 90 90	02/98→04/02 11/00→04/02 11/00→04/02 10/97→04/02 07/99→04/02			→ 10/01; Nutzlast [kg]: 1.400; + ABS		24.2125-1702.3 010482	Ø 25,4
					→ 10/01; Nutzlast [kg]: 1.800; + ABS		24.2125-1702.3 010482	Ø 25,4
					→ 10/01; Nutzlast [kg]: 1.400; - ABS		24.2125-1703.3 010483	Ø 25,4
					→ 10/01; Nutzlast [kg]: 1.800; - ABS		24.2125-1703.3 010483	Ø 25,4
					11/01→ 03/02; Nutzlast [kg]: 1.400; + ABS		24.2125-1726.3 010718	Ø 25,4
					11/01→ 03/02; Nutzlast [kg]: 1.800; + ABS		24.2125-1726.3 010718	Ø 25,4
→								



FIAT - DUCATO Bus (230_) 03/94→05/05

 **Bremskraftregler**

1.9 D	50 - 59	04/98→04/02		→ 10/01; Nutzlast [kg]: 1.000; - ABS	24.6512-1701.3	320153	lastabhängig 2x
1.9 D Combinato	51	06/95→04/02					
1.9 TD	66	04/98→04/02					
1.9 TD Combinato	59	08/94→04/02					
1.9 TD Panorama/Combinato	60	03/94→04/02					
2.0 4x4	80	11/94→11/01		→ 10/01; Nutzlast ab [kg] 1.000 Nutzlast bis [kg] 1.800; - ABS	24.6512-1701.3	320153	lastabhängig 2x
2.0 Panorama/Combinato	80	03/94→04/02					
2.5 D Combinato	62	08/94→04/02		→ 10/01; Nutzlast ab [kg] 1.400 Nutzlast bis [kg] 1.800; - ABS	24.6512-1701.3	320153	lastabhängig 2x
2.5 TDI 4x4	85	04/97→04/02					
2.5 TDI Panorama/Combinato	80 - 85	03/94→04/02					
2.8 D	64	02/98→04/02					
2.8 JTD	94	11/00→04/02					
2.8 JTD 4x4	94	11/00→04/02					
2.8 TDI	90	10/97→04/02					
2.8 TDI 4x4	90	07/99→04/02					

FIAT - DUCATO Bus (244_) 12/01→

 **Hauptbremszylinder**









2.0	81	12/01→07/06		Nutzlast ab [kg] 1.100 Nutzlast bis [kg] 1.800; + ABS	24.2125-1726.3	010718	Ø 25,4
2.0 4x4	81	05/02→07/06					
2.0 Bipower	81	11/02→07/06					
2.0 JTD	62	12/01→07/06					
2.0 LPG	71	11/02→07/06					
2.3 JTD	81 - 93	12/01→12/17					
2.8 JTD	107	04/04→07/06					
2.8 JTD 4x4	94	12/01→07/06					
2.8 TD	90	11/03→07/06					
2.8 TD 4x4	90	11/03→07/06					
2.8 JTD	94	12/01→		→ 07/06; Nutzlast ab [kg] 1.100 Nutzlast bis [kg] 1.800; + ABS	24.2125-1726.3	010718	Ø 25,4

FIAT - DUCATO Bus (250_) 07/06→

 **Hauptbremszylinder**

2 D	74	07/06→05/11		Nutzlast ab [kg] 1.100 Nutzlast bis [kg] 1.500; für Fahrzeuge mit elektronischer Fahrdynamikregelung	24.4125-1701.3	010867	BOS Ø 25,4 ohne Bremsflüssigkeitsbehälter
100 Multijet 2	74	07/06→05/11					
3 D	82 - 96	07/06→					
110 Multijet 2	82 - 83	10/11→		Nutzlast ab [kg] 1.100 Nutzlast bis [kg] 1.500; für Fahrzeuge ohne elektronische Fahrdynamikregelung	24.4125-1702.3	010872	BOS Ø 25,4 ohne Bremsflüssigkeitsbehälter
0 D	85 - 130	07/06→		Nutzlast ab [kg] 1.700 Nutzlast bis [kg] 2.000; für Fahrzeuge mit elektronischer Fahrdynamikregelung; Nutzlast-Code: Nutzlast leicht / Nutzlast schwer	24.4126-1701.3	010868	BOS Ø 27 ohne Bremsflüssigkeitsbehälter
115 Multijet 2	85	06/11→					
120 Multijet 2	88	07/06→					
130 Multijet 2	96	01/07→					
3 D 4x4	96	06/11→		Nutzlast ab [kg] 1.700 Nutzlast bis [kg] 2.000; für Fahrzeuge ohne elektronische Fahrdynamikregelung; Nutzlast-Code: Nutzlast leicht / Nutzlast schwer	24.4126-1702.3	010875	BOS Ø 27 ohne Bremsflüssigkeitsbehälter
140 Natural Power	100	04/09→					
160 Multijet 3	115 - 116	07/06→					
0 D 4x4	116	07/06→					
180 Multijet 3	130	06/11→					
3 D	109	06/11→		Nutzlast ab [kg] 1.700 Nutzlast bis [kg] 2.000; für Fahrzeuge mit elektronischer Fahrdynamikregelung; Nutzlast-Code: Nutzlast leicht / Nutzlast schwer	24.4126-1701.3	010868	BOS Ø 27 ohne Bremsflüssigkeitsbehälter
150 Multijet 2	109	06/11→					
				Nutzlast ab [kg] 1.700 Nutzlast bis [kg] 2.000; für Fahrzeuge ohne elektronische Fahrdynamikregelung; Nutzlast-Code: Nutzlast leicht / Nutzlast schwer	24.4126-1702.3	010875	BOS Ø 27 ohne Bremsflüssigkeitsbehälter
0 D	107	04/10→		06/11→; Nutzlast ab [kg] 1.100 Nutzlast bis [kg] 1.500; für Fahrzeuge mit elektronischer Fahrdynamikregelung	24.4125-1701.3	010867	BOS Ø 25,4 ohne Bremsflüssigkeitsbehälter
150 Multijet 3	107	04/10→					
				Nutzlast ab [kg] 1.100 Nutzlast bis [kg] 1.500; für Fahrzeuge mit elektronischer Fahrdynamikregelung	24.4125-1701.3	010867	BOS Ø 25,4 ohne Bremsflüssigkeitsbehälter
				Nutzlast ab [kg] 1.100 Nutzlast bis [kg] 1.500; für Fahrzeuge ohne elektronische Fahrdynamikregelung	24.4125-1702.3	010872	BOS Ø 25,4 ohne Bremsflüssigkeitsbehälter
				06/11→; Nutzlast ab [kg] 1.100 Nutzlast bis [kg] 1.500; für Fahrzeuge ohne elektronische Fahrdynamikregelung	24.4125-1702.3	010872	BOS Ø 25,4 ohne Bremsflüssigkeitsbehälter
				Nutzlast ab [kg] 1.700 Nutzlast bis [kg] 2.000; für Fahrzeuge mit elektronischer Fahrdynamikregelung; Nutzlast-Code: Nutzlast leicht / Nutzlast schwer	24.4126-1701.3	010868	BOS Ø 27 ohne Bremsflüssigkeitsbehälter

→

	kw			 	! #		
FIAT - DUCATO Bus (250_) 07/06→							
 Hauptbremszylinder							
0 D 150 Multijet 3	107 107	04/10→ 04/10→		Nutzlast ab [kg] 1.700 Nutzlast bis [kg] 2.000; für Fahrzeuge ohne elektronische Fahrdynamikregelung; Nutzlast-Code: Nutzlast leicht / Nutzlast schwer		24.4126-1702.3 010875	BOS Ø 27 ohne Bremsflüssigkeitsbehälter
FIAT - DUCATO Kasten (230_) 03/94→05/05							
 Hauptbremszylinder							
1.9 D 1.9 TD	50 66	04/98→04/02 04/98→04/02		→ 10/01; Nutzlast [kg]: 1.000; + ABS		24.2125-1702.3 010482	Ø 25,4
				→ 10/01; Nutzlast [kg]: 1.000; - ABS		24.2125-1703.3 010483	Ø 25,4
				11/01→ 03/02; Nutzlast [kg]: 1.000; + ABS		24.2125-1726.3 010718	Ø 25,4
1.9 D 1.9 TD 1.9 TD CAT	51 60 59	03/94→04/02 03/94→04/02 08/94→04/02		→ 10/94; Nutzlast [kg]: 1.000; - ABS		24.2122-1715.3 010481	Ø 22,2
				11/94→ 10/01; Nutzlast [kg]: 1.000; + ABS		24.2125-1702.3 010482	Ø 25,4
				11/94→ 10/01; Nutzlast [kg]: 1.000; - ABS		24.2125-1703.3 010483	Ø 25,4
				11/01→ 03/02; Nutzlast [kg]: 1.000; + ABS		24.2125-1726.3 010718	Ø 25,4
1.9 TD	59	05/98→11/01		→ 10/01; Nutzlast [kg]: 1.000; + ABS		24.2125-1702.3 010482	Ø 25,4
				→ 10/01; Nutzlast [kg]: 1.000; - ABS		24.2125-1703.3 010483	Ø 25,4
				11/01→; Nutzlast [kg]: 1.000; + ABS		24.2125-1726.3 010718	Ø 25,4
2.0	80	03/94→04/02		→ 10/94; Nutzlast ab [kg] 1.000 Nutzlast bis [kg] 1.400; - ABS		24.2122-1715.3 010481	Ø 22,2
				→ 10/01; Nutzlast [kg]: 1.800; + ABS		24.2125-1702.3 010482	Ø 25,4
				11/94→ 10/01; Nutzlast ab [kg] 1.000 Nutzlast bis [kg] 1.400; + ABS		24.2125-1702.3 010482	Ø 25,4
				→ 10/01; Nutzlast [kg]: 1.800; - ABS		24.2125-1703.3 010483	Ø 25,4
				11/94→ 10/01; Nutzlast ab [kg] 1.000 Nutzlast bis [kg] 1.400; - ABS		24.2125-1703.3 010483	Ø 25,4
				11/01→ 03/02; Nutzlast ab [kg] 1.000 Nutzlast bis [kg] 1.400; + ABS		24.2125-1726.3 010718	Ø 25,4
				11/01→ 03/02; Nutzlast [kg]: 1.800; + ABS		24.2125-1726.3 010718	Ø 25,4
2.0 4x4	80	11/94→04/02		→ 10/01; Nutzlast ab [kg] 1.000 Nutzlast bis [kg] 1.400; + ABS		24.2125-1702.3 010482	Ø 25,4
				→ 10/01; Nutzlast [kg]: 1.800; + ABS		24.2125-1702.3 010482	Ø 25,4
				→ 10/01; Nutzlast ab [kg] 1.000 Nutzlast bis [kg] 1.400; - ABS		24.2125-1703.3 010483	Ø 25,4
				→ 10/01; Nutzlast [kg]: 1.800; - ABS		24.2125-1703.3 010483	Ø 25,4
				11/01→ 03/02; Nutzlast ab [kg] 1.000 Nutzlast bis [kg] 1.400; + ABS		24.2125-1726.3 010718	Ø 25,4
				11/01→ 03/02; Nutzlast [kg]: 1.800; + ABS		24.2125-1726.3 010718	Ø 25,4
2.0 JTD	62	10/01→04/02		→ 03/02; Nutzlast [kg]: 1.400; + ABS		24.2125-1726.3 010718	Ø 25,4
				→ 03/02; Nutzlast [kg]: 1.800; + ABS		24.2125-1726.3 010718	Ø 25,4
2.5 D 2.5 D 4x4 2.5 TDI	62 62 80 - 85	03/94→04/02 03/94→04/02 03/94→04/02		→ 10/94; Nutzlast [kg]: 1.400; - ABS		24.2122-1715.3 010481	Ø 22,2
				11/94→ 10/01; Nutzlast [kg]: 1.400; + ABS		24.2125-1702.3 010482	Ø 25,4
				→ 10/01; Nutzlast [kg]: 1.800; + ABS		24.2125-1702.3 010482	Ø 25,4
				11/94→ 10/01; Nutzlast [kg]: 1.400; - ABS		24.2125-1703.3 010483	Ø 25,4
				→ 10/01; Nutzlast [kg]: 1.800; - ABS		24.2125-1703.3 010483	Ø 25,4
				11/01→ 03/02; Nutzlast [kg]: 1.400; + ABS		24.2125-1726.3 010718	Ø 25,4
				11/01→ 03/02; Nutzlast [kg]: 1.800; + ABS		24.2125-1726.3 010718	Ø 25,4
2.5 TDI 4x4 2.8 D 2.8 D 4x4 2.8 JTD 2.8 JTD 4x4 2.8 TDI 2.8 TDI 4x4	85 64 64 94 94 90 90	05/98→04/02 05/98→04/02 08/98→04/02 11/00→04/02 11/00→04/02 10/97→04/02 06/99→04/02		→ 10/01; Nutzlast [kg]: 1.400; + ABS		24.2125-1702.3 010482	Ø 25,4
				→ 10/01; Nutzlast [kg]: 1.800; + ABS		24.2125-1702.3 010482	Ø 25,4
				→ 10/01; Nutzlast [kg]: 1.400; - ABS		24.2125-1703.3 010483	Ø 25,4
				→ 10/01; Nutzlast [kg]: 1.800; - ABS		24.2125-1703.3 010483	Ø 25,4
				11/01→ 03/02; Nutzlast [kg]: 1.400; + ABS		24.2125-1726.3 010718	Ø 25,4
				11/01→ 03/02; Nutzlast [kg]: 1.800; + ABS		24.2125-1726.3 010718	Ø 25,4
2.8 TD 4x4	90	05/98→09/01		Nutzlast ab [kg] 1.400 Nutzlast bis [kg] 1.800; + ABS		24.2125-1702.3 010482	Ø 25,4
				Nutzlast ab [kg] 1.400 Nutzlast bis [kg] 1.800; - ABS		24.2125-1703.3 010483	Ø 25,4
→							

FIAT - DUCATO Kasten (230_) 03/94→05/05

Bremskraftregler

1.9 D	50 - 51	03/94→04/02		→ 10/01; Nutzlast [kg]: 1.000; - ABS	24.6512-1701.3	320153	lastabhängig 2x
1.9 TD	59 - 66	03/94→04/02					
1.9 TD CAT	59	08/94→04/02					
2.0	80	03/94→04/02		→ 10/01; Nutzlast ab [kg] 1.000 Nutzlast bis [kg] 1.800; - ABS	24.6512-1701.3	320153	lastabhängig 2x
2.0 4x4	80	11/94→04/02					
2.5 D	62	03/94→04/02		→ 10/01; Nutzlast ab [kg] 1.400 Nutzlast bis [kg] 1.800; - ABS	24.6512-1701.3	320153	lastabhängig 2x
2.5 D 4x4	62	03/94→04/02					
2.5 TDI	80 - 85	03/94→04/02					
2.5 TDI 4x4	85	05/98→04/02					
2.8 D	64	05/98→04/02					
2.8 D 4x4	64	08/98→04/02					
2.8 JTD	94	11/00→04/02					
2.8 JTD 4x4	94	11/00→04/02					
2.8 TDI	90	10/97→04/02					
2.8 TDI 4x4	90	06/99→04/02					
2.8 TD 4x4	90	05/98→09/01		Nutzlast ab [kg] 1.400 Nutzlast bis [kg] 1.800; - ABS	24.6512-1701.3	320153	lastabhängig 2x

FIAT - DUCATO Kasten (244_) 12/01→











Hauptbremszylinder

2.0	81	12/01→07/06		Nutzlast ab [kg] 1.100 Nutzlast bis [kg] 1.800; + ABS	24.2125-1726.3	010718	Ø 25,4
2.0 Bipower	81	11/02→07/06					
2.0 JTD	62	12/01→07/06					
2.0 LPG	71	11/02→07/06					
2.3 JTD	81 - 93	12/01→12/18					
2.8 JTD 4x4	94	12/01→07/06					
2.8 JTD Power	107	04/04→07/06					
2.8 TD	90	12/01→07/06					
2.8 JTD	94	12/01→12/11		→ 07/06; Nutzlast ab [kg] 1.100 Nutzlast bis [kg] 1.800; + ABS	24.2125-1726.3	010718	Ø 25,4











FIAT - DUCATO Kasten (250_) 07/06→











Hauptbremszylinder

2 D	74	07/06→		Nutzlast ab [kg] 1.100 Nutzlast bis [kg] 1.500; für Fahrzeuge mit elektronischer Fahrdynamikregelung	24.4125-1701.3	010867	BOS Ø 25,4 ohne Bremsflüssigkeitsbehälter
100 Multijet 2	74	07/06→					
3 D	83 - 88	07/06→					
110 Multijet 2	83	10/11→		Nutzlast ab [kg] 1.100 Nutzlast bis [kg] 1.500; für Fahrzeuge ohne elektronische Fahrdynamikregelung	24.4125-1702.3	010872	BOS Ø 25,4 ohne Bremsflüssigkeitsbehälter
0 D	85 - 130	07/06→					
115 Multijet 2	85	06/11→		Nutzlast ab [kg] 1.700 Nutzlast bis [kg] 2.000; für Fahrzeuge mit elektronischer Fahrdynamikregelung; Nutzlast-Code: Nutzlast leicht / Nutzlast schwer	24.4126-1701.3	010868	BOS Ø 27 ohne Bremsflüssigkeitsbehälter
120 Multijet 2	88	07/06→					
3 D 4x4	88 - 96	03/10→					
130 Multijet 2	96	06/11→		Nutzlast ab [kg] 1.700 Nutzlast bis [kg] 2.000; für Fahrzeuge ohne elektronische Fahrdynamikregelung; Nutzlast-Code: Nutzlast leicht / Nutzlast schwer	24.4126-1702.3	010875	BOS Ø 27 ohne Bremsflüssigkeitsbehälter
140 Natural Power	100	04/09→					
160 Multijet 3	115 - 116	07/06→					
0 D 4x4	116	07/06→					
180 Multijet 3	130	06/11→					
3 D	109	06/11→		Nutzlast ab [kg] 1.700 Nutzlast bis [kg] 2.000; für Fahrzeuge mit elektronischer Fahrdynamikregelung; Nutzlast-Code: Nutzlast leicht / Nutzlast schwer	24.4126-1701.3	010868	BOS Ø 27 ohne Bremsflüssigkeitsbehälter
150 Multijet 2	109	06/11→		Nutzlast ab [kg] 1.700 Nutzlast bis [kg] 2.000; für Fahrzeuge ohne elektronische Fahrdynamikregelung; Nutzlast-Code: Nutzlast leicht / Nutzlast schwer	24.4126-1702.3	010875	BOS Ø 27 ohne Bremsflüssigkeitsbehälter
0 D	107	04/10→		06/11→; Nutzlast ab [kg] 1.100 Nutzlast bis [kg] 1.500; für Fahrzeuge mit elektronischer Fahrdynamikregelung	24.4125-1701.3	010867	BOS Ø 25,4 ohne Bremsflüssigkeitsbehälter
150 Multijet 3	107	04/10→		Nutzlast ab [kg] 1.100 Nutzlast bis [kg] 1.500; für Fahrzeuge mit elektronischer Fahrdynamikregelung	24.4125-1701.3	010867	BOS Ø 25,4 ohne Bremsflüssigkeitsbehälter
				Nutzlast ab [kg] 1.100 Nutzlast bis [kg] 1.500; für Fahrzeuge ohne elektronische Fahrdynamikregelung	24.4125-1702.3	010872	BOS Ø 25,4 ohne Bremsflüssigkeitsbehälter
				06/11→; Nutzlast ab [kg] 1.100 Nutzlast bis [kg] 1.500; für Fahrzeuge ohne elektronische Fahrdynamikregelung	24.4125-1702.3	010872	BOS Ø 25,4 ohne Bremsflüssigkeitsbehälter
				Nutzlast ab [kg] 1.700 Nutzlast bis [kg] 2.000; für Fahrzeuge mit elektronischer Fahrdynamikregelung; Nutzlast-Code: Nutzlast leicht / Nutzlast schwer	24.4126-1701.3	010868	BOS Ø 27 ohne Bremsflüssigkeitsbehälter
→							













	kw					! #		
FIAT - DUCATO Kasten (250_) 07/06→								
 Hauptbremszylinder								
0 D 150 Multijet 3	107 107	04/10→ 04/10→			Nutzlast ab [kg] 1.700 Nutzlast bis [kg] 2.000; für Fahrzeuge ohne elektronische Fahrdynamikregelung; Nutzlast-Code: Nutzlast leicht / Nutzlast schwer		24.4126-1702.3 010875	BOS Ø 27 ohne Bremsflüssigkeitsbehälter
FIAT - DUCATO Pritsche/Fahrgestell (230_) 03/94→04/02								
 Hauptbremszylinder								
1.9 D 1.9 TD	50 66	04/98→04/02 04/98→04/02			→ 10/01; Nutzlast [kg]: 1.000; + ABS		24.2125-1702.3 010482	Ø 25,4
					→ 10/01; Nutzlast [kg]: 1.000; - ABS		24.2125-1703.3 010483	Ø 25,4
					11/01→ 03/02; Nutzlast [kg]: 1.000; + ABS		24.2125-1726.3 010718	Ø 25,4
1.9 D 1.9 TD 1.9 TD CAT	51 60 59	03/94→04/02 03/94→04/02 08/94→04/02			→ 10/94; Nutzlast [kg]: 1.000; - ABS		24.2122-1715.3 010481	Ø 22,2
					11/94→ 10/01; Nutzlast [kg]: 1.000; + ABS		24.2125-1702.3 010482	Ø 25,4
					11/94→ 10/01; Nutzlast [kg]: 1.000; - ABS		24.2125-1703.3 010483	Ø 25,4
					11/01→ 03/02; Nutzlast [kg]: 1.000; + ABS		24.2125-1726.3 010718	Ø 25,4
1.9 TD	59	05/98→11/01			→ 10/01; Nutzlast [kg]: 1.000; + ABS		24.2125-1702.3 010482	Ø 25,4
					→ 10/01; Nutzlast [kg]: 1.000; - ABS		24.2125-1703.3 010483	Ø 25,4
					11/01→; Nutzlast [kg]: 1.000; + ABS		24.2125-1726.3 010718	Ø 25,4
2.0	80	03/94→04/02			→ 10/94; Nutzlast ab [kg] 1.000 Nutzlast bis [kg] 1.400; - ABS		24.2122-1715.3 010481	Ø 22,2
					→ 10/01; Nutzlast [kg]: 1.800; + ABS		24.2125-1702.3 010482	Ø 25,4
					11/94→ 10/01; Nutzlast ab [kg] 1.000 Nutzlast bis [kg] 1.400; + ABS		24.2125-1702.3 010482	Ø 25,4
					→ 10/01; Nutzlast [kg]: 1.800; - ABS		24.2125-1703.3 010483	Ø 25,4
					11/94→ 10/01; Nutzlast ab [kg] 1.000 Nutzlast bis [kg] 1.400; - ABS		24.2125-1703.3 010483	Ø 25,4
					11/01→ 03/02; Nutzlast ab [kg] 1.000 Nutzlast bis [kg] 1.400; + ABS		24.2125-1726.3 010718	Ø 25,4
					11/01→ 03/02; Nutzlast [kg]: 1.800; + ABS		24.2125-1726.3 010718	Ø 25,4
2.0 JTD	62	07/01→04/02			10/01→ 03/02; Nutzlast [kg]: 1.400; + ABS		24.2125-1726.3 010718	Ø 25,4
					10/01→ 03/02; Nutzlast [kg]: 1.800; + ABS		24.2125-1726.3 010718	Ø 25,4
2.5 D 2.5 D 4x4 2.5 TDI	62 62 80	03/94→04/02 03/94→04/02 03/94→04/02			→ 10/94; Nutzlast [kg]: 1.400; - ABS		24.2122-1715.3 010481	Ø 22,2
					11/94→ 10/01; Nutzlast [kg]: 1.400; + ABS		24.2125-1702.3 010482	Ø 25,4
					→ 10/01; Nutzlast [kg]: 1.800; + ABS		24.2125-1702.3 010482	Ø 25,4
					11/94→ 10/01; Nutzlast [kg]: 1.400; - ABS		24.2125-1703.3 010483	Ø 25,4
					→ 10/01; Nutzlast [kg]: 1.800; - ABS		24.2125-1703.3 010483	Ø 25,4
					11/01→ 03/02; Nutzlast [kg]: 1.800; + ABS		24.2125-1726.3 010718	Ø 25,4
					11/01→ 03/02; Nutzlast [kg]: 1.400; + ABS		24.2125-1726.3 010718	Ø 25,4
2.5 TDI 4x4 2.8 D 2.8 JTD 2.8 JTD 4x4 2.8 TDI	85 64 94 94 90	06/98→04/02 02/98→04/02 11/00→04/02 10/01→04/02 12/98→04/02			→ 10/01; Nutzlast [kg]: 1.400; + ABS		24.2125-1702.3 010482	Ø 25,4
					→ 10/01; Nutzlast [kg]: 1.800; + ABS		24.2125-1702.3 010482	Ø 25,4
					→ 10/01; Nutzlast [kg]: 1.400; - ABS		24.2125-1703.3 010483	Ø 25,4
					→ 10/01; Nutzlast [kg]: 1.800; - ABS		24.2125-1703.3 010483	Ø 25,4
					11/01→ 03/02; Nutzlast [kg]: 1.400; + ABS		24.2125-1726.3 010718	Ø 25,4
					11/01→ 03/02; Nutzlast [kg]: 1.800; + ABS		24.2125-1726.3 010718	Ø 25,4
2.8 iDTD 4x4	90	05/98→09/01			Nutzlast ab [kg] 1.400 Nutzlast bis [kg] 1.800; + ABS		24.2125-1702.3 010482	Ø 25,4
					Nutzlast ab [kg] 1.400 Nutzlast bis [kg] 1.800; - ABS		24.2125-1703.3 010483	Ø 25,4
2.8 TD 4x4	64	05/98→11/01			→ 09/01; Nutzlast ab [kg] 1.400 Nutzlast bis [kg] 1.800; + ABS		24.2125-1702.3 010482	Ø 25,4
					→ 09/01; Nutzlast ab [kg] 1.400 Nutzlast bis [kg] 1.800; - ABS		24.2125-1703.3 010483	Ø 25,4
 Bremskraftregler								
1.9 D 1.9 TD 1.9 TD CAT →	50 - 51 59 - 66 59	03/94→04/02 03/94→04/02 08/94→04/02			→ 10/01; Nutzlast [kg]: 1.000; - ABS		24.6512-1701.3 320153	lastabhängig 2x





























	kw					! #		
FIAT - DUCATO Pritsche/Fahrgestell (230_) 03/94→04/02								
 Bremskraftregler								
2.0	80	03/94→04/02			→ 10/01; Nutzlast ab [kg] 1.000 Nutzlast bis [kg] 1.800; - ABS		24.6512-1701.3 320153	lastabhängig 2x
2.5 D	62	03/94→04/02			→ 10/01; Nutzlast ab [kg] 1.400 Nutzlast bis [kg] 1.800; - ABS		24.6512-1701.3 320153	lastabhängig 2x
2.5 D 4x4	62	03/94→04/02						
2.5 TDI	80	03/94→04/02						
2.5 TDI 4x4	85	06/98→04/02						
2.8 D	64	02/98→04/02						
2.8 JTD	94	11/00→04/02						
2.8 JTD 4x4	94	10/01→04/02						
2.8 TDI	90	12/98→04/02						
2.8 iDTD 4x4	90	05/98→09/01			Nutzlast ab [kg] 1.400 Nutzlast bis [kg] 1.800; - ABS		24.6512-1701.3 320153	lastabhängig 2x
2.8 TD 4x4	64	05/98→11/01			→ 09/01; Nutzlast ab [kg] 1.400 Nutzlast bis [kg] 1.800; - ABS		24.6512-1701.3 320153	lastabhängig 2x
FIAT - DUCATO Pritsche/Fahrgestell (244_) 12/01→								
 Hauptbremszylinder								
2.0	81	04/02→07/06			Nutzlast ab [kg] 1.100 Nutzlast bis [kg] 1.800; + ABS		24.2125-1726.3 010718	Ø 25,4
2.0 JTD	62	12/01→07/06						
2.3 JTD	81	12/01→07/06						
2.8 JTD	90 -	12/01→07/06						
	94							
2.8 JTD 4x4	94	12/01→07/06						
2.8 JTD Power	107	04/04→07/06						
FIAT - DUCATO Pritsche/Fahrgestell (250_) 07/06→								
 Hauptbremszylinder								
2 D	74	07/06→			Nutzlast ab [kg] 1.100 Nutzlast bis [kg] 1.500; für Fahrzeuge mit elektronischer Fahrdynamikregelung		24.4125-1701.3 010867	BOS Ø 25,4 ohne Bremsflüssigkeitsbehälter
100 Multijet 2	74	07/06→						
3 D	82 -	07/06→			Nutzlast ab [kg] 1.100 Nutzlast bis [kg] 1.500; für Fahrzeuge ohne elektronische Fahrdynamikregelung		24.4125-1702.3 010872	BOS Ø 25,4 ohne Bremsflüssigkeitsbehälter
110 Multijet 2	88							
	82 -	08/06→			Nutzlast ab [kg] 1.700 Nutzlast bis [kg] 2.000; für Fahrzeuge mit elektronischer Fahrdynamikregelung; Nutzlast-Code: Nutzlast leicht / Nutzlast schwer		24.4126-1701.3 010868	BOS Ø 27 ohne Bremsflüssigkeitsbehälter
0 D	83							
	85 -	07/06→			Nutzlast ab [kg] 1.700 Nutzlast bis [kg] 2.000; für Fahrzeuge ohne elektronische Fahrdynamikregelung; Nutzlast-Code: Nutzlast leicht / Nutzlast schwer		24.4126-1702.3 010875	BOS Ø 27 ohne Bremsflüssigkeitsbehälter
115 Multijet 2	130							
120 Multijet 2	85	06/11→			Nutzlast ab [kg] 1.700 Nutzlast bis [kg] 2.000; für Fahrzeuge ohne elektronische Fahrdynamikregelung; Nutzlast-Code: Nutzlast leicht / Nutzlast schwer		24.4126-1702.3 010875	BOS Ø 27 ohne Bremsflüssigkeitsbehälter
3 D 4x4	88	07/06→						
140 Natural Power	88	03/10→			Nutzlast ab [kg] 1.700 Nutzlast bis [kg] 2.000; für Fahrzeuge ohne elektronische Fahrdynamikregelung; Nutzlast-Code: Nutzlast leicht / Nutzlast schwer		24.4126-1702.3 010875	BOS Ø 27 ohne Bremsflüssigkeitsbehälter
160 Multijet 3	100	04/09→						
	115 -	07/06→			Nutzlast ab [kg] 1.100 Nutzlast bis [kg] 1.500; für Fahrzeuge mit elektronischer Fahrdynamikregelung		24.4125-1701.3 010867	BOS Ø 25,4 ohne Bremsflüssigkeitsbehälter
180 Multijet 3	116							
	130	06/11→			Nutzlast ab [kg] 1.100 Nutzlast bis [kg] 1.500; für Fahrzeuge ohne elektronische Fahrdynamikregelung		24.4125-1702.3 010872	BOS Ø 25,4 ohne Bremsflüssigkeitsbehälter
130 Multijet 2	96	08/06→						
3 D	96	08/06→			Nutzlast ab [kg] 1.700 Nutzlast bis [kg] 2.000; für Fahrzeuge mit elektronischer Fahrdynamikregelung; Nutzlast-Code: Nutzlast leicht / Nutzlast schwer		24.4125-1701.3 010867	BOS Ø 25,4 ohne Bremsflüssigkeitsbehälter
	96							
	01/07→;				Nutzlast ab [kg] 1.100 Nutzlast bis [kg] 1.500; für Fahrzeuge ohne elektronische Fahrdynamikregelung		24.4125-1702.3 010872	BOS Ø 25,4 ohne Bremsflüssigkeitsbehälter
	01/07→;				Nutzlast ab [kg] 1.700 Nutzlast bis [kg] 2.000; für Fahrzeuge mit elektronischer Fahrdynamikregelung; Nutzlast-Code: Nutzlast leicht / Nutzlast schwer		24.4126-1701.3 010868	BOS Ø 27 ohne Bremsflüssigkeitsbehälter
	01/07→;				Nutzlast ab [kg] 1.700 Nutzlast bis [kg] 2.000; für Fahrzeuge ohne elektronische Fahrdynamikregelung; Nutzlast-Code: Nutzlast leicht / Nutzlast schwer		24.4126-1702.3 010875	BOS Ø 27 ohne Bremsflüssigkeitsbehälter
3 D	109	06/11→			Nutzlast ab [kg] 1.700 Nutzlast bis [kg] 2.000; für Fahrzeuge mit elektronischer Fahrdynamikregelung; Nutzlast-Code: Nutzlast leicht / Nutzlast schwer		24.4126-1701.3 010868	BOS Ø 27 ohne Bremsflüssigkeitsbehälter
150 Multijet 2	109	06/11→						
					Nutzlast ab [kg] 1.700 Nutzlast bis [kg] 2.000; für Fahrzeuge ohne elektronische Fahrdynamikregelung; Nutzlast-Code: Nutzlast leicht / Nutzlast schwer		24.4126-1702.3 010875	BOS Ø 27 ohne Bremsflüssigkeitsbehälter
0 D	107	04/10→			Nutzlast ab [kg] 1.100 Nutzlast bis [kg] 1.500; für Fahrzeuge mit elektronischer Fahrdynamikregelung		24.4125-1701.3 010867	BOS Ø 25,4 ohne Bremsflüssigkeitsbehälter
150 Multijet 3	107	04/10→						
					Nutzlast ab [kg] 1.100 Nutzlast bis [kg] 1.500; für Fahrzeuge mit elektronischer Fahrdynamikregelung		24.4125-1701.3 010867	BOS Ø 25,4 ohne Bremsflüssigkeitsbehälter
					Nutzlast ab [kg] 1.100 Nutzlast bis [kg] 1.500; für Fahrzeuge ohne elektronische Fahrdynamikregelung		24.4125-1702.3 010872	BOS Ø 25,4 ohne Bremsflüssigkeitsbehälter
					06/11→; Nutzlast ab [kg] 1.100 Nutzlast bis [kg] 1.500; für Fahrzeuge ohne elektronische Fahrdynamikregelung		24.4125-1702.3 010872	BOS Ø 25,4 ohne Bremsflüssigkeitsbehälter
→								



















	kw					! #		
FIAT - DUCATO Pritsche/Fahrgestell (250_) 07/06→								
 Hauptbremszylinder								
0 D 150 Multijet 3	107 107	04/10→ 04/10→		Nutzlast ab [kg] 1.700 Nutzlast bis [kg] 2.000; für Fahrzeuge mit elektronischer Fahrdynamikregelung; Nutzlast-Code: Nutzlast leicht / Nutzlast schwer			24.4126-1701.3 010868	BOS Ø 27 ohne Bremsflüssigkeitsbehälter
				Nutzlast ab [kg] 1.700 Nutzlast bis [kg] 2.000; für Fahrzeuge ohne elektronische Fahrdynamikregelung; Nutzlast-Code: Nutzlast leicht / Nutzlast schwer			24.4126-1702.3 010875	BOS Ø 27 ohne Bremsflüssigkeitsbehälter
FIAT - FIORINO Kasten/Großraumlimousine (146_) 01/88→								
 Hauptbremszylinder								
1.7 TD	46	11/96→05/00		- ABS			24.2122-1781.3 011059	Ø 22,2 ohne Bremsflüssigkeitsbehälter
60 1.7 D	44	05/88→05/00		09/88→ 08/93			24.2120-0802.3 010363	ATE Ø 20,6
				09/93→; - ABS			24.2122-1781.3 011059	Ø 22,2 ohne Bremsflüssigkeitsbehälter
65 1.7 TD 70 i.e. 1.4 75 i.e. 1.6	46 49 55	01/97→05/01 05/94→05/01 10/93→05/01		→ 03/01; - ABS			24.2122-1781.3 011059	Ø 22,2 ohne Bremsflüssigkeitsbehälter
FIAT - FIORINO Pick up (146_) 01/88→05/01								
 Hauptbremszylinder								
1.4 1.6 1.7 TD	49 55 46	05/94→05/01 01/94→05/01 01/97→05/01		→ 03/01; - ABS			24.2122-1781.3 011059	Ø 22,2 ohne Bremsflüssigkeitsbehälter
1.7 D	42	10/93→10/99		- ABS			24.2122-1781.3 011059	Ø 22,2 ohne Bremsflüssigkeitsbehälter
1.7 D	44	05/88→10/99		09/93→; - ABS			24.2122-1781.3 011059	Ø 22,2 ohne Bremsflüssigkeitsbehälter
FIAT - GRANDE PUNTO (199_) 06/05→								
 Hauptbremszylinder								
1.2 1.3 D Multijet	48 51 - 62	10/05→ 07/08→		→ 08/10; für Fahrzeuge mit elektronischer Fahrdynamikregelung			24.4122-1709.3 010871	BOS Ø 22,2 ohne Bremsflüssigkeitsbehälter
1.4 16V 1.4 LPG 1.4 Natural Power 1.4 T-Jet 1.6 D Multijet 1.9 D Multijet	70 57 57 88 88 88	10/05→08/11 12/08→ 07/08→ 09/07→ 07/08→ 10/05→		09/10→ 01/11			24.4122-1709.3 010871	BOS Ø 22,2 ohne Bremsflüssigkeitsbehälter
1.2	50 - 51	06/09→		→ 01/11			24.4122-1709.3 010871	BOS Ø 22,2 ohne Bremsflüssigkeitsbehälter
1.2 LPG	51	06/08→12/12		09/10→ 01/11			24.4122-1709.3 010871	BOS Ø 22,2 ohne Bremsflüssigkeitsbehälter
1.3 D Multijet	55	10/05→06/13		04/08→ 08/10; für Fahrzeuge mit elektronischer Fahrdynamikregelung			24.4122-1709.3 010871	BOS Ø 22,2 ohne Bremsflüssigkeitsbehälter
				09/10→ 01/11			24.4122-1709.3 010871	BOS Ø 22,2 ohne Bremsflüssigkeitsbehälter
1.3 D Multijet	56	06/09→07/14		10/09→; für Linkslenker			24.4122-1709.3 010871	BOS Ø 22,2 ohne Bremsflüssigkeitsbehälter
				→ 08/10; für Fahrzeuge mit elektronischer Fahrdynamikregelung			24.4122-1709.3 010871	BOS Ø 22,2 ohne Bremsflüssigkeitsbehälter
				09/10→ 01/11			24.4122-1709.3 010871	BOS Ø 22,2 ohne Bremsflüssigkeitsbehälter
1.3 D Multijet	66	10/05→12/10		→ 08/10; für Fahrzeuge mit elektronischer Fahrdynamikregelung			24.4122-1709.3 010871	BOS Ø 22,2 ohne Bremsflüssigkeitsbehälter
				09/10→			24.4122-1709.3 010871	BOS Ø 22,2 ohne Bremsflüssigkeitsbehälter
1.4	57	06/05→12/15		→ 08/10; für Fahrzeuge mit elektronischer Fahrdynamikregelung			24.4122-1709.3 010871	BOS Ø 22,2 ohne Bremsflüssigkeitsbehälter
1.4 1.4 16V 1.9 D Multijet	55 66 85	10/05→07/07 06/09→07/14 06/06→12/09		für Fahrzeuge mit elektronischer Fahrdynamikregelung			24.4122-1709.3 010871	BOS Ø 22,2 ohne Bremsflüssigkeitsbehälter
1.6	85	02/11→		für Fahrzeuge mit elektronischer Fahrdynamikregelung			24.4122-1709.3 010871	BOS Ø 22,2 ohne Bremsflüssigkeitsbehälter
							24.4122-1709.3 010871	BOS Ø 22,2 ohne Bremsflüssigkeitsbehälter
1.9 D Multijet	96	10/05→		02/06→ 08/10; für Fahrzeuge mit elektronischer Fahrdynamikregelung			24.4122-1709.3 010871	BOS Ø 22,2 ohne Bremsflüssigkeitsbehälter
				09/10→ 01/11			24.4122-1709.3 010871	BOS Ø 22,2 ohne Bremsflüssigkeitsbehälter



































	kw					! #		
FIAT - GRANDE PUNTO Van (199_) 10/05→06/13								
 Hauptbremszylinder								
1.3 JTD Multijet 1.4 LPG 1.4 Natural Power	55 57 57	02/06→06/13 03/09→12/12 03/09→12/12		→ 08/10; für Fahrzeuge mit elektronischer Fahrdynamikregelung		24.4122-1709.3	010871	BOS Ø 22,2 ohne Bremsflüssigkeitsbehälter
				09/10→ 01/11		24.4122-1709.3	010871	BOS Ø 22,2 ohne Bremsflüssigkeitsbehälter
1.3 JTD Multijet	66	02/06→08/10		für Fahrzeuge mit elektronischer Fahrdynamikregelung		24.4122-1709.3	010871	BOS Ø 22,2 ohne Bremsflüssigkeitsbehälter
1.4	57	02/06→06/13		→ 08/10; für Fahrzeuge mit elektronischer Fahrdynamikregelung		24.4122-1709.3	010871	BOS Ø 22,2 ohne Bremsflüssigkeitsbehälter
FIAT - IDEA (350_) 12/03→								
 Hauptbremszylinder								
1.2 16V 1.9 JTD	59 74	01/04→ 01/04→		→ 11/06; für Fahrzeuge ohne elektronische Fahrdynamikregelung		24.2123-1763.3	010842	Ø 23,8
				→ 02/08		24.4123-1708.3	010859	BOS Ø 23,8
1.3 D Multijet 1.4 16V	51 70	01/04→ 01/04→		→ 11/06; für Fahrzeuge ohne elektronische Fahrdynamikregelung		24.2123-1763.3	010842	Ø 23,8
				12/06→ 02/08		24.4123-1708.3	010859	BOS Ø 23,8
1.3 D Multijet	66	10/05→		11/05→ 11/06; für Fahrzeuge ohne elektronische Fahrdynamikregelung		24.2123-1763.3	010842	Ø 23,8
				12/06→ 02/08		24.4123-1708.3	010859	BOS Ø 23,8
1.3 D Multijet 1.4 LPG 1.6 D Multijet	70 57 88	05/08→12/12 03/09→ 05/08→		→ 09/10		24.4123-1708.3	010859	BOS Ø 23,8
				10/10→ 07/12		24.4123-1708.3	010859	BOS Ø 23,8
1.4	57	10/05→		11/05→ 11/06; für Fahrzeuge ohne elektronische Fahrdynamikregelung		24.2123-1763.3	010842	Ø 23,8
				11/05→ 02/08		24.4123-1708.3	010859	BOS Ø 23,8
1.4	66	12/03→		01/04→ 11/06; für Fahrzeuge ohne elektronische Fahrdynamikregelung		24.2123-1763.3	010842	Ø 23,8
				12/06→ 02/08		24.4123-1708.3	010859	BOS Ø 23,8
1.8	81	01/08→07/10				24.4123-1708.3	010859	BOS Ø 23,8
FIAT - IDEA Van (350_) 12/03→								
 Hauptbremszylinder								
1.4 JTD Multijet	70 51 - 66	10/04→12/12 10/04→12/11		für Fahrzeuge ohne elektronische Fahrdynamikregelung; → 11/06		24.2123-1763.3	010842	Ø 23,8
				12/06→		24.4123-1708.3	010859	BOS Ø 23,8
MJTD	74	10/04→12/10		für Fahrzeuge ohne elektronische Fahrdynamikregelung; → 11/06		24.2123-1763.3	010842	Ø 23,8
				→ 12/06		24.4123-1708.3	010859	BOS Ø 23,8
FIAT - LINEA (323_, 110_) 10/06→								
 Hauptbremszylinder								
1.3 D Multijet 1.3 JTD Multijet 1.4	66 63 57	06/07→ 10/06→ 06/07→		07/07→ 05/11; für Fahrzeuge mit elektronischer Fahrdynamikregelung		24.4122-1709.3	010871	BOS Ø 22,2 ohne Bremsflüssigkeitsbehälter
1.3 D Multijet 1.4 1.4 T-Jet	70 66 84 - 88	09/09→ 12/08→ 05/07→		→ 05/11; für Fahrzeuge mit elektronischer Fahrdynamikregelung		24.4122-1709.3	010871	BOS Ø 22,2 ohne Bremsflüssigkeitsbehälter
1.6 D Multijet 1.6	77 81	06/09→ 10/11→		für Fahrzeuge mit elektronischer Fahrdynamikregelung		24.4122-1709.3	010871	BOS Ø 22,2 ohne Bremsflüssigkeitsbehälter
FIAT - MAREA (185_) 05/96→12/07								
 Hauptbremszylinder								
1.2 16V 1.4 80 12V 1.6	60 59 68 - 78	10/98→05/02 09/96→05/02 03/99→12/07		04/99→; für Linkslenker; GG		24.2122-1716.3	010485	Ø 22,2
				für Linkslenker; GG		24.2122-1716.3	010485	Ø 22,2
1.6 100 16V 1.6 100 16V Bipower 1.6 16V 1.6 SX 1.8 115 16V 1.9 JTD 105 1.9 JTD 110 1.9 TD 100 1.9 TD 75 2.0 150 20V 2.0 155 20V 2.4 JTD 130 →	76 76 75 72 83 77 81 74 55 108 - 110 113 96	09/96→05/02 04/99→05/02 04/97→02/99 09/00→08/02 09/96→05/02 12/98→12/02 09/00→08/02 05/96→12/02 09/96→05/02 09/96→05/02 04/99→01/01 04/99→05/02						















	kW					! #		
FIAT - MAREA (185_) 05/96→12/07								
 Hauptbremszylinder								
2.4 TD 125	91	09/96→04/99			für Linkslenker; GG		24.2122-1716.3 010485	Ø 22,2
1.9 JTD	79	01/01→12/07			→ 12/02; für Linkslenker; GG		24.2122-1716.3 010485	Ø 22,2
FIAT - MAREA Weekend (185_) 09/96→12/07								
 Hauptbremszylinder								
1.2 16V	60	10/98→05/02			04/99→; für Linkslenker; GG		24.2122-1716.3 010485	Ø 22,2
1.4 80 12V	59	09/96→05/02			für Linkslenker; GG		24.2122-1716.3 010485	Ø 22,2
1.6	76	09/00→08/02						
1.6 100 16V	76	09/96→05/02						
1.8 115 16V	83	09/96→05/02						
1.9 JTD 105	77	12/98→12/02						
1.9 JTD 110	81	09/00→08/02						
1.9 TD 100	74	09/96→06/03						
1.9 TD 75	55	09/96→05/02						
2.0 150 20V	108 - 110	09/96→05/02						
2.4 JTD 130	96	04/99→05/02						
2.4 TD 125	91	09/96→04/99						
2.0 155 20V	113	04/99→02/03			→ 12/02; für Linkslenker; GG		24.2122-1716.3 010485	Ø 22,2
FIAT - PALIO (178_, 171_) 04/96→								
 Hauptbremszylinder								
1.0	45 - 56	04/96→10/03			- ABS		24.2120-1770.3 011066	ATE Ø 20,6 ohne Bremsflüssigkeitsbehälter
1.1	40	07/97→10/03						
1.2	50	06/99→10/00						
1.4	57 - 63	10/02→						
1.2	44	07/97→08/02			10/97→; - ABS		24.2120-1770.3 011066	ATE Ø 20,6 ohne Bremsflüssigkeitsbehälter
1.7 D	42	04/96→09/02						
1.2	59	03/00→01/12			→ 12/06; - ABS		24.2120-1770.3 011066	ATE Ø 20,6 ohne Bremsflüssigkeitsbehälter
1.5	62	06/04→						
1.7 TD	51 - 53	09/01→						
FIAT - PALIO Weekend (178_, 173_, 373_, 374_, 171_) 04/96→								
 Hauptbremszylinder								
1.2	44 - 54	04/96→10/04			10/97→; - ABS		24.2120-1770.3 011066	ATE Ø 20,6 ohne Bremsflüssigkeitsbehälter
1.7 TD	51	04/96→03/01						
1.2	50 - 59	06/99→10/04			- ABS		24.2120-1770.3 011066	ATE Ø 20,6 ohne Bremsflüssigkeitsbehälter
1.4	51 - 57	07/97→						
1.5	62	02/02→			→ 12/06; - ABS		24.2120-1770.3 011066	ATE Ø 20,6 ohne Bremsflüssigkeitsbehälter
1.9 D	46	03/01→						
1.9 JTD	59	09/01→						
FIAT - PANDA / PANDA CLASSIC (169_) 09/03→								
 Hauptbremszylinder								
1.1	40	09/03→			→ 06/13; - ABS		24.2120-1744.3 010820	Ø 20,6
1.2	44 - 51	09/03→			→ 06/13; für Fahrzeuge mit elektronischer Fahrdynamikregelung		24.2120-1746.3 010835	BOS Ø 20,6
1.2 LPG	44 - 51	04/09→			→ 06/13; + ABS		24.2120-1747.3 010836	BOS Ø 20,6
1.3 D Multijet	51 - 55	09/03→						
1.4 Natural Power	57	09/10→08/13						
1.2 4x4	44	10/04→			→ 06/13; - Diff		24.4120-1702.3 010913	TRW Ø 20,6 ohne Bremsflüssigkeitsbehälter
1.2 4x4	51	04/10→08/13			10/10→ 06/13; - Diff		24.4120-1702.3 010913	TRW Ø 20,6 ohne Bremsflüssigkeitsbehälter
1.2 Natural Power	44	01/07→12/11			- ABS		24.2120-1744.3 010820	Ø 20,6
					für Fahrzeuge mit elektronischer Fahrdynamikregelung		24.2120-1746.3 010835	BOS Ø 20,6
					+ ABS		24.2120-1747.3 010836	BOS Ø 20,6
1.3 D Multijet 4x4	51	10/04→			04/06→ 08/11; - ABS		24.2120-1744.3 010820	Ø 20,6
					04/06→ 08/11; für Fahrzeuge mit elektronischer Fahrdynamikregelung		24.2120-1746.3 010835	BOS Ø 20,6
					04/06→ 08/11; + ABS		24.2120-1747.3 010836	BOS Ø 20,6
					→ 06/13		24.4122-1714.3 010914	TRW Ø 22,2 ohne Bremsflüssigkeitsbehälter
→								













	kw					! #		
FIAT - PANDA / PANDA CLASSIC (169_) 09/03→								
 Hauptbremszylinder								
1.3 D Multijet 4x4	51	10/04→		04/06→ 08/11			24.4122-1714.3 010914	TRW Ø 22,2 ohne Bremsflüssigkeitsbehälter
1.3 JTD Multijet 4x4	55	09/10→08/13		→ 06/13			24.4122-1714.3 010914	TRW Ø 22,2 ohne Bremsflüssigkeitsbehälter
1.4	74	10/06→		11/06→ 06/13; für Fahrzeuge ohne elektronische Fahrdynamikregelung			24.2122-1762.3 010837	Ø 22,2
				11/06→ 06/13; für Fahrzeuge mit elektronischer Fahrdynamikregelung			24.2122-1768.3 010853	Ø 22,2
FIAT - PANDA (141_) 03/80→07/04								
 Hauptbremszylinder								
1100	37	05/91→12/99		für Linkslenker			24.2119-0826.3 010349	Ø 19
1100	40	02/95→09/03		→ 12/02; für Linkslenker			24.2119-0826.3 010349	Ø 19
650	22	01/82→07/04		→ 12/85; 6223908→; für Linkslenker			24.2119-0826.3 010349	Ø 19
				6166304→ 6223907; für Linkslenker			24.2119-0827.3 010350	Ø 19
750	25	01/86→10/03		→ 12/97; für Linkslenker			24.2119-0826.3 010349	Ø 19
 Bremskraftregler								
1100 4x4	40	02/95→07/04		→ 12/02			24.6046-0801.3 320116	4/6 2x
1100 Trekking 4x4	37	10/91→07/04						
650	22	01/82→07/04		6166304→ 6261411			24.6046-0801.3 320116	4/6 2x
FIAT - PANDA (312_, 319_) 02/12→								
 Hauptbremszylinder								
0.9	44 - 63	02/12→					24.4122-1721.3 011079	ATE Ø 22,2 ohne Bremsflüssigkeitsbehälter
0.9 4x4	63 - 66	09/12→						
0.9 Natural Power	51 - 63	07/12→						
1.2	51	02/12→						
1.2 LPG	51	06/12→						
1.3 D Multijet	55 - 70	02/12→						
1.3 D Multijet 4x4	55 - 70	06/12→						
FIAT - PANDA Kasten/Schrägheck (141_) 01/86→02/04								
 Hauptbremszylinder								
1.1	40	09/00→02/04		→ 12/02; für Linkslenker			24.2119-0826.3 010349	Ø 19
1000 i.e	33	08/92→02/04						
 Bremskraftregler								
1.1 4x4	40	09/00→02/04		→ 12/02			24.6046-0801.3 320116	4/6 2x
FIAT - PANDA Kasten/Schrägheck (169_) 03/04→								
 Hauptbremszylinder								
1.1	40	09/04→		→ 06/13; - ABS			24.2120-1744.3 010820	Ø 20,6
1.2	44 - 51	09/04→		→ 06/13; für Fahrzeuge mit elektronischer Fahrdynamikregelung			24.2120-1746.3 010835	BOS Ø 20,6
	44	04/09→		→ 06/13; + ABS			24.2120-1747.3 010836	BOS Ø 20,6
1.2 LPG	44	04/09→						
1.3 D Multijet	51	03/04→						
1.4 Natural Power	57	10/09→						
1.2 4x4	44	09/04→		10/04→ 06/13; - Diff			24.4120-1702.3 010913	TRW Ø 20,6 ohne Bremsflüssigkeitsbehälter
1.2 4x4	51	09/10→		10/10→ 06/13; - Diff			24.4120-1702.3 010913	TRW Ø 20,6 ohne Bremsflüssigkeitsbehälter
1.2 Bipower	44	09/04→12/11		- ABS			24.2120-1744.3 010820	Ø 20,6
1.2 Natural Power	44	01/07→11/09		für Fahrzeuge mit elektronischer Fahrdynamikregelung			24.2120-1746.3 010835	BOS Ø 20,6
				+ ABS			24.2120-1747.3 010836	BOS Ø 20,6
1.2 LPG	51	09/10→		11/10→ 06/13; - ABS			24.2120-1744.3 010820	Ø 20,6
				11/10→ 06/13; für Fahrzeuge mit elektronischer Fahrdynamikregelung			24.2120-1746.3 010835	BOS Ø 20,6
				11/10→ 06/13; + ABS			24.2120-1747.3 010836	BOS Ø 20,6
1.3 D Multijet	55	01/06→		06/06→ 06/13; - ABS			24.2120-1744.3 010820	Ø 20,6
				06/06→ 06/13; für Fahrzeuge mit elektronischer Fahrdynamikregelung			24.2120-1746.3 010835	BOS Ø 20,6
				06/06→ 06/13; + ABS			24.2120-1747.3 010836	BOS Ø 20,6
→								













	kW					! #		
FIAT - PANDA Kasten/Schrägheck (169_) 03/04→								
 Hauptbremszylinder								
1.3 D Multijet 4x4	51	10/04→12/06					24.4122-1714.3 010914	TRW Ø 22,2 ohne Bremsflüssigkeitsbehälter
1.3 D Multijet 4x4	55	01/06→			→ 06/13		24.4122-1714.3 010914	TRW Ø 22,2 ohne Bremsflüssigkeitsbehälter
FIAT - PANDA VAN (312_, 519_) 02/12→								
 Hauptbremszylinder								
0.9	48 - 63	02/12→					24.4122-1721.3 011079	ATE Ø 22,2 ohne Bremsflüssigkeitsbehälter
0.9 4x4	63	09/12→						
0.9 Natural Power	59 - 63	07/12→						
1.2	51	02/12→						
1.2 LPG	51	06/12→						
1.3 D Multijet	55 - 59	02/12→						
1.3 D Multijet 4x4	55 - 59	06/12→						
FIAT - PUNTO (176_) 09/93→09/99								
 Hauptbremszylinder								
1.2 16V	63	04/97→09/99			06/97→		24.2120-1710.3 010468	Ø 20,6
1.4 GT Turbo	96	09/96→07/99			06/97→		24.2120-1710.3 010468	Ø 20,6
					→ 05/97; GG		24.2122-1716.3 010485	Ø 22,2
1.7 TD	46 - 52	01/94→09/99					24.2120-1710.3 010468	Ø 20,6
60 1.2	43	01/94→09/99						
55 1.1	40	09/93→09/99			11/93→		24.2120-1710.3 010468	Ø 20,6
60 1.2	44	09/93→09/99						
75 1.2	54	10/93→09/99						
 Bremskraftregler								
1.2 16V	63	04/97→09/99			06/97→; - ABS; 		24.6513-1705.3 320237	lastabhängig 2x
1.4 GT Turbo	96	09/96→07/99						
55 1.1	40	09/93→09/99			11/93→ 05/97; - ABS; 		24.6513-1705.3 320237	lastabhängig 2x
60 1.2	44	09/93→09/99			06/97→; 		24.6513-1705.3 320237	lastabhängig 2x
60 1.2	43	01/94→09/99			→ 05/97; - ABS; 		24.6513-1705.3 320237	lastabhängig 2x
					06/97→; 		24.6513-1705.3 320237	lastabhängig 2x
75 1.2	54	10/93→09/99			11/93→ 05/97; - ABS; 		24.6513-1705.3 320237	lastabhängig 2x
FIAT - PUNTO (188_) 09/99→07/12								
 Hauptbremszylinder								
1.2 16V 80	59	09/99→04/06			07/03→ 11/05; - ABS		24.2120-1742.3 010776	Ø 20,6
1.2 60	44	09/99→12/10			10/99→ 06/03		24.2120-1742.3 010776	Ø 20,6
					07/03→ 11/05; + ABS		24.2120-1743.3 010777	Ø 20,6
1.2 Bifuel	44	08/07→03/12			10/09→; für Linkslenker		24.4122-1709.3 010871	BOS Ø 22,2 ohne Bremsflüssigkeitsbehälter
1.2 Bipower	44	08/01→05/03					24.2120-1742.3 010776	Ø 20,6
1.2 Natural Power	38 - 44	09/03→03/12			→ 11/05; - ABS		24.2120-1742.3 010776	Ø 20,6
					→ 11/05; + ABS		24.2120-1743.3 010777	Ø 20,6
1.3 JTD 16V	51	06/03→03/12			07/03→ 11/05; für Fahrzeuge mit elektronischer Fahrdynamikregelung		24.2122-1768.3 010853	Ø 22,2
1.9 JTD	74	06/03→03/12						
1.4	70 - 71	09/03→03/12			→ 11/05; für Fahrzeuge mit elektronischer Fahrdynamikregelung		24.2122-1768.3 010853	Ø 22,2
1.4	64	08/10→03/12			für Fahrzeuge mit elektronischer Fahrdynamikregelung		24.2122-1768.3 010853	Ø 22,2
1.8 130 HGT	96	09/99→03/12			10/99→ 06/03		24.2120-1742.3 010776	Ø 20,6
					07/03→ 11/05; für Fahrzeuge mit elektronischer Fahrdynamikregelung		24.2122-1768.3 010853	Ø 22,2
1.9 DS 60	44	09/99→03/12			10/99→ 06/03		24.2120-1742.3 010776	Ø 20,6
1.9 JTD 80	59	09/99→03/12						
1.9 JTD	63	10/01→03/12			→ 06/03		24.2120-1742.3 010776	Ø 20,6
					07/03→ 11/05; für Fahrzeuge mit elektronischer Fahrdynamikregelung		24.2122-1768.3 010853	Ø 22,2
FIAT - PUNTO (199_) 01/12→								
 Hauptbremszylinder								
0.9	74 - 77	07/13→			für Linkslenker		24.4122-1709.3 010871	BOS Ø 22,2 ohne Bremsflüssigkeitsbehälter
→								















	kW			 	! #		
FIAT - PUNTO (199_) 01/12→							
 Hauptbremszylinder							
0.9 Bifuel	63	03/12→		für Linkslenker		24.4122-1709.3 010871	BOS Ø 22,2 ohne Bremsflüssigkeitsbehälter
0.9 Twinair Turbo	63	03/12→					
1.2	49 - 51	03/12→					
1.3 D Multijet	55 - 70	03/12→					
1.3 JTD Multijet	66	05/18→					
1.4	55 - 57	03/12→					
1.4 Bifuel	57	03/12→					
1.4 Multi Air	77	03/12→					
1.4 Natural Power	57	03/12→					
1.4 Turbo Multi Air	99	03/12→					
FIAT - PUNTO Cabriolet (176_) 04/94→06/00							
 Hauptbremszylinder							
60 1.2	43 - 44	04/94→06/00				24.2120-1710.3 010468	Ø 20,6
85 16V 1.2	63	04/97→06/00		06/97→		24.2120-1710.3 010468	Ø 20,6
 Bremskraftregler							
60 1.2	43 - 44	04/94→06/00		→ 05/95; - ABS; 		24.6513-1705.3 320237	lastabhängig 2x
FIAT - PUNTO EVO (199_) 07/08→							
 Hauptbremszylinder							
1.2	48 - 51	10/09→		für Linkslenker		24.4122-1709.3 010871	BOS Ø 22,2 ohne Bremsflüssigkeitsbehälter
1.3 D Multijet	51 - 70	07/08→					
1.4	57	10/09→02/12					
1.4 16V	77 - 99	10/09→02/12					
1.4 LPG	57	06/09→02/12					
1.4 Natural Power	57	10/09→02/12					
1.6 D Multijet	88	10/09→02/12					
1.4	55	07/09→02/12		10/09→; für Linkslenker		24.4122-1709.3 010871	BOS Ø 22,2 ohne Bremsflüssigkeitsbehälter
FIAT - PUNTO EVO Kasten/Schrägheck (199_) 03/09→02/12							
 Hauptbremszylinder							
1.3 D Multijet	55 - 70	03/09→02/12		für Linkslenker		24.4122-1709.3 010871	BOS Ø 22,2 ohne Bremsflüssigkeitsbehälter
1.4	57	03/09→02/12					
FIAT - PUNTO Kasten/Schrägheck (188_) 02/00→12/10							
 Hauptbremszylinder							
1.2 60	44	02/00→10/09		07/03→ 11/05; - ABS		24.2120-1742.3 010776	Ø 20,6
				→ 06/03		24.2120-1742.3 010776	Ø 20,6
				07/03→ 11/05; + ABS		24.2120-1743.3 010777	Ø 20,6
1.2 Natural Power	44	01/03→12/10		→ 11/05; - ABS		24.2120-1742.3 010776	Ø 20,6
				→ 11/05; + ABS		24.2120-1743.3 010777	Ø 20,6
1.3 JTD	51	06/03→10/05		07/03→; für Fahrzeuge mit elektronischer Fahrdynamikregelung		24.2122-1768.3 010853	Ø 22,2
1.9 D 60	44	02/00→10/09		→ 06/03		24.2120-1742.3 010776	Ø 20,6
1.9 JTD	63	02/00→10/09					
FIAT - PUNTO Kasten/Schrägheck (199_) 04/08→							
 Hauptbremszylinder							
0.9 Twinair Turbo	63	03/12→		für Linkslenker		24.4122-1709.3 010871	BOS Ø 22,2 ohne Bremsflüssigkeitsbehälter
1.3 D Multijet	62	03/12→					
1.4	57	03/12→					
1.4 LPG	57	03/12→					
1.3 D Multijet	55	04/08→		→ 08/10; für Fahrzeuge mit elektronischer Fahrdynamikregelung		24.4122-1709.3 010871	BOS Ø 22,2 ohne Bremsflüssigkeitsbehälter
				09/10→ 01/11		24.4122-1709.3 010871	BOS Ø 22,2 ohne Bremsflüssigkeitsbehälter
1.3 D Multijet	70	03/09→		10/09→; für Linkslenker		24.4122-1709.3 010871	BOS Ø 22,2 ohne Bremsflüssigkeitsbehälter
1.4 Natural Power	57	03/09→					













	kw					! #		
FIAT - PUNTO Van (176_) 04/96→02/00								
 Hauptbremszylinder								
1.1 1.7 TD	40 52	04/96→02/00 04/96→02/00		→ 09/99			24.2120-1710.3 010468	Ø 20,6
1.7 D	42	04/96→02/00		→ 05/97			24.2120-1710.3 010468	Ø 20,6
1.7 TD	46	09/96→09/99					24.2120-1710.3 010468	Ø 20,6
 Bremskraftregler								
1.1	40	04/96→02/00		→ 05/97; - ABS; 			24.6513-1705.3 320237	lastabhängig 2x
				06/97→ 09/99; 			24.6513-1705.3 320237	lastabhängig 2x
FIAT - SCUDO Bus (220_) 02/96→12/06								
 Hauptbremszylinder								
1.6 1.9 D 1.9 TD 1.9 TD Eco	58 51 68 66	02/96→12/06 04/98→12/06 02/96→12/06 02/96→12/06		- ABS + ABS			24.2122-1703.3 010422 24.2122-1708.3 010437	Ø 22,2 Ø 22,2
2.0 16V 2.0 JTD	100 69 - 80	06/00→12/06 12/99→12/06						
2.0 JTD 16V	80	05/99→12/06		12/99→; - ABS			24.2122-1703.3 010422	Ø 22,2
				12/99→; + ABS			24.2122-1708.3 010437	Ø 22,2
FIAT - SCUDO Bus (270_, 272_) 01/07→03/16								
 Hauptbremszylinder								
1.6 D Multijet 2.0 D Multijet	66 88 - 120	01/07→03/16 01/07→03/16		für Linkslenker; + ESP für Linkslenker; - ESP			03.2125-0671.3 010965 03.2125-0676.3 011009	ATE Ø 25,4 ATE Ø 25,4 ohne Bremsflüssigkeitsbehälter
2.0 D Multijet 4x4 2.0 D Multijet 4x4	94 88 - 100	04/11→03/16 01/07→03/16		04/11→; für Linkslenker; + ESP 04/11→; für Linkslenker; - ESP			03.2125-0671.3 010965 03.2125-0676.3 011009	ATE Ø 25,4 ATE Ø 25,4 ohne Bremsflüssigkeitsbehälter
FIAT - SCUDO Kasten (220_) 02/96→12/06								
 Hauptbremszylinder								
1.6 1.9 D 1.9 TD	58 51 66 - 68	02/96→12/06 02/96→12/06 02/96→12/06		- ABS + ABS			24.2122-1703.3 010422 24.2122-1708.3 010437	Ø 22,2 Ø 22,2
2.0 JTD 2.0	80 100	12/02→12/06 05/00→12/06						
2.0 JTD 2.0 JTD 16V	69 80	10/99→12/06 05/99→12/06		06/00→; - ABS 06/00→; + ABS 12/99→; - ABS 12/99→; + ABS			24.2122-1703.3 010422 24.2122-1708.3 010437 24.2122-1703.3 010422 24.2122-1708.3 010437	Ø 22,2 Ø 22,2 Ø 22,2 Ø 22,2
FIAT - SCUDO Kasten (270_, 272_) 01/07→03/16								
 Hauptbremszylinder								
1.6 D Multijet 2.0 D Multijet	66 88 - 120	01/07→03/16 01/07→03/16		für Linkslenker; + ESP für Linkslenker; - ESP			03.2125-0671.3 010965 03.2125-0676.3 011009	ATE Ø 25,4 ATE Ø 25,4 ohne Bremsflüssigkeitsbehälter
2.0 D Multijet 4x4 2.0 D Multijet 4x4	94 88 - 100	05/11→03/16 01/07→03/16		04/11→; für Linkslenker; + ESP 04/11→; für Linkslenker; - ESP			03.2125-0671.3 010965 03.2125-0676.3 011009	ATE Ø 25,4 ATE Ø 25,4 ohne Bremsflüssigkeitsbehälter
FIAT - SCUDO Pritsche/Fahrgestell (220_) 09/96→12/06								
 Hauptbremszylinder								
1.6 1.9 D 1.9 TD	58 51 68	09/96→12/06 04/98→12/06 09/96→12/06		- ABS + ABS			24.2122-1703.3 010422 24.2122-1708.3 010437	Ø 22,2 Ø 22,2
2.0 JTD 2.0 JTD 2.0 JTD 16V	80 69 80	12/02→12/06 10/99→12/06 05/99→12/06						
				12/99→; - ABS 12/99→; + ABS			24.2122-1703.3 010422 24.2122-1708.3 010437	Ø 22,2 Ø 22,2
FIAT - SCUDO Pritsche/Fahrgestell (270_, 272_) 01/07→03/16								
 Hauptbremszylinder								
1.6 D Multijet 2.0 D Multijet	66 88 - 120	01/07→03/16 01/07→03/16		für Linkslenker; + ESP für Linkslenker; - ESP			03.2125-0671.3 010965 03.2125-0676.3 011009	ATE Ø 25,4 ATE Ø 25,4 ohne Bremsflüssigkeitsbehälter















	kw					! #		
FIAT - SEDICI (189_) 06/06→10/14								
 Hauptbremszylinder								
1.6 16V	79 - 88	06/06→10/14		für Fahrzeuge ohne elektronische Fahrdynamikregelung		24.4122-1712.3	010899	BOS Ø 22,2 ohne Bremsflüssigkeitsbehälter
1.6 16V 4x4	79 - 88	06/06→10/14		für Fahrzeuge mit elektronischer Fahrdynamikregelung		24.4122-1713.3	010900	BOS Ø 22,2 ohne Bremsflüssigkeitsbehälter
1.9 D Multijet	88	06/06→10/11						
1.9 D Multijet 4x4	88	06/06→10/11						
2.0 D Multijet	99	06/06→10/14						
2.0 D Multijet 4x4	99	06/06→10/14						
FIAT - SEICENTO / 600 (187_) 11/97→01/10								
 Hauptbremszylinder								
0.9	29	11/97→12/08		04/98→ 03/08		24.2119-0833.3	010418	Ø 19
1.1	40	01/98→01/10						
Elektra	30	01/99→01/05		03/00→		24.2119-0833.3	010418	Ø 19
Elettrica	22	03/00→04/04				24.2119-0833.3	010418	Ø 19
FIAT - SEICENTO / 600 Kasten/Schrägheck (287_) 01/98→01/10								
 Hauptbremszylinder								
0.9	29	01/98→01/10		04/98→ 03/08		24.2119-0833.3	010418	Ø 19
1.1	40	01/98→01/10						
FIAT - SIENA (178_, 172_) 04/96→12/16								
 Hauptbremszylinder								
1.3	59	09/01→12/09		→ 12/06; - ABS		24.2120-1770.3	011066	ATE Ø 20,6 ohne Bremsflüssigkeitsbehälter
FIAT - STRADA Pick-up (178_, 278_) 02/98→								
 Hauptbremszylinder								
1.2	44	04/03→		→ 12/11		24.2122-1781.3	011059	Ø 22,2 ohne Bremsflüssigkeitsbehälter
1.2 Trekking	60	11/05→						
1.3 D Multijet	62	05/06→						
1.9 D	46	12/00→						
1.9 JTD	59	04/03→						
1.2	54	06/99→12/06				24.2122-1781.3	011059	Ø 22,2 ohne Bremsflüssigkeitsbehälter
1.7 TD	51	06/99→12/06						
FIAT - TIPO Kombi (356_, 357_) 03/16→								
 Hauptbremszylinder								
1.0	74	11/20→		Automatikgetriebe		24.4122-1734.3	011117	Ø 22,2 ohne Bremsflüssigkeitsbehälter
1.3 D	70	03/16→10/20						
1.4	70 - 88	03/16→10/20						
1.4 LPG	88	05/16→10/20						
1.6	81	07/16→10/20						
1.6 D	84 - 88	03/16→10/20						
1.6 Multijet	96	11/20→						
FIAT - TIPO Schrägheck (356_, 357_) 03/16→								
 Hauptbremszylinder								
1.0	74	11/20→		Automatikgetriebe		24.4122-1734.3	011117	Ø 22,2 ohne Bremsflüssigkeitsbehälter
1.3 D	70	03/16→10/20						
1.4	70 - 88	03/16→10/20						
1.4 LPG	88	05/16→10/20						
1.6 D	84 - 88	03/16→10/20						
1.6 Multijet	96	11/20→						
1.6	81	07/16→10/20				24.4122-1734.3	011117	Ø 22,2 ohne Bremsflüssigkeitsbehälter
FIAT - TIPO Stufenheck (356_, 357_) 10/15→								
 Hauptbremszylinder								
1.0	74	11/20→		Automatikgetriebe		24.4122-1734.3	011117	Ø 22,2 ohne Bremsflüssigkeitsbehälter
1.3 D	70	10/15→10/20						
1.4	70	10/15→10/20						
1.4 LPG	88	05/16→10/20						
1.6 D	84 - 88	10/15→10/20						
1.6 Multijet	96	11/20→						
1.6	81	10/15→10/20				24.4122-1734.3	011117	Ø 22,2 ohne Bremsflüssigkeitsbehälter













	kw			 	! #		
FIAT - ULYSSE (179_) 08/02→06/11							
 Hauptbremszylinder							
2.0 2.0 D Multijet	100 88 - 100	08/02→06/11 05/06→06/11		→ 01/11		03.2122-2163.3 010800	ATE Ø 22,2
2.2 D Multijet 2.2 JTD	125 120	03/08→06/11 03/08→06/11					
2.0 JTD 2.2 JTD	79 - 80 94	08/02→08/06 08/02→08/06				03.2122-2163.3 010800	ATE Ø 22,2
FIAT - ULYSSE (220_) 06/94→08/02							
 Hauptbremszylinder							
1.8 1.9 TD 2.0	73 66 89	05/97→08/02 02/95→08/02 06/94→08/02		→ 04/99; - ABS 05/99→ 07/02; + ABS 05/99→ 07/02; - ABS		24.2123-1707.3 010492 24.2123-1733.3 010657 24.2123-1738.3 010658	Ø 23,8 BOS Ø 23,8 Ø 23,8
1.9 TD	68	05/97→12/99		→ 04/99; - ABS 05/99→; + ABS 05/99→; - ABS		24.2123-1707.3 010492 24.2123-1733.3 010657 24.2123-1738.3 010658	Ø 23,8 BOS Ø 23,8 Ø 23,8
2.0 16V 2.1 TD	97 80	05/98→09/00 03/96→10/99		05/99→		24.2123-1733.3 010657	BOS Ø 23,8
2.0 16V 2.0 JTD 2.0 JTD 16V 2.0 Turbo	100 80 80 108	09/00→08/02 10/99→08/02 05/99→08/02 06/94→08/02		→ 07/02 05/99→ 07/02		24.2123-1733.3 010657 24.2123-1733.3 010657	BOS Ø 23,8 BOS Ø 23,8
FORD - B-MAX (JK) 10/12→							
 Hauptbremszylinder							
1.0 EcoBoost 1.4 1.4 LPG 1.5 TDCi 1.6 TDCi 1.6 Ti	74 - 103 66 64 - 66 55 - 70 70 77	10/12→ 10/12→ 08/13→ 10/12→ 10/12→ 10/12→				24.4120-1710.3 011082	Ø 20,6 ohne Bremsflüssigkeitsbehälter
FORD - B-MAX Van (JK) 08/12→							
 Hauptbremszylinder							
1.0 EcoBoost 1.4 1.4 LPG 1.5 TDCi 1.6 TDCi 1.6 Ti	74 - 92 66 66 55 - 70 70 77	08/12→ 10/12→ 10/12→ 10/12→ 10/12→ 10/12→				24.4120-1710.3 011082	Ø 20,6 ohne Bremsflüssigkeitsbehälter
FORD - C-MAX (DM2) 02/07→09/10							
 Bremskraftverstärker							
1.6 1.6 TDCi	74 66 - 80	02/07→09/10 02/07→09/10		03/07→ 04/07 05/07→; für Fahrzeuge mit Bremsassistent		03.7863-0332.4 300203 03.7863-3932.4 300288	ATE Ø 10" pneumatisch ATE Ø 10" pneumatisch
1.8 1.8 Flexifuel 1.8 TDCi 2.0 2.0 TDCi	90 - 92 92 85 107 98 - 100	02/07→09/10 02/07→09/10 02/07→09/10 02/07→09/10 02/07→09/10 02/07→09/10					
1.6	85	04/07→09/10		→ 04/07 05/07→; für Fahrzeuge mit Bremsassistent		03.7863-0332.4 300203 03.7863-3932.4 300288	ATE Ø 10" pneumatisch ATE Ø 10" pneumatisch
2.0 CNG 2.0 LPG 2.0 TDCi	107 107 81	04/09→09/10 06/08→09/10 02/08→09/10		für Fahrzeuge mit Bremsassistent		03.7863-3932.4 300288	ATE Ø 10" pneumatisch
 Hauptbremszylinder							
1.6 1.6 TDCi	74 66 - 80	02/07→09/10 02/07→09/10		03/07→ 05/07 06/07→ 10/08		03.2123-3103.3 010781 03.2125-0483.3 010783	ATE Ø 23,8 ATE Ø 25,4 ohne Bremsflüssigkeitsbehälter
1.8 1.8 Flexifuel 1.8 TDCi →	90 - 92 92 85	02/07→09/10 02/07→09/10 02/07→09/10		11/08→		03.2125-0661.3 010917	ATE Ø 25,4







	kw			 	! #		
FORD - C-MAX (DM2) 02/07→09/10							
 Hauptbremszylinder							
2.0 2.0 TDCi	107 98 - 100	02/07→09/10 02/07→09/10		03/07→ 05/07 06/07→ 10/08 11/08→		03.2123-3103.3 010781 03.2125-0483.3 010783 03.2125-0661.3 010917	ATE Ø 23,8 ATE Ø 25,4 ohne Bremsflüssigkeitsbehälter ATE Ø 25,4
1.6	85	04/07→09/10		→ 05/07 06/07→ 10/08 11/08→		03.2123-3103.3 010781 03.2125-0483.3 010783 03.2125-0661.3 010917	ATE Ø 23,8 ATE Ø 25,4 ohne Bremsflüssigkeitsbehälter ATE Ø 25,4
2.0 CNG	107	04/09→09/10				03.2125-0661.3 010917	ATE Ø 25,4
2.0 LPG 2.0 TDCi	107 81	06/08→09/10 02/08→09/10		→ 10/08 11/08→		03.2125-0483.3 010783 03.2125-0661.3 010917	ATE Ø 25,4 ohne Bremsflüssigkeitsbehälter ATE Ø 25,4
Hydraulikaggregat, Bremsanlage							
1.6 1.6 TDCi	74 66 - 80	02/07→09/10 02/07→09/10		03/07→		24.9145-0004.2 399008	
1.8 1.8 Flexifuel 1.8 TDCi	90 - 92 92	02/07→09/10 02/07→09/10					
2.0 2.0 TDCi	107 98 - 100	02/07→09/10 02/07→09/10					
1.6 2.0 CNG 2.0 LPG 2.0 TDCi	85 107 107 81	04/07→09/10 04/09→09/10 06/08→09/10 02/08→09/10				24.9145-0004.2 399008	
FORD - C-MAX II (DXA/CB7, DXA/CEU) 04/10→06/19							
 Hauptbremszylinder							
1.0 EcoBoost 1.5 EcoBoost	74 - 92 110 - 134	10/12→06/19 03/15→06/19				03.4155-5451.3 010995	ATE Ø 25,4
1.6 CNG 1.6 EcoBoost	86 110 - 134	01/13→12/14 12/10→06/19					
1.6 Flexifuel 1.6 LPG	88 86 - 88	02/11→06/19 02/12→06/19					
1.6 TDCi 1.6 Ti	70 - 85 63 - 92	12/10→06/19 12/10→06/19					
2.0 TDCi	85 - 125	04/10→06/19					
FORD - C-MAX II Van 10/10→06/19							
 Hauptbremszylinder							
1.0 EcoBoost 1.5 EcoBoost	74 - 92 110 - 134	10/12→06/19 03/15→06/19				03.4155-5451.3 010995	ATE Ø 25,4
1.6 EcoBoost 1.6 TDCi	110 - 134 70 - 85	12/10→06/19 12/10→06/19					
1.6 Ti 2.0 TDCi	77 85 - 125	10/10→06/19 12/10→06/19					
FORD - COUGAR (EC_) 08/98→12/01							
 Hauptbremszylinder							
2.0 16V 2.5 V6 24V	96 125	08/98→12/01 08/98→12/01		09/98→		24.2125-1709.3 010499	Ø 25,4
2.5 ST 200 2.5 V6 24V	151 125	01/00→12/01 06/00→12/01				24.2125-1709.3 010499	Ø 25,4
FORD - ESCORT VI (GAL, AAL, ABL) 01/95→10/02							
 Hauptbremszylinder							
1.4	54	01/95→12/99		08/95→ 02/99; + ABS 02/95→ 02/99; - ABS		03.2123-1581.3 010487 24.2123-1732.3 010625	Ø 23,8 Ø 23,8 ohne Bremsflüssigkeitsbehälter

	kw			 	! #		
FORD - ESCORT VI Cabriolet (ALL) 03/94→08/00							
 Hauptbremszylinder							
1.6 16V XR3i	66	02/95→09/99		08/95→; + ABS		03.2123-1581.3 010487	Ø 23,8
				→ 02/99; - ABS		24.2123-1732.3 010625	Ø 23,8 ohne Bremsflüssigkeitsbehälter
1.8 Turbo D	51	10/96→08/99		+ ABS		03.2123-1581.3 010487	Ø 23,8
				→ 02/99; - ABS		24.2123-1732.3 010625	Ø 23,8 ohne Bremsflüssigkeitsbehälter
FORD - ESCORT VI Express (AVL) 01/95→06/01							
 Hauptbremszylinder							
1.4	54	01/95→08/00		08/95→ 02/99; + ABS		03.2123-1581.3 010487	Ø 23,8
1.8 D	44	01/95→08/00		02/95→ 02/99; - ABS		24.2123-1732.3 010625	Ø 23,8 ohne Bremsflüssigkeitsbehälter
1.8 TD	66	01/95→08/00		08/95→ 07/00; + ABS		03.2123-1581.3 010487	Ø 23,8
				02/95→ 02/99; - ABS		24.2123-1732.3 010625	Ø 23,8 ohne Bremsflüssigkeitsbehälter
1.8 Turbo D	51	12/95→06/01		→ 07/00; + ABS		03.2123-1581.3 010487	Ø 23,8
				→ 02/99; + ABS		03.2123-1581.3 010487	Ø 23,8
				→ 02/99; - ABS		24.2123-1732.3 010625	Ø 23,8 ohne Bremsflüssigkeitsbehälter
FORD - ESCORT VI Stufenheck (GAL, AFL) 01/95→08/02							
 Hauptbremszylinder							
1.3	44	01/95→02/99		08/95→; + ABS		03.2123-1581.3 010487	Ø 23,8
1.4	55	01/95→02/99		02/95→; - ABS		24.2123-1732.3 010625	Ø 23,8 ohne Bremsflüssigkeitsbehälter
1.6 i 16V	66	01/95→02/99					
1.8 16V	85	01/95→02/99					
1.8 TD	66	01/95→02/99					
1.8 Turbo D	51	12/95→02/99		+ ABS		03.2123-1581.3 010487	Ø 23,8
				- ABS		24.2123-1732.3 010625	Ø 23,8 ohne Bremsflüssigkeitsbehälter
FORD - ESCORT VI Turnier (GAL, ANL) 01/95→10/02							
 Hauptbremszylinder							
1.3	44	01/95→01/99		08/95→; + ABS		03.2123-1581.3 010487	Ø 23,8
1.4	55	01/95→02/99		02/95→; - ABS		24.2123-1732.3 010625	Ø 23,8 ohne Bremsflüssigkeitsbehälter
1.6 16V	66	01/95→02/99					
1.8 16V	85	01/95→02/99					
1.8 D	44	01/95→02/99					
1.8 TD	66	01/95→02/99					
1.8 Turbo D	51	12/95→02/99		+ ABS		03.2123-1581.3 010487	Ø 23,8
				- ABS		24.2123-1732.3 010625	Ø 23,8 ohne Bremsflüssigkeitsbehälter
FORD - ESCORT CLASSIC (AAL, ABL) 10/98→07/00							
 Hauptbremszylinder							
1.6 16V	66	10/98→07/00		+ ABS		03.2123-1581.3 010487	Ø 23,8
1.8 TD	66	10/98→07/00		→ 02/99; - ABS		24.2123-1732.3 010625	Ø 23,8 ohne Bremsflüssigkeitsbehälter
FORD - ESCORT CLASSIC Turnier (ANL) 02/99→07/00							
 Hauptbremszylinder							
1.6 16V	66	02/99→07/00		+ ABS		03.2123-1581.3 010487	Ø 23,8
1.8 TD	66	02/99→07/00		→ 02/99; - ABS		24.2123-1732.3 010625	Ø 23,8 ohne Bremsflüssigkeitsbehälter
FORD - FIESTA IV (JA_, JB_) 08/95→06/06							
 Hauptbremszylinder							
1.0 i	38	04/96→09/99		- ABS		24.2122-1775.3 010981	Ø 22,2 ohne Bremsflüssigkeitsbehälter
1.0 i	48	09/99→01/02		02/00→; + ABS		03.2123-2243.3 010748	ATE Ø 23,8
				02/00→; - ABS		24.2122-1588.3 011028	ATE Ø 22,2 ohne Druckregler
				→ 01/00; - ABS		24.2122-1775.3 010981	Ø 22,2 ohne Bremsflüssigkeitsbehälter
1.25 i 16V	55	08/95→01/02		02/00→; + ABS		03.2123-2243.3 010748	ATE Ø 23,8
				02/00→; - ABS		24.2122-1588.3 011028	ATE Ø 22,2 ohne Druckregler
				01/96→ 01/00; Schaltgetriebe; - ABS		24.2122-1775.3 010981	Ø 22,2 ohne Bremsflüssigkeitsbehälter
→							











	kw					! #		
FORD - FIESTA IV (JA_, JB_) 08/95→06/06								
 Hauptbremszylinder								
1.3 i	37 - 44	08/95→01/02		02/00→; + ABS		03.2123-2243.3	010748	ATE Ø 23,8
1.8 D	44	08/95→04/00		01/96→; - ABS		24.2122-1775.3	010981	Ø 22,2 ohne Bremsflüssigkeitsbehälter
1.4 i 16V	66	04/96→01/02		02/00→; + ABS		03.2123-2243.3	010748	ATE Ø 23,8
1.6 16V Sport	76	02/00→01/02		+ ABS		03.2123-2243.3	010748	ATE Ø 23,8
1.8 DI	55	04/00→01/02		+ ABS		03.2123-2243.3	010748	ATE Ø 23,8
				- ABS		24.2122-1775.3	010981	Ø 22,2 ohne Bremsflüssigkeitsbehälter
FORD - FIESTA V (JH_, JD_) 11/01→12/14								
 Bremskraftverstärker								
1.25 16V	51 - 55	05/02→06/08		für Fahrzeuge ohne Bremsassistent		03.7750-8732.4	300199	ATE Ø 9" pneumatisch
1.3 ROCAM	55	01/02→12/04		für Fahrzeuge mit Bremsassistent		03.7853-2102.4	300201	ATE Ø 9" pneumatisch
1.6	72	05/02→06/08						
1.6 TDCi	66	11/04→06/08						
1.3	44 - 51	11/01→06/08		04/02→; für Fahrzeuge ohne Bremsassistent		03.7750-8732.4	300199	ATE Ø 9" pneumatisch
				04/02→; für Fahrzeuge mit Bremsassistent		03.7853-2102.4	300201	ATE Ø 9" pneumatisch
1.4 16V	59	11/01→06/08						
1.4 TDCi	50	11/01→06/08						
1.6 16V	74	11/01→06/08						
 Hauptbremszylinder								
1.25 16V	51 - 55	05/02→06/08		für Linkslenker; - ABS		03.4153-0015.3	011005	ATE Ø 23,8 ohne Bremsflüssigkeitsbehälter
1.3 ROCAM	55	01/02→12/04		für Linkslenker; + ABS		03.4153-5287.4	010953	ATE Ø 23,8 mit Bremsflüssigkeitsbehälter
1.6	72	05/02→06/08						
1.6 TDCi	66	11/04→06/08						
1.3	44 - 51	11/01→06/08		04/02→; für Linkslenker; - ABS		03.4153-0015.3	011005	ATE Ø 23,8 ohne Bremsflüssigkeitsbehälter
				04/02→; für Linkslenker; + ABS		03.4153-5287.4	010953	ATE Ø 23,8 mit Bremsflüssigkeitsbehälter
1.4 16V	59	11/01→06/08						
1.4 TDCi	50	11/01→06/08						
1.6 16V	74	11/01→06/08						
FORD - FIESTA V Van 05/02→12/10								
 Bremskraftverstärker								
1.3	44 - 51	05/02→08/08		für Fahrzeuge ohne Bremsassistent		03.7750-8732.4	300199	ATE Ø 9" pneumatisch
				für Fahrzeuge mit Bremsassistent		03.7853-2102.4	300201	ATE Ø 9" pneumatisch
1.4	59	05/02→09/05						
1.4 TDCi	50	10/03→12/10		→ 08/08; für Fahrzeuge ohne Bremsassistent		03.7750-8732.4	300199	ATE Ø 9" pneumatisch
1.6 TDCi	66	04/07→09/09		→ 08/08; für Fahrzeuge mit Bremsassistent		03.7853-2102.4	300201	ATE Ø 9" pneumatisch
 Hauptbremszylinder								
1.3	44 - 51	05/02→08/08		für Linkslenker; - ABS		03.4153-0015.3	011005	ATE Ø 23,8 ohne Bremsflüssigkeitsbehälter
				für Linkslenker; + ABS		03.4153-5287.4	010953	ATE Ø 23,8 mit Bremsflüssigkeitsbehälter
1.4	59	05/02→09/05						
1.4 TDCi	50	10/03→12/10		→ 08/08; für Linkslenker; - ABS		03.4153-0015.3	011005	ATE Ø 23,8 ohne Bremsflüssigkeitsbehälter
1.6 TDCi	66	04/07→09/09		→ 08/08; für Linkslenker; + ABS		03.4153-5287.4	010953	ATE Ø 23,8 mit Bremsflüssigkeitsbehälter
FORD - FIESTA VI (CB1, CCN) 06/08→								
 Hauptbremszylinder								
1.0	48 - 59	10/12→04/17		+ ABS		24.4120-1710.3	011082	Ø 20,6 ohne Bremsflüssigkeitsbehälter
				- ABS		24.4120-1711.3	011093	Ø 20,6 ohne Bremsflüssigkeitsbehälter
1.0 EcoBoost	74	01/13→						
1.0 Sport	103	05/14→04/17						
1.4	71	10/08→09/12						
1.4 TDCi	50 - 51	08/08→09/12						
1.5 TDCi	70	05/15→04/17						
1.6	62 - 90	10/10→						
1.6 TDCi	70	02/10→12/15						
1.6 Ti	99	12/10→						
1.0 EcoBoost	92 - 55	09/12→		+ ABS		24.4120-1710.3	011082	Ø 20,6 ohne Bremsflüssigkeitsbehälter
				10/12→; - ABS		24.4120-1711.3	011093	Ø 20,6 ohne Bremsflüssigkeitsbehälter
1.5 TDCi	55	09/12→04/17						
1.6 Ti	77	09/12→						
→								











	kW			 	! #		
FORD - FIESTA VI (CB1, CCN) 06/08→							
 Hauptbremszylinder							
1.25	44	06/08→04/17		+ ABS		24.4120-1710.3 011082	Ø 20,6 ohne Bremsflüssigkeitsbehälter
1.6 TDCi	55 - 66	06/08→12/12		09/08→; - ABS		24.4120-1711.3 011093	Ø 20,6 ohne Bremsflüssigkeitsbehälter
1.6 Ti	88	06/08→09/12					
1.4 LPG	68 - 71	01/09→04/17		+ ABS		24.4120-1710.3 011082	Ø 20,6 ohne Bremsflüssigkeitsbehälter
				06/09→; - ABS		24.4120-1711.3 011093	Ø 20,6 ohne Bremsflüssigkeitsbehälter
1.6 ST	134	03/13→04/17				24.4122-1733.3 011116	Ø 22,2 ohne Bremsflüssigkeitsbehälter
1.6 ST200	147	04/16→04/17					
FORD - FIESTA VI Van 08/08→							
 Hauptbremszylinder							
1.0	48 - 59	10/12→		+ ABS		24.4120-1710.3 011082	Ø 20,6 ohne Bremsflüssigkeitsbehälter
1.0 EcoBoost	74 - 103	01/13→		- ABS		24.4120-1711.3 011093	Ø 20,6 ohne Bremsflüssigkeitsbehälter
1.25	44 - 60	08/08→					
1.4	71	10/08→12/12					
1.4 TDCi	50 - 51	01/09→					
1.5 TDCi	55 - 70	10/12→					
1.6 TDCi	66 - 70	01/09→					
1.6 Ti-VCT	88	10/08→12/12					
1.0 EcoBoost	92	09/12→		+ ABS		24.4120-1710.3 011082	Ø 20,6 ohne Bremsflüssigkeitsbehälter
				10/12→; - ABS		24.4120-1711.3 011093	Ø 20,6 ohne Bremsflüssigkeitsbehälter
1.6 ST	134	03/13→				24.4122-1733.3 011116	Ø 22,2 ohne Bremsflüssigkeitsbehälter
FORD - FIESTA Kasten/Großraumlimousine (J5_, J3_) 02/96→							
 Hauptbremszylinder							
1.3	44	02/96→08/03		02/00→ 03/02; - ABS		24.2122-1588.3 011028	ATE Ø 22,2 ohne Druckregler
1.8 D	44	02/96→04/02		→ 01/00; - ABS		24.2123-1737.3 010654	Ø 23,8
1.8 DI	55	09/00→08/03		→ 03/02; + ABS		03.2123-2243.3 010748	ATE Ø 23,8
				→ 03/02; - ABS		24.2122-1775.3 010981	Ø 22,2 ohne Bremsflüssigkeitsbehälter
FORD - FIESTA Kasten/Schrägheck (JV_) 05/98→08/03							
 Hauptbremszylinder							
D 1.8	44	05/98→04/02		02/00→ 03/02; - ABS		24.2122-1588.3 011028	ATE Ø 22,2 ohne Druckregler
				→ 01/00; - ABS		24.2123-1737.3 010654	Ø 23,8
TD 1.8	55	03/00→08/03		→ 03/02; - ABS		24.2122-1588.3 011028	ATE Ø 22,2 ohne Druckregler
FORD - FIESTA Stufenheck 04/10→							
 Hauptbremszylinder							
1.4	70	10/10→		+ ABS		24.4120-1710.3 011082	Ø 20,6 ohne Bremsflüssigkeitsbehälter
1.6	62 - 81	09/10→					
1.6 Ti	77 - 88	04/10→		- ABS		24.4120-1711.3 011093	Ø 20,6 ohne Bremsflüssigkeitsbehälter
FORD - FIESTA Stufenheck 09/00→12/14							
 Bremskraftverstärker							
1.0	70	09/04→12/06		für Fahrzeuge ohne Bremsassistent		03.7750-8732.4 300199	ATE Ø 9" pneumatisch
1.4 TDCi	50	05/02→11/11					
1.6	73	05/02→11/13		für Fahrzeuge mit Bremsassistent		03.7853-2102.4 300201	ATE Ø 9" pneumatisch
 Hauptbremszylinder							
1.0	70	09/04→12/06		für Linkslenker; - ABS		03.4153-0015.3 011005	ATE Ø 23,8 ohne Bremsflüssigkeitsbehälter
1.4 TDCi	50	05/02→11/11					
1.6	73	05/02→11/13		für Linkslenker; + ABS		03.4153-5287.4 010953	ATE Ø 23,8 mit Bremsflüssigkeitsbehälter

	kw			 	! #		
FORD - FOCUS I (DAW, DBW) 09/98→11/09							
 Hauptbremszylinder							
1.4 16V	55	10/98→09/99		+ ABS		24.4123-1713.3 010905	BOS Ø 23,8 ohne Bremsflüssigkeitsbehälter
1.4 16V	55	10/98→11/04		11/01→ 09/04; + ESP		03.4123-0153.3 010659	ATE Ø 23,8
1.6 16V	74	10/98→11/04		→ 09/04; + ABS		24.4123-1713.3 010905	BOS Ø 23,8 ohne Bremsflüssigkeitsbehälter
1.8 16V	85	10/98→11/04					
1.8 DI / TDDi	55	08/99→11/04					
1.8 TDCi	85	03/01→11/04					
1.8 Turbo DI / TDDi	66	10/98→11/04					
2.0 16V	96	10/98→11/04					
1.6	76	07/03→06/07		+ ESP		03.4123-0153.3 010659	ATE Ø 23,8
1.8 16V BiFuel	85	09/02→07/04		+ ABS		24.4123-1713.3 010905	BOS Ø 23,8 ohne Bremsflüssigkeitsbehälter
1.6 16V Flexifuel	75	01/02→11/04		→ 09/04; + ESP		03.4123-0153.3 010659	ATE Ø 23,8
1.8 TDCi	74	08/02→11/04		→ 09/04; + ABS		24.4123-1713.3 010905	BOS Ø 23,8 ohne Bremsflüssigkeitsbehälter
FORD - FOCUS I Kasten/Kombi (DNW) 08/98→03/05							
 Hauptbremszylinder							
1.4	55	04/99→03/05		11/01→ 09/04; + ESP		03.4123-0153.3 010659	ATE Ø 23,8
1.6	74	04/99→03/05		→ 09/04; + ABS		24.4123-1713.3 010905	BOS Ø 23,8 ohne Bremsflüssigkeitsbehälter
1.8	85	04/99→03/05					
1.8 TDCi	85	08/01→03/05					
1.8 TDDi	55 - 66	08/98→03/05					
1.8 TDCi	74	08/02→03/05		→ 09/04; + ESP		03.4123-0153.3 010659	ATE Ø 23,8
				→ 09/04; + ABS		24.4123-1713.3 010905	BOS Ø 23,8 ohne Bremsflüssigkeitsbehälter
FORD - FOCUS I Stufenheck (DFW) 02/99→11/09							
 Hauptbremszylinder							
1.4 16V	55	02/99→11/04		11/01→ 09/04; + ESP		03.4123-0153.3 010659	ATE Ø 23,8
1.6 16V	74	02/99→11/04		→ 09/04; + ABS		24.4123-1713.3 010905	BOS Ø 23,8 ohne Bremsflüssigkeitsbehälter
1.8 16V	85	02/99→11/04					
1.8 TDCi	85	03/01→11/04					
1.8 Turbo DI / TDDi	55 - 66	02/99→03/05					
2.0 16V	96	02/99→11/04					
1.8 TDCi	74	08/02→11/04					
				→ 09/04; + ABS		24.4123-1713.3 010905	BOS Ø 23,8 ohne Bremsflüssigkeitsbehälter
FORD - FOCUS I Turnier (DNW) 02/99→12/07							
 Hauptbremszylinder							
1.4 16V	55	02/99→11/04		11/01→ 09/04; + ESP		03.4123-0153.3 010659	ATE Ø 23,8
1.6 16V	74	02/99→11/04		→ 09/04; + ABS		24.4123-1713.3 010905	BOS Ø 23,8 ohne Bremsflüssigkeitsbehälter
1.8 16V	85	02/99→11/04					
1.8 DI / TDDi	55	08/99→11/04					
1.8 TDCi	85	03/01→11/04					
1.8 Turbo DI / TDDi	66	02/99→11/04					
2.0 16V	96	02/99→11/04					
1.6 16V Flexifuel	75	01/02→11/04		→ 09/04; + ESP		03.4123-0153.3 010659	ATE Ø 23,8
1.8 TDCi	74	08/02→11/04		→ 09/04; + ABS		24.4123-1713.3 010905	BOS Ø 23,8 ohne Bremsflüssigkeitsbehälter
1.8 BiFuel	82	02/03→01/05		+ ESP		03.4123-0153.3 010659	ATE Ø 23,8
				+ ABS		24.4123-1713.3 010905	BOS Ø 23,8 ohne Bremsflüssigkeitsbehälter
FORD - FOCUS II (DA_, HCP, DP) 07/04→09/13							
 Bremskraftverstärker							
1.4	59	07/04→09/12		05/07→ 02/11; + ABS / für Fahrzeuge ohne Bremsassistent		03.7760-2232.4 300266	ATE Ø 10" pneumatisch
1.6	74	07/04→09/12		10/04→ 02/11; - ABS / für Fahrzeuge ohne Bremsassistent		03.7760-2332.4 300267	ATE Ø 10" pneumatisch
1.6 TDCi	74 - 80	07/04→09/12					
1.6 Ti	85	07/04→09/12		10/04→ 04/07; + ABS / für Fahrzeuge ohne Bremsassistent		03.7760-8103.4 300240	ATE Ø 10" pneumatisch
2.0	107	07/04→09/12		10/04→ 04/07; + ABS / für Fahrzeuge mit Bremsassistent		03.7863-0332.4 300203	ATE Ø 10" pneumatisch
2.0 TDCi	100	07/04→09/12					
				05/07→ 02/11; + ABS / für Fahrzeuge mit Bremsassistent		03.7863-3932.4 300288	ATE Ø 10" pneumatisch
1.6	81	01/10→09/12		+ ABS / für Fahrzeuge ohne Bremsassistent		03.7760-2232.4 300266	ATE Ø 10" pneumatisch
2.0 Flex →	107	10/08→03/10					

	kw					! #		
FORD - FOCUS II (DA_, HCP, DP) 07/04→09/13								
Bremskraftverstärker								
1.6 2.0 Flex	81 107	01/10→09/12 10/08→03/10		- ABS / für Fahrzeuge ohne Bremsassistent		03.7760-2332.4	300267	ATE Ø 10" pneumatisch
				+ ABS / für Fahrzeuge mit Bremsassistent		03.7863-3932.4	300288	ATE Ø 10" pneumatisch
1.6 LPG 2.0 CNG 2.0 LPG 2.0 TDCi	85 107 107 81	10/09→07/11 04/09→07/11 06/08→07/11 02/08→07/11		→ 02/11; + ABS / für Fahrzeuge ohne Bremsassistent		03.7760-2232.4	300266	ATE Ø 10" pneumatisch
				→ 02/11; - ABS / für Fahrzeuge ohne Bremsassistent		03.7760-2332.4	300267	ATE Ø 10" pneumatisch
				→ 02/11; + ABS / für Fahrzeuge mit Bremsassistent		03.7863-3932.4	300288	ATE Ø 10" pneumatisch
1.6 TDCi 1.8 1.8 Flexifuel 1.8 TDCi	66 92 92 85	01/05→09/12 03/06→09/12 01/06→09/12 01/05→09/12		05/07→ 02/11; + ABS / für Fahrzeuge ohne Bremsassistent		03.7760-2232.4	300266	ATE Ø 10" pneumatisch
				→ 02/11; - ABS / für Fahrzeuge ohne Bremsassistent		03.7760-2332.4	300267	ATE Ø 10" pneumatisch
				→ 04/07; + ABS / für Fahrzeuge ohne Bremsassistent		03.7760-8103.4	300240	ATE Ø 10" pneumatisch
				→ 04/07; + ABS / für Fahrzeuge mit Bremsassistent		03.7863-0332.4	300203	ATE Ø 10" pneumatisch
				05/07→ 02/11; + ABS / für Fahrzeuge mit Bremsassistent		03.7863-3932.4	300288	ATE Ø 10" pneumatisch
2.0	104	06/05→09/08		05/07→; + ABS / für Fahrzeuge ohne Bremsassistent		03.7760-2232.4	300266	ATE Ø 10" pneumatisch
				- ABS / für Fahrzeuge ohne Bremsassistent		03.7760-2332.4	300267	ATE Ø 10" pneumatisch
				→ 04/07; + ABS / für Fahrzeuge ohne Bremsassistent		03.7760-8103.4	300240	ATE Ø 10" pneumatisch
				→ 04/07; + ABS / für Fahrzeuge mit Bremsassistent		03.7863-0332.4	300203	ATE Ø 10" pneumatisch
				05/07→; + ABS / für Fahrzeuge mit Bremsassistent		03.7863-3932.4	300288	ATE Ø 10" pneumatisch
2.0 TDCi	98	07/04→01/08		05/07→; + ABS / für Fahrzeuge ohne Bremsassistent		03.7760-2232.4	300266	ATE Ø 10" pneumatisch
				10/04→; - ABS / für Fahrzeuge ohne Bremsassistent		03.7760-2332.4	300267	ATE Ø 10" pneumatisch
				10/04→ 04/07; + ABS / für Fahrzeuge ohne Bremsassistent		03.7760-8103.4	300240	ATE Ø 10" pneumatisch
				10/04→ 04/07; + ABS / für Fahrzeuge mit Bremsassistent		03.7863-0332.4	300203	ATE Ø 10" pneumatisch
				05/07→; + ABS / für Fahrzeuge mit Bremsassistent		03.7863-3932.4	300288	ATE Ø 10" pneumatisch
2.5 RS 2.5 RS 500	224 257	01/09→07/11 05/10→07/11		für Linkslenker; → 02/11		03.7755-3532.4	300290	ATE Ø 9 / 8" pneumatisch
Hauptbremszylinder								
1.4 1.6 1.6 TDCi	59 74 74 - 80	07/04→09/12 07/04→09/12 07/04→09/12		10/04→ 04/07; + ABS		03.2123-3103.3	010781	ATE Ø 23,8
				05/07→ 10/08; + ABS		03.2125-0483.3	010783	ATE Ø 25,4 ohne Bremsflüssigkeitsbehälter
1.6 Ti 2.0 2.0 TDCi	85 107 100	07/04→09/12 07/04→09/12 07/04→09/12		11/08→ 02/11; + ABS		03.2125-0661.3	010917	ATE Ø 25,4
				10/04→ 02/11; - ABS		24.2123-3041.3	011021	ATE Ø 23,8 ohne Bremsflüssigkeitsbehälter / ohne Druckregler
1.6	81	01/10→09/12		+ ABS		03.2125-0661.3	010917	ATE Ø 25,4
				- ABS		24.2123-3041.3	011021	ATE Ø 23,8 ohne Bremsflüssigkeitsbehälter / ohne Druckregler
1.6 LPG 2.0 CNG	85 107	10/09→07/11 04/09→07/11		→ 02/11; + ABS		03.2125-0661.3	010917	ATE Ø 25,4
				→ 02/11; - ABS		24.2123-3041.3	011021	ATE Ø 23,8 ohne Bremsflüssigkeitsbehälter / ohne Druckregler
1.6 TDCi 1.8 1.8 Flexifuel 1.8 TDCi 2.5 ST	66 92 92 85 166	01/05→09/12 03/06→09/12 01/06→09/12 01/05→09/12 10/05→09/12		→ 04/07; + ABS		03.2123-3103.3	010781	ATE Ø 23,8
				05/07→ 10/08; + ABS		03.2125-0483.3	010783	ATE Ø 25,4 ohne Bremsflüssigkeitsbehälter
				11/08→ 02/11; + ABS		03.2125-0661.3	010917	ATE Ø 25,4
				→ 02/11; - ABS		24.2123-3041.3	011021	ATE Ø 23,8 ohne Bremsflüssigkeitsbehälter / ohne Druckregler
2.0	104	06/05→09/08		→ 04/07; + ABS		03.2123-3103.3	010781	ATE Ø 23,8
				05/07→; + ABS		03.2125-0483.3	010783	ATE Ø 25,4 ohne Bremsflüssigkeitsbehälter
				- ABS		24.2123-3041.3	011021	ATE Ø 23,8 ohne Bremsflüssigkeitsbehälter / ohne Druckregler
2.0 Flex	107	10/08→03/10		+ ABS		03.2125-0661.3	010917	ATE Ø 25,4
2.0 LPG 2.0 TDCi	107 81	06/08→07/11 02/08→07/11		→ 10/08; + ABS		03.2125-0483.3	010783	ATE Ø 25,4 ohne Bremsflüssigkeitsbehälter
				11/08→ 02/11; + ABS		03.2125-0661.3	010917	ATE Ø 25,4
→								



	kw					! #		
FORD - FOCUS II (DA_, HCP, DP) 07/04→09/13								
 Hauptbremszylinder								
2.0 LPG 2.0 TDCi	107 81	06/08→07/11 02/08→07/11		→ 02/11; - ABS			24.2123-3041.3 011021	ATE Ø 23,8 ohne Bremsflüssigkeitsbehälter / ohne Druckregler
2.0 TDCi	98	07/04→01/08		10/04→ 04/07; + ABS			03.2123-3103.3 010781	ATE Ø 23,8
				05/07→; + ABS			03.2125-0483.3 010783	ATE Ø 25,4 ohne Bremsflüssigkeitsbehälter
				10/04→; - ABS			24.2123-3041.3 011021	ATE Ø 23,8 ohne Bremsflüssigkeitsbehälter / ohne Druckregler
2.5 RS 2.5 RS 500	224 257	01/09→07/11 05/10→07/11		für Linkslenker; → 02/11			03.2125-0651.3 010935	ATE Ø 25,4
Hydraulikaggregat, Bremsanlage								
1.4 1.6 1.6 TDCi	59 74 74 - 80	07/04→09/12 07/04→09/12 07/04→09/12		10/04→ 02/11			24.9145-0004.2 399008	
1.6 Ti 2.0 2.0 TDCi	85 107 100	07/04→09/12 07/04→09/12 07/04→09/12						
1.6 2.0 2.0 Flex	81 104 107	01/10→09/12 06/05→09/08 10/08→03/10					24.9145-0004.2 399008	
1.6 LPG 1.6 TDCi 1.8 1.8 Flexifuel 1.8 TDCi 2.0 CNG 2.0 LPG 2.0 TDCi 2.5 ST	85 66 92 92 85 107 107 81 166	10/09→07/11 01/05→09/12 03/06→09/12 01/06→09/12 01/05→09/12 04/09→07/11 06/08→07/11 02/08→07/11 10/05→09/12		→ 02/11			24.9145-0004.2 399008	
2.0 TDCi	98	07/04→01/08		10/04→			24.9145-0004.2 399008	
FORD - FOCUS II Cabriolet 10/06→09/10								
 Bremskraftverstärker								
1.6 2.0 2.0 TDCi	74 107 100	10/06→09/10 10/06→09/10 10/06→09/10		05/07→; + ABS / für Fahrzeuge ohne Bremsassistent			03.7760-2232.4 300266	ATE Ø 10" pneumatisch
2.0 TDCi	100	10/06→09/10		- ABS / für Fahrzeuge ohne Bremsassistent			03.7760-2332.4 300267	ATE Ø 10" pneumatisch
				→ 04/07; + ABS / für Fahrzeuge ohne Bremsassistent			03.7760-8103.4 300240	ATE Ø 10" pneumatisch
				→ 04/07; + ABS / für Fahrzeuge mit Bremsassistent			03.7863-0332.4 300203	ATE Ø 10" pneumatisch
				05/07→; + ABS / für Fahrzeuge mit Bremsassistent			03.7863-3932.4 300288	ATE Ø 10" pneumatisch
 Hauptbremszylinder								
1.6 2.0 2.0 TDCi	74 107 100	10/06→09/10 10/06→09/10 10/06→09/10		→ 04/07; + ABS			03.2123-3103.3 010781	ATE Ø 23,8
2.0 TDCi	100	10/06→09/10		05/07→ 10/08; + ABS			03.2125-0483.3 010783	ATE Ø 25,4 ohne Bremsflüssigkeitsbehälter
				11/08→; + ABS			03.2125-0661.3 010917	ATE Ø 25,4
				- ABS			24.2123-3041.3 011021	ATE Ø 23,8 ohne Bremsflüssigkeitsbehälter / ohne Druckregler
Hydraulikaggregat, Bremsanlage								
1.6 2.0 2.0 TDCi	74 107 100	10/06→09/10 10/06→09/10 10/06→09/10					24.9145-0004.2 399008	
FORD - FOCUS II Kasten/Kombi 07/04→07/11								
 Bremskraftverstärker								
1.4 1.6 1.6 TDCi	59 74 66 - 80	09/05→07/11 09/05→07/11 07/04→07/11		05/07→ 02/11; + ABS / für Fahrzeuge ohne Bremsassistent			03.7760-2232.4 300266	ATE Ø 10" pneumatisch
1.6 TDCi	80	07/04→07/11		→ 02/11; - ABS / für Fahrzeuge ohne Bremsassistent			03.7760-2332.4 300267	ATE Ø 10" pneumatisch
				→ 04/07; + ABS / für Fahrzeuge ohne Bremsassistent			03.7760-8103.4 300240	ATE Ø 10" pneumatisch
1.6 Ti-VCT 2.0 TDCi	85 100	09/05→07/11 09/05→07/11		→ 04/07; + ABS / für Fahrzeuge mit Bremsassistent			03.7863-0332.4 300203	ATE Ø 10" pneumatisch
1.8 Flexifuel	92	06/09→07/11		05/07→ 02/11; + ABS / für Fahrzeuge mit Bremsassistent			03.7863-3932.4 300288	ATE Ø 10" pneumatisch
				+ ABS / für Fahrzeuge ohne Bremsassistent			03.7760-2232.4 300266	ATE Ø 10" pneumatisch
→							03.7760-8103.4 300240	ATE Ø 10" pneumatisch

	kw					! #		
FORD - FOCUS II Kasten/Kombi 07/04→07/11								
 Bremskraftverstärker								
1.8 Flexifuel	92	06/09→07/11		- ABS / für Fahrzeuge ohne Bremsassistent		03.7760-2332.4	300267	ATE Ø 10" pneumatisch
				+ ABS / für Fahrzeuge mit Bremsassistent		03.7863-0332.4	300203	ATE Ø 10" pneumatisch
						03.7863-3932.4	300288	ATE Ø 10" pneumatisch
2.0 TDCi	81	06/09→07/11		→ 02/11; + ABS / für Fahrzeuge ohne Bremsassistent		03.7760-2232.4	300266	ATE Ø 10" pneumatisch
				→ 02/11; - ABS / für Fahrzeuge ohne Bremsassistent		03.7760-2332.4	300267	ATE Ø 10" pneumatisch
				→ 02/11; + ABS / für Fahrzeuge mit Bremsassistent		03.7863-3932.4	300288	ATE Ø 10" pneumatisch
 Hauptbremszylinder								
1.4	59	09/05→07/11		+ ABS		03.2123-3103.3	010781	ATE Ø 23,8
				05/07→ 10/08; + ABS		03.2125-0483.3	010783	ATE Ø 25,4 ohne Bremsflüssigkeitsbehälter
				11/08→ 02/11; + ABS		03.2125-0661.3	010917	ATE Ø 25,4
				- ABS		24.2123-3041.3	011021	ATE Ø 23,8 ohne Bremsflüssigkeitsbehälter / ohne Druckregler
1.6	74	09/05→07/11		+ ABS		03.2123-3103.3	010781	ATE Ø 23,8
				05/07→ 10/08; + ABS		03.2125-0483.3	010783	ATE Ø 25,4 ohne Bremsflüssigkeitsbehälter
				11/08→ 02/11; + ABS		03.2125-0661.3	010917	ATE Ø 25,4
				→ 02/11; - ABS		24.2123-3041.3	011021	ATE Ø 23,8 ohne Bremsflüssigkeitsbehälter / ohne Druckregler
1.6 TDCi	66 - 80	07/04→07/11		→ 04/07; + ABS		03.2123-3103.3	010781	ATE Ø 23,8
1.6 Ti-VCT	85	09/05→07/11		05/07→ 10/08; + ABS		03.2125-0483.3	010783	ATE Ø 25,4 ohne Bremsflüssigkeitsbehälter
2.0 TDCi	100	09/05→07/11		11/08→ 02/11; + ABS		03.2125-0661.3	010917	ATE Ø 25,4
				→ 02/11; - ABS		24.2123-3041.3	011021	ATE Ø 23,8 ohne Bremsflüssigkeitsbehälter / ohne Druckregler
1.8 Flexifuel	92	06/09→07/11		→ 02/11; + ABS		03.2125-0661.3	010917	ATE Ø 25,4
2.0 TDCi	81	06/09→07/11		+ ABS		03.2125-0483.3	010783	ATE Ø 25,4 ohne Bremsflüssigkeitsbehälter
				→ 02/11; + ABS		03.2125-0661.3	010917	ATE Ø 25,4
				→ 02/11; - ABS		24.2123-3041.3	011021	ATE Ø 23,8 ohne Bremsflüssigkeitsbehälter / ohne Druckregler
Hydraulikaggregat, Bremsanlage								
1.4	59	09/05→07/11				24.9145-0004.2	399008	
1.6	74	09/05→07/11						
1.8 Flexifuel	92	06/09→07/11						
1.6 TDCi	66 - 80	07/04→07/11		→ 02/11		24.9145-0004.2	399008	
1.6 Ti-VCT	85	09/05→07/11						
2.0 TDCi	81 - 100	09/05→07/11						
FORD - FOCUS II Stufenheck (DB_, FCH, DH) 04/05→								
 Bremskraftverstärker								
1.4	59	04/05→09/12		05/07→ 02/11; + ABS / für Fahrzeuge ohne Bremsassistent		03.7760-2232.4	300266	ATE Ø 10" pneumatisch
1.6	74	04/05→09/12						
1.6 TDCi	66 - 80	04/05→09/12		→ 02/11; - ABS / für Fahrzeuge ohne Bremsassistent		03.7760-2332.4	300267	ATE Ø 10" pneumatisch
1.6 Ti	85	04/05→09/12						
1.8	92	03/06→09/12		→ 04/07; + ABS / für Fahrzeuge ohne Bremsassistent		03.7760-8103.4	300240	ATE Ø 10" pneumatisch
1.8 Flexifuel	92	06/06→07/11						
1.8 TDCi	85	04/05→09/12		→ 04/07; + ABS / für Fahrzeuge mit Bremsassistent		03.7863-0332.4	300203	ATE Ø 10" pneumatisch
2.0	107	04/05→07/11						
2.0 TDCi	100	04/05→09/12		05/07→ 02/11; + ABS / für Fahrzeuge mit Bremsassistent		03.7863-3932.4	300288	ATE Ø 10" pneumatisch
1.6	81	03/10→		+ ABS / für Fahrzeuge ohne Bremsassistent		03.7760-2232.4	300266	ATE Ø 10" pneumatisch
				- ABS / für Fahrzeuge ohne Bremsassistent		03.7760-2332.4	300267	ATE Ø 10" pneumatisch
				+ ABS / für Fahrzeuge mit Bremsassistent		03.7863-3932.4	300288	ATE Ø 10" pneumatisch
1.8 Flexifuel	96	12/05→01/08		05/07→; + ABS / für Fahrzeuge ohne Bremsassistent		03.7760-2232.4	300266	ATE Ø 10" pneumatisch
				01/06→; - ABS / für Fahrzeuge ohne Bremsassistent		03.7760-2332.4	300267	ATE Ø 10" pneumatisch
				01/06→ 04/07; + ABS / für Fahrzeuge ohne Bremsassistent		03.7760-8103.4	300240	ATE Ø 10" pneumatisch
→								

FORD - FOCUS II Stufenheck (DB_, FCH, DH) 04/05→

Bremskraftverstärker

1.8 Flexifuel	96	12/05→01/08	01/06→ 04/07; + ABS / für Fahrzeuge mit Bremsassistent	03.7863-0332.4	300203	ATE Ø 10" pneumatisch
			05/07→; + ABS / für Fahrzeuge mit Bremsassistent	03.7863-3932.4	300288	ATE Ø 10" pneumatisch
2.0 TDCi	81	02/08→07/11	→ 02/11; + ABS / für Fahrzeuge ohne Bremsassistent	03.7760-2232.4	300266	ATE Ø 10" pneumatisch
			→ 02/11; - ABS / für Fahrzeuge ohne Bremsassistent	03.7760-2332.4	300267	ATE Ø 10" pneumatisch
			→ 02/11; + ABS / für Fahrzeuge mit Bremsassistent	03.7863-3932.4	300288	ATE Ø 10" pneumatisch

Hauptbremszylinder

1.4	59	04/05→09/12	→ 04/07; + ABS	03.2123-3103.3	010781	ATE Ø 23,8
1.6	74	04/05→09/12				
1.6 TDCi	66 - 80	04/05→09/12	05/07→ 10/08; + ABS	03.2125-0483.3	010783	ATE Ø 25,4 ohne Bremsflüssigkeitsbehälter
			11/08→ 02/11; + ABS	03.2125-0661.3	010917	ATE Ø 25,4
1.6 Ti	85	04/05→09/12				
1.8	92	03/06→09/12	→ 02/11; - ABS	24.2123-3041.3	011021	ATE Ø 23,8 ohne Bremsflüssigkeitsbehälter / ohne Druckregler
1.8 Flexifuel	92	06/06→07/11				
1.8 TDCi	85	04/05→09/12				
2.0	107	04/05→07/11				
2.0 TDCi	100	04/05→09/12				
1.6	81	03/10→	+ ABS	03.2125-0661.3	010917	ATE Ø 25,4
			- ABS	24.2123-3041.3	011021	ATE Ø 23,8 ohne Bremsflüssigkeitsbehälter / ohne Druckregler
1.8 Flexifuel	96	12/05→01/08	01/06→ 04/07; + ABS	03.2123-3103.3	010781	ATE Ø 23,8
			05/07→; + ABS	03.2125-0483.3	010783	ATE Ø 25,4 ohne Bremsflüssigkeitsbehälter
			01/06→; - ABS	24.2123-3041.3	011021	ATE Ø 23,8 ohne Bremsflüssigkeitsbehälter / ohne Druckregler
2.0 TDCi	81	02/08→07/11	→ 10/08; + ABS	03.2125-0483.3	010783	ATE Ø 25,4 ohne Bremsflüssigkeitsbehälter
			11/08→ 02/11; + ABS	03.2125-0661.3	010917	ATE Ø 25,4
			→ 02/11; - ABS	24.2123-3041.3	011021	ATE Ø 23,8 ohne Bremsflüssigkeitsbehälter / ohne Druckregler







Hydraulikaggregat, Bremsanlage











1.4	59	04/05→09/12	→ 02/11	24.9145-0004.2	399008	
1.6	74	04/05→09/12				
1.6 TDCi	66 - 80	04/05→09/12				
1.6 Ti	85	04/05→09/12				
1.8	92	03/06→09/12				
1.8 Flexifuel	92	06/06→07/11				
1.8 TDCi	85	04/05→09/12				
2.0	107	04/05→07/11				
2.0 TDCi	81 - 100	04/05→09/12				
1.6	81	03/10→		24.9145-0004.2	399008	
1.8 Flexifuel	96	12/05→01/08	01/06→	24.9145-0004.2	399008	











FORD - FOCUS II Turnier (DA_, FFS, DS) 07/04→09/12

Bremskraftverstärker













1.4	59	07/04→09/12	05/07→ 02/11; + ABS / für Fahrzeuge ohne Bremsassistent	03.7760-2232.4	300266	ATE Ø 10" pneumatisch
1.6	74	07/04→07/11				
1.6 TDCi	74 - 80	07/04→09/12	10/04→ 02/11; - ABS / für Fahrzeuge ohne Bremsassistent	03.7760-2332.4	300267	ATE Ø 10" pneumatisch
			10/04→ 04/07; + ABS / für Fahrzeuge ohne Bremsassistent	03.7760-8103.4	300240	ATE Ø 10" pneumatisch
1.6 Ti	85	07/04→09/12				
2.0	107	07/04→09/12				
2.0 TDCi	100	07/04→09/12	10/04→ 04/07; + ABS / für Fahrzeuge mit Bremsassistent	03.7863-0332.4	300203	ATE Ø 10" pneumatisch
			05/07→ 02/11; + ABS / für Fahrzeuge mit Bremsassistent	03.7863-3932.4	300288	ATE Ø 10" pneumatisch
1.6 LPG	85	10/09→09/12	→ 02/11; + ABS / für Fahrzeuge ohne Bremsassistent	03.7760-2232.4	300266	ATE Ø 10" pneumatisch
1.6 TDCi	81	12/07→09/12				
2.0 LPG	107	06/08→07/11	→ 02/11; - ABS / für Fahrzeuge ohne Bremsassistent	03.7760-2332.4	300267	ATE Ø 10" pneumatisch
2.0 TDCi	81	02/08→07/11	→ 02/11; + ABS / für Fahrzeuge mit Bremsassistent	03.7863-3932.4	300288	ATE Ø 10" pneumatisch
1.6 TDCi	66	07/04→09/12	05/07→ 02/11; + ABS / für Fahrzeuge ohne Bremsassistent	03.7760-2232.4	300266	ATE Ø 10" pneumatisch
1.8 TDCi	85	07/04→09/12	01/05→ 02/11; - ABS / für Fahrzeuge ohne Bremsassistent	03.7760-2332.4	300267	ATE Ø 10" pneumatisch
→						













	kw					! #		
FORD - FOCUS II Turnier (DA, FFS, DS) 07/04→09/12								
Bremskraftverstärker								
1.6 TDCi 1.8 TDCi	66 85	07/04→09/12 07/04→09/12		01/05→04/07; + ABS / für Fahrzeuge ohne Bremsassistent		03.7760-8103.4	300240	ATE Ø 10" pneumatisch
				01/05→04/07; + ABS / für Fahrzeuge mit Bremsassistent		03.7863-0332.4	300203	ATE Ø 10" pneumatisch
				05/07→02/11; + ABS / für Fahrzeuge mit Bremsassistent		03.7863-3932.4	300288	ATE Ø 10" pneumatisch
1.8 1.8 Flexifuel	92 92	03/06→09/12 01/06→09/12		05/07→02/11; + ABS / für Fahrzeuge ohne Bremsassistent		03.7760-2232.4	300266	ATE Ø 10" pneumatisch
				→ 02/11; - ABS / für Fahrzeuge ohne Bremsassistent		03.7760-2332.4	300267	ATE Ø 10" pneumatisch
				→ 04/07; + ABS / für Fahrzeuge ohne Bremsassistent		03.7760-8103.4	300240	ATE Ø 10" pneumatisch
				→ 04/07; + ABS / für Fahrzeuge mit Bremsassistent		03.7863-0332.4	300203	ATE Ø 10" pneumatisch
				05/07→02/11; + ABS / für Fahrzeuge mit Bremsassistent		03.7863-3932.4	300288	ATE Ø 10" pneumatisch
2.0 TDCi	98	07/04→01/08		05/07→; + ABS / für Fahrzeuge ohne Bremsassistent		03.7760-2232.4	300266	ATE Ø 10" pneumatisch
				10/04→; - ABS / für Fahrzeuge ohne Bremsassistent		03.7760-2332.4	300267	ATE Ø 10" pneumatisch
				10/04→04/07; + ABS / für Fahrzeuge ohne Bremsassistent		03.7760-8103.4	300240	ATE Ø 10" pneumatisch
				10/04→04/07; + ABS / für Fahrzeuge mit Bremsassistent		03.7863-0332.4	300203	ATE Ø 10" pneumatisch
				05/07→; + ABS / für Fahrzeuge mit Bremsassistent		03.7863-3932.4	300288	ATE Ø 10" pneumatisch
Hauptbremszylinder								
1.4 1.6 1.6 TDCi	59 74 74 - 80	07/04→09/12 07/04→07/11 07/04→09/12		10/04→04/07; + ABS		03.2123-3103.3	010781	ATE Ø 23,8
				05/07→10/08; + ABS		03.2125-0483.3	010783	ATE Ø 25,4 ohne Bremsflüssigkeitsbehälter
1.6 Ti	85	07/04→09/12		11/08→02/11; + ABS		03.2125-0661.3	010917	ATE Ø 25,4
2.0 2.0 TDCi	107 100	07/04→09/12 07/04→09/12		10/04→02/11; - ABS		24.2123-3041.3	011021	ATE Ø 23,8 ohne Bremsflüssigkeitsbehälter / ohne Druckregler
1.6 LPG	85	10/09→09/12		→ 02/11; + ABS		03.2125-0661.3	010917	ATE Ø 25,4
				→ 02/11; - ABS		24.2123-3041.3	011021	ATE Ø 23,8 ohne Bremsflüssigkeitsbehälter / ohne Druckregler
1.6 TDCi 1.8 TDCi	66 85	07/04→09/12 07/04→09/12		01/05→04/07; + ABS		03.2123-3103.3	010781	ATE Ø 23,8
				05/07→10/08; + ABS		03.2125-0483.3	010783	ATE Ø 25,4 ohne Bremsflüssigkeitsbehälter
				11/08→02/11; + ABS		03.2125-0661.3	010917	ATE Ø 25,4
				01/05→02/11; - ABS		24.2123-3041.3	011021	ATE Ø 23,8 ohne Bremsflüssigkeitsbehälter / ohne Druckregler
1.6 TDCi 2.0 LPG 2.0 TDCi	81 107 81	12/07→09/12 06/08→07/11 02/08→07/11		→ 10/08; + ABS		03.2125-0483.3	010783	ATE Ø 25,4 ohne Bremsflüssigkeitsbehälter
				11/08→02/11; + ABS		03.2125-0661.3	010917	ATE Ø 25,4
				→ 02/11; - ABS		24.2123-3041.3	011021	ATE Ø 23,8 ohne Bremsflüssigkeitsbehälter / ohne Druckregler
1.8 1.8 Flexifuel	92 92	03/06→09/12 01/06→09/12		→ 04/07; + ABS		03.2123-3103.3	010781	ATE Ø 23,8
				05/07→10/08; + ABS		03.2125-0483.3	010783	ATE Ø 25,4 ohne Bremsflüssigkeitsbehälter
				11/08→02/11; + ABS		03.2125-0661.3	010917	ATE Ø 25,4
				→ 02/11; - ABS		24.2123-3041.3	011021	ATE Ø 23,8 ohne Bremsflüssigkeitsbehälter / ohne Druckregler
2.0 TDCi	98	07/04→01/08		10/04→04/07; + ABS		03.2123-3103.3	010781	ATE Ø 23,8
				05/07→; + ABS		03.2125-0483.3	010783	ATE Ø 25,4 ohne Bremsflüssigkeitsbehälter
				10/04→; - ABS		24.2123-3041.3	011021	ATE Ø 23,8 ohne Bremsflüssigkeitsbehälter / ohne Druckregler
Hydraulikaggregat, Bremsanlage								
1.4 1.6 1.6 TDCi	59 74 74 - 80	07/04→09/12 07/04→07/11 07/04→09/12		10/04→02/11		24.9145-0004.2	399008	
1.6 Ti 2.0 2.0 TDCi	85 107 100	07/04→09/12 07/04→09/12 07/04→09/12						
1.6 LPG 1.6 TDCi 1.8 1.8 Flexifuel	85 81 92 92	10/09→09/12 12/07→09/12 03/06→09/12 01/06→09/12		→ 02/11		24.9145-0004.2	399008	















	kW			 	! #		
FORD - FOCUS II Turnier (DA, FFS, DS) 07/04→09/12							
Hydraulikaggregat, Bremsanlage							
2.0 LPG	107	06/08→07/11		→ 02/11		24.9145-0004.2	399008
2.0 TDCi	81	02/08→07/11					
1.6 TDCi	66	07/04→09/12		01/05→ 02/11		24.9145-0004.2	399008
1.8 TDCi	85	07/04→09/12					
2.0 TDCi	98	07/04→01/08		10/04→		24.9145-0004.2	399008
FORD - FOCUS III 07/10→02/20							
 Hauptbremszylinder							
1.0 EcoBoost	74 - 103	02/12→02/20				03.4155-5451.3	010995 ATE Ø 25,4
1.5 EcoBoost	110 - 134	09/14→12/17					
1.5 TDCi	70 - 88	09/14→12/17					
1.5 TDCi ECONetic	77	09/14→12/17					
1.6 Flexifuel	110	07/13→02/20					
1.6 LPG	86 - 88	02/12→02/20					
1.6 TDCi ECONetic	77	05/12→07/15					
1.6 Ti	63 - 88	08/11→12/17					
2.0 ST	184	07/12→12/17					
2.0 TDCi	110	11/14→12/17					
2.0 TDCi ST	136	11/14→12/17					
1.6 EcoBoost	110 - 134	07/10→06/14		03/11→		03.4155-5451.3	010995 ATE Ø 25,4
1.6 Flexifuel	88	07/10→02/20					
1.6 TDCi	70 - 85	07/10→12/17					
1.6 Ti	77 - 92	07/10→02/20					
2.0 TDCi	85 - 120	07/10→06/14					
2.0	119	09/11→12/17				03.4155-5456.3	010996 ATE Ø 25,4
2.0 Ti-GDi	125	08/11→02/20					
2.3 RS AWD	257	07/15→12/17					
FORD - FOCUS III Kasten/Kombi 02/12→02/20							
 Hauptbremszylinder							
1.0 EcoBoost	74 - 92	02/12→02/20				03.4155-5451.3	010995 ATE Ø 25,4
1.5 EcoBoost	110 - 134	09/14→02/20					
1.5 TDCi	70 - 88	09/14→02/20					
1.5 TDCi ECONetic	77	09/14→02/20					
2.0 TDCi	110	11/14→02/20					
FORD - FOCUS III Kasten/Schrägheck 01/11→02/20							
 Hauptbremszylinder							
1.0 EcoBoost	74 - 92	02/12→12/17				03.4155-5451.3	010995 ATE Ø 25,4
1.5 EcoBoost	110 - 134	09/14→12/17					
1.5 TDCi	70 - 88	09/14→12/17					
1.5 TDCi ECONetic	77	09/14→12/17					
1.6 EcoBoost	110 - 134	11/11→06/14					
1.6 TDCi	85	02/12→12/17					
2.0 TDCi	110	11/14→12/17					
1.6 TDCi	70	01/11→12/17		03/11→		03.4155-5451.3	010995 ATE Ø 25,4
1.6 Ti	77	01/11→02/20					
2.0 TDCi	85 - 120	01/11→06/14					
FORD - FOCUS III Stufenheck 07/10→02/20							
 Hauptbremszylinder							
1.0 EcoBoost	74 - 103	02/12→02/20				03.4155-5451.3	010995 ATE Ø 25,4
1.5 EcoBoost	110 - 134	11/14→02/20					
1.5 TDCi	70 - 88	11/14→02/20					
1.5 TDCi ECONetic	77	11/14→02/20					
1.6 Flexifuel	110	07/13→02/20					
1.6 TDCi	77	05/12→07/15					
1.6 Ti	63	08/11→02/20					
→							















	kw			 	! #		
FORD - FOCUS III Stufenheck 07/10→02/20							
 Hauptbremszylinder							
2.0 TDCi	110	11/14→02/20				03.4155-5451.3 010995	ATE Ø 25,4
1.6 EcoBoost	110 - 134	07/10→06/14		03/11→		03.4155-5451.3 010995	ATE Ø 25,4
1.6 Flexifuel	88	07/10→02/20					
1.6 TDCi	70 - 85	07/10→02/20					
1.6 Ti	77 - 92	07/10→02/20					
2.0 TDCi	85 - 120	07/10→06/14					
2.0 GDi	125	08/11→02/20				03.4155-5456.3 010996	ATE Ø 25,4
FORD - FOCUS III Turnier 07/10→02/20							
 Hauptbremszylinder							
1.0 EcoBoost	74 - 103	02/12→02/20				03.4155-5451.3 010995	ATE Ø 25,4
1.5 EcoBoost	110 - 134	09/14→02/20					
1.5 TDCi	70 - 88	09/14→02/20					
1.5 TDCi ECONetic	77	09/14→02/20					
1.6 Flexifuel	110	07/13→02/20					
1.6 LPG	86 - 88	02/12→02/20					
1.6 TDCi ECONetic	77	05/12→07/15					
1.6 Ti	63 - 88	08/11→02/20					
2.0 ST	184	07/12→02/20					
2.0 TDCi	110	11/14→02/20					
2.0 TDCi ST	136	11/14→02/20					
1.6 EcoBoost	110 - 134	07/10→06/14		03/11→		03.4155-5451.3 010995	ATE Ø 25,4
1.6 Flexifuel	88	07/10→02/20					
1.6 TDCi	70 - 85	07/10→02/20					
1.6 Ti	77 - 92	07/10→02/20					
2.0 TDCi	85 - 120	07/10→06/14					
2.0 Ti-GDi	125	07/10→02/20		08/11→		03.4155-5456.3 010996	ATE Ø 25,4
FORD - FOCUS C-MAX (DM2) 10/03→03/07							
 Bremskraftverstärker							
1.6	74	10/03→03/07		09/06→; für Fahrzeuge ohne Bremsassistent		03.7760-2232.4 300266	ATE Ø 10" pneumatisch
1.6 TDCi	66 - 80	10/03→03/07		→ 08/06; für Fahrzeuge ohne Bremsassistent		03.7760-8103.4 300240	ATE Ø 10" pneumatisch
1.6 Ti	85	08/04→03/07		→ 08/06; für Fahrzeuge ohne Bremsassistent		03.7863-0332.4 300203	ATE Ø 10" pneumatisch
1.8	88 - 92	10/03→03/07		→ 08/06; für Fahrzeuge mit Bremsassistent		03.7863-0332.4 300203	ATE Ø 10" pneumatisch
1.8 Flexifuel	92	01/06→03/07					
2.0 TDCi	98 - 100	10/03→03/07		09/06→; für Fahrzeuge mit Bremsassistent		03.7863-3932.4 300288	ATE Ø 10" pneumatisch
1.8 TDCi	85	01/05→03/07		09/06→; für Fahrzeuge ohne Bremsassistent		03.7760-2232.4 300266	ATE Ø 10" pneumatisch
				→ 08/06; für Fahrzeuge ohne Bremsassistent		03.7760-8103.4 300240	ATE Ø 10" pneumatisch
				08/06→; für Fahrzeuge mit Bremsassistent		03.7863-0332.4 300203	ATE Ø 10" pneumatisch
				→ 07/06; für Fahrzeuge mit Bremsassistent		03.7863-3932.4 300288	ATE Ø 10" pneumatisch
2.0	107	03/04→03/07		09/06→; für Fahrzeuge ohne Bremsassistent		03.7760-2232.4 300266	ATE Ø 10" pneumatisch
				04/04→ 08/06; für Fahrzeuge ohne Bremsassistent		03.7760-8103.4 300240	ATE Ø 10" pneumatisch
				04/04→ 08/06; für Fahrzeuge mit Bremsassistent		03.7863-0332.4 300203	ATE Ø 10" pneumatisch
				09/06→; für Fahrzeuge mit Bremsassistent		03.7863-3932.4 300288	ATE Ø 10" pneumatisch
 Hauptbremszylinder							
1.6	74	10/03→03/07				03.2123-3103.3 010781	ATE Ø 23,8
1.6 TDCi	66 - 80	10/03→03/07				03.2125-0483.3 010783	ATE Ø 25,4 ohne Bremsflüssigkeitsbehälter
1.6 Ti	85	08/04→03/07					
1.8	88 - 92	10/03→03/07					
1.8 Flexifuel	92	01/06→03/07					
→							



























	kw					! #		
FORD - FOCUS C-MAX (DM2) 10/03→03/07								
 Hauptbremszylinder								
1.8 TDCi 2.0 TDCi	85 98 - 100	01/05→03/07 10/03→03/07				03.2123-3103.3 03.2125-0483.3	010781 010783	ATE Ø 23,8 ATE Ø 25,4 ohne Bremsflüssigkeitsbehälter
2.0	107	03/04→03/07		04/04→		03.2123-3103.3 03.2125-0483.3	010781 010783	ATE Ø 23,8 ATE Ø 25,4 ohne Bremsflüssigkeitsbehälter
Hydraulikaggregat, Bremsanlage								
1.6 1.6 TDCi 1.6 Ti 1.8 1.8 Flexifuel 1.8 TDCi 2.0 TDCi 2.0	74 66 - 80 85 88 - 92 92 85 98 - 100 107	10/03→03/07 10/03→03/07 08/04→03/07 10/03→03/07 01/06→03/07 01/05→03/07 10/03→03/07 03/04→03/07				24.9145-0004.2	399008	
FORD - FUSION (JU_) 08/02→12/12								
 Bremskraftverstärker								
1.25 1.4 1.4 LPG 1.4 TDCi 1.6 TDCi 1.3 1.6	55 59 59 50 66 44 74	08/04→12/12 08/02→12/12 01/10→12/12 08/02→12/12 11/04→12/12 11/02→07/05 08/02→11/09		→ 09/12; für Fahrzeuge ohne Bremsassistent → 09/12; für Fahrzeuge mit Bremsassistent für Fahrzeuge ohne Bremsassistent für Fahrzeuge mit Bremsassistent		03.7750-8732.4 03.7853-2102.4 03.7750-8732.4 03.7853-2102.4	300199 300201 300199 300201	ATE Ø 9" pneumatisch ATE Ø 9" pneumatisch ATE Ø 9" pneumatisch ATE Ø 9" pneumatisch
 Hauptbremszylinder								
1.25 1.4 1.4 LPG 1.4 TDCi 1.6 TDCi 1.3 1.6	55 59 59 50 66 44 74	08/04→12/12 08/02→12/12 01/10→12/12 08/02→12/12 11/04→12/12 11/02→07/05 08/02→11/09		→ 09/12; für Linkslenker; - ABS → 09/12; für Linkslenker für Linkslenker; - ABS für Linkslenker; - ABS für Linkslenker		03.4153-0015.3 03.4153-5287.4 03.4153-0015.3 03.4153-0015.3 03.4153-5287.4	011005 010953 011005 011005 010953	ATE Ø 23,8 ohne Bremsflüssigkeitsbehälter ATE Ø 23,8 mit Bremsflüssigkeitsbehälter ATE Ø 23,8 ohne Bremsflüssigkeitsbehälter ATE Ø 23,8 ohne Bremsflüssigkeitsbehälter ATE Ø 23,8 mit Bremsflüssigkeitsbehälter
FORD - GALAXY I (WGR) 03/95→05/06								
 Bremskraftverstärker								
1.9 TDI 1.9 TDI 1.9 TDI 1.9 TDI 1.9 TDI 1.9 TDI 1.9 TDI 1.9 TDI 2.0 i 2.3 16V 2.8 i V6 2.8 i V6 4x4	66 81 85 103 150 96 110 85 107 128 128	03/95→05/06 08/97→04/00 04/00→05/06 09/01→05/06 04/00→05/06 02/03→05/06 05/05→05/06 11/95→05/06 01/97→05/06 11/95→04/00 04/96→04/00		09/97→ 03/00; für Linkslenker; + ABS 04/00→ 10/02; für Linkslenker; - ESP 04/00→ 04/06; für Rechtslenker; - ESP 01/96→ 08/97; für Linkslenker 04/00→ 10/02; für Linkslenker; + ESP 10/97→ 03/00; für Linkslenker; + ABS → 10/02; für Linkslenker; - ESP → 04/06; für Rechtslenker; - ESP für Rechtslenker; - ESP 09/97→ 03/00; für Linkslenker; + ABS 04/00→ 04/06; für Rechtslenker; - ESP 04/00→ 10/02; für Linkslenker; - ESP → 08/97; für Linkslenker 04/00→ 10/02; für Linkslenker; + ESP 09/97→ 03/00; für Linkslenker; + ABS → 08/97; für Linkslenker		03.7755-1902.4 03.7755-6302.4 03.7755-6302.4 03.7760-3002.4 03.7858-3302.4 03.7755-1902.4 03.7755-6302.4 03.7755-6302.4 03.7858-3302.4 03.7755-6302.4 03.7755-6302.4 03.7755-6302.4 03.7755-6302.4 03.7760-3002.4 03.7858-3302.4 03.7755-1902.4 03.7760-3002.4	300138 300221 300221 300120 300122 300138 300221 300221 300122 300221 300221 300221 300221 300120 300122 300138 300120	ATE Ø 9 / 8" pneumatisch ATE Ø 9 / 8" pneumatisch ATE Ø 9 / 8" pneumatisch ATE Ø 10" pneumatisch ATE Ø 9 / 8" pneumatisch ATE Ø 9 / 8" pneumatisch ATE Ø 9 / 8" pneumatisch ATE Ø 9 / 8" pneumatisch ATE Ø 9 / 8" pneumatisch ATE Ø 9 / 8" pneumatisch ATE Ø 9 / 8" pneumatisch ATE Ø 9 / 8" pneumatisch ATE Ø 9 / 8" pneumatisch ATE Ø 10" pneumatisch ATE Ø 9 / 8" pneumatisch ATE Ø 9 / 8" pneumatisch ATE Ø 10" pneumatisch
 Hauptbremszylinder								
1.9 TDI	66	03/95→05/06		01/96→ 08/97; + ABS 01/96→ 08/97; - ABS 04/00→ 10/02; - ESP		03.2123-1526.3 03.2123-1548.3 03.2125-0332.3	010477 010478 010952	Ø 23,8 Ø 23,8 Ø 25,4













	kw			 	! #		
FORD - GALAXY I (WGR) 03/95→05/06							
 Hauptbremszylinder							
1.9 TDI	66	03/95→05/06		09/97→ 03/00; + ABS		03.2125-0332.3 010952	Ø 25,4
				11/02→ 04/06; - ESP		03.2125-0332.3 010952	Ø 25,4
				09/97→ 03/00; - ABS		03.2125-8404.3 010583	ATE Ø 25,4
				04/00→ 10/02; + ESP		03.2125-9604.3 010581	Ø 25,4
1.9 TDI	81	08/97→04/00		10/97→ 03/00; + ABS		03.2125-0332.3 010952	Ø 25,4
				10/97→ 03/00; - ABS		03.2125-8404.3 010583	ATE Ø 25,4
1.9 TDI 2.3 16V 2.8 V6	85	04/00→05/06		11/02→ 04/06; - ESP		03.2125-0332.3 010952	Ø 25,4
	103	09/01→05/06		→ 10/02; - ESP		03.2125-0332.3 010952	Ø 25,4
	150	04/00→05/06		→ 10/02; + ESP		03.2125-9604.3 010581	Ø 25,4
1.9 TDI	96	02/03→05/06		→ 04/06; - ESP		03.2125-0332.3 010952	Ø 25,4
1.9 TDI	110	05/05→05/06		- ESP		03.2125-0332.3 010952	Ø 25,4
2.0 i 2.3 16V	85	11/95→05/06		→ 08/97; + ABS		03.2123-1526.3 010477	Ø 23,8
	107	01/97→05/06		→ 08/97; - ABS		03.2123-1548.3 010478	Ø 23,8
				04/00→ 10/02; - ESP		03.2125-0332.3 010952	Ø 25,4
				09/97→ 03/00; + ABS		03.2125-0332.3 010952	Ø 25,4
				11/02→ 04/06; - ESP		03.2125-0332.3 010952	Ø 25,4
				09/97→ 03/00; - ABS		03.2125-8404.3 010583	ATE Ø 25,4
2.8 i V6 2.8 i V6 4x4	128	11/95→04/00		→ 08/97; + ABS		03.2123-1526.3 010477	Ø 23,8
	128	04/96→04/00		→ 08/97; - ABS		03.2123-1548.3 010478	Ø 23,8
				09/97→ 03/00; + ABS		03.2125-0332.3 010952	Ø 25,4
				09/97→ 03/00; - ABS		03.2125-8404.3 010583	ATE Ø 25,4
Verschlusschraube, Hauptbremszylinder							
1.9 TDI	66	03/95→05/06		01/96→ 08/97; - ABS		03.3517-5100.1 390326	
2.0 i 2.3 16V 2.8 i V6 2.8 i V6 4x4	85 107 128 128	11/95→05/06 01/97→05/06 11/95→04/00 04/96→04/00		→ 08/97; - ABS		03.3517-5100.1 390326	
FORD - GALAXY II (WA6) 05/06→06/15							
 Bremskraftverstärker							
1.6 EcoBoost	118	11/10→06/15		02/11→		03.7755-1432.4 300300	ATE Ø 9 / 8" pneumatisch
1.6 TDCi	85	02/11→06/15				03.7755-1432.4 300300	ATE Ø 9 / 8" pneumatisch
1.8 TDCi	74 - 92	05/06→06/15					
2.0	107	05/06→06/15					
2.0 EcoBoost	146 - 149	03/10→06/15					
2.0 Flexifuel	107	05/06→06/15					
2.0 TDCi	85 - 120	05/06→06/15					
2.2 TDCi	147	11/10→06/15					
2.3	118	09/07→06/15					
2.2 TDCi	129	03/08→12/12		04/08→		03.7755-1432.4 300300	ATE Ø 9 / 8" pneumatisch
FORD - GALAXY MK I VAN (WGR) 03/95→05/06							
 Bremskraftverstärker							
2.3	103	11/02→03/06		für Rechtslenker; - ESP		03.7755-6302.4 300221	ATE Ø 9 / 8" pneumatisch
 Hauptbremszylinder							
2.3	103	11/02→03/06		- ESP		03.2125-0332.3 010952	Ø 25,4
FORD - GALAXY MK II VAN (WA6) 05/06→06/15							
 Bremskraftverstärker							
2.0	107	05/06→06/15				03.7755-1432.4 300300	ATE Ø 9 / 8" pneumatisch
2.0 EcoBoost	149	03/10→06/15					
EcoBoost	118	02/11→06/15					
TDCi	85 - 147	05/06→06/15					
TDCi	85	01/07→06/15		02/11→		03.7755-1432.4 300300	ATE Ø 9 / 8" pneumatisch
FORD - GRAND C-MAX (DXA/CB7, DXA/CEU) 12/10→06/19							
 Hauptbremszylinder							
1.0 EcoBoost	74 - 92	10/12→06/19		für Linkslenker		03.4155-5456.3 010996	ATE Ø 25,4
→							















	kw					! #		
FORD - GRAND C-MAX (DXA/CB7, DXA/CEU) 12/10→06/19								
 Hauptbremszylinder								
1.5 EcoBoost	110 - 134	03/15→06/19			für Linkslenker		03.4155-5456.3 010996	ATE Ø 25,4
1.5 TDCi	70 - 88	03/15→06/19						
1.6 EcoBoost	110 - 134	12/10→06/19						
1.6 TDCi	70 - 85	12/10→06/19						
1.6 Ti	63 - 92	12/10→06/19						
2.0 TDCi	85 - 120	12/10→06/19			für Linkslenker		03.4155-5451.3 010995	ATE Ø 25,4
							03.4155-5456.3 010996	ATE Ø 25,4
2.0 TDCi	100 - 125	02/11→06/19			für Linkslenker		03.4155-5451.3 010995	ATE Ø 25,4
FORD - GRAND C-MAX Van 12/10→06/19								
 Hauptbremszylinder								
1.0 EcoBoost	74 - 92	10/12→06/19			für Linkslenker		03.4155-5456.3 010996	ATE Ø 25,4
1.5 EcoBoost	110	03/15→06/19						
1.5 TDCi	88	03/15→06/19						
1.6 EcoBoost	110 - 134	12/10→06/19						
1.6 TDCi	70 - 85	12/10→06/19						
1.6 Ti	92	12/10→12/14						
2.0 TDCi	103 - 120	12/10→06/19			für Linkslenker		03.4155-5451.3 010995	ATE Ø 25,4
							03.4155-5456.3 010996	ATE Ø 25,4
2.0 TDCi	85	02/11→06/19						
2.0 TDCi	110 - 125	03/15→06/19			für Linkslenker		03.4155-5451.3 010995	ATE Ø 25,4
FORD - KA 01/08→								
 Hauptbremszylinder								
1.0	46 - 48	10/08→					24.4120-1706.3 011072	Ø 20,6 ohne Bremsflüssigkeitsbehälter
FORD - KA (RU8) 10/08→05/16								
 Hauptbremszylinder								
1.2	51	10/08→05/16					24.4120-1706.3 011072	Ø 20,6 ohne Bremsflüssigkeitsbehälter
1.3 TDCi	55	10/08→05/16						
FORD - KUGA I 02/08→11/12								
 Bremskraftverstärker								
2.0 TDCi	100	03/08→11/12			04/08→; für Linkslenker		03.7755-3532.4 300290	ATE Ø 9 / 8" pneumatisch
2.0 TDCi 4x4	100	03/08→11/12			04/08→; für Rechtslenker		03.7760-2232.4 300266	ATE Ø 10" pneumatisch
2.0 TDCi	103	03/10→11/12			für Linkslenker		03.7755-3532.4 300290	ATE Ø 9 / 8" pneumatisch
2.0 TDCi 4x4	103 - 120	03/10→11/12			für Rechtslenker		03.7760-2232.4 300266	ATE Ø 10" pneumatisch
2.5 4x4	147	02/08→11/12			für Linkslenker		03.7755-3532.4 300290	ATE Ø 9 / 8" pneumatisch
 Hauptbremszylinder								
2.0 TDCi	100	03/08→11/12			04/08→; für Rechtslenker; → 10/08		03.2125-0483.3 010783	ATE Ø 25,4 ohne Bremsflüssigkeitsbehälter
2.0 TDCi 4x4	100	03/08→11/12			11/08→; für Linkslenker		03.2125-0651.3 010935	ATE Ø 25,4
					11/08→; für Rechtslenker		03.2125-0661.3 010917	ATE Ø 25,4
2.0 TDCi	103	03/10→11/12			für Linkslenker		03.2125-0651.3 010935	ATE Ø 25,4
2.0 TDCi 4x4	103 - 120	03/10→11/12						
2.5 4x4	147	02/08→11/12						
Hydraulikaggregat, Bremsanlage								
2.0 TDCi	100	03/08→11/12			04/08→		24.9145-0004.2 399008	
2.0 TDCi 4x4	100	03/08→11/12						
2.0 TDCi	103	03/10→11/12					24.9145-0004.2 399008	
2.0 TDCi 4x4	103 - 120	03/10→11/12						
2.5 4x4	147	02/08→11/12						
FORD - KUGA I VAN 02/08→11/12								
 Bremskraftverstärker								
2.5	147	02/08→11/12			für Linkslenker		03.7755-3532.4 300290	ATE Ø 9 / 8" pneumatisch
→								













	kw			 	! #		
FORD - KUGA I VAN 02/08→11/12							
 Bremskraftverstärker							
TDCi	103	03/10→11/12		für Linkslenker	03.7755-3532.4	300290	ATE Ø 9 / 8" pneumatisch
TDCi 4x4	103 - 120	03/10→11/12		für Rechtslenker	03.7760-2232.4	300266	ATE Ø 10" pneumatisch
 Hauptbremszylinder							
2.5 TDCi	147	02/08→11/12		für Linkslenker	03.2125-0651.3	010935	ATE Ø 25,4
TDCi 4x4	103 - 120	03/10→11/12					
Hydraulikaggregat, Bremsanlage							
2.5 TDCi	147	02/08→11/12			24.9145-0004.2	399008	
TDCi 4x4	103 - 120	03/10→11/12					
FORD - KUGA II (DM2) 05/12→							
 Hauptbremszylinder							
1.5 EcoBoost	88 - 134	09/14→			03.4155-5456.3	010996	ATE Ø 25,4
1.5 EcoBoost 4x4	110 - 134	09/14→					
1.6 EcoBoost	110	03/13→09/14					
1.6 EcoBoost 4x4	110 - 134	10/12→04/15					
2.0 TDCi	85 - 110	03/13→					
2.0 TDCi 4x4	100 - 132	03/13→					
2.5	110 - 125	09/13→					
1.5 EcoBoost 4x4	129	08/18→06/19		für Linkslenker	03.4155-5456.3	010996	ATE Ø 25,4
1.5 EcoBoost E85	110	02/19→11/19					
2.0 EcoBoost 4x4	169	03/19→					
2.0 4x4	179	03/13→06/16		für Linkslenker; für Fahrzeuge mit Start-Stopp-Funktion	03.4155-5456.3	010996	ATE Ø 25,4
2.0 EcoBoost 4x4	178	08/17→06/18					
FORD - KUGA II VAN 05/12→							
 Hauptbremszylinder							
1.5 EcoBoost	88	06/19→		für Linkslenker	03.4155-5456.3	010996	ATE Ø 25,4
1.5 EcoBoost 4x4	129	06/19→					
1.5 EcoBoost	110	09/14→			03.4155-5456.3	010996	ATE Ø 25,4
1.5 EcoBoost 4x4	134	09/14→					
2.0 TDCi	88 - 110	09/14→					
2.0 TDCi 4x4	110 - 132	09/14→					
FORD - MONDEO II (BAP) 08/96→09/00							
 Hauptbremszylinder							
1.6 i	66	08/96→09/00		10/96→; + ABS	24.2125-1709.3	010499	Ø 25,4
1.8 i	85	08/96→09/00					
1.8 TD	66	08/96→09/00					
2.0 i	96	08/96→09/00					
2.5 24V	125	08/96→09/00					
1.6 i 16V	70	05/98→09/00		+ ABS	24.2125-1709.3	010499	Ø 25,4
2.5 24V	125	06/00→09/00					
2.5 ST 200	151	05/99→09/00					
FORD - MONDEO II Stufenheck (BFP) 08/96→09/00							
 Hauptbremszylinder							
1.6 i	66	08/96→09/00		10/96→; + ABS	24.2125-1709.3	010499	Ø 25,4
1.8 i	85	08/96→09/00					
1.8 TD	66	08/96→09/00					
2.0 i	96	08/96→09/00					
2.5 24V	125	08/96→09/00					
1.6 i 16V	70	05/98→09/00		+ ABS	24.2125-1709.3	010499	Ø 25,4
2.5 24V	125	06/00→09/00					
2.5 ST 200	151	05/99→09/00					
FORD - MONDEO II Turnier (BNP) 08/96→09/00							
 Hauptbremszylinder							
1.6 i	66	08/96→09/00		10/96→; + ABS	24.2125-1709.3	010499	Ø 25,4
1.8 i	85	08/96→09/00					
1.8 TD	66	08/96→09/00					
2.0 i	96	08/96→09/00					
→							



















	kw			 	! #		
FORD - MONDEO II Turnier (BNP) 08/96→09/00							
 Hauptbremszylinder							
2.5 24V	125	08/96→09/00		10/96→; + ABS		24.2125-1709.3 010499	Ø 25,4
1.6 i 16V	70	05/98→09/00		+ ABS		24.2125-1709.3 010499	Ø 25,4
2.5 24V	125	10/99→09/00					
2.5 ST 200	151	05/99→09/00					
 Bremskraftregler							
1.6 i	66	08/96→09/00		10/96→; - ABS	2	03.6043-1953.3 320201	ATE 3/45 2x
1.8 i	85	08/96→09/00					
1.8 TD	66	08/96→09/00					
2.0 i	96	08/96→09/00					
1.6 i 16V	70	05/98→09/00		- ABS	2	03.6043-1953.3 320201	ATE 3/45 2x
FORD - MONDEO III (B5Y) 10/00→03/07							
 Hauptbremszylinder							
1.8 16V	81 - 92	10/00→03/07		für Fahrzeuge ohne Bremsassistent		24.2123-1779.3 011078	Ø 23,8 ohne Bremsflüssigkeitsbehälter
1.8 SCi	96	06/03→03/07					
2.0 16V	107	10/00→03/07					
2.0 16V DI / TDDi / TDCi	66	10/00→03/07					
2.0 16V TDDi / TDCi	85	10/00→03/07					
2.0 DI	92	10/00→03/07					
2.0 TDCi	96	10/01→03/07					
2.2 TDCi	110 - 114	09/04→03/07					
2.5 V6 24V	125	10/00→03/07					
3.0 V6 24V	150	09/04→03/07					
ST220	166	04/02→03/07					
FORD - MONDEO III Stufenheck (B4Y) 10/00→09/07							
 Hauptbremszylinder							
1.8 16V	81 - 92	10/00→03/07		für Fahrzeuge ohne Bremsassistent		24.2123-1779.3 011078	Ø 23,8 ohne Bremsflüssigkeitsbehälter
1.8 SCi	96	06/03→03/07					
2.0 16V	107	10/00→03/07					
2.0 16V DI / TDDi / TDCi	66	10/00→03/07					
2.0 16V TDDi / TDCi	85	10/00→03/07					
2.0 TDCi	96	10/01→03/07					
2.2 TDCi	110 - 114	09/04→03/07					
2.5 V6	125	10/00→03/07					
2.5 V6 24V	125	10/00→03/07					
3.0 V6 24V	150	09/04→03/07					
ST220	166	04/02→03/07					
2.0 DI	92	10/00→03/07		10/01→; für Fahrzeuge ohne Bremsassistent		24.2123-1779.3 011078	Ø 23,8 ohne Bremsflüssigkeitsbehälter
FORD - MONDEO III Turnier (BWY) 10/00→03/07							
 Hauptbremszylinder							
1.8 16V	81 - 92	10/00→03/07		für Fahrzeuge ohne Bremsassistent		24.2123-1779.3 011078	Ø 23,8 ohne Bremsflüssigkeitsbehälter
1.8 SCi	96	06/03→03/07					
2.0 16V	107	10/00→03/07					
2.0 16V DI / TDDi / TDCi	66	10/00→03/07					
2.0 16V TDDi / TDCi	85	10/00→03/07					
2.0 TDCi	96	10/01→03/07					
2.2 TDCi	110 - 114	09/04→03/07					
2.5 V6 24V	125	10/00→03/07					
3.0 V6 24V	150	09/04→03/07					
ST220	166	04/02→03/07					
FORD - MONDEO IV (BA7) 03/07→01/15							
 Bremskraftverstärker							
1.6 EcoBoost	118	02/11→01/15		→ 09/14		03.7755-1432.4 300300	ATE Ø 9 / 8" pneumatisch
1.6 TDCi	85	02/11→01/15					
1.6 Ti	88	07/10→01/15					
1.8 TDCi	92	06/07→01/15					
2.0 EcoBoost	176	07/10→01/15					
2.0 Flexifuel	107	03/09→01/15					
2.0 LPG	107	07/09→01/15					
2.0 SCTi	149	03/10→01/15					
2.0 TDCi	85 - 120	03/07→01/15					
2.3	118	07/07→01/15					
1.6 Ti	81 - 92	03/07→01/15		04/07→ 09/14		03.7755-1432.4 300300	ATE Ø 9 / 8" pneumatisch
1.8 TDCi	74	03/07→01/15					
→							















	kw			 	! #		
FORD - MONDEO IV (BA7) 03/07→01/15							
 Bremskraftverstärker							
2.0 2.0 TDCi	107 96 - 103	03/07→01/15 03/07→01/15		04/07→ 09/14		03.7755-1432.4 300300	ATE Ø 9 / 8" pneumatisch
2.5 2.2 TDCi	162 129	03/07→01/15 03/08→10/10		04/08→		03.7755-1432.4 300300	ATE Ø 9 / 8" pneumatisch
2.2 TDCi	147	07/10→01/15		11/10→ 09/14		03.7755-1432.4 300300	ATE Ø 9 / 8" pneumatisch
FORD - MONDEO IV Stufenheck (BA7) 03/07→01/15							
 Bremskraftverstärker							
1.6 EcoBoost 1.6 TDCi	118 85	11/10→01/15 12/10→01/15		02/11→ 09/14		03.7755-1432.4 300300	ATE Ø 9 / 8" pneumatisch
1.6 Ti 1.8 TDCi 2.0 2.0 TDCi	81 - 92 74 107 96 - 103	03/07→01/15 03/07→01/15 03/07→01/15 03/07→01/15		04/07→ 09/14		03.7755-1432.4 300300	ATE Ø 9 / 8" pneumatisch
2.5 1.6 Ti 1.8 TDCi 2.0 Flexifuel 2.0 LPG 2.0 SCTi 2.0 TDCi	162 88 92 107 107 149 85 - 120	03/07→01/15 03/10→01/15 06/07→01/15 03/09→01/15 07/09→01/15 03/10→01/15 11/07→01/15		→ 09/14		03.7755-1432.4 300300	ATE Ø 9 / 8" pneumatisch
2.3 2.0 EcoBoost 2.0 TDCi 2.2 TDCi 2.2 TDCi	118 176 100 129 147	07/07→01/15 03/10→09/14 08/08→12/14 03/08→10/10 10/10→01/15		04/08→ 11/10→ 09/14		03.7755-1432.4 300300 03.7755-1432.4 300300	ATE Ø 9 / 8" pneumatisch ATE Ø 9 / 8" pneumatisch
FORD - MONDEO IV Turnier (BA7) 03/07→01/15							
 Bremskraftverstärker							
1.6 EcoBoost 1.6 TDCi 1.6 Ti 2.0 EcoBoost 2.0 Flexifuel 2.0 LPG 2.0 SCTi 2.0 TDCi	118 85 88 176 107 107 149 85 - 120	02/11→01/15 02/11→01/15 07/10→01/15 07/10→01/15 03/09→01/15 07/09→01/15 03/10→01/15 03/07→01/15		→ 09/14		03.7755-1432.4 300300	ATE Ø 9 / 8" pneumatisch
2.3 1.6 Ti 1.8 TDCi 2.0 TDCi 2.5 1.8 TDCi	118 81 - 92 74 96 162 92	07/07→01/15 03/07→12/12 03/07→12/12 03/07→12/12 03/07→12/12 06/07→12/12		04/07→		03.7755-1432.4 300300	ATE Ø 9 / 8" pneumatisch
2.0 2.0 TDCi 2.2 TDCi 2.2 TDCi	107 103 129 147	03/07→01/15 03/07→01/15 03/08→10/10 07/10→01/15		04/07→ 09/14 04/08→ 11/10→ 09/14		03.7755-1432.4 300300 03.7755-1432.4 300300	ATE Ø 9 / 8" pneumatisch ATE Ø 9 / 8" pneumatisch
FORD - MONDEO IV Van 03/07→01/15							
 Bremskraftverstärker							
1.6 EcoBoost 1.6 TDCi 2.0 EcoBoost	118 85 149 - 176	11/10→09/14 03/13→09/14 03/10→09/14				03.7755-1432.4 300300	ATE Ø 9 / 8" pneumatisch
2.0 TDCi 2.2 TDCi	85 - 120 147	11/07→09/14 03/13→09/14					
2.0 2.0 TDCi	107 103	03/07→09/14 03/07→09/14		04/07→		03.7755-1432.4 300300	ATE Ø 9 / 8" pneumatisch
FORD - PUMA (EC_) 03/97→06/02							
 Hauptbremszylinder							
1.4 16V 1.6 16V	66 76	11/97→10/00 08/00→06/02		02/00→; + ABS → 12/01; + ABS		03.2123-2243.3 010748 03.2123-2243.3 010748	ATE Ø 23,8 ATE Ø 23,8
1.7 16V	92	03/97→06/02		02/00→ 12/01; + ABS		03.2123-2243.3 010748	ATE Ø 23,8















	kw					! #		
FORD - RANGER (ET) 01/05→07/12								
 Hauptbremszylinder								
2.2	68	06/07→01/09					24.2125-1747.3 011029	Ø 25,4
2.5 TDCi 4x4	105	05/06→07/12						
3.0 TDCi 4x4	115	05/06→07/12						
2.5 TDi	105	05/06→07/12		04/10→ 10/11			24.2125-1747.3 011029	Ø 25,4
2.5 TDi 4x4	80	06/07→07/12						
3.0 TDCi	115	05/06→07/12						
FORD - S-MAX (WA6) 05/06→12/14								
 Bremskraftverstärker								
1.6 EcoBoost	118	02/11→12/14					03.7755-1432.4 300300	ATE Ø 9 / 8" pneumatisch
1.6 TDCi	85	02/11→12/14						
1.8 TDCi	74 - 92	05/06→12/14						
2.0	107	05/06→12/14						
2.0 EcoBoost	146 - 176	03/10→12/14						
2.0 Flexifuel	107	05/06→12/14						
2.0 TDCi	85 - 120	05/06→12/14						
2.2 TDCi	147	07/10→12/14						
2.3	118	07/07→12/14						
2.5 ST	162	05/06→12/14						
2.2 TDCi	129	03/08→12/12		04/08→			03.7755-1432.4 300300	ATE Ø 9 / 8" pneumatisch
FORD - S-MAX VAN (WA6) 05/06→12/14								
 Bremskraftverstärker								
1.6	118	02/11→12/14					03.7755-1432.4 300300	ATE Ø 9 / 8" pneumatisch
2.0	107	03/10→12/14						
2.0 EcoBoost	149 - 176	03/10→12/14						
2.0 TDCi	85 - 120	01/07→12/14						
FORD - TOURNEO CONNECT / GRAND TOURNEO CONNECT V408 Großraumlimousi 09/13→								
 Hauptbremszylinder								
1.0 EcoBoost	74	11/13→		für verkürzten Radstand			03.4155-5451.3 010995	ATE Ø 25,4
1.6 EcoBoost	110	11/13→		für verlängerten Radstand			03.4155-5456.3 010996	ATE Ø 25,4
1.6 TDCi	55 - 85	09/13→						
FORD - TOURNEO COURIER B460 Großraumlimousine 02/14→								
 Hauptbremszylinder								
1.0 EcoBoost	74	02/14→		für Linkslenker; + ABS			24.4120-1710.3 011082	Ø 20,6 ohne Bremsflüssigkeitsbehälter
1.5 TDCi	55	02/14→		für Linkslenker; - ABS			24.4120-1711.3 011093	Ø 20,6 ohne Bremsflüssigkeitsbehälter
1.5 EcoBlue	74	04/18→		+ ABS			24.4120-1710.3 011082	Ø 20,6 ohne Bremsflüssigkeitsbehälter
1.5 TDCi	70	05/15→		für Linkslenker; - ABS			24.4120-1711.3 011093	Ø 20,6 ohne Bremsflüssigkeitsbehälter
1.6 TDCi	70	02/14→		für Rechtslenker; + ABS			24.4120-1710.3 011082	Ø 20,6 ohne Bremsflüssigkeitsbehälter
				für Linkslenker; - ABS			24.4120-1711.3 011093	Ø 20,6 ohne Bremsflüssigkeitsbehälter
FORD - TRANSIT Bus (E_) 06/94→07/00								
 Hauptbremszylinder								
2.0	84	08/94→03/00		→ 03/97; - ABS			24.2123-1724.3 010566	BDX Ø 23,8
2.5 DI	51 - 56	07/94→03/00		04/97→; + ABS			24.2123-1742.3 010671	Ø 23,8
2.5 TD	63 - 74	07/94→03/00		04/97→; - ABS			24.2123-1749.3 010713	Ø 23,8
2.0 CNG	84	06/94→03/00		07/94→ 03/97; - ABS			24.2123-1724.3 010566	BDX Ø 23,8
				→ 03/97; - ABS			24.2123-1724.3 010566	BDX Ø 23,8
				04/97→; + ABS			24.2123-1742.3 010671	Ø 23,8
				04/97→; - ABS			24.2123-1749.3 010713	Ø 23,8
2.5 DI	85	08/97→03/00		+ ABS			24.2123-1742.3 010671	Ø 23,8
				- ABS			24.2123-1749.3 010713	Ø 23,8
2.5 TD	55	08/94→06/00		→ 03/97; - ABS			24.2123-1724.3 010566	BDX Ø 23,8
				04/97→ 03/00; + ABS			24.2123-1742.3 010671	Ø 23,8
				04/97→ 03/00; - ABS			24.2123-1749.3 010713	Ø 23,8















	kW					! #		
FORD - TRANSIT Bus (FD_, FB_, FS_, FZ_, FC_) 01/00→05/06								
 Hauptbremszylinder								
2.0 DI	55 - 74	08/00→05/06		- ABS			24.2125-1721.3 010673	Ø 25,4 ohne Bremsflüssigkeitsbehälter
2.0 TDCi	92	08/02→05/06		+ ABS			24.2125-1722.3 010674	Ø 25,4 ohne Bremsflüssigkeitsbehälter
2.3 16V RWD	107	08/00→05/06						
2.4 DI	66	01/00→05/06						
2.4 DI RWD	55 - 88	01/00→05/06						
2.4 TDCi	101	03/04→05/06						
2.4 TDE	85 - 92	07/01→05/06						
FORD - TRANSIT Bus (FD_, FB_, FS_, FZ_, FC_) 04/06→12/14								
 Hauptbremszylinder								
2.2 TDCi	63	04/06→08/14		05/06→; + ABS			24.4125-1708.3 011055	Ø 25,4 ohne Bremsflüssigkeitsbehälter
2.2 TDCi	74 - 103	04/06→08/14		+ ABS			24.4125-1708.3 011055	Ø 25,4 ohne Bremsflüssigkeitsbehälter
2.2 TDCi RWD	74 - 114	09/11→12/14						
2.4 TDCi	74 - 103	04/06→08/14						
2.4 TDCi 4x4	103	11/06→08/14						
3.2 TDCi	147	02/08→08/14						
FORD - TRANSIT CONNECT Großraumlimousine 02/13→								
 Hauptbremszylinder								
1.6 TDCi	55 - 85	02/13→		für verkürzten Radstand			03.4155-5451.3 010995	ATE Ø 25,4
				für verlängerten Radstand			03.4155-5456.3 010996	ATE Ø 25,4
FORD - TRANSIT CONNECT V408 Kasten/Großraumlimousine 02/13→								
 Hauptbremszylinder								
1.0 EcoBoost	74	02/13→		09/13→; für verkürzten Radstand			03.4155-5451.3 010995	ATE Ø 25,4
				09/13→; für verlängerten Radstand			03.4155-5456.3 010996	ATE Ø 25,4
1.6 EcoBoost	110	11/13→		für verkürzten Radstand			03.4155-5451.3 010995	ATE Ø 25,4
1.6 TDCi	55 - 85	02/13→		für verlängerten Radstand			03.4155-5456.3 010996	ATE Ø 25,4
FORD - TRANSIT COURIER B460 Großraumlimousine 02/14→								
 Hauptbremszylinder								
1.0 EcoBoost	74	02/14→		+ ABS			24.4120-1710.3 011082	Ø 20,6 ohne Bremsflüssigkeitsbehälter
1.5 EcoBlue	74	04/18→						
1.5 TDCi	55 - 70	02/14→		für Linkslenker; - ABS			24.4120-1711.3 011093	Ø 20,6 ohne Bremsflüssigkeitsbehälter
1.6 TDCi	70	02/14→						
FORD - TRANSIT COURIER B460 Kasten/Großraumlimousine 02/14→								
 Hauptbremszylinder								
1.0 EcoBoost	74	02/14→		+ ABS			24.4120-1710.3 011082	Ø 20,6 ohne Bremsflüssigkeitsbehälter
1.5 EcoBlue	74	04/18→						
1.5 TDCi	55 - 70	02/14→		für Linkslenker; - ABS			24.4120-1711.3 011093	Ø 20,6 ohne Bremsflüssigkeitsbehälter
1.6 TDCi	70	02/14→						
FORD - TRANSIT Kasten (E_) 06/94→12/00								
 Hauptbremszylinder								
2.0	84	06/94→03/00		→ 03/97; - ABS			24.2123-1724.3 010566	BDX Ø 23,8
2.5 DI	51 - 56	06/94→03/00		04/97→; + ABS			24.2123-1742.3 010671	Ø 23,8
2.5 TD	63	06/94→03/00		04/97→; - ABS			24.2123-1749.3 010713	Ø 23,8
2.5 TDI	74	06/94→03/00						
2.5 DI	85	05/99→03/00		+ ABS			24.2123-1742.3 010671	Ø 23,8
2.5 TD	55	06/94→03/00		- ABS			24.2123-1749.3 010713	Ø 23,8
FORD - TRANSIT Kasten (FA_) 04/06→12/14								
 Hauptbremszylinder								
2.2 TDCi	63 - 103	04/06→08/14		+ ABS			24.4125-1708.3 011055	Ø 25,4 ohne Bremsflüssigkeitsbehälter
2.2 TDCi 4x4	92	10/11→08/14						
2.2 TDCi RWD	74 - 114	09/11→12/14						
2.3 16V CNG RWD	100	04/06→08/14						
2.3 16V LPG RWD	107	04/06→08/14						













	kw					! #		
FORD - TRANSIT Kasten (FA_) 04/06→12/14								
 Hauptbremszylinder								
2.3 16V RWD	107	04/06→08/14		+ ABS		24.4125-1708.3	011055	Ø 25,4 ohne Bremsflüssigkeitsbehälter
2.4 TDCi 4x4	103	11/06→08/14						
2.4 TDCi RWD	74 - 103	04/06→08/14						
3.2 TDCi RWD	147	09/07→08/14						
FORD - TRANSIT Kasten (FA_) 01/00→05/06								
 Hauptbremszylinder								
2.0 DI	55 - 74	08/00→05/06		- ABS		24.2125-1721.3	010673	Ø 25,4 ohne Bremsflüssigkeitsbehälter
2.0 TDCi	92	08/02→05/06		+ ABS		24.2125-1722.3	010674	Ø 25,4 ohne Bremsflüssigkeitsbehälter
2.3	105	03/01→03/06						
2.3 16V RWD	107	04/01→05/06						
2.3 BiFuel	105	03/01→03/06						
2.4 DI	66	01/00→05/06						
2.4 DI RWD	55 - 88	01/00→05/06						
2.4 TD	55	08/00→08/03						
2.4 TDCi	101	03/04→05/06						
2.4 TDE	85 - 92	07/01→05/06						
FORD - TRANSIT Pritsche/Fahrgestell (E_) 08/94→07/00								
 Hauptbremszylinder								
2.0	84	08/94→03/00		→ 03/97; - ABS		24.2123-1724.3	010566	BDX Ø 23,8
2.5 DI	51 - 56	08/94→03/00		04/97→; + ABS		24.2123-1742.3	010671	Ø 23,8
2.5 TD	63 - 74	08/94→03/00		04/97→; - ABS		24.2123-1749.3	010713	Ø 23,8
2.5 DI	85	05/99→03/00		+ ABS		24.2123-1742.3	010671	Ø 23,8
				- ABS		24.2123-1749.3	010713	Ø 23,8
FORD - TRANSIT Pritsche/Fahrgestell (FM_ , FN_ , FF_) 04/06→12/14								
 Hauptbremszylinder								
2.2 TDCi	63 - 103	04/06→08/14		+ ABS		24.4125-1708.3	011055	Ø 25,4 ohne Bremsflüssigkeitsbehälter
2.2 TDCi 4x4	92	10/11→08/14						
2.2 TDCi RWD	74 - 114	10/11→08/14						
2.3 16V CNG RWD	100	04/06→08/14						
2.3 16V LPG RWD	107	04/06→08/14						
2.3 16V RWD	107	04/06→08/14						
2.4 TDCi 4x4	103	11/06→08/14						
2.4 TDCi RWD	74 - 103	04/06→08/14						
3.2 TDCi RWD	147	09/07→08/14						
FORD - TRANSIT Pritsche/Fahrgestell (FM_ , FN_) 01/00→05/06								
 Hauptbremszylinder								
2.0 DI	55 - 74	08/00→05/06		- ABS		24.2125-1721.3	010673	Ø 25,4 ohne Bremsflüssigkeitsbehälter
2.0 TDCi	92	08/02→05/06		+ ABS		24.2125-1722.3	010674	Ø 25,4 ohne Bremsflüssigkeitsbehälter
2.3 16V	107	04/01→05/06						
2.3 BiFuel	105	03/01→03/06						
2.4 DI	55 - 88	01/00→05/06						
2.4 TDCi	101	03/04→05/06						
2.4 TDE	85 - 92	07/01→05/06						
FORD - TRANSIT TOURNEO Bus 08/94→12/00								
 Hauptbremszylinder								
2.0	84	11/94→12/00		09/95→ 03/97; - ABS		24.2123-1724.3	010566	BDX Ø 23,8
				04/97→ 03/00; + ABS		24.2123-1742.3	010671	Ø 23,8
				04/97→ 03/00; - ABS		24.2123-1749.3	010713	Ø 23,8
2.4 D	55	08/94→06/00		→ 03/97; - ABS		24.2123-1724.3	010566	BDX Ø 23,8
2.5 DI	51 - 56	11/94→12/00		04/97→ 03/00; + ABS		24.2123-1742.3	010671	Ø 23,8
				04/97→ 03/00; - ABS		24.2123-1749.3	010713	Ø 23,8
2.5 TD	63	11/94→12/00		01/95→ 03/97; - ABS		24.2123-1724.3	010566	BDX Ø 23,8
				04/97→ 03/00; + ABS		24.2123-1742.3	010671	Ø 23,8
				04/97→ 03/00; - ABS		24.2123-1749.3	010713	Ø 23,8
2.5 TD	74	04/98→12/00		→ 03/00; + ABS		24.2123-1742.3	010671	Ø 23,8
				→ 03/00; - ABS		24.2123-1749.3	010713	Ø 23,8













	kw					! #		
FORD - TRANSIT TOURNEO Bus 07/06→08/14								
 Hauptbremszylinder								
2.2 2.2 TDCi	92 81 - 103	10/11→08/14 07/06→08/14		+ ABS		24.4125-1708.3	011055	Ø 25,4 ohne Bremsflüssigkeitsbehälter
FORD - TRANSIT TOURNEO Bus (FC_ _) 06/00→03/06								
 Hauptbremszylinder								
2.0	55 - 92	06/00→03/06		- ABS		24.2125-1721.3	010673	Ø 25,4 ohne Bremsflüssigkeitsbehälter
				+ ABS		24.2125-1722.3	010674	Ø 25,4 ohne Bremsflüssigkeitsbehälter
FSO - 126P 07/72→09/00								
 Hauptbremszylinder								
650	18	07/81→09/00		→ 07/90		24.2119-0815.3	010347	Ø 19
HONDA - ACCORD VII (CL, CN) 01/03→09/12								
 Hauptbremszylinder								
2.0 2.4	110 113	01/06→03/08 09/06→05/08		für Linkslenker		24.2120-1752.3	010928	ATE Ø 20,6 mit Bremsflüssigkeitsbehälter
2.0 2.4 2.4 i 16V	114 140 115	02/03→05/08 02/03→05/08 02/03→05/08		01/06→; für Linkslenker		24.2120-1752.3	010928	ATE Ø 20,6 mit Bremsflüssigkeitsbehälter
2.0 All-wheel Drive 2.2 i-CTDi	114 103	02/03→05/08 01/04→05/08		01/06→		24.2120-1752.3	010928	ATE Ø 20,6 mit Bremsflüssigkeitsbehälter
HONDA - ACCORD VII Tourer (CM, CN) 04/03→05/08								
 Hauptbremszylinder								
2.0 2.2 i-CTDi 2.4 2.4 Vtec T	114 103 140 147	04/03→05/08 01/04→05/08 04/03→05/08 09/03→05/08		01/06→		24.2120-1752.3	010928	ATE Ø 20,6 mit Bremsflüssigkeitsbehälter
HONDA - CIVIC VI Coupe (EJ, EM1) 03/96→12/00								
 Hauptbremszylinder								
1.6 1.6 i	79 77	05/96→04/99 03/96→03/00		→ 12/98; - ABS		24.2120-1751.3	010909	Ø 20,6
HONDA - CIVIC VI Hatchback (EJ, EK) 10/95→03/01								
 Hauptbremszylinder								
1.4 i 1.4 i S 1.4 LPG	55 66 66	11/95→02/01 11/95→02/01 01/97→02/01		→ 01/01; - ABS; für Linkslenker		24.2120-1751.3	010909	Ø 20,6
HONDA - CIVIC VI Stufenheck (EJ, EK, SO) 06/95→03/01								
 Hauptbremszylinder								
1.4 i	66	11/95→02/01		→ 01/01; - ABS; für Linkslenker		24.2120-1751.3	010909	Ø 20,6
HONDA - CIVIC VIII Hatchback (FN, FK) 09/05→12/12								
 Hauptbremszylinder								
1.4 1.8 2.2 CTDi Type R	61 103 103 148	09/05→09/08 09/05→12/11 09/05→12/11 09/06→01/12		für Linkslenker		24.2120-1759.3	011083	Ø 20,6 ohne Bremsflüssigkeitsbehälter
HYUNDAI - ATOS (MX) 01/97→								
 Hauptbremszylinder								
1.1	43	08/03→12/08		→ 08/08; + ABS		24.2120-1767.3	011004	Ø 20,6 ohne Bremsflüssigkeitsbehälter
1.1	45	06/03→12/10		→ 01/07; + ABS; für Linkslenker		24.2120-1767.3	011004	Ø 20,6 ohne Bremsflüssigkeitsbehälter
1.1	46	08/03→12/08		03/04→ 02/08; + ABS		24.2120-1767.3	011004	Ø 20,6 ohne Bremsflüssigkeitsbehälter
HYUNDAI - GETZ (TB) 06/01→01/11								
 Hauptbremszylinder								
1.1 1.6	46 77	09/02→09/05 09/02→09/05		→ 07/05; - ABS		24.2122-1761.3	010822	Ø 22,2
				→ 07/05; + ABS		24.2122-1765.3	010839	Ø 22,2
→								













	kw			 	! #		
HYUNDAI - GETZ (TB) 06/01→01/11							
 Hauptbremszylinder							
1.1 1.4 i 1.5 CRDi 1.5 CRDi GLS	49 71 65 81	09/05→06/09 08/05→12/10 08/05→06/09 08/05→06/09		→ 02/09; - ESP		24.2122-1765.3 010839	Ø 22,2
1.3	61 - 63	09/03→06/09		→ 04/05; - ABS		24.2122-1761.3 010822	Ø 22,2
1.5 i	73	03/03→09/05		→ 04/05; + ABS		24.2122-1765.3 010839	Ø 22,2
1.3 i	60	09/02→03/04		- ABS		24.2122-1761.3 010822	Ø 22,2
				+ ABS		24.2122-1765.3 010839	Ø 22,2
1.5 CRDi	60	03/03→09/05		→ 04/05; - ESP		24.2122-1765.3 010839	Ø 22,2
1.5 CRDi GLS	75	07/04→08/05		→ 07/05; - ESP		24.2122-1765.3 010839	Ø 22,2
1.6	78	06/05→06/09		08/05→; - ESP		24.2122-1765.3 010839	Ø 22,2
HYUNDAI - i10 I (PA) 10/07→							
 Hauptbremszylinder							
1.2	64	12/15→		für Linkslenker		24.4120-1713.3 011102	Ø 20,6 ohne Bremsflüssigkeitsbehälter
HYUNDAI - i10 II (BA, IA) 08/13→							
 Hauptbremszylinder							
1.0	49	08/13→		12/13→; für Linkslenker		24.4120-1713.3 011102	Ø 20,6 ohne Bremsflüssigkeitsbehälter
1.0 LPG	49 - 51	02/14→		für Linkslenker		24.4120-1713.3 011102	Ø 20,6 ohne Bremsflüssigkeitsbehälter
1.2	64	12/13→					
HYUNDAI - i10 II Stufenheck 12/13→							
 Hauptbremszylinder							
1.2	64	08/15→		für Linkslenker		24.4120-1713.3 011102	Ø 20,6 ohne Bremsflüssigkeitsbehälter
HYUNDAI - i30 (GD) 06/11→							
 Hauptbremszylinder							
1.4	73 - 74	12/11→12/16		für Rechtslenker; + ABS / - ESP		24.4122-1724.3 011080	ATE Ø 22,2 ohne Bremsflüssigkeitsbehälter
1.4 CRDi	66	12/11→12/16		für Linkslenker; + ABS / - ESP		24.4122-1724.3 011080	ATE Ø 22,2 ohne Bremsflüssigkeitsbehälter
1.4 LPG	73	01/13→					
1.6	88 - 96	12/11→		für Linkslenker; + ABS / + ESP		24.4122-1732.3 011107	Ø 22,2 ohne Bremsflüssigkeitsbehälter
1.6 CRDi	94 - 100	11/11→12/16					
1.6 GDI	99	12/11→12/16					
1.6 T-GDI	137	01/15→					
1.8	110	01/12→					
1.6 CRDi	81	12/11→12/16		06/12→; für Linkslenker; + ABS / - ESP		24.4122-1724.3 011080	ATE Ø 22,2 ohne Bremsflüssigkeitsbehälter
				für Rechtslenker; + ABS / - ESP		24.4122-1724.3 011080	ATE Ø 22,2 ohne Bremsflüssigkeitsbehälter
				06/12→; für Linkslenker; + ABS / + ESP		24.4122-1732.3 011107	Ø 22,2 ohne Bremsflüssigkeitsbehälter
HYUNDAI - i30 Coupe 05/13→							
 Hauptbremszylinder							
1.4	73 - 74	05/13→		für Linkslenker; + ABS / - ESP		24.4122-1724.3 011080	ATE Ø 22,2 ohne Bremsflüssigkeitsbehälter
1.6 CRDi	81 - 100	05/13→		für Rechtslenker; + ABS / - ESP		24.4122-1724.3 011080	ATE Ø 22,2 ohne Bremsflüssigkeitsbehälter
1.6 GDI	99	05/13→					
1.6 T-GDI	137	01/15→		für Linkslenker; + ABS / + ESP		24.4122-1732.3 011107	Ø 22,2 ohne Bremsflüssigkeitsbehälter
1.4 CRDi	66	05/13→		für Linkslenker; - ESP		24.4122-1724.3 011080	ATE Ø 22,2 ohne Bremsflüssigkeitsbehälter
				für Rechtslenker; - ESP		24.4122-1724.3 011080	ATE Ø 22,2 ohne Bremsflüssigkeitsbehälter
				für Linkslenker; + ESP		24.4122-1732.3 011107	Ø 22,2 ohne Bremsflüssigkeitsbehälter
HYUNDAI - i30 Hatchback Van (GDE) 06/12→							
 Hauptbremszylinder							
1.4 MPI	74	05/15→		für Linkslenker; + ABS / - ESP		24.4122-1724.3 011080	ATE Ø 22,2 ohne Bremsflüssigkeitsbehälter
1.6 CRDi	81	05/15→					
→							

	kw					! #		
HYUNDAI - i30 Hatchback Van (GDE) 06/12→								
 Hauptbremszylinder								
1.6 GDI	99	05/15→		für Rechtslenker; + ABS / - ESP		24.4122-1724.3	011080	ATE Ø 22,2 ohne Bremsflüssigkeitsbehälter
				für Linkslenker; + ABS / + ESP		24.4122-1732.3	011107	Ø 22,2 ohne Bremsflüssigkeitsbehälter
HYUNDAI - i30 Kombi (GD) 06/12→								
 Hauptbremszylinder								
1.4	73 - 74	06/12→		für Rechtslenker; - ESP		24.4122-1724.3	011080	ATE Ø 22,2 ohne Bremsflüssigkeitsbehälter
1.4 CRDi	66	06/12→		für Linkslenker; - ESP		24.4122-1724.3	011080	ATE Ø 22,2 ohne Bremsflüssigkeitsbehälter
1.6	88 - 95	06/12→						
1.6 CRDi	81 - 100	06/12→		für Linkslenker; + ESP		24.4122-1732.3	011107	Ø 22,2 ohne Bremsflüssigkeitsbehälter
1.6 GDI	99	06/12→						
HYUNDAI - i30 Kombi Van (GDE, GD) 06/12→								
 Hauptbremszylinder								
1.4 MPI	74	05/15→		für Linkslenker; - ESP		24.4122-1724.3	011080	ATE Ø 22,2 ohne Bremsflüssigkeitsbehälter
				für Rechtslenker; - ESP		24.4122-1724.3	011080	ATE Ø 22,2 ohne Bremsflüssigkeitsbehälter
				für Linkslenker; + ESP		24.4122-1732.3	011107	Ø 22,2 ohne Bremsflüssigkeitsbehälter
1.6 CRDi	81	05/15→		für Linkslenker; für Fahrzeuge ohne Start-Stopp-Funktion		24.4122-1724.3	011080	ATE Ø 22,2 ohne Bremsflüssigkeitsbehälter
1.6 GDI	99	05/15→						
				für Linkslenker; für Fahrzeuge mit Start-Stopp-Funktion		24.4122-1732.3	011107	Ø 22,2 ohne Bremsflüssigkeitsbehälter
HYUNDAI - i40 I (VF) 03/12→05/19								
 Hauptbremszylinder								
1.6 CRDi	85 - 100	07/18→05/19		für Linkslenker		24.4123-1737.3	011119	Ø 23,8 ohne Bremsflüssigkeitsbehälter
1.6 GDI	99	03/12→05/19						
1.7 CRDi	85 - 100	03/12→05/19						
1.7 CRDi	103 - 104	10/12→05/19						
2.0 GDi	121	12/14→05/19						
2.0 GDI	130 - 131	03/12→05/19						
2.0 CVVT	110 - 130	03/12→05/19		für Linkslenker; - RU		24.4123-1737.3	011119	Ø 23,8 ohne Bremsflüssigkeitsbehälter
HYUNDAI - i40 I CW (VF) 07/11→05/19								
 Hauptbremszylinder								
1.6 CRDi	85 - 100	07/18→05/19		für Linkslenker		24.4123-1737.3	011119	Ø 23,8 ohne Bremsflüssigkeitsbehälter
1.6 GDI	99	07/11→05/19						
1.7 CRDi	85 - 104	07/11→05/19						
2.0 CVVT	121 - 130	07/11→05/19						
2.0 GDi	121	12/14→05/19						
2.0 GDI	130	07/11→05/19						
2.0 CVVT	110	10/12→05/19		für Linkslenker; - RU		24.4123-1737.3	011119	Ø 23,8 ohne Bremsflüssigkeitsbehälter
HYUNDAI - i40 I Kombi Van (VF) 07/11→05/19								
 Hauptbremszylinder								
1.7 CRDi	85	05/15→05/19		für Linkslenker		24.4123-1737.3	011119	Ø 23,8 ohne Bremsflüssigkeitsbehälter
HYUNDAI - ix20 (JC) 11/10→07/19								
 Hauptbremszylinder								
1.4	66	11/10→07/19		+ ESP		24.4122-1725.3	011087	Ø 22,2 ohne Bremsflüssigkeitsbehälter
1.4 CRDi	57 - 66	11/10→07/19						
1.4 LPG	66	11/10→07/19		- ESP		24.4122-1736.3	011129	Ø 22,2 ohne Bremsflüssigkeitsbehälter
1.6	92	11/10→07/19						
1.6 CRDi	85 - 94	06/11→07/19						
1.6 LPG	92	11/10→07/19						
→								













	kw			 	! #		
HYUNDAI - ix20 (JC) 11/10→07/19							
 Hauptbremszylinder							
1.4	74	11/10→07/19		für Linkslenker; + ESP		24.4122-1725.3 011087	Ø 22,2 ohne Bremsflüssigkeitsbehälter
				für Linkslenker; - ESP		24.4122-1736.3 011129	Ø 22,2 ohne Bremsflüssigkeitsbehälter
HYUNDAI - ix35 (LM, EL, ELH) 08/09→10/16							
 Hauptbremszylinder							
1.6	99	11/10→12/15		für Linkslenker; + ESP		24.4122-1723.3 011086	Ø 22,2 ohne Bremsflüssigkeitsbehälter
1.7 CRDi	85	11/10→12/15					
2.0	113 - 122	01/10→12/15					
2.0 4WD	113 - 120	01/10→12/15					
2.0 CRDi	100 - 135	01/10→12/15					
2.0 CRDi 4WD	100 - 135	01/10→12/15					
2.0 CVVT	110	08/09→12/15					
2.0 CVVT 4WD	110 - 122	08/09→12/15					
2.0 CVVT AWD	110	08/09→07/13					
2.0 GDi	122	08/13→12/15					
2.0 GDi 4WD	122	08/13→12/15					
2.4 DCVVT-I 4WD	128	07/10→12/13					
2.4 4WD	129 - 130	01/10→12/15		für Linkslenker; für Fahrzeuge mit Bremsassistent		24.4122-1723.3 011086	Ø 22,2 ohne Bremsflüssigkeitsbehälter
HYUNDAI - ix35 Van 08/09→12/15							
 Hauptbremszylinder							
CRDi	85 - 100	08/09→12/15		für Linkslenker; + ESP		24.4122-1723.3 011086	Ø 22,2 ohne Bremsflüssigkeitsbehälter
CRDi 4WD	100	08/09→12/15					
GDi	99	05/15→12/15					
HYUNDAI - MATRIX (FC) 06/01→08/10							
 Hauptbremszylinder							
1.5 CRDi	60	10/01→08/10		→ 07/03; - ABS		24.2123-1762.3 010823	Ø 23,8
1.6	66 - 76	06/01→08/10					
1.8	90	06/01→08/10		→ 07/03		24.2123-1762.3 010823	Ø 23,8
HYUNDAI - TUCSON (TL, TLE) 05/15→04/22							
 Hauptbremszylinder							
1.6 GDi	96 - 97	06/15→09/20		für Linkslenker; - ESP		24.4122-1724.3 011080	ATE Ø 22,2 ohne Bremsflüssigkeitsbehälter
1.6 T-GDi	130	06/15→09/20		für Linkslenker; + ESP		24.4122-1732.3 011107	Ø 22,2 ohne Bremsflüssigkeitsbehälter
1.6 T-GDi All-wheel Drive	130	06/15→09/20					
1.7 CRDi	85 - 104	06/15→09/20					
2.0	115	06/15→09/20					
2.0 CRDi	100	06/15→09/20		für Linkslenker; Fahrzeugproduktionsland Tschechische Republik; - ESP		24.4122-1724.3 011080	ATE Ø 22,2 ohne Bremsflüssigkeitsbehälter
2.0 CRDi All-wheel Drive	100 - 136	06/15→09/20		für Linkslenker; Fahrzeugproduktionsland Tschechische Republik; + ESP		24.4122-1732.3 011107	Ø 22,2 ohne Bremsflüssigkeitsbehälter
2.0 CVVT All-wheel Drive	110	06/15→09/20		- ESP		24.4122-1724.3 011080	ATE Ø 22,2 ohne Bremsflüssigkeitsbehälter
				+ ESP		24.4122-1732.3 011107	Ø 22,2 ohne Bremsflüssigkeitsbehälter
HYUNDAI - VELOSTER (FS) 03/11→12/17							
 Hauptbremszylinder							
1.6	94	06/11→12/17		für Linkslenker; + ESP		24.4122-1732.3 011107	Ø 22,2 ohne Bremsflüssigkeitsbehälter
1.6 GDi	95	10/11→12/17					
1.6 GDI	103	03/11→12/17					
1.6 MPI	97	04/11→12/17					
1.6 T-GDI	137 - 150	08/12→12/17					
JAGUAR - S-TYPE II (X200) 10/98→12/08							
 Bremskraftverstärker							
2.7 D →	152	06/04→10/07				03.7745-6502.4 300296	ATE Ø 8" pneumatisch

















	kw			 	! #		
JAGUAR - S-TYPE II (X200) 10/98→12/08							
Pedalwegsensord, Bremspedal							
2.5 V6	147	04/02→10/07		02/03→		03.0655-0007.2 370007	ATE
4.2 V8	219	04/02→10/07					
2.7 D	152	06/04→10/07				03.0655-0007.2 370007	ATE
3.0 V6	175	01/99→10/07		05/03→		03.0655-0007.2 370007	ATE
4.2 Supercharged R 4	298	11/01→12/08		08/03→		03.0655-0007.2 370007	ATE
2 V8	291	04/02→10/07					
 Hauptbremszylinder							
2.5 V6	147	04/02→10/07		M45255→ N52047; für Linkslenker; + ESP		03.4125-0032.3 010955	ATE Ø 25,4
2.7 D	152	06/04→10/07					
3.0 V6	175	01/99→10/07		N52048→; für Linkslenker; + ESP		24.4156-1051.3 011069	ATE Ø 27 ohne Bremsflüssigkeitsbehälter
4.0 V8	203 - 209	01/99→12/02					
4.2 Supercharged	298	11/01→12/08					
4.2 V8	219	04/02→10/07					
R 4	291	04/02→10/07					
2 V8	291	04/02→10/07					
JAGUAR - XF I (X250) 03/08→04/15							
 Bremskraftverstärker							
2.0	177	06/12→04/15				03.7745-6502.4 300296	ATE Ø 8" pneumatisch
2.2 D	120 - 147	04/11→04/15					
2.7 D	152	03/08→04/15					
3.0	250	03/12→04/15					
3.0 AWD	250	10/12→04/15					
3.0 D	155 - 202	03/09→04/15					
4.2	219	03/08→04/15					
4.2 Kompressor	306	03/08→04/15					
5.0	283	03/09→04/15					
 Hauptbremszylinder							
2.0	177	06/12→04/15		für Linkslenker		24.4156-1016.3 011068	ATE Ø 27
2.2 D	120 - 147	04/11→04/15					
2.7 D	152	03/08→04/15					
3.0	175 - 250	03/08→04/15					
3.0 AWD	250	10/12→04/15					
3.0 D	155 - 202	03/09→04/15					
4.2	219	03/08→04/15					
4.2 Kompressor	306	03/08→04/15					
5.0	283	03/09→04/15					
5.0 Kompressor	346 - 375	01/09→04/15					
5.0 XFR-S	405	10/12→04/15					
JAGUAR - XF SPORTBRAKE (X250) 09/12→12/15							
 Bremskraftverstärker							
2.0 T	177	08/13→12/15				03.7745-6502.4 300296	ATE Ø 8" pneumatisch
2.2 D	120 - 147	09/12→04/14					
 Hauptbremszylinder							
2.0 T	177	08/13→12/15		für Linkslenker		24.4156-1016.3 011068	ATE Ø 27
2.2 D	120 - 147	09/12→04/14					
3.0 D	177 - 202	09/12→04/14					
5.0 XFR-S	405	02/13→04/14		02/14→; für Linkslenker		24.4156-1016.3 011068	ATE Ø 27
JAGUAR - XJ (X350, X358) 03/03→03/09							
Pedalwegsensord, Bremspedal							
3.0	175 - 179	05/03→03/09		für Rechtslenker		03.0655-0007.2 370007	ATE
3.6	190	05/03→03/09				03.0655-0007.2 370007	ATE
4.2	219	05/03→03/09					
R 4.2	291	03/03→03/09		05/03→		03.0655-0007.2 370007	ATE
 Hauptbremszylinder							
3.0	175 - 179	05/03→03/09		für Linkslenker		03.4125-0032.3 010955	ATE Ø 25,4
3.6 →	190	05/03→03/09					















	kw					! #		
JAGUAR - XJ (X350, X358) 03/03→03/09								
 Hauptbremszylinder								
4.2	219	05/03→03/09			für Linkslenker		03.4125-0032.3 010955	ATE Ø 25,4
D 2.7	152	10/05→03/09			→ G49700; für Linkslenker		03.4125-0032.3 010955	ATE Ø 25,4
					H17287→; für Linkslenker		24.4156-1051.3 011069	ATE Ø 27 ohne Bremsflüssigkeitsbehälter
					G49701→ H17286; für Linkslenker		24.4156-1051.3 011069	ATE Ø 27 ohne Bremsflüssigkeitsbehälter
R 4.2	291	03/03→03/09			05/03→; für Linkslenker		03.4125-0032.3 010955	ATE Ø 25,4
JAGUAR - XJ (X351) 10/09→								
 Hauptbremszylinder								
2.0 Ti4	177	05/12→			für Linkslenker		24.4156-1076.3 011070	ATE Ø 27 ohne Bremsflüssigkeitsbehälter
3.0 SCV6	250	03/12→						
3.0 SCV6 AWD	250	10/12→						
3.0 SDV6	202 -	10/09→						
	221							
3.0 V6	175	01/11→						
5.0 SCV8	346 -	10/09→						
	405							
5.0 V8	283	10/09→						
JAGUAR - XK II Cabriolet (X150) 03/06→07/14								
 Hauptbremszylinder								
3.6	190	10/07→07/14			B13391→; für Linkslenker		24.4156-1051.3 011069	ATE Ø 27 ohne Bremsflüssigkeitsbehälter
4.2 XK8	219	03/06→07/14						
4.2 XKR	306 -	03/06→07/14			→ B13390; für Linkslenker		24.4156-1051.3 011069	ATE Ø 27 ohne Bremsflüssigkeitsbehälter
	313							
5.0 V8	283	01/09→07/14						
5.0 XKR	375	01/09→07/14						
4.2	291	09/07→12/09			für Linkslenker		24.4156-1051.3 011069	ATE Ø 27 ohne Bremsflüssigkeitsbehälter
5.0 XKR-S	405	01/11→07/14			B13391→; für Linkslenker		24.4156-1051.3 011069	ATE Ø 27 ohne Bremsflüssigkeitsbehälter
JAGUAR - XK II Coupe (X150) 03/06→12/14								
 Hauptbremszylinder								
3.6	190	07/07→07/14			B13391→; für Linkslenker		24.4156-1051.3 011069	ATE Ø 27 ohne Bremsflüssigkeitsbehälter
4.2 XK8	219	03/06→07/14						
4.2 XKR	291 -	03/06→07/14			→ B13390; für Linkslenker		24.4156-1051.3 011069	ATE Ø 27 ohne Bremsflüssigkeitsbehälter
	313							
5.0 V8	283	01/09→07/14						
5.0 XKR	375 -	01/09→07/14						
	390							
5.0 XKR-S	405	01/11→07/14			B13391→; für Linkslenker		24.4156-1051.3 011069	ATE Ø 27 ohne Bremsflüssigkeitsbehälter
JAGUAR - XK 8 Convertible (X100) 03/96→12/06								
Pedalwegsensor, Bremspedal								
4.2	219	08/02→12/06			→ 07/05		03.0655-0007.2 370007	ATE
R 4.2	291	08/02→12/06						
JAGUAR - XK 8 Coupe (X100) 03/96→12/06								
Pedalwegsensor, Bremspedal								
4.2	219	08/02→07/05					03.0655-0007.2 370007	ATE
R 4.2	291	08/02→07/05						
JEEP - COMPASS (MP, M6, MV, M7) 01/16→								
 Hauptbremszylinder								
1.6 Multijet	96	04/21→					24.4123-1731.3 011094	Ø 23,8 ohne Bremsflüssigkeitsbehälter
JEEP - RENEGADE SUV (BU, B1, BV) 07/14→								
 Hauptbremszylinder								
1.0 T-GDi	88	08/18→			für Rechtslenker		24.4123-1731.3 011094	Ø 23,8 ohne Bremsflüssigkeitsbehälter
1.3 T-GDi	110	08/18→						
1.3 T-GDi 4x4	132	08/18→						
1.4	100 -	07/14→						
	103							
1.4 4x4	125	07/14→						
1.4 LPG	88	01/16→						
1.6	81	07/14→09/18						
1.6 CRD	70 -	07/14→						
	88							
→								



















	kw					! #		
JEEP - RENEGADE SUV (BU, B1, BV) 07/14→								
 Hauptbremszylinder								
1.6 MultiJet 2.0 CRD 4x4	96 88 - 125	02/20→ 07/14→		für Rechtslenker		24.4123-1731.3	011094	Ø 23,8 ohne Bremsflüssigkeitsbehälter
JEEP - RENEGADE VAN (BU, B1) 07/14→								
 Hauptbremszylinder								
1.4 1.4 4x4 1.6 E-torQ 1.6 MultiJet 2.0 MultiJet 4x4	103 125 81 88 103 - 125	07/14→ 07/14→ 07/14→09/18 07/14→ 07/14→		für Rechtslenker		24.4123-1731.3	011094	Ø 23,8 ohne Bremsflüssigkeitsbehälter
KIA - CEE'D (JD) 05/12→07/18								
 Hauptbremszylinder								
1.0 T-GDI 1.4 MPI 1.6 CRDi 136	74 - 88 74 100	07/15→07/18 04/15→07/18 07/15→07/18		für Linkslenker		24.4122-1732.3	011107	Ø 22,2 ohne Bremsflüssigkeitsbehälter
1.4 CRDi 90 1.4 CVVT	66 - 73	05/12→07/18 05/12→07/18		für Linkslenker; für Fahrzeuge mit Start-Stopp-Funktion; - ESP		24.4122-1724.3	011080	ATE Ø 22,2 ohne Bremsflüssigkeitsbehälter
1.4 LPG 1.6 CRDi 110 1.6 CRDi 128 1.6 GDI	72 81 94 99	05/12→07/18 05/12→07/18 05/12→07/18 05/12→07/18		für Rechtslenker; - ESP		24.4122-1724.3	011080	ATE Ø 22,2 ohne Bremsflüssigkeitsbehälter
1.6 CVVT	95	01/13→07/18		für Linkslenker; + ESP		24.4122-1732.3	011107	Ø 22,2 ohne Bremsflüssigkeitsbehälter
1.6 CVVT	96	11/14→07/18		für Linkslenker; + ESP		24.4122-1732.3	011107	Ø 22,2 ohne Bremsflüssigkeitsbehälter
1.6 GT	150	06/13→07/18		07/13→; für Linkslenker; für Fahrzeuge ohne Start-Stopp-Funktion		24.4122-1724.3	011080	ATE Ø 22,2 ohne Bremsflüssigkeitsbehälter
				07/13→; für Rechtslenker; - ESP		24.4122-1724.3	011080	ATE Ø 22,2 ohne Bremsflüssigkeitsbehälter
				07/13→; für Linkslenker; für Fahrzeuge mit Start-Stopp-Funktion		24.4122-1732.3	011107	Ø 22,2 ohne Bremsflüssigkeitsbehälter
KIA - CEE'D Combi Van (JD) 07/12→07/18								
 Hauptbremszylinder								
1.0 T-GDI 1.4 CRDi 1.4 CVVT 1.6 GDi	74 - 88 66 73 99	04/15→07/18 04/15→07/18 04/15→07/18 04/15→07/18		für Linkslenker; - ESP		24.4122-1724.3	011080	ATE Ø 22,2 ohne Bremsflüssigkeitsbehälter
1.6 CRDi	94	07/12→07/18		für Linkslenker; + ESP		24.4122-1732.3	011107	Ø 22,2 ohne Bremsflüssigkeitsbehälter
				für Linkslenker; - ESP		24.4122-1724.3	011080	ATE Ø 22,2 ohne Bremsflüssigkeitsbehälter
				für Rechtslenker; - ESP		24.4122-1724.3	011080	ATE Ø 22,2 ohne Bremsflüssigkeitsbehälter
				für Linkslenker; + ESP		24.4122-1732.3	011107	Ø 22,2 ohne Bremsflüssigkeitsbehälter
KIA - CEE'D Sportwagon (JD) 09/12→07/18								
 Hauptbremszylinder								
1.0 T-GDI 1.4 MPI 1.6 CRDi 136	74 - 88 74 100	07/15→07/18 04/15→07/18 07/15→07/18		für Linkslenker		24.4122-1732.3	011107	Ø 22,2 ohne Bremsflüssigkeitsbehälter
1.4 CRDi 90 1.4 CVVT 1.4 LPG 1.6 CRDi 110 1.6 CRDi 128 1.6 GDI	66 - 99	09/12→07/18 09/12→07/15 01/13→07/18 03/13→07/18 09/12→07/15 09/12→07/18		für Linkslenker; für Fahrzeuge mit Start-Stopp-Funktion; - ESP		24.4122-1724.3	011080	ATE Ø 22,2 ohne Bremsflüssigkeitsbehälter
				für Rechtslenker; - ESP		24.4122-1724.3	011080	ATE Ø 22,2 ohne Bremsflüssigkeitsbehälter
1.6 CVVT	95 - 96	11/14→07/18		für Linkslenker; + ESP		24.4122-1732.3	011107	Ø 22,2 ohne Bremsflüssigkeitsbehälter
KIA - PRO CEE'D (JD) 03/13→07/18								
 Hauptbremszylinder								
1.4 CRDi 90 1.4 CVVT 1.6 CRDi 110 1.6 CRDi 128 1.6 GDI	66 - 99	03/13→07/18 07/13→07/18 03/13→07/18 03/13→07/15 03/13→07/18		für Linkslenker; für Fahrzeuge mit Start-Stopp-Funktion; - ESP		24.4122-1724.3	011080	ATE Ø 22,2 ohne Bremsflüssigkeitsbehälter
				für Rechtslenker; - ESP		24.4122-1724.3	011080	ATE Ø 22,2 ohne Bremsflüssigkeitsbehälter

































	kw			 	! #		
KIA - PRO CEE'D (JD) 03/13→07/18							
 Hauptbremszylinder							
1.6 GT	150	06/13→07/18		für Linkslenker; + ESP		24.4122-1732.3 011107	Ø 22,2 ohne Bremsflüssigkeitsbehälter
1.4 CVVT	73	03/13→07/15		für Linkslenker; für Fahrzeuge mit Start-Stopp-Funktion; - ESP		24.4122-1724.3 011080	ATE Ø 22,2 ohne Bremsflüssigkeitsbehälter
				für Rechtslenker; - ESP		24.4122-1724.3 011080	ATE Ø 22,2 ohne Bremsflüssigkeitsbehälter
				für Linkslenker; für Fahrzeuge ohne Start-Stopp-Funktion; + ESP		24.4122-1732.3 011107	Ø 22,2 ohne Bremsflüssigkeitsbehälter
				für Linkslenker; für Fahrzeuge mit Start-Stopp-Funktion; + ESP		24.4122-1732.3 011107	Ø 22,2 ohne Bremsflüssigkeitsbehälter
1.4 MPI 1.6 CRDi 136	74 100	04/15→07/18 07/15→07/18		für Linkslenker		24.4122-1732.3 011107	Ø 22,2 ohne Bremsflüssigkeitsbehälter
KIA - PRO CEE'D Hatchback Van (JD) 03/12→07/18							
 Hauptbremszylinder							
1.4 CRDi 1.6 GDI	66 99	05/15→07/18 04/15→07/18		für Linkslenker; für Fahrzeuge mit Start-Stopp-Funktion; - ESP		24.4122-1724.3 011080	ATE Ø 22,2 ohne Bremsflüssigkeitsbehälter
				für Rechtslenker; - ESP		24.4122-1724.3 011080	ATE Ø 22,2 ohne Bremsflüssigkeitsbehälter
				für Linkslenker; + ESP		24.4122-1732.3 011107	Ø 22,2 ohne Bremsflüssigkeitsbehälter
1.4 CVVT 1.6 CRDi	73 94	05/12→07/18 10/12→07/18		03/13→; für Linkslenker; für Fahrzeuge mit Start-Stopp-Funktion; - ESP		24.4122-1724.3 011080	ATE Ø 22,2 ohne Bremsflüssigkeitsbehälter
				03/13→; für Rechtslenker; - ESP		24.4122-1724.3 011080	ATE Ø 22,2 ohne Bremsflüssigkeitsbehälter
				03/13→; für Linkslenker; + ESP		24.4122-1732.3 011107	Ø 22,2 ohne Bremsflüssigkeitsbehälter
1.4 MPI 1.6 CRDi	74 100	05/15→07/18 05/15→07/18		für Linkslenker		24.4122-1732.3 011107	Ø 22,2 ohne Bremsflüssigkeitsbehälter
KIA - SORENTO I (JC) 08/02→12/11							
 Hauptbremszylinder							
2.5 CRDi 4WD	103	08/02→03/11		→ 11/06; + ABS		24.2126-1702.3 010950	Ø 27
3.5 3.5 V6 4WD	143 143	09/02→12/06 08/02→12/11		→ 11/06; + ABS; Automatikgetriebe		24.2126-1702.3 010950	Ø 27
KIA - SPORTAGE III (SL) 09/09→							
 Hauptbremszylinder							
1.6 GDI 2.0 CRDi 2.0 CRDi AWD 2.0 CVVT 2.0 CVVT AWD 2.0 CVVT Flex 2.0 GDI 2.0 GDI AWD 2.4 i AWD	99 100 100 110 - 122 110 - 122 131 122 - 194 122 130	02/11→ 07/10→ 07/10→ 06/10→ 06/10→ 02/12→12/16 09/13→ 02/14→ 08/10→		+ ESP		24.4122-1723.3 011086	Ø 22,2 ohne Bremsflüssigkeitsbehälter
1.6 LPG	99	01/14→12/15		für Linkslenker; + ESP; - RU		24.4122-1723.3 011086	Ø 22,2 ohne Bremsflüssigkeitsbehälter
2.0 CVVT AWD 2.0 CVVT Flex AWD	110 - 113 131	01/14→12/15 01/12→12/16		für Linkslenker; Fahrzeugproduktionsland Slowakische Republik; + ESP		24.4122-1723.3 011086	Ø 22,2 ohne Bremsflüssigkeitsbehälter
				für Linkslenker; Fahrzeugproduktionsland Republik Korea (Südkorea)		24.4122-1723.3 011086	Ø 22,2 ohne Bremsflüssigkeitsbehälter
KIA - SPORTAGE IV (QL, QLE) 01/15→							
 Hauptbremszylinder							
1.6 CRDi 1.6 CRDi AWD 1.6 CRDi Eco-Dynamics+ 1.6 CRDi Eco-Dynamics+ AWD 1.6 GDI 1.6 T-GDI 1.6 TGDI AWD 1.7 CRDi	85 - 100 100 100 97 130 130 85 - 104	07/18→09/22 07/18→09/22 03/19→09/22 03/19→09/22 09/15→09/22 09/15→09/22 09/15→09/22 09/15→09/22		für Linkslenker		24.4122-1732.3 011107	Ø 22,2 ohne Bremsflüssigkeitsbehälter
→							













	kw			 	! #		
KIA - SPORTAGE IV (QL, QLE) 01/15→							
 Hauptbremszylinder							
1.6 LPG	93	07/20→09/22				24.4122-1732.3 011107	Ø 22,2 ohne Bremsflüssigkeitsbehälter
2.0 AWD	110 - 114	12/15→09/22		für Linkslenker; Fahrzeugproduktionsland Slowakische Republik		24.4122-1732.3 011107	Ø 22,2 ohne Bremsflüssigkeitsbehälter
2.0 CRDi	100 - 136	09/15→09/22					
2.0 CRDi AWD	100 - 136	09/15→09/22					
2.0 CRDi Eco-Dynamics+ AWD	136	06/18→09/22					
KIA - SPORTAGE IV VAN (QL, QLE) 09/15→							
 Hauptbremszylinder							
1.6 CRDi Eco-Dynamics+	100	03/19→		für Linkslenker		24.4122-1732.3 011107	Ø 22,2 ohne Bremsflüssigkeitsbehälter
1.6 CRDi Eco-Dynamics+ All-wheel Drive	100	03/19→					
1.6 T-GDI	130	05/18→					
LADA - 110 (2110) 01/95→12/12							
 Hauptbremszylinder							
1.5	54 - 57	01/95→12/05				24.2120-0803.3 010415	Ø 20,6
1.5 16V	70	01/95→12/05					
1.6	66	01/00→12/08					
2.0 i Wankel	110	08/96→07/00					
	88	06/97→09/04					
1.6	60	01/00→12/12		→ 08/07		24.2120-0803.3 010415	Ø 20,6
LADA - 111 (2111) 01/95→02/09							
 Hauptbremszylinder							
1.5	57	01/96→12/05				24.2120-0803.3 010415	Ø 20,6
1.5 16V	70	01/95→08/02					
1.6	60	09/04→02/09		01/05→ 12/08		24.2120-0803.3 010415	Ø 20,6
1.6	66	09/04→12/07		03/06→		24.2120-0803.3 010415	Ø 20,6
LADA - 112 (2112) 01/95→12/11							
 Hauptbremszylinder							
1.5	57	01/95→09/04				24.2120-0803.3 010415	Ø 20,6
1.5 16V	70	01/95→09/00					
1.6	66	03/06→12/08					
1.6	60	01/05→12/11		→ 12/08		24.2120-0803.3 010415	Ø 20,6
LADA - 1200-1600 01/70→12/05							
 Hauptbremszylinder							
1600 N/L	57	03/79→12/05		→ 06/85		24.2119-0831.3 010416	Ø 19
LADA - NOVA (2105) 05/81→04/12							
 Hauptbremszylinder							
1200 Junior/L	44	09/81→04/12		→ 12/96		24.2119-0832.3 010417	Ø 19
1300 Spezial/L	48	05/81→04/12					
1500 S	52	06/89→04/12					
1500 Special	55	03/85→04/12					
1600	56	01/88→10/01					
1700 i Classic	62	06/96→04/12					
LADA - NOVA Kombi (2104) 09/84→04/12							
 Hauptbremszylinder							
1500	49	08/94→04/12		→ 12/96		24.2119-0832.3 010417	Ø 19
1700	62	08/94→04/12					
LADA - SAMARA (2108, 2109, 2113, 2114) 09/84→12/13							
 Hauptbremszylinder							
1.5	56	04/96→12/13		→ 12/99		24.2120-0803.3 010415	Ø 20,6
1500	52	02/95→12/06					
1.5	59	08/03→12/06				24.2120-0803.3 010415	Ø 20,6
1.6	60	02/09→12/13					
1100	43	02/96→08/99					
1300	45 - 50	09/91→12/99					













	kw					! #		
LADA - SAMARA Schrägheck (2113, 2114) 03/97→12/13								
 Hauptbremszylinder								
1.5	53	08/03→12/13					24.2120-0803.3 010415	Ø 20,6
LADA - SAMARA Stufenheck (21099, 2115) 09/87→12/12								
 Hauptbremszylinder								
1100 1300 1500	39 45 - 46 52	07/91→08/99 05/90→08/99 11/94→12/06		→ 12/95			24.2120-0803.3 010415	Ø 20,6
LADA - TAIGA Geländewagen geschlossen (2121, 2131) 12/76→								
 Hauptbremszylinder								
1700 i 1700 i 4x4 1900 Diesel 1700 i 4x4 1900 Diesel	59 60 55 61 48	06/96→12/06 10/00→12/15 01/99→12/06 05/04→ 01/93→08/99					24.2119-0832.3 010417 24.2120-0803.3 010415 24.2119-0832.3 010417	Ø 19 Ø 20,6 Ø 19
LANCIA - DEDRA (835_) 01/89→07/99								
 Hauptbremszylinder								
1.6 i.e. 1.8 i.e. 1.8 i.e. 2.0 i.e. 1.9 TDS 2.0 i.e. Turbo	55 66 77 83 66 119	04/93→07/99 08/93→07/99 09/89→07/99 09/89→07/99 04/89→07/99 04/91→07/99		→ 10/93; für Linkslenker; - ABS 01/90→ 10/93; für Linkslenker; - ABS 01/90→ 10/93; - ABS 01/90→ 10/93; für Linkslenker; - ABS 05/91→ 10/93; GG			24.2120-1710.3 010468 24.2120-1710.3 010468 24.2120-1710.3 010468 24.2120-1710.3 010468 24.2122-1716.3 010485	Ø 20,6 Ø 20,6 Ø 20,6 Ø 20,6 Ø 22,2
LANCIA - DELTA II (836_) 06/93→09/99								
 Hauptbremszylinder								
1.4 i.e. 1.6 i.e. 1.6 i.e. 16V 1.8 i.e. 1.8 i.e. 16V 1.8 i.e. 16V GT 2.0 16V Turbo 1.6 i.e. 1.8 i.e. 2.0 16V 2.0 16V Turbo	51 66 76 66 83 96 142 55 76 102 137	10/94→08/99 03/96→08/99 01/96→08/99 07/94→08/99 03/96→08/99 03/96→08/99 07/96→08/99 06/93→08/99 06/93→08/99 06/93→08/99		GG → 10/93 11/93→; GG 11/93→; GG			24.2122-1716.3 010485 24.2119-0829.3 010351 24.2122-1716.3 010485 24.2122-1716.3 010485	Ø 22,2 Ø 19 Ø 22,2 Ø 22,2
LANCIA - DELTA III (844_) 08/08→08/14								
 Hauptbremszylinder								
1.4 1.4 16V 1.4 Bifuel 1.6 D Multijet 1.8 1.9 D Multijet 2.0 D Multijet	88 - 110 103 88 77 - 88 147 140 120 - 121	09/08→08/14 07/10→08/14 07/11→08/14 08/08→08/14 01/09→08/14 01/09→08/14 09/08→08/14					24.4123-1710.3 010866	BOS Ø 23,8 ohne Bremsflüssigkeitsbehälter
LANCIA - MUSA (350_) 10/04→09/12								
 Hauptbremszylinder								
1.3 D Multijet 1.4 1.9 D Multijet 1.3 D Multijet 1.4 1.4 LPG 1.6 D Multijet	51 - 66 57 - 70 74 70 66 57 85 - 88	10/04→09/12 10/04→09/12 10/04→09/12 03/09→09/12 10/07→09/12 11/10→09/12 07/08→09/12		→ 11/06; für Fahrzeuge ohne elektronische Fahrdynamikregelung 12/06→			24.2123-1763.3 010842 24.4123-1708.3 010859 24.4123-1708.3 010859	Ø 23,8 BOS Ø 23,8 BOS Ø 23,8
LANCIA - PHEDRA (179_) 09/02→11/10								
 Hauptbremszylinder								
2.0 2.0 D Multijet →	100 100	09/02→11/10 07/06→11/10		→ 09/10			03.2122-2163.3 010800	ATE Ø 22,2

	kw					! #		
LANCIA - PHEDRA (179_) 09/02→11/10								
 Hauptbremszylinder								
2.0 JTD	79 - 88	09/02→11/10		→ 09/10			03.2122-2163.3 010800	ATE Ø 22,2
2.2 D Multijet	125	03/08→11/10						
2.2 JTD	94 - 120	09/02→11/10						
LANCIA - Y (840_) 11/95→09/03								
 Hauptbremszylinder								
1.1	40	11/95→09/03		05/97→ 12/98			24.2120-1710.3 010468	Ø 20,6
1.2	44	03/96→09/03		→ 07/03			24.2120-1710.3 010468	Ø 20,6
1.2 16V	59	10/00→09/03						
1.2 16V	63	04/97→09/03		05/97→ 09/00			24.2120-1710.3 010468	Ø 20,6
1.4 12V	55 - 59	03/96→09/03		→ 12/98			24.2120-1710.3 010468	Ø 20,6
 Bremskraftregler								
1.1	40	11/95→09/03		05/97→ 12/98; - ABS; 			24.6513-1705.3 320237	lastabhängig 2x
1.2	44	03/96→09/03		→ 07/03; - ABS; 			24.6513-1705.3 320237	lastabhängig 2x
1.2 16V	59	10/00→09/03						
1.2 16V	63	04/97→09/03		05/97→ 09/00; - ABS; 			24.6513-1705.3 320237	lastabhängig 2x
1.4 12V	55 - 59	03/96→09/03		→ 12/98; - ABS; 			24.6513-1705.3 320237	lastabhängig 2x
LANCIA - YPSILON (843_) 10/03→12/11								
 Hauptbremszylinder								
1.2	51 - 59	10/03→12/11		→ 06/11; für Fahrzeuge ohne elektronische Fahrdynamikregelung			24.2122-1762.3 010837	Ø 22,2
1.3 JTD	51	10/03→12/11						
1.4	57	02/06→12/11		→ 06/11; für Fahrzeuge mit elektronischer Fahrdynamikregelung			24.2122-1768.3 010853	Ø 22,2
1.4 16V	70	10/03→12/11						
1.4 LPG	57	11/10→12/11						
1.3 D Multijet	55 - 66	09/06→12/11		10/06→ 06/11; für Fahrzeuge ohne elektronische Fahrdynamikregelung			24.2122-1762.3 010837	Ø 22,2
				10/06→ 06/11; für Fahrzeuge mit elektronischer Fahrdynamikregelung			24.2122-1768.3 010853	Ø 22,2
1.3 D Multijet	77	05/07→12/11		07/07→ 06/11; für Fahrzeuge ohne elektronische Fahrdynamikregelung			24.2122-1762.3 010837	Ø 22,2
				07/07→ 06/11; für Fahrzeuge mit elektronischer Fahrdynamikregelung			24.2122-1768.3 010853	Ø 22,2
LANCIA - ZETA (22_) 05/95→10/03								
 Hauptbremszylinder								
2.0 16V	97	05/98→07/00		05/99→			24.2123-1733.3 010657	BOS Ø 23,8
2.0 Turbo	108	05/95→09/02						
2.1 TD	80	05/96→09/99						
2.0 16V	100	07/00→09/02					24.2123-1733.3 010657	BOS Ø 23,8
2.0 JTD	80	09/99→09/02						
2.0 JTD 16V	81	04/01→10/03						
LAND ROVER - DISCOVERY IV (L319) 09/09→12/18								
 Hauptbremszylinder								
2.7 TD 4x4	140	09/09→12/18					24.2026-1704.3 010989	TRW Ø 27 Ø2 20,6
3.0 4x4	250	08/13→12/18						
3.0 SDV6 4x4	188	11/09→12/18						
3.0 TD 4x4	155 - 200	09/09→12/18						
4.0 4x4	160	09/09→12/18						
5.0 V8 4x4	276	09/09→12/18						
LAND ROVER - DISCOVERY IV VAN (L319) 09/09→12/17								
 Hauptbremszylinder								
3.0 TD 4x4	155 - 188	01/11→12/17					24.2026-1704.3 010989	TRW Ø 27 Ø2 20,6
LAND ROVER - FREELANDER 2 (L359) 10/06→12/15								
 Bremskraftverstärker								
2.0 Si4 4x4	177	10/11→10/14					03.7755-1232.4 300260	ATE Ø 9 / 8" pneumatisch
2.2 eD4	110	08/10→10/14						
2.2 SD4 4x4	140	08/10→10/14						
2.2 TD4 4x4	110 - 118	10/06→10/14						
3.2 4x4	171	10/06→10/14						
→								

	kw					! #		
LAND ROVER - FREELANDER 2 (L359) 10/06→12/15								
 Hauptbremszylinder								
2.0 Si4 4x4 2.2 eD4 2.2 SD4 4x4 2.2 TD4 4x4 3.2 4x4	177 110 140 110 - 118 171	10/11→10/14 08/10→10/14 08/10→10/14 10/06→10/14 10/06→10/14					24.4156-1270.3 011058	ATE Ø 27 ohne Bremsflüssigkeitsbehälter
LAND ROVER - FREELANDER 2 VAN (L359) 10/06→10/14								
 Bremskraftverstärker								
2.2 TD4 4x4	118	10/06→10/14					03.7755-1232.4 300260	ATE Ø 9 / 8" pneumatisch
 Hauptbremszylinder								
2.2 TD4 4x4	118	10/06→10/14					24.4156-1270.3 011058	ATE Ø 27 ohne Bremsflüssigkeitsbehälter
LAND ROVER - RANGE ROVER III (L322) 03/02→12/12								
 Hauptbremszylinder								
3.0 D 4x4 3.6 D 4x4 4.2 4x4 4.4 4x4	130 200 291 210 - 225	03/02→08/12 04/06→08/12 05/05→08/12 03/02→08/12	→ 5A999999				24.2026-1705.3 010992	TRW Ø 27 Ø2 20,6
LAND ROVER - RANGE ROVER EVOQUE (L538) 06/11→12/19								
 Hauptbremszylinder								
2.0 4x4	176	09/11→12/19					24.4156-1270.3 011058	ATE Ø 27 ohne Bremsflüssigkeitsbehälter
2.0 D 2.0 D 4x4 2.2 D 2.2 D 4x4	110 110 - 132 110 110 - 140	06/15→12/19 05/15→12/19 06/11→12/19 06/11→12/19	→ FH999999				24.4156-1270.3 011058	ATE Ø 27 ohne Bremsflüssigkeitsbehälter
LAND ROVER - RANGE ROVER EVOQUE Cabriolet (L538) 11/15→12/19								
 Hauptbremszylinder								
2.0 4x4 2.0 D 4x4	177 110 - 132	11/15→12/19 11/15→12/19	→ FH999999				24.4156-1270.3 011058	ATE Ø 27 ohne Bremsflüssigkeitsbehälter
LAND ROVER - RANGE ROVER EVOQUE VAN (L538) 06/11→12/19								
 Hauptbremszylinder								
SD4 4x4 TD4 TD4 4x4 Si4 4x4	140 110 110 177	05/15→12/19 05/15→12/19 05/15→12/19 09/13→12/19	→ FH999999				24.4156-1270.3 011058	ATE Ø 27 ohne Bremsflüssigkeitsbehälter
LAND ROVER - RANGE ROVER SPORT I (L320) 02/05→03/13								
 Hauptbremszylinder								
3.0 D 4x4 5.0 4x4 3.6 D 4x4	155 - 188 276 - 375 200	09/09→03/13 04/09→03/13 04/06→03/13	für Linksenker AA000001→; für Linksenker				24.2026-1704.3 010989	TRW Ø 27 Ø2 20,6
MAZDA - 2 (DY) 02/03→06/07								
 Hauptbremszylinder								
1.2 1.3 L 1.4 1.4 CD 1.6	55 67 59 50 74	04/03→06/07 04/03→06/07 04/03→06/07 04/03→06/07 02/03→06/07	- ABS + ABS				03.4153-0015.3 011005 03.4153-5287.4 010953	ATE Ø 23,8 ohne Bremsflüssigkeitsbehälter ATE Ø 23,8 mit Bremsflüssigkeitsbehälter
MAZDA - 3 (BK) 10/03→12/09								
 Hauptbremszylinder								
1.3 1.6 1.6 DI Turbo 1.6 MZ-CD →	62 77 80 66	10/03→06/09 10/03→06/09 06/04→06/09 06/06→12/09	→ 03/06; für Linksenker → 05/09; für Linksenker				03.2125-0483.3 010783 03.2125-0483.3 010783	ATE Ø 25,4 ohne Bremsflüssigkeitsbehälter ATE Ø 25,4 ohne Bremsflüssigkeitsbehälter

	kw			 	! #		
MAZDA - 3 (BK) 10/03→12/09							
 Hauptbremszylinder							
2.0 2.0 MZR-CD	110 105	10/03→12/09 07/06→06/09		→ 05/09; für Linkslenker		03.2125-0483.3 010783	ATE Ø 25,4 ohne Bremsflüssigkeitsbehälter
2.0 2.3 MZR	104 115	10/03→06/06 10/03→03/09		für Linkslenker		03.2125-0483.3 010783	ATE Ø 25,4 ohne Bremsflüssigkeitsbehälter
MAZDA - 3 (BL) 12/08→09/14							
 Hauptbremszylinder							
1.6 MZ-CD 2.0 DISI 2.0 MZR DISI 2.2 MZR CD	80 110 111 110 - 136	12/08→05/13 05/09→02/12 12/08→05/13 01/09→10/13		06/09→; für Linkslenker		03.2125-0483.3 010783	ATE Ø 25,4 ohne Bremsflüssigkeitsbehälter
1.6 MZR 2.0 MZR	79 108	01/10→12/13 04/09→09/14		für Linkslenker; → 11/13		03.2125-0483.3 010783	ATE Ø 25,4 ohne Bremsflüssigkeitsbehälter
1.6 MZR 2.0 MZR 2.5	77 110 122	12/08→09/14 01/09→09/14 03/09→09/14		06/09→; für Linkslenker; → 11/13		03.2125-0483.3 010783	ATE Ø 25,4 ohne Bremsflüssigkeitsbehälter
1.6 MZR CD	85	09/10→05/13		11/10→; für Linkslenker		03.2125-0483.3 010783	ATE Ø 25,4 ohne Bremsflüssigkeitsbehälter
2.0	113	09/11→10/13		für Linkslenker		03.2125-0483.3 010783	ATE Ø 25,4 ohne Bremsflüssigkeitsbehälter
MAZDA - 3 Stufenheck (BK) 09/99→12/09							
 Hauptbremszylinder							
1.6 1.6 DI Turbo 2.0 MZR-CD	77 80 105	02/04→06/09 06/04→06/09 12/06→06/09		→ 05/09; für Linkslenker		03.2125-0483.3 010783	ATE Ø 25,4 ohne Bremsflüssigkeitsbehälter
2.0 2.3	104 - 110 118	10/03→12/09 03/04→03/09		für Linkslenker		03.2125-0483.3 010783	ATE Ø 25,4 ohne Bremsflüssigkeitsbehälter
MAZDA - 3 Stufenheck (BL) 12/08→12/14							
 Hauptbremszylinder							
1.6 MZR 2.0 MZR 2.2 MZR CD	77 110 110	12/08→09/14 03/09→09/14 01/09→09/14		06/09→; für Linkslenker; → 11/13		03.2125-0483.3 010783	ATE Ø 25,4 ohne Bremsflüssigkeitsbehälter
1.6 MZR CD 2.0 MZR DISI	80 111	12/08→05/13 02/09→05/13		06/09→; für Linkslenker		03.2125-0483.3 010783	ATE Ø 25,4 ohne Bremsflüssigkeitsbehälter
1.6 MZR CD	85	09/10→05/13		11/10→; für Linkslenker		03.2125-0483.3 010783	ATE Ø 25,4 ohne Bremsflüssigkeitsbehälter
2.0 2.2 MZR CD	113 136	09/11→09/14 06/09→05/13		für Linkslenker		03.2125-0483.3 010783	ATE Ø 25,4 ohne Bremsflüssigkeitsbehälter
MAZDA - 6 Hatchback (GG) 08/02→12/08							
 Hauptbremszylinder							
1.8 2.0	88 104 - 108	08/02→08/07 08/02→08/07		→ 07/07; + ESP; Schaltgetriebe		24.2120-1756.3 010975	Ø 20,6 ohne Bremsflüssigkeitsbehälter
2.0 DI 2.3	89 - 105 122	08/02→08/07 08/02→08/07					
3.0	162 - 164	01/04→12/07		+ ESP; Schaltgetriebe		24.2120-1756.3 010975	Ø 20,6 ohne Bremsflüssigkeitsbehälter
MAZDA - 6 Station Wagon (GY) 01/02→02/08							
 Hauptbremszylinder							
1.8 2.0	88 104 - 108	08/02→08/07 08/02→08/07		→ 07/07; + ESP; Schaltgetriebe		24.2120-1756.3 010975	Ø 20,6 ohne Bremsflüssigkeitsbehälter
2.0 DI 2.3 2.3 AWD	89 - 105 122 119	08/02→08/07 01/02→02/08 11/02→08/07					
2.0 DI	100	08/02→02/05		+ ESP; Schaltgetriebe		24.2120-1756.3 010975	Ø 20,6 ohne Bremsflüssigkeitsbehälter
MAZDA - 6 Stufenheck (GG) 06/02→12/08							
 Hauptbremszylinder							
1.8 2.0 →	88 104 - 108	08/02→08/07 06/02→08/07		→ 07/07; + ESP; Schaltgetriebe		24.2120-1756.3 010975	Ø 20,6 ohne Bremsflüssigkeitsbehälter

	kw					! #		
MAZDA - 6 Stufenheck (GG) 06/02→12/08								
 Hauptbremszylinder								
2.0 DI	89 - 105	06/02→08/07			→ 07/07; + ESP; Schaltgetriebe		24.2120-1756.3 010975	Ø 20,6 ohne Bremsflüssigkeitsbehälter
2.3	122	06/02→08/07						
2.3 MPS Turbo	191	12/05→08/07						
2.3	119 - 120	07/03→07/07			+ ESP; Schaltgetriebe		24.2120-1756.3 010975	Ø 20,6 ohne Bremsflüssigkeitsbehälter
MAZDA - BT-50 Pick-up (CD, UN) 08/06→12/15								
 Hauptbremszylinder								
2.5 MRZ-CD	105	08/06→06/13			für Linkslenker; + ABS		24.2125-1747.3 011029	Ø 25,4
2.5 MRZ-CD 4x4	105	12/06→12/15			+ ABS; Schaltgetriebe; → 07/12		24.2125-1747.3 011029	Ø 25,4
3.0 CDVi	115	12/06→12/15			+ ABS; Automatikgetriebe; → 07/12		24.2125-1747.3 011029	Ø 25,4
3.0 CDVi 4x4	115	10/06→12/15			12/06→; + ABS; Schaltgetriebe; → 07/12		24.2125-1747.3 011029	Ø 25,4
					12/06→; + ABS; Automatikgetriebe; → 07/12		24.2125-1747.3 011029	Ø 25,4
MAZDA - BT-50 Pritsche/Fahrgestell (CD, UN) 08/06→								
 Hauptbremszylinder								
2.5 CDVi	105	12/06→			+ ABS; Schaltgetriebe; → 07/12		24.2125-1747.3 011029	Ø 25,4
3.0 CDVi 4x4	115	12/06→			+ ABS; Automatikgetriebe; → 07/12		24.2125-1747.3 011029	Ø 25,4
MAZDA - CX-5 (KE, GH) 11/11→02/17								
 Hauptbremszylinder								
2.0	110 - 121	11/11→02/17			für Linkslenker; Automatikgetriebe		24.2120-1761.3 011090	Ø 20,6 ohne Bremsflüssigkeitsbehälter
2.0 AWD	110 - 118	11/11→02/17						
2.2 D	110 - 129	04/12→02/17						
2.2 D 4WD	129	04/12→02/17						
2.2 D AWD	110 - 129	04/12→02/17						
2.5	137 - 138	02/13→02/17						
2.5 AWD	141	02/15→02/17						
2.0 AWD	113	02/12→02/17			für Linkslenker		24.2120-1761.3 011090	Ø 20,6 ohne Bremsflüssigkeitsbehälter
MAZDA - CX-5 (KF) 11/16→								
 Hauptbremszylinder								
2.0	110 - 121	05/17→			für Linkslenker; Automatikgetriebe		24.2120-1761.3 011090	Ø 20,6 ohne Bremsflüssigkeitsbehälter
2.0 AWD	121	06/18→						
2.0 SKYACTIV-G	120	03/18→						
2.0 SKYACTIV-G AWD	120	03/18→						
2.2 D	110	05/17→02/18						
2.2 D AWD	110	05/17→02/18						
2.0 AWD	110	03/18→			für Linkslenker		24.2120-1761.3 011090	Ø 20,6 ohne Bremsflüssigkeitsbehälter
2.5	141 - 143	05/17→						
2.0 AWD	118	05/17→			Automatikgetriebe		24.2120-1761.3 011090	Ø 20,6 ohne Bremsflüssigkeitsbehälter
2.2 D	129	05/17→						
2.2 D AWD	129	05/17→02/18						
2.0 e-SKYACTIV G 165	121	02/23→			für Linkslenker; Getriebeautomatik 6 Gang		24.2120-1761.3 011090	Ø 20,6 ohne Bremsflüssigkeitsbehälter
2.0 e-SKYACTIV G 165 AWD	121	02/23→						
2.5 e-SKYACTIV G 194	143	02/23→						
2.5 e-SKYACTIV G 194 AWD	143	02/23→						
2.5 AWD	143	05/17→					24.2120-1761.3 011090	Ø 20,6 ohne Bremsflüssigkeitsbehälter
MAZDA - CX-5 Van (KE_) 11/11→02/17								
 Hauptbremszylinder								
SKYACTIV-D	110	04/15→02/17			für Linkslenker; Automatikgetriebe		24.2120-1761.3 011090	Ø 20,6 ohne Bremsflüssigkeitsbehälter
SKYACTIV-D AWD	110 - 129	04/15→02/17						
SKYACTIV-G	121	04/15→02/17						
SKYACTIV-G AWD	118 - 141	04/15→02/17						

	kw			 	! #		
MERCEDES-BENZ - A-KLASSE (W168) 07/97→08/05							
 Hauptbremszylinder							
A 140	60	07/97→08/04		09/97→		24.4122-1701.3 010533	TRW Ø 22,2
A 160	75	07/97→08/04					
A 140	60	01/01→08/04				24.4122-1701.3 010533	TRW Ø 22,2
A 160 CDI	55	02/01→08/04					
A 170 CDI	70	02/01→08/04					
A 210	103	12/01→08/04					
A 160 CDI	44	07/98→02/01		08/98→ 01/01		24.4122-1701.3 010533	TRW Ø 22,2
A 170 CDI	66	07/98→02/01		→ 01/01		24.4122-1701.3 010533	TRW Ø 22,2
A 190	92	03/99→08/04		05/99→		24.4122-1701.3 010533	TRW Ø 22,2
MERCEDES-BENZ - A-KLASSE (W169) 04/04→06/12							
 Hauptbremszylinder							
A 150	70	09/04→06/12		→ 05/12		24.2123-1776.3 010926	TRW Ø 23,8
A 160	70	04/09→06/12					
A 160 CDI	60	09/04→06/12					
A 170	85	09/04→06/12					
A 180	85	04/09→06/12					
A 180 CDI	80	09/04→06/12					
A 200	100	09/04→06/12					
A 200 CDI	100 -	09/04→06/12					
	103						
A 200 TURBO	142	09/05→06/12					
E-CELL	50	12/10→06/12					
MERCEDES-BENZ - A-KLASSE (W176) 06/12→05/18							
 Hauptbremszylinder							
A 160	75	07/15→05/18		für Linkslenker		24.4123-1718.3 011016	TRW Ø 23,8 ohne Bremsflüssigkeitsbehälter
A 160 CDI / d	66	06/13→05/18					
A 180	90	09/12→05/18					
A 180 CDI / d	80	06/12→05/18					
A 180 CDI	80	06/12→10/14					
A 200	115	06/12→05/18					
A 200 CDI / d	100	02/14→05/18					
A 200 CDI / d 4-matic	100	02/14→05/18					
A 220 4-matic	135	05/14→05/18					
A 220 CDI	120 -	09/12→05/18					
	125						
A 220 CDI 4-matic	125	02/14→05/18					
A 220 d	130	07/15→05/18					
A 220 d 4-matic	130	07/15→05/18					
A 250	155 -	06/12→05/18					
	160						
A 250 4-matic	155 -	06/13→05/18					
	160						
A 45 AMG 4-matic	265	06/13→05/18					
AMG A 45 4-matic	280	07/15→05/18					
A 200 CDI	100	06/12→10/14		für Linkslenker; → 02/14		24.4123-1718.3 011016	TRW Ø 23,8 ohne Bremsflüssigkeitsbehälter
MERCEDES-BENZ - B-KLASSE Sports Tourer (W245) 03/05→11/11							
 Hauptbremszylinder							
B 150	70	03/05→11/11		→ 04/11		24.2123-1776.3 010926	TRW Ø 23,8
B 160	70	04/09→11/11					
B 170	85	03/05→11/11					
B 180	85	04/09→11/11					
B 180 CDI	80	03/05→11/11					
B 200	100	03/05→11/11					
B 200 CDI	100 -	03/05→11/11					
	103						
B 200 TURBO	142	03/05→11/11					
B 170 NGT	85	04/08→11/11		→ 04/09		24.2123-1776.3 010926	TRW Ø 23,8
B 180 NGT	85	04/08→11/11		04/09→ 04/11		24.2123-1776.3 010926	TRW Ø 23,8
MERCEDES-BENZ - B-KLASSE Sports Tourer (W246, W242) 10/11→12/18							
 Hauptbremszylinder							
B 160	75	07/15→12/18		für Linkslenker		24.4123-1718.3 011016	TRW Ø 23,8 ohne Bremsflüssigkeitsbehälter
B 160 CDI / d	66	05/13→12/18					
B 180	90	11/11→12/18					
B 180 CDI / d	80	02/13→12/18					
B 180 CDI	80	11/11→08/14					
B 200	115	11/11→12/18					
B 200 CDI / d	100	08/14→12/18					
B 200 CDI / d 4-matic	100	08/14→12/18					
B 200 CDI	100	11/11→08/14					
B 200 Natural Gas Drive / B 200 c	115	11/12→12/17					
→							



MERCEDES-BENZ - B-KLASSE Sports Tourer (W246, W242) 10/11→12/18

Hauptbremszylinder

B 220 4-matic B 220 CDI / d	135 120 - 130	05/13→12/18 06/13→12/18		für Linkslenker		24.4123-1718.3	011016	TRW Ø 23,8 ohne Bremsflüssigkeitsbehälter
B 220 CDI / d 4-matic B 220 d 4-matic B 250 4-matic	130 125 155	08/14→12/18 06/18→12/18 08/14→12/18						
B 220 CDI / d	125	11/11→12/18		12/12→; für Linkslenker		24.4123-1718.3	011016	TRW Ø 23,8 ohne Bremsflüssigkeitsbehälter
B 250	155	05/12→12/18		09/12→; für Linkslenker		24.4123-1718.3	011016	TRW Ø 23,8 ohne Bremsflüssigkeitsbehälter











MERCEDES-BENZ - C-KLASSE (W202) 03/93→05/00











Bremskraftverstärker









C 180	89 - 90	03/93→05/00		A021677 / F011180→ A519673 / F619720		03.7760-2702.4	300090	ATE Ø 10" pneumatisch
C 200 C 200 Kompressor	100 132 - 141	01/94→05/00 10/95→05/00		→ A519673 / F619720		03.7760-2702.4	300090	ATE Ø 10" pneumatisch
C 230 Kompressor C 250 Turbo-D	142 110	10/95→05/00 10/95→05/00						
C 200 D C 220 D	55 - 65 55 - 70	03/93→05/00 08/93→05/00		A072908 / F060570→ A519673 / F619720		03.7760-2702.4	300090	ATE Ø 10" pneumatisch
C 220	110	03/93→05/00		→ 08/96		03.7760-2702.4	300090	ATE Ø 10" pneumatisch
C 250 D	83	05/93→05/00		→ 08/95; A072908 / F060570→		03.7760-2702.4	300090	ATE Ø 10" pneumatisch
C 280	142	05/93→05/00		06/93→ 05/97		03.7760-2702.4	300090	ATE Ø 10" pneumatisch
C 36 AMG	206	05/94→05/00		→ 08/97		03.7760-2702.4	300090	ATE Ø 10" pneumatisch

Hauptbremszylinder













C 180	89	11/94→05/00		F011180→		03.2023-0825.3	010028	Ø1 23,8 Ø2 19
				A021677→ A136773		03.2023-0825.3	010028	Ø1 23,8 Ø2 19
				→ A021676 / F011179		24.2022-1601.3	010340	Ø1 22,2 Ø2 17,5
				A136774→		24.2023-1701.3	010514	TRW Ø1 23,8 Ø2 19
C 180	90	03/93→05/00		F011180→		03.2023-0825.3	010028	Ø1 23,8 Ø2 19
				A021677→ A136773		03.2023-0825.3	010028	Ø1 23,8 Ø2 19
				→ A021676 / F011179		24.2022-1601.3	010340	Ø1 22,2 Ø2 17,5
				A136774→ A519673		24.2023-1701.3	010514	TRW Ø1 23,8 Ø2 19
				A519674→		24.2023-1702.3	010534	TRW Ø1 23,8 Ø2 19
C 200	100	01/94→05/00		→ A136773 / F110261		03.2023-0825.3	010028	Ø1 23,8 Ø2 19
				A136774 / F110262→		24.2023-1701.3	010514	TRW Ø1 23,8 Ø2 19
C 200 CDI C 220 CDI	75 92	03/98→05/00 09/97→05/00				24.2023-1702.3	010534	TRW Ø1 23,8 Ø2 19
C 200 D	55 - 65	03/93→05/00		A072908 / F060570→		03.2023-0825.3	010028	Ø1 23,8 Ø2 19
				→ A072907 / F060569		24.2022-1601.3	010340	Ø1 22,2 Ø2 17,5
C 200 Kompressor	132 - 141	10/95→05/00		→ A519673 / F619720		24.2023-1701.3	010514	TRW Ø1 23,8 Ø2 19
C 230 Kompressor C 250 Turbo-D	142 110	10/95→05/00 10/95→05/00		A519674 / F619721→		24.2023-1702.3	010534	TRW Ø1 23,8 Ø2 19
C 220	110	03/93→05/00		06/93→; → A136773 / F110261		03.2023-0825.3	010028	Ø1 23,8 Ø2 19
				→ 08/96; A136774 / F110262→		24.2023-1701.3	010514	TRW Ø1 23,8 Ø2 19
C 220 D	55 - 70	08/93→05/00		A072908 / F060570→ A136773 / F110261		03.2023-0825.3	010028	Ø1 23,8 Ø2 19
				→ A072907 / F060569		24.2022-1601.3	010340	Ø1 22,2 Ø2 17,5
				A136774 / F110262→ A519673 / F619720		24.2023-1701.3	010514	TRW Ø1 23,8 Ø2 19
				A519674 / F619721→		24.2023-1702.3	010534	TRW Ø1 23,8 Ø2 19
C 240	125	06/97→05/00		- ESP		24.2023-1702.3	010534	TRW Ø1 23,8 Ø2 19
				+ ESP		24.2023-1704.3	010635	TRW Ø 23,8
C 250 D	83	05/93→05/00		A072908 / F060570→; → 08/95		03.2023-0825.3	010028	Ø1 23,8 Ø2 19
				06/93→; → A072907 / F060569		24.2022-1601.3	010340	Ø1 22,2 Ø2 17,5
C 280	142	05/93→05/00		06/93→; → A136773 / F110261		03.2023-0825.3	010028	Ø1 23,8 Ø2 19
				→ 05/97; A136774 / F110262→		24.2023-1701.3	010514	TRW Ø1 23,8 Ø2 19
				06/97→; - ESP		24.2023-1702.3	010534	TRW Ø1 23,8 Ø2 19
				06/97→; + ESP		24.2023-1704.3	010635	TRW Ø 23,8
C 280	145	06/97→05/00		→ A136773 / F110261		03.2023-0825.3	010028	Ø1 23,8 Ø2 19
				- ESP		24.2023-1702.3	010534	TRW Ø1 23,8 Ø2 19
→								











	kW			 	! #		
MERCEDES-BENZ - C-KLASSE (W202) 03/93→05/00							
 Hauptbremszylinder							
C 280	145	06/97→05/00		+ ESP		24.2023-1704.3 010635	TRW Ø 23,8
C 36 AMG	206	05/94→05/00		→ A136773 / F110261		03.2023-0825.3 010028	Ø1 23,8 Ø2 19
				→ 08/97; A136774 / F110262→		24.2023-1701.3 010514	TRW Ø1 23,8 Ø2 19
C 43 AMG	225	08/97→05/00		für Linkslenker; → F737081		24.2025-1703.3 010516	Ø1 25,4 Ø2 19
				für Rechtslenker		24.2025-1709.3 010693	Ø 25,4
				für Linkslenker; F737082→		24.2025-1709.3 010693	Ø 25,4
MERCEDES-BENZ - C-KLASSE (W203) 05/00→12/07							
 Bremskraftverstärker							
C 180	95	10/00→05/02		für Linkslenker		03.7848-2002.4 300166	ATE Ø 7 / 8" pneumatisch
C 180 Kompressor	105	05/02→02/07					
C 200 CDI	75 - 90	09/00→02/07					
C 200 CGI Kompressor	125	07/03→02/07					
C 200 Kompressor	120	05/02→02/07					
C 220 CDI	100 - 105	05/00→02/07					
C 230 Kompressor	141	02/04→02/07					
C 240	125	05/00→02/07					
C 240 4-matic	125	07/02→02/07					
C 270 CDI	120 - 125	12/00→02/07					
C 30 CDI AMG	170	01/03→02/07					
C 320	160	05/00→02/07					
C 320 4-matic	160	07/02→02/07					
C 55 AMG	270	02/04→02/07					
C 200 Kompressor	120	05/00→06/02		→ 05/02; für Linkslenker		03.7848-2002.4 300166	ATE Ø 7 / 8" pneumatisch
C 220 CDI	110	04/03→02/07		02/04→; für Linkslenker		03.7848-2002.4 300166	ATE Ø 7 / 8" pneumatisch
C 230	150	01/05→02/07		06/05→; für Linkslenker		03.7848-2002.4 300166	ATE Ø 7 / 8" pneumatisch
C 280	170	01/05→02/07					
C 280 4-matic	170	01/05→02/07					
C 350	200	01/05→02/07					
C 350 4-matic	200	01/05→02/07					
C 320 CDI	165	01/05→02/07		02/05→; für Linkslenker		03.7848-2002.4 300166	ATE Ø 7 / 8" pneumatisch
C 32 AMG Kompressor	260	02/01→02/07		03/01→; für Linkslenker		03.7848-2002.4 300166	ATE Ø 7 / 8" pneumatisch
Pedalwegsensoren, Bremspedal							
C 180	95	10/00→05/02				03.0655-0007.2 370007	ATE
C 180 Kompressor	105	05/02→02/07					
C 200 CDI	75 - 90	09/00→02/07					
C 200 CGI Kompressor	125	07/03→02/07					
C 200 Kompressor	120	05/02→02/07					
C 220 CDI	100 - 105	05/00→02/07					
C 230 Kompressor	141	02/04→02/07					
C 240	125	05/00→02/07					
C 240 4-matic	125	07/02→02/07					
C 270 CDI	120 - 125	12/00→02/07					
C 30 CDI AMG	170	01/03→02/07					
C 320	160	05/00→02/07					
C 320 4-matic	160	07/02→02/07					
C 55 AMG	270	02/04→02/07					
C 200 Kompressor	120	05/00→06/02		→ 05/02		03.0655-0007.2 370007	ATE
C 220 CDI	110	04/03→02/07		02/04→		03.0655-0007.2 370007	ATE
C 230	150	01/05→02/07		06/05→		03.0655-0007.2 370007	ATE
C 280	170	01/05→02/07					
C 350	200	01/05→02/07					
C 350 4-matic	200	01/05→02/07					
C 280 4-matic	170	01/05→02/07		06/05→; für Linkslenker		03.0655-0007.2 370007	ATE
C 320 CDI	165	01/05→02/07		02/05→		03.0655-0007.2 370007	ATE
C 32 AMG Kompressor	260	02/01→02/07		03/01→		03.0655-0007.2 370007	ATE
 Hauptbremszylinder							
C 180	95	10/00→05/02		für Linkslenker		03.2023-1741.3 010703	ATE Ø1 23,8 Ø2 20,6
C 180 Kompressor	105	05/02→02/07					
C 200 CDI	75 - 90	09/00→02/07					
C 200 CGI Kompressor	125	07/03→02/07					
C 200 Kompressor	120	05/02→02/07					
C 220 CDI	100 - 105	05/00→02/07					
C 230 Kompressor	141	02/04→02/07					
C 240	125	05/00→02/07					
→							











	kw					! #		
MERCEDES-BENZ - C-KLASSE (W203) 05/00→12/07								
 Hauptbremszylinder								
C 200 Kompressor	120	05/00→06/02			→ 05/02; für Linkslenker		03.2023-1741.3 010703	ATE Ø1 23,8 Ø2 20,6
C 220 CDI	110	04/03→02/07			02/04→; für Linkslenker		03.2023-1741.3 010703	ATE Ø1 23,8 Ø2 20,6
C 230	150	01/05→02/07			06/05→; für Linkslenker		03.2025-1741.3 010705	ATE Ø1 25,4 Ø2 20,6
C 280	170	01/05→02/07						
C 280 4-matic	170	01/05→02/07						
C 350	200	01/05→02/07						
C 350 4-matic	200	01/05→02/07						
C 240 4-matic	125	07/02→02/07			für Linkslenker		03.2025-1741.3 010705	ATE Ø1 25,4 Ø2 20,6
C 270 CDI	120 - 125	12/00→02/07						
C 30 CDI AMG	170	01/03→02/07						
C 320	160	05/00→02/07						
C 320 4-matic	160	07/02→02/07						
C 55 AMG	270	02/04→02/07						
C 320 CDI	165	01/05→02/07			02/05→; für Linkslenker		03.2025-1741.3 010705	ATE Ø1 25,4 Ø2 20,6
C 32 AMG Kompressor	260	02/01→02/07			03/01→; für Linkslenker		03.2025-1741.3 010705	ATE Ø1 25,4 Ø2 20,6
MERCEDES-BENZ - C-KLASSE (W204) 01/07→01/15								
 Bremskraftverstärker								
C 180 CDI	88	04/10→03/14			für Linkslenker; für Fahrzeuge ohne Start-Stopp-Funktion		03.7745-6302.4 300261	ATE Ø 8" pneumatisch
C 180 Kompressor	115	01/08→01/14						
C 200	137	05/11→01/14						
C 200 CDI	100	11/09→03/14			für Linkslenker; für Fahrzeuge mit Start-Stopp-Funktion		03.7745-8902.4 300297	ATE Ø 8" pneumatisch
C 220 CDI	120 - 125	10/08→01/14						
C 220 CDI 4-matic	125	02/13→01/14						
C 230 4-matic	150	07/07→01/14						
C 250 CDI	150	08/08→01/14						
C 250 CDI 4-matic	150	01/11→01/14						
C 250 CGI	150	07/09→01/14						
C 280 4-matic	170	07/07→01/14						
C 300	185	02/11→01/14						
C 300 4-matic	185	02/11→01/14						
C 300 CDI 4-matic	170	01/11→01/14						
C 320 CDI 4-matic	165	07/07→01/14						
C 350	225	01/11→01/14						
C 350 4-matic	200 - 225	07/07→01/14						
C 350 CDI	170 - 195	10/09→01/14						
C 350 CDI 4-matic	165 - 170	07/09→01/14						
C 350 CGI	215	09/08→01/14						
C 180 CGI	115	01/07→01/14			04/09→; für Linkslenker; für Fahrzeuge ohne Start-Stopp-Funktion		03.7745-6302.4 300261	ATE Ø 8" pneumatisch
C 200 CGI	135	01/07→01/14						
C 300 4-matic	170	07/07→01/14			04/09→; für Linkslenker; für Fahrzeuge mit Start-Stopp-Funktion		03.7745-8902.4 300297	ATE Ø 8" pneumatisch
C 180 Kompressor	115	01/07→01/14			03/07→; für Linkslenker; für Fahrzeuge ohne Start-Stopp-Funktion		03.7745-6302.4 300261	ATE Ø 8" pneumatisch
C 200 CDI	100	01/07→12/09						
C 220 CDI	120	01/07→11/08			03/07→; für Linkslenker; für Fahrzeuge mit Start-Stopp-Funktion		03.7745-8902.4 300297	ATE Ø 8" pneumatisch
C 230	150	01/07→01/14						
C 200 Kompressor	135	01/07→01/14			A 017628 / F 015295→; für Linkslenker; für Fahrzeuge ohne Start-Stopp-Funktion		03.7745-6302.4 300261	ATE Ø 8" pneumatisch
C 220 CDI	125	01/07→11/08						
C 280	170	01/07→01/14						
C 300	170	07/09→01/14			A 017628 / F 015295→; für Linkslenker; für Fahrzeuge mit Start-Stopp-Funktion		03.7745-8902.4 300297	ATE Ø 8" pneumatisch
C 320 CDI	165	01/07→01/14						
C 350	200	01/07→01/14						
C 350 CDI	165	07/09→01/14						
C 63 AMG	336 - 373	02/08→01/14						
C 63 AMG DR 520	383	07/10→01/14						
 Hauptbremszylinder								
C 180 CDI	88	04/10→03/14			für Linkslenker		03.2025-2521.3 010959	ATE Ø1 25,4 Ø2 22,2
C 180 Kompressor	115	01/08→01/14						
C 200	137	05/11→01/14			für Rechtslenker		24.2025-2311.3 011023	ATE Ø1 25,4 Ø2 20,6
C 200 CDI	100	11/09→03/14						
C 220 CDI	120 - 125	10/08→01/14						
C 220 CDI 4-matic	125	02/13→01/14						
C 230 4-matic	150	07/07→01/14						
C 250 CDI 4-matic	150	01/11→01/14						
C 250 CGI	150	07/09→01/14						
C 280 4-matic	170	07/07→01/14						
C 300	170 - 185	07/09→01/14						
C 300 4-matic	185	02/11→01/14						
C 300 CDI 4-matic	170	01/11→01/14						
C 320 CDI 4-matic	165	07/07→01/14						
→								











	kW					! #		
MERCEDES-BENZ - C-KLASSE (W204) 01/07→01/15								
 Hauptbremszylinder								
C 350	225	01/11→01/14		für Linkslenker		03.2025-2521.3	010959	ATE Ø1 25,4 Ø2 22,2
C 350 4-matic	200 - 225	07/07→01/14		für Rechtslenker		24.2025-2311.3	011023	ATE Ø1 25,4 Ø2 20,6
C 350 CDI	165 - 195	07/09→01/14						
C 350 CDI 4-matic	165 - 170	07/09→01/14						
C 350 CGI	215	09/08→01/14						
C 63 AMG	336 - 373	02/08→01/14						
C 63 AMG DR 520	383	07/10→01/14						
C 180 CGI	115	01/07→01/14		04/09→; für Linkslenker		03.2025-2521.3	010959	ATE Ø1 25,4 Ø2 22,2
C 200 CGI	135	01/07→01/14		04/09→; für Rechtslenker		24.2025-2311.3	011023	ATE Ø1 25,4 Ø2 20,6
C 300 4-matic	170	07/07→01/14						
C 180 Kompressor	115	01/07→01/14		03/07→; für Linkslenker		03.2025-2521.3	010959	ATE Ø1 25,4 Ø2 22,2
C 200 CDI	100	01/07→12/09		03/07→; für Rechtslenker		24.2025-2311.3	011023	ATE Ø1 25,4 Ø2 20,6
C 200 Kompressor	135	01/07→01/14						
C 220 CDI	120 - 125	01/07→11/08						
C 230	150	01/07→01/14						
C 280	170	01/07→01/14						
C 320 CDI	165	01/07→01/14						
C 350	200	01/07→01/14						
C 250 CDI	150	08/08→01/14		10/08→; für Linkslenker		03.2025-2521.3	010959	ATE Ø1 25,4 Ø2 22,2
				10/08→; für Rechtslenker		24.2025-2311.3	011023	ATE Ø1 25,4 Ø2 20,6
MERCEDES-BENZ - C-KLASSE (W205) 07/13→02/23								
 Hauptbremszylinder								
AMG C 43 4-matic	270	04/16→05/18		für Linkslenker		24.4156-1136.3	011126	ATE Ø 27 ohne Bremsflüssigkeitsbehälter
AMG C 63	350	10/14→05/21						
AMG C 63 S	375	10/14→05/21						
C 160	95	04/15→11/19						
C 180	110 - 115	03/14→03/21						
C 180 BlueTEC / d	85	05/14→05/18						
C 200 4-matic	135	04/15→08/18						
C 200 BlueTEC / d	100	05/14→05/18						
C 200 d	100	10/15→05/18						
C 220 BlueTEC / d	120 - 125	02/14→05/18						
C 220 d 4-matic	125	04/15→05/18						
C 250	155	03/14→05/18						
C 250 BlueTEC / d	150	02/14→05/18						
C 250 BlueTEC / d 4-matic	150	02/14→05/18						
C 300	180	09/15→08/18						
C 300 BlueTEC Hybrid / h	170	05/14→05/18						
C 350 e	205	02/15→08/18						
C 400 4-matic	245	10/14→11/20						
C 450 AMG 4-matic	270	04/15→05/18						
AMG C 43 4-matic	287	05/18→05/21		für Linkslenker; +SA 805/806 / 807/808		24.4156-1136.3	011126	ATE Ø 27 ohne Bremsflüssigkeitsbehälter
				für Linkslenker; SA Code ab: 809 →		24.4156-1221.3	011127	ATE Ø 27 ohne Bremsflüssigkeitsbehälter
C 160	95	06/19→05/21		für Linkslenker		24.4156-1221.3	011127	ATE Ø 27 ohne Bremsflüssigkeitsbehälter
C 180	115	06/19→05/21						
C 180 d	90	05/18→05/21						
C 200	150	08/19→05/21						
C 200 d	110 - 118	05/18→05/21						
C 200 EQ Boost	135	04/18→06/21						
C 200 EQ Boost 4-matic	135	04/18→05/21						
C 220 d	143	05/18→05/21						
C 220 d 4-matic	143	05/18→05/21						
C 300	183 - 190	05/18→05/21						
C 300 4-matic	190	05/18→05/21						
C 300 d	180	06/18→05/21						
C 300 d 4-matic	180	06/18→05/21						
C 300 de	225	05/19→05/21						
C 300 e	235	07/19→05/21						
C 300 e 4-matic	235	07/19→05/21						
C 300 EQ Boost	190	05/19→05/21						
C 300 EQ Boost 4-matic	190	05/19→05/21						
C 200	135	12/13→08/18		02/14→; für Linkslenker		24.4156-1136.3	011126	ATE Ø 27 ohne Bremsflüssigkeitsbehälter
C 200 4-matic	150	08/19→05/21		für Linkslenker; +SA 805/806 / 807/808		24.4156-1136.3	011126	ATE Ø 27 ohne Bremsflüssigkeitsbehälter
C 300 4-matic	180	12/13→08/18						
→								























	kw					! #		
MERCEDES-BENZ - C-KLASSE (W205) 07/13→02/23								
 Hauptbremszylinder								
C 200 4-matic C 300 4-matic	150 180	08/19→05/21 12/13→08/18		für Linkslenker		24.4156-1221.3	011127	ATE Ø 27 ohne Bremsflüssigkeitsbehälter
MERCEDES-BENZ - C-KLASSE Cabriolet (A205) 06/16→04/23								
 Hauptbremszylinder								
AMG C 43 4-matic	270 - 287	10/16→04/23		für Linkslenker; +SA 805/806 / 807/808		24.4156-1136.3	011126	ATE Ø 27 ohne Bremsflüssigkeitsbehälter
AMG C 63 AMG C 63 S	350 375	10/16→04/23 10/16→04/23		für Linkslenker; SA Code ab: 809 →		24.4156-1221.3	011127	ATE Ø 27 ohne Bremsflüssigkeitsbehälter
C 180 C 200 C 200 4-matic C 220 d	115 135 135 120 - 125	06/16→08/20 06/16→05/18 06/16→05/18 06/16→05/18		für Linkslenker		24.4156-1136.3	011126	ATE Ø 27 ohne Bremsflüssigkeitsbehälter
C 220 d 4-matic C 250 C 250 d C 300 C 400 4-matic	125 155 150 180 245	06/16→05/18 06/16→05/18 06/16→05/18 06/16→05/18 06/16→04/23						
C 180 C 200 C 200 d C 200 EQ Boost C 200 EQ Boost 4-matic C 220 d C 220 d 4-matic C 300 C 300 d C 300 EQ Boost C 300 EQ Boost 4-matic	115 150 118 135 135 143 143 190 180 190 190	06/19→04/23 08/19→04/23 07/18→11/19 05/18→04/23 05/18→04/23 04/18→04/23 06/18→04/23 05/18→04/23 07/18→04/23 05/19→04/23 05/19→04/23		für Linkslenker		24.4156-1221.3	011127	ATE Ø 27 ohne Bremsflüssigkeitsbehälter
MERCEDES-BENZ - C-KLASSE Coupe (C204) 01/11→								
 Bremskraftverstärker								
C 180 C 200 CGI C 220 CDI	115 135 120 - 125	06/11→ 06/11→ 06/11→		für Linkslenker; für Fahrzeuge ohne Start-Stopp-Funktion		03.7745-6302.4	300261	ATE Ø 8" pneumatisch
C 250 C 250 CDI C 350 C 350 4-matic C 63 AMG	150 150 225 225 336 - 380	06/11→ 06/11→ 06/11→ 09/13→ 06/11→		für Linkslenker; für Fahrzeuge mit Start-Stopp-Funktion		03.7745-8902.4	300297	ATE Ø 8" pneumatisch
 Hauptbremszylinder								
C 180 C 200 CGI C 220 CDI	115 135 120 - 125	06/11→ 06/11→ 06/11→		für Linkslenker		03.2025-2521.3	010959	ATE Ø1 25,4 Ø2 22,2
C 250 C 250 CDI C 350 C 350 4-matic C 63 AMG	150 150 225 225 336 - 380	06/11→ 06/11→ 06/11→ 09/13→ 06/11→		für Rechtslenker		24.2025-2311.3	011023	ATE Ø1 25,4 Ø2 20,6
MERCEDES-BENZ - C-KLASSE Coupe (C205) 10/15→04/23								
 Hauptbremszylinder								
AMG C 43 4-matic AMG C 63 AMG C 63 S C 180	270 350 375 110 - 115	04/16→05/18 02/16→04/23 02/16→04/23 10/15→08/20				24.4156-1136.3	011126	ATE Ø 27 ohne Bremsflüssigkeitsbehälter
C 200 C 200 4-matic C 220 d	135 135 120 - 125	10/15→05/18 04/16→05/18 10/15→05/18						
C 220 d 4-matic C 250 C 250 d C 250 d 4-matic C 300 C 400 4-matic	125 155 150 150 180 245	04/16→05/18 10/15→05/18 10/15→05/18 04/16→05/18 10/15→12/18 04/16→06/22						
AMG C 43 4-matic	287	05/18→04/23		für Linkslenker; +SA 805/806 / 807/808		24.4156-1136.3	011126	ATE Ø 27 ohne Bremsflüssigkeitsbehälter
				für Linkslenker; SA Code ab: 809 →		24.4156-1221.3	011127	ATE Ø 27 ohne Bremsflüssigkeitsbehälter
→								











	kw					! #		
MERCEDES-BENZ - C-KLASSE Coupe (C205) 10/15→04/23								
 Hauptbremszylinder								
C 180	115	06/19→04/23		für Linkslenker		24.4156-1221.3	011127	ATE Ø 27 ohne Bremsflüssigkeitsbehälter
C 200 d	118	07/18→11/19						
C 200 EQ Boost	135	05/18→04/23						
C 200 EQ Boost 4-matic	135	05/18→04/23						
C 220 d	143	04/18→04/23						
C 220 d 4-matic	143	06/18→04/23						
C 300	190	05/18→04/23						
C 300 4-matic	190	05/18→04/23						
C 300 d	180	07/18→04/23						
C 300 d 4-matic	180	07/18→04/23						
C 300 EQ Boost	190	05/19→04/23						
C 300 EQ Boost 4-matic	190	05/19→04/23						
MERCEDES-BENZ - C-KLASSE Sportcoupe (CL203) 03/01→06/11								
 Bremskraftverstärker								
C 160 Kompressor	90	05/02→05/08		04/05→; für Linkslenker		03.7848-2002.4	300166	ATE Ø 7 / 8" pneumatisch
C 180	95	03/01→05/02		für Linkslenker		03.7848-2002.4	300166	ATE Ø 7 / 8" pneumatisch
C 180 Kompressor	105	05/02→05/08						
C 200 Kompressor	120	03/01→05/08						
C 220	120	05/02→05/08						
C 220 CDI	100 - 110	03/01→05/08						
C 230 Kompressor	141 - 145	03/01→05/08						
C 30 CDI AMG	170	09/02→05/08						
C 320	160	09/02→05/08						
C 200 CDI	90	03/03→05/08		07/03→; für Linkslenker		03.7848-2002.4	300166	ATE Ø 7 / 8" pneumatisch
C 200 CGI Kompressor	125	03/03→05/08						
C 230	150	01/05→05/08		06/05→; für Linkslenker		03.7848-2002.4	300166	ATE Ø 7 / 8" pneumatisch
C 350	200	01/05→05/08						
Pedalwegsensor, Bremspedal								
C 160 Kompressor	90	05/02→05/08		04/05→		03.0655-0007.2	370007	ATE
C 180	95	03/01→05/02				03.0655-0007.2	370007	ATE
C 180 Kompressor	105	05/02→05/08						
C 200 Kompressor	120	03/01→05/08						
C 220	120	05/02→05/08						
C 220 CDI	100 - 110	03/01→05/08						
C 230 Kompressor	141 - 145	03/01→05/08						
C 30 CDI AMG	170	09/02→05/08						
C 320	160	09/02→05/08						
C 200 CDI	90	03/03→05/08		07/03→		03.0655-0007.2	370007	ATE
C 200 CGI Kompressor	125	03/03→05/08						
C 230	150	01/05→05/08		06/05→		03.0655-0007.2	370007	ATE
C 350	200	01/05→05/08						
 Hauptbremszylinder								
C 160 Kompressor	90	05/02→05/08		04/05→; für Linkslenker		03.2023-1741.3	010703	ATE Ø1 23,8 Ø2 20,6
C 180	95	03/01→05/02		für Linkslenker		03.2023-1741.3	010703	ATE Ø1 23,8 Ø2 20,6
C 180 Kompressor	105	05/02→05/08						
C 200 Kompressor	120	03/01→05/08						
C 220	120	05/02→05/08						
C 220 CDI	100 - 110	03/01→05/08						
C 230 Kompressor	141 - 145	03/01→05/08						
C 200 CDI	90	03/03→05/08		07/03→; für Linkslenker		03.2023-1741.3	010703	ATE Ø1 23,8 Ø2 20,6
C 200 CGI Kompressor	125	03/03→05/08						
C 230	150	01/05→05/08		06/05→; für Linkslenker		03.2025-1741.3	010705	ATE Ø1 25,4 Ø2 20,6
C 350	200	01/05→05/08						
C 30 CDI AMG	170	09/02→05/08		für Linkslenker		03.2025-1741.3	010705	ATE Ø1 25,4 Ø2 20,6
C 320	160	09/02→05/08						
MERCEDES-BENZ - C-KLASSE T-Model (S202) 06/96→03/01								
 Bremskraftverstärker								
C 180 T	90 - 95	06/96→03/01		→ F619720		03.7760-2702.4	300090	ATE Ø 10" pneumatisch
C 200 T	100	06/96→03/01						
C 200 T D	65	10/96→03/01						
C 200 T Kompressor	120 - 141	11/96→03/01						
C 220 T D	55	06/96→03/01						
C 250 T Turbo-D	110	06/96→03/01						
→								











	kw					! #		
MERCEDES-BENZ - C-KLASSE T-Model (S202) 06/96→03/01								
 Hauptbremszylinder								
C 180 T	90 - 95	06/96→03/01		→ F619720		24.2023-1701.3	010514	TRW Ø1 23,8 Ø2 19
C 200 T	100	06/96→03/01		F619721→		24.2023-1702.3	010534	TRW Ø1 23,8 Ø2 19
C 200 T D	65	10/96→03/01						
C 200 T Kompressor	141	11/96→03/01						
C 220 T D	55	06/96→03/01						
C 250 T Turbo-D	110	06/96→03/01						
C 200 T CDI	75	03/98→03/01				24.2023-1702.3	010534	TRW Ø1 23,8 Ø2 19
C 220 T CDI	92	09/97→03/01						
C 230 T Kompressor	142	06/97→09/00						
C 200 T Kompressor	120	09/00→03/01		→ F619720		24.2023-1701.3	010514	TRW Ø1 23,8 Ø2 19
				F619621→		24.2023-1702.3	010534	TRW Ø1 23,8 Ø2 19
C 240 T	125	06/97→03/01		- ESP		24.2023-1702.3	010534	TRW Ø1 23,8 Ø2 19
C 280 T	145	06/97→03/01		+ ESP		24.2023-1704.3	010635	TRW Ø 23,8
C 43 AMG	225	08/97→03/01		für Linkslenker; → F737081		24.2025-1703.3	010516	Ø1 25,4 Ø2 19
				für Rechtslenker		24.2025-1709.3	010693	Ø 25,4
				für Linkslenker; F737082→		24.2025-1709.3	010693	Ø 25,4
MERCEDES-BENZ - C-KLASSE T-Model (S203) 03/01→08/07								
 Bremskraftverstärker								
C 180	95	03/01→05/02		für Linkslenker		03.7848-2002.4	300166	ATE Ø 7 / 8" pneumatisch
C 180 Kompressor	105	05/02→08/07						
C 200 CDI	75 - 90	03/01→08/07						
C 200 CGI Kompressor	125	07/03→08/07						
C 200 Kompressor	120	05/02→08/07						
C 220 CDI	100 - 110	03/01→08/07						
C 230 Kompressor	141	02/04→08/07						
C 240	125	03/01→08/07						
C 240 4-matic	125	07/02→08/07						
C 270 CDI	120 - 125	03/01→08/07						
C 30 CDI AMG	170	01/03→08/07						
C 320	160	03/01→08/07						
C 320 4-matic	160	07/02→08/07						
C 320 CDI	165	06/05→08/07						
C 32 AMG Kompressor	260	03/01→08/07						
C 55 AMG	270	02/04→08/07						
C 200 Kompressor	120	03/01→05/02		→ 04/02; für Linkslenker		03.7848-2002.4	300166	ATE Ø 7 / 8" pneumatisch
C 230	150	01/05→08/07		06/05→; für Linkslenker		03.7848-2002.4	300166	ATE Ø 7 / 8" pneumatisch
C 280	170	01/05→08/07						
C 280 4-matic	170	01/05→08/07						
C 350	200	01/05→08/07						
C 350 4-matic	200	01/05→08/07						
Pedalwegsensor, Bremspedal								
C 180	95	03/01→05/02				03.0655-0007.2	370007	ATE
C 180 Kompressor	105	05/02→08/07						
C 200 CDI	75 - 90	03/01→08/07						
C 200 CGI Kompressor	125	07/03→08/07						
C 200 Kompressor	120	05/02→08/07						
C 220 CDI	100 - 110	03/01→08/07						
C 230 Kompressor	141	02/04→08/07						
C 240	125	03/01→08/07						
C 240 4-matic	125	07/02→08/07						
C 270 CDI	120 - 125	03/01→08/07						
C 30 CDI AMG	170	01/03→08/07						
C 320	160	03/01→08/07						
C 320 4-matic	160	07/02→08/07						
C 320 CDI	165	06/05→08/07						
C 32 AMG Kompressor	260	03/01→08/07						
C 55 AMG	270	02/04→08/07						
C 200 Kompressor	120	03/01→05/02		→ 04/02		03.0655-0007.2	370007	ATE
C 230	150	01/05→08/07		06/05→		03.0655-0007.2	370007	ATE
C 280	170	01/05→08/07						
C 350	200	01/05→08/07						
C 350 4-matic	200	01/05→08/07						
C 280 4-matic	170	01/05→08/07		06/05→; für Linkslenker		03.0655-0007.2	370007	ATE
 Hauptbremszylinder								
C 180	95	03/01→05/02		für Linkslenker		03.2023-1741.3	010703	ATE Ø1 23,8 Ø2 20,6
C 180 Kompressor	105	05/02→08/07						
→								

	kW					! #		
MERCEDES-BENZ - C-KLASSE T-Model (S203) 03/01→08/07								
 Hauptbremszylinder								
C 200 CDI	75 - 90	03/01→08/07		für Linkslenker		03.2023-1741.3	010703	ATE Ø1 23,8 Ø2 20,6
C 200 CGI Kompressor	125	07/03→08/07						
C 200 Kompressor	120	05/02→08/07						
C 220 CDI	100 - 110	03/01→08/07						
C 230 Kompressor	141	02/04→08/07						
C 240	125	03/01→08/07						
C 200 Kompressor	120	03/01→05/02		→ 04/02; für Linkslenker		03.2023-1741.3	010703	ATE Ø1 23,8 Ø2 20,6
C 230	150	01/05→08/07		06/05→; für Linkslenker		03.2025-1741.3	010705	ATE Ø1 25,4 Ø2 20,6
C 280	170	01/05→08/07						
C 280 4-matic	170	01/05→08/07						
C 350	200	01/05→08/07						
C 350 4-matic	200	01/05→08/07						
C 240 4-matic	125	07/02→08/07		für Linkslenker		03.2025-1741.3	010705	ATE Ø1 25,4 Ø2 20,6
C 270 CDI	120 - 125	03/01→08/07						
C 30 CDI AMG	170	01/03→08/07						
C 320	160	03/01→08/07						
C 320 4-matic	160	07/02→08/07						
C 320 CDI	165	06/05→08/07						
C 32 AMG Kompressor	260	03/01→08/07						
C 55 AMG	270	02/04→08/07						
MERCEDES-BENZ - C-KLASSE T-Model (S204) 08/07→08/14								
 Bremskraftverstärker								
C 180	115	02/12→08/14		für Linkslenker; für Fahrzeuge ohne Start-Stopp-Funktion		03.7745-6302.4	300261	ATE Ø 8" pneumatisch
C 180 CDI	88	04/10→08/14						
C 180 CGI	115	11/09→08/14		für Linkslenker; für Fahrzeuge mit Start-Stopp-Funktion		03.7745-8902.4	300297	ATE Ø 8" pneumatisch
C 180 Kompressor	115	01/08→08/14						
C 200 CDI	100	08/10→08/14						
C 220 CDI	120 - 125	12/08→08/14						
C 220 CDI 4-matic	125	02/13→08/14						
C 250	150	02/08→12/12						
C 250 CDI 4-matic	150	04/10→08/14						
C 250 CGI	150	07/09→08/14						
C 300	170	08/07→08/14						
C 300 CDI 4-matic	170	06/11→08/14						
C 350 CDI	165 - 195	08/07→08/14						
C 350 CDI 4-matic	170	10/09→08/14						
C 350 CGI	225	06/11→08/14						
C 63 AMG	336 - 383	02/08→08/14						
C 180 Kompressor	115	08/07→08/14		09/07→; für Linkslenker; für Fahrzeuge ohne Start-Stopp-Funktion		03.7745-6302.4	300261	ATE Ø 8" pneumatisch
C 200 CDI	100	08/07→12/09						
C 200 Kompressor	135	08/07→08/14		09/07→; für Linkslenker; für Fahrzeuge mit Start-Stopp-Funktion		03.7745-8902.4	300297	ATE Ø 8" pneumatisch
C 220 CDI	125	08/07→11/08						
C 230	150	08/07→08/14						
C 280	170	08/07→08/14						
C 320 CDI	165	08/07→08/14						
C 320 CDI 4-matic	165	08/07→12/11						
C 350	200	08/07→08/14						
C 350 CDI 4-matic	165	08/07→12/11						
C 200 CGI	135	08/07→08/14		04/09→; für Linkslenker; für Fahrzeuge ohne Start-Stopp-Funktion		03.7745-6302.4	300261	ATE Ø 8" pneumatisch
C 250 CDI	150	01/09→08/14		04/09→; für Linkslenker; für Fahrzeuge mit Start-Stopp-Funktion		03.7745-8902.4	300297	ATE Ø 8" pneumatisch
C 220 CDI	120	08/07→11/08		09/07→; für Linkslenker; für Fahrzeuge ohne Start-Stopp-Funktion		03.7745-6302.4	300261	ATE Ø 8" pneumatisch
				für Linkslenker; für Fahrzeuge ohne Start-Stopp-Funktion		03.7745-6302.4	300261	ATE Ø 8" pneumatisch
				09/07→; für Linkslenker; für Fahrzeuge mit Start-Stopp-Funktion		03.7745-8902.4	300297	ATE Ø 8" pneumatisch
				für Linkslenker; für Fahrzeuge mit Start-Stopp-Funktion		03.7745-8902.4	300297	ATE Ø 8" pneumatisch
 Hauptbremszylinder								
C 180	115	02/12→08/14		für Linkslenker		03.2025-2521.3	010959	ATE Ø1 25,4 Ø2 22,2
C 180 CDI	88	04/10→08/14						
C 180 CGI	115	11/09→08/14		für Rechtslenker		24.2025-2311.3	011023	ATE Ø1 25,4 Ø2 20,6
C 180 Kompressor	115	01/08→08/14						
C 200 CDI	100	08/10→08/14						
C 220 CDI	120 - 125	12/08→08/14						
C 220 CDI 4-matic	125	02/13→08/14						
C 250	150	02/08→12/12						
C 250 CDI 4-matic	150	04/10→08/14						
C 250 CGI	150	07/09→08/14						
→								













	kw					! #		
MERCEDES-BENZ - C-KLASSE T-Model (S204) 08/07→08/14								
 Hauptbremszylinder								
C 300	170	08/07→08/14		für Linkslenker		03.2025-2521.3	010959	ATE Ø1 25,4 Ø2 22,2
C 300 CDI 4-matic	170	06/11→08/14		für Rechtslenker		24.2025-2311.3	011023	ATE Ø1 25,4 Ø2 20,6
C 350 CDI	165 - 195	08/07→08/14						
C 350 CDI 4-matic	170	10/09→08/14						
C 350 CGI	225	06/11→08/14						
C 63 AMG	336 - 383	02/08→08/14						
C 180 Kompressor	115	08/07→08/14		09/07→; für Linkslenker		03.2025-2521.3	010959	ATE Ø1 25,4 Ø2 22,2
C 200 CDI	100	08/07→12/09		09/07→; für Rechtslenker		24.2025-2311.3	011023	ATE Ø1 25,4 Ø2 20,6
C 200 Kompressor	135	08/07→08/14						
C 220 CDI	125	08/07→11/08						
C 230	150	08/07→08/14						
C 280	170	08/07→08/14						
C 320 CDI	165	08/07→08/14						
C 320 CDI 4-matic	165	08/07→12/11						
C 350	200	08/07→08/14						
C 350 CDI 4-matic	165	08/07→12/11						
C 200 CGI	135	08/07→08/14		04/09→; für Linkslenker		03.2025-2521.3	010959	ATE Ø1 25,4 Ø2 22,2
C 250 CDI	150	01/09→08/14		04/09→; für Rechtslenker		24.2025-2311.3	011023	ATE Ø1 25,4 Ø2 20,6
C 220 CDI	120	08/07→11/08		09/07→; für Linkslenker		03.2025-2521.3	010959	ATE Ø1 25,4 Ø2 22,2
				für Linkslenker		03.2025-2521.3	010959	ATE Ø1 25,4 Ø2 22,2
				09/07→; für Rechtslenker		24.2025-2311.3	011023	ATE Ø1 25,4 Ø2 20,6
				für Rechtslenker		24.2025-2311.3	011023	ATE Ø1 25,4 Ø2 20,6
MERCEDES-BENZ - C-KLASSE T-Model (S205) 09/14→02/23								
 Hauptbremszylinder								
AMG C 43 4-matic	270 - 287	04/16→02/21		für Linkslenker; +SA 805/806 / 807/808		24.4156-1136.3	011126	ATE Ø 27 ohne Bremsflüssigkeitsbehälter
				für Linkslenker; SA Code ab: 809 →		24.4156-1221.3	011127	ATE Ø 27 ohne Bremsflüssigkeitsbehälter
AMG C 63	350	10/15→02/21		für Linkslenker		24.4156-1136.3	011126	ATE Ø 27 ohne Bremsflüssigkeitsbehälter
AMG C 63 S	375	10/15→02/21						
C 160	95	04/15→11/19						
C 180	115	09/14→08/20						
C 180 BlueTEC / d	85	09/14→05/18						
C 200	135	09/14→05/18						
C 200 4-matic	135	04/15→05/18						
C 200 BlueTEC / d	100	09/14→05/18						
C 200 d	100	10/15→05/18						
C 220 BlueTEC / d	120 - 125	09/14→05/18						
C 220 d 4-matic	125	04/15→05/18						
C 250	155	09/14→05/18						
C 250 BlueTEC / d	150	09/14→05/18						
C 250 BlueTEC / d 4-matic	150	10/14→05/18						
C 300	180	09/15→05/18						
C 300 BlueTEC Hybrid / h	150	10/14→05/18						
C 350 e	205	02/15→05/18						
C 400 4-matic	245	10/14→02/21						
C 450 AMG 4-matic	270	04/15→05/18						
C 160	95	06/19→11/19		für Linkslenker		24.4156-1221.3	011127	ATE Ø 27 ohne Bremsflüssigkeitsbehälter
C 180	115	06/19→02/21						
C 180 d	90	05/18→02/21						
C 200 d	110 - 118	05/18→02/21						
C 200 EQ Boost	135	04/18→02/21						
C 200 EQ Boost 4-matic	135	04/18→02/21						
C 220 d	143	04/18→02/21						
C 220 d 4-matic	143	05/18→02/21						
C 300	190	05/18→02/21						
C 300 4-matic	190	05/18→02/21						
C 300 d	180	06/18→02/21						
C 300 d 4-matic	180	06/18→02/21						
C 300 de	225	05/19→02/21						
C 300 e	235	07/19→02/21						
C 300 EQ Boost	190	05/19→02/21						
C 300 EQ Boost 4-matic	190	05/19→02/21						
MERCEDES-BENZ - CLA Coupe (C117) 01/13→03/19								
 Hauptbremszylinder								
AMG CLA 45 4-matic	280	07/15→03/19		für Linkslenker		24.4123-1718.3	011016	TRW Ø 23,8 ohne Bremsflüssigkeitsbehälter
CLA 180	90	01/13→03/19						
CLA 180 CDI / d	80	10/13→05/18						
CLA 200	110 - 115	01/13→03/19						
→								











	kw			 	! #		
MERCEDES-BENZ - CLA Coupe (C117) 01/13→03/19							
 Hauptbremszylinder							
CLA 200 CDI / d	100	07/14→03/19		für Linkslenker		24.4123-1718.3 011016	TRW Ø 23,8 ohne Bremsflüssigkeitsbehälter
CLA 200 CDI / d 4-matic	100	07/14→03/19					
CLA 200 CDI	100	06/13→08/14					
CLA 220 4-matic	135	04/16→03/19					
CLA 220 CDI / d	120 - 130	01/13→03/19					
CLA 220 CDI / d 4-matic	120 - 130	08/14→03/19					
CLA 220 CDI 4-matic	125	07/14→03/19					
CLA 250	155 - 160	01/13→03/19					
CLA 250 4-matic	155 - 160	07/13→03/19					
CLA 45 AMG 4-matic	265	07/13→03/19					
MERCEDES-BENZ - CLA Shooting Brake (X117) 01/15→03/19							
 Hauptbremszylinder							
AMG CLA 45 4-matic	280	07/15→03/19		für Linkslenker		24.4123-1718.3 011016	TRW Ø 23,8 ohne Bremsflüssigkeitsbehälter
CLA 180	90	01/15→03/19					
CLA 180 d	80	07/15→05/18					
CLA 200	115	01/15→03/19					
CLA 200 CDI / d	100	01/15→03/19					
CLA 200 CDI / d 4-matic	100	01/15→03/19					
CLA 220 4-matic	135	04/16→03/19					
CLA 220 CDI / d	120 - 130	01/15→03/19					
CLA 220 CDI / d 4-matic	120 - 130	01/15→03/19					
CLA 220 d	125	07/18→03/19					
CLA 220 d 4-matic	125	07/18→03/19					
CLA 250	155	01/15→03/19					
CLA 250 4-matic	155 - 160	01/15→03/19					
CLA 45 AMG 4-matic	265	01/15→07/15					
MERCEDES-BENZ - CLC-KLASSE (CL203) 05/08→06/11							
 Bremskraftverstärker							
CLC 160	95	02/09→06/11		→ 10/10; für Linkslenker		03.7848-2002.4 300166	ATE Ø 7 / 8" pneumatisch
CLC 180 Kompressor	105	05/08→06/11					
CLC 200 CDI	90	05/08→06/11					
CLC 200 Kompressor	135	05/08→06/11					
CLC 220 CDI	100 - 110	05/08→06/11					
CLC 350	200	05/08→06/11					
CLC 230	150	05/08→06/11		für Linkslenker		03.7848-2002.4 300166	ATE Ø 7 / 8" pneumatisch
CLC 250	150	06/09→06/11					
Pedalwegsensoren, Bremspedal							
CLC 160	95	02/09→06/11		→ 10/10		03.0655-0007.2 370007	ATE
CLC 180 Kompressor	105	05/08→06/11					
CLC 200 CDI	90	05/08→06/11					
CLC 200 Kompressor	135	05/08→06/11					
CLC 220 CDI	100 - 110	05/08→06/11					
CLC 350	200	05/08→06/11					
CLC 230	150	05/08→06/11				03.0655-0007.2 370007	ATE
CLC 250	150	06/09→06/11					
 Hauptbremszylinder							
CLC 160	95	02/09→06/11		→ 10/10; für Linkslenker		03.2023-1741.3 010703	ATE Ø1 23,8 Ø2 20,6
CLC 180 Kompressor	105	05/08→06/11					
CLC 200 CDI	90	05/08→06/11					
CLC 200 Kompressor	135	05/08→06/11					
CLC 220 CDI	100 - 110	05/08→06/11					
CLC 230	150	05/08→06/11		für Linkslenker		03.2025-1741.3 010705	ATE Ø1 25,4 Ø2 20,6
CLC 250	150	06/09→06/11					
CLC 350	200	05/08→06/11		→ 10/10; für Linkslenker		03.2025-1741.3 010705	ATE Ø1 25,4 Ø2 20,6
MERCEDES-BENZ - CLK (C208) 06/97→12/03							
Pedalwegsensoren, Bremspedal							
CLK 200	100	06/97→06/02		F 129679→		03.0655-0007.2 370007	ATE
CLK 200 Kompressor	141	06/97→06/00					
CLK 230 Kompressor	142	06/97→06/00					
CLK 200 Kompressor	120	06/00→06/02				03.0655-0007.2 370007	ATE
CLK 230 Kompressor	145	06/00→06/02					
→							











	kw					! #		
MERCEDES-BENZ - CLK (C208) 06/97→12/03								
 Hauptbremszylinder								
CLK 200	100	06/97→06/02		F 129679→; für Linkslenker		03.2023-2004.3	010788	ATE Ø1 23,8 Ø2 19
CLK 200 Kompressor	141	06/97→06/00		→ F 129678; - ESP		24.2023-1702.3	010534	TRW Ø1 23,8 Ø2 19
CLK 230 Kompressor	142	06/97→06/00						
CLK 200 Kompressor	120	06/00→06/02		für Linkslenker		03.2023-2004.3	010788	ATE Ø1 23,8 Ø2 19
CLK 230 Kompressor	145	06/00→06/02						
CLK 320	160	06/97→06/02		→ F 129678; - ESP		24.2023-1702.3	010534	TRW Ø1 23,8 Ø2 19
				F 129679→		24.2023-1704.3	010635	TRW Ø 23,8
				→ F 129678; + ESP		24.2023-1704.3	010635	TRW Ø 23,8
CLK 430	205	07/98→06/02				24.2025-1709.3	010693	Ø 25,4
CLK 55 AMG	255	08/99→06/02						
MERCEDES-BENZ - CLK (C209) 05/02→03/10								
 Bremskraftverstärker								
CLK 200 CGI	125	07/03→05/09		→ 04/09; für Linkslenker		03.7848-2002.4	300166	ATE Ø 7 / 8" pneumatisch
CLK 200 Kompressor	120 - 135	09/02→05/09						
CLK 240	120 - 125	06/02→05/09						
CLK 270 CDI	125	10/02→05/09						
CLK 320	160	06/02→05/09						
CLK 500	225 - 285	06/02→05/09						
CLK 55 AMG	270	09/02→05/09						
CLK 63 AMG	354 - 373	04/06→05/09						
CLK 220 CDI	100 - 110	01/05→05/09		05/05→ 04/09; für Linkslenker		03.7848-2002.4	300166	ATE Ø 7 / 8" pneumatisch
CLK 280	170	01/05→05/09						
CLK 320 CDI	165	01/05→05/09						
CLK 350	200	01/05→05/09						
CLK 270 CDI	120	02/03→06/05		für Linkslenker		03.7848-2002.4	300166	ATE Ø 7 / 8" pneumatisch
Pedalwegsensoren, Bremspedal								
CLK 200 CGI	125	07/03→05/09		→ 04/09		03.0655-0007.2	370007	ATE
CLK 200 Kompressor	120 - 135	09/02→05/09						
CLK 240	120 - 125	06/02→05/09						
CLK 270 CDI	125	10/02→05/09						
CLK 320	160	06/02→05/09						
CLK 500	225 - 285	06/02→05/09						
CLK 55 AMG	270	09/02→05/09						
CLK 63 AMG	354 - 373	04/06→05/09						
CLK 220 CDI	100 - 110	01/05→05/09		05/05→ 04/09		03.0655-0007.2	370007	ATE
CLK 280	170	01/05→05/09						
CLK 320 CDI	165	01/05→05/09						
CLK 350	200	01/05→05/09						
CLK 270 CDI	120	02/03→06/05				03.0655-0007.2	370007	ATE
 Hauptbremszylinder								
CLK 200 CGI	125	07/03→05/09		→ 04/09; für Linkslenker; für Fahrzeuge ohne Sportpaket / für Fahrzeuge ohne AMG-Sportpaket		03.2023-1741.3	010703	ATE Ø1 23,8 Ø2 20,6
CLK 200 Kompressor	120	09/02→05/09						
CLK 270 CDI	125	10/02→05/09		→ 04/09; für Linkslenker; für Fahrzeuge mit Sportpaket / für Fahrzeuge mit AMG-Sportpaket		03.2025-1741.3	010705	ATE Ø1 25,4 Ø2 20,6
CLK 200 Kompressor	135	10/06→05/09		→ 04/09; für Linkslenker; für Fahrzeuge ohne AMG-Sportpaket / für Fahrzeuge ohne Sportpaket		03.2023-1741.3	010703	ATE Ø1 23,8 Ø2 20,6
				→ 04/09; für Linkslenker; für Fahrzeuge mit Sportpaket / für Fahrzeuge mit AMG-Sportpaket		03.2025-1741.3	010705	ATE Ø1 25,4 Ø2 20,6
CLK 220 CDI	100 - 110	01/05→05/09		05/05→ 04/09; für Linkslenker		03.2025-1741.3	010705	ATE Ø1 25,4 Ø2 20,6
CLK 280	170	01/05→05/09						
CLK 320 CDI	165	01/05→05/09						
CLK 350	200	01/05→05/09						
CLK 240	120 - 125	06/02→05/09		→ 04/09; für Linkslenker		03.2025-1741.3	010705	ATE Ø1 25,4 Ø2 20,6
CLK 320	160	06/02→05/09						
CLK 500	225 - 285	06/02→05/09						
CLK 55 AMG	270	09/02→05/09						
CLK 63 AMG	354 - 373	04/06→05/09						
→								

	kw					! #		
MERCEDES-BENZ - CLK (C209) 05/02→03/10								
 Hauptbremszylinder								
CLK 270 CDI	120	02/03→06/05		für Linkslenker; für Fahrzeuge ohne Sportpaket / für Fahrzeuge ohne AMG-Sportpaket		03.2023-1741.3	010703	ATE Ø1 23,8 Ø2 20,6
				für Linkslenker; für Fahrzeuge mit Sportpaket / für Fahrzeuge mit AMG-Sportpaket		03.2025-1741.3	010705	ATE Ø1 25,4 Ø2 20,6
MERCEDES-BENZ - CLK Cabriolet (A208) 03/98→03/02								
Pedalwegsensoren, Bremspedal								
CLK 200	100	03/98→03/02		T 028296→		03.0655-0007.2	370007	ATE
CLK 200 Kompressor	141	03/98→06/00						
CLK 230 Kompressor	142	03/98→06/00						
CLK 200 Kompressor	120	06/00→03/02		T 028296→		03.0655-0007.2	370007	ATE
CLK 230 Kompressor	145	06/00→03/02				03.0655-0007.2	370007	ATE
 Hauptbremszylinder								
CLK 200	100	03/98→03/02		T 028296→; für Linkslenker		03.2023-2004.3	010788	ATE Ø1 23,8 Ø2 19
CLK 200 Kompressor	141	03/98→06/00		06/98→; → T 028295; - ESP		24.2023-1702.3	010534	TRW Ø1 23,8 Ø2 19
CLK 230 Kompressor	142	03/98→06/00						
CLK 200 Kompressor	120	06/00→03/02		für Linkslenker		03.2023-2004.3	010788	ATE Ø1 23,8 Ø2 19
CLK 230 Kompressor	145	06/00→03/02		T 028296→; für Linkslenker		03.2023-2004.3	010788	ATE Ø1 23,8 Ø2 19
				→ T 028295; - ESP		24.2023-1702.3	010534	TRW Ø1 23,8 Ø2 19
CLK 320	160	03/98→03/02		06/98→; → T 028295; - ESP		24.2023-1702.3	010534	TRW Ø1 23,8 Ø2 19
				T 028296→		24.2023-1704.3	010635	TRW Ø 23,8
				06/98→; → T 028295; + ESP		24.2023-1704.3	010635	TRW Ø 23,8
CLK 430	205	09/98→03/02		06/99→		24.2025-1709.3	010693	Ø 25,4
CLK 55 AMG	255	01/00→03/02				24.2025-1709.3	010693	Ø 25,4
MERCEDES-BENZ - CLK Cabriolet (A209) 06/02→03/10								
 Bremskraftverstärker								
CLK 200 CGI	125	07/03→03/10		→ 12/09; für Linkslenker		03.7848-2002.4	300166	ATE Ø 7 / 8" pneumatisch
CLK 200 Kompressor	135	10/06→03/10						
CLK 500	285	06/06→03/10						
CLK 63 AMG	354	04/06→03/10						
CLK 200 Kompressor	120	02/03→03/10		05/03→ 12/09; für Linkslenker		03.7848-2002.4	300166	ATE Ø 7 / 8" pneumatisch
CLK 240	125	02/03→03/10						
CLK 320	160	02/03→03/10						
CLK 500	225	02/03→03/10						
CLK 55 AMG	270	06/02→03/10						
CLK 280	170	01/05→03/10		05/05→ 12/09; für Linkslenker		03.7848-2002.4	300166	ATE Ø 7 / 8" pneumatisch
CLK 320 CDI	165	03/05→03/10						
CLK 350	200	01/05→03/10						
CLK 63 AMG	354	09/06→12/09		für Linkslenker		03.7848-2002.4	300166	ATE Ø 7 / 8" pneumatisch
Pedalwegsensoren, Bremspedal								
CLK 200 CGI	125	07/03→03/10		→ 12/09		03.0655-0007.2	370007	ATE
CLK 200 Kompressor	135	10/06→03/10						
CLK 500	285	06/06→03/10						
CLK 63 AMG	354	04/06→03/10						
CLK 200 Kompressor	120	02/03→03/10		05/03→ 12/09		03.0655-0007.2	370007	ATE
CLK 240	125	02/03→03/10						
CLK 320	160	02/03→03/10						
CLK 500	225	02/03→03/10						
CLK 55 AMG	270	06/02→03/10						
CLK 280	170	01/05→03/10		05/05→ 12/09		03.0655-0007.2	370007	ATE
CLK 320 CDI	165	03/05→03/10						
CLK 350	200	01/05→03/10						
CLK 63 AMG	354	09/06→12/09				03.0655-0007.2	370007	ATE
 Hauptbremszylinder								
CLK 200 CGI	125	07/03→03/10		→ 12/09; für Linkslenker		03.2023-1741.3	010703	ATE Ø1 23,8 Ø2 20,6
CLK 200 Kompressor	135	10/06→03/10		→ 12/09; für Linkslenker		03.2025-1741.3	010705	ATE Ø1 25,4 Ø2 20,6
CLK 500	285	06/06→03/10						
CLK 63 AMG	354	04/06→03/10						
CLK 200 Kompressor	120	02/03→03/10		05/03→ 12/09; für Linkslenker		03.2025-1741.3	010705	ATE Ø1 25,4 Ø2 20,6
CLK 240	125	02/03→03/10						
CLK 320	160	02/03→03/10						
CLK 500	225	02/03→03/10						
CLK 55 AMG	270	06/02→03/10						
CLK 280	170	01/05→03/10		05/05→ 12/09; für Linkslenker		03.2025-1741.3	010705	ATE Ø1 25,4 Ø2 20,6
CLK 320 CDI	165	03/05→03/10						
CLK 350	200	01/05→03/10						
CLK 63 AMG	354	09/06→12/09		für Linkslenker		03.2025-1741.3	010705	ATE Ø1 25,4 Ø2 20,6



	kw			 	! #		
MERCEDES-BENZ - CLS (C218) 01/11→12/17							
 Bremskraftverstärker							
CLS 250 CDI / BlueTEC / d	150	04/11→12/17		für Linkslenker		03.7755-8202.4 300301	ATE Ø 9 / 8" pneumatisch
CLS 350	225	01/11→08/14					
CLS 350 CDI / d	195	01/11→08/14					
CLS 350 CDI / d 4-matic	195	09/11→08/14					
CLS 350 d 4-matic	190	04/15→12/17					
CLS 500	300	02/11→12/17					
CLS 500 4-matic	300	09/11→12/17					
CLS 63 AMG	410	01/11→12/17					
CLS 63 AMG	386	01/11→12/17		03/11→; für Linkslenker		03.7755-8202.4 300301	ATE Ø 9 / 8" pneumatisch
 Hauptbremszylinder							
CLS 220 BlueTEC / d	120 - 130	05/14→12/17		für Linkslenker		03.2126-3196.3 010968	ATE Ø 27
CLS 250 BlueTEC / d 4-matic	150	05/14→12/17					
CLS 250 CDI / BlueTEC / d	150	04/11→12/17					
CLS 350	225	01/11→08/14					
CLS 350 BlueTEC / d	185 - 190	02/13→12/17					
CLS 350 BlueTEC / d 4-matic	185	02/13→12/17					
CLS 350 CDI / d	195	01/11→08/14					
CLS 350 CDI / d 4-matic	195	09/11→08/14					
CLS 350 d 4-matic	190	04/15→12/17					
CLS 400	245	05/14→12/17					
CLS 400 4-matic	245	05/14→12/17					
CLS 500	300	02/11→12/17					
CLS 500 4-matic	300	09/11→12/17					
CLS 63 AMG	410 - 430	01/11→12/17					
CLS 63 AMG 4-matic	410 - 430	02/13→12/17					
CLS 63 AMG	386	01/11→12/17		03/11→; für Linkslenker		03.2126-3196.3 010968	ATE Ø 27
MERCEDES-BENZ - CLS (C219) 10/04→02/11							
 Hauptbremszylinder							
CLS 280	170	07/08→12/10		→ 10/10; für Linkslenker		24.2125-1745.3 010998	TRW Ø 25,4
CLS 300	170	04/09→12/10					
CLS 350	200 - 215	10/04→12/10		→ 10/10; für Rechtslenker		24.2125-1748.3 011030	TRW Ø 25,4
CLS 350 CDI	165 - 200	04/09→12/10					
CLS 500	225 - 285	10/04→12/10					
CLS 55 AMG	350	01/05→12/10					
CLS 63 AMG	378	04/06→12/10					
CLS 320 CDI	155 - 165	01/05→12/10		05/05→ 10/10; für Linkslenker		24.2125-1745.3 010998	TRW Ø 25,4
				05/05→ 10/10; für Rechtslenker		24.2125-1748.3 011030	TRW Ø 25,4
CLS 55 AMG	350	09/05→12/06		für Linkslenker		24.2125-1745.3 010998	TRW Ø 25,4
				für Rechtslenker		24.2125-1748.3 011030	TRW Ø 25,4
MERCEDES-BENZ - CLS (C257) 12/17→							
 Hauptbremszylinder							
AMG CLS 53 EQ Boost 4-matic+	320	05/18→		für Linkslenker		24.4156-1221.3 011127	ATE Ø 27 ohne Bremsflüssigkeitsbehälter
CLS 220 d	143	06/18→					
CLS 300 d	180	04/18→					
CLS 300 d 4-matic	195	04/21→					
CLS 350 d	210	08/18→					
CLS 350 d 4-matic	183 - 210	12/17→					
CLS 350 EQ Boost	220	08/18→					
CLS 350 EQ Boost 4-matic	220	08/18→					
CLS 400 d 4-matic	243 - 250	12/17→					
CLS 450 EQ Boost 4-matic	270	12/17→					
MERCEDES-BENZ - CLS Shooting Brake (X218) 10/12→12/17							
 Bremskraftverstärker							
CLS 250 CDI / BlueTEC / d	150	10/12→12/17		→ A 26541; für Linkslenker		03.7858-1932.4 300263	ATE Ø 9 / 8" pneumatisch
CLS 350	225	10/12→08/14					
CLS 350 CDI / d	195	10/12→08/14					

	kW					! #		
MERCEDES-BENZ - CLS Shooting Brake (X218) 10/12→12/17								
 Bremskraftverstärker								
CLS 350 CDI / d 4-matic	195	10/12→08/14		→ A 26541; für Linkslenker			03.7858-1932.4 300263	ATE Ø 9 / 8" pneumatisch
 Hauptbremszylinder								
CLS 220 BlueTEC / d	120 - 130	05/14→12/17		für Linkslenker			03.2126-3196.3 010968	ATE Ø 27
CLS 250 BlueTEC / d 4-matic	150	05/14→12/17						
CLS 250 CDI / BlueTEC / d	150	10/12→12/17						
CLS 350	225	10/12→08/14						
CLS 350 BlueTEC / d	185 - 190	05/14→12/17						
CLS 350 BlueTEC / d 4-matic	185	05/14→12/17						
CLS 350 CDI / d	195	10/12→08/14						
CLS 350 CDI / d 4-matic	195	10/12→08/14						
CLS 350 d 4-matic	190	04/15→12/17						
CLS 400	245	05/14→12/17						
CLS 400 4-matic	245	05/14→12/17						
CLS 500	300	10/12→12/17						
CLS 500 4-matic	300	10/12→12/17						
CLS 63 AMG	386 - 430	10/12→12/17						
CLS 63 AMG 4-matic	410 - 430	02/13→12/17						
MERCEDES-BENZ - E-KLASSE (W210) 06/95→08/03								
 Hauptbremszylinder								
E 200	100	06/95→08/00		→ A394035			03.2023-1066.3 010032	Ø1 23,8 Ø2 19
E 290 Turbo-D	95	03/96→07/99		A394036→			03.2023-1812.3 010570	Ø1 23,8 Ø2 19
E 200 CDI	75	06/98→03/02		07/98→			03.2023-1812.3 010570	Ø1 23,8 Ø2 19
E 220 CDI	92	06/98→07/99						
E 200 CDI	85	07/99→03/02					03.2023-1812.3 010570	Ø1 23,8 Ø2 19
E 220 CDI	100 - 105	07/99→03/02						
E 200 D	65	01/96→03/02		10/96→; → A394035			03.2023-1066.3 010032	Ø1 23,8 Ø2 19
				A394036→			03.2023-1812.3 010570	Ø1 23,8 Ø2 19
E 200 Kompressor	137	06/97→03/02		09/97→			24.2025-1703.3 010516	Ø1 25,4 Ø2 19
E 430	205	06/97→03/02						
E 55 AMG	260	08/97→03/02						
E 200 Kompressor	120	08/00→03/02					24.2025-1703.3 010516	Ø1 25,4 Ø2 19
E 270 CDI	120 - 125	07/99→03/02						
E 280	150	12/96→03/02						
E 280 4-matic	150	12/96→03/02						
E 300 Turbo-D	130	12/96→07/99						
E 320	165	06/97→03/02						
E 320 4-matic	165	06/97→03/02						
E 320 CDI	145	07/99→03/02						
E 430 4-matic	205	05/99→03/02						
E 220 D	55 - 70	06/95→03/02		→ A394035			03.2023-1066.3 010032	Ø1 23,8 Ø2 19
				→ 06/98; A394036→			03.2023-1812.3 010570	Ø1 23,8 Ø2 19
E 240	125	06/97→08/00		09/97→; - ESP			03.2023-1812.3 010570	Ø1 23,8 Ø2 19
				09/97→; + ESP			24.2025-1703.3 010516	Ø1 25,4 Ø2 19
E 240	125	08/00→03/02		- ESP			03.2023-1812.3 010570	Ø1 23,8 Ø2 19
				+ ESP			24.2025-1703.3 010516	Ø1 25,4 Ø2 19
E 250 D	83	06/95→07/99		→ A394035			03.2023-1066.3 010032	Ø1 23,8 Ø2 19
				→ A394035; für Rechtslenker			03.2023-1066.3 010032	Ø1 23,8 Ø2 19
				A394036→			03.2023-1812.3 010570	Ø1 23,8 Ø2 19
				A394036→; für Rechtslenker			03.2023-1812.3 010570	Ø1 23,8 Ø2 19
E 250 Turbo-D	110	06/97→07/99		09/97→			03.2023-1812.3 010570	Ø1 23,8 Ø2 19
MERCEDES-BENZ - E-KLASSE (W211) 03/02→03/09								
 Hauptbremszylinder								
E 200 CDI	75 - 100	07/02→12/08		für Linkslenker			24.2125-1745.3 010998	TRW Ø 25,4
E 200 Kompressor	120 - 135	11/02→12/08		für Rechtslenker			24.2125-1748.3 011030	TRW Ø 25,4
E 200 NGT	120	03/04→12/08						
E 220 CDI	100 - 125	03/02→12/08						
E 230	150	09/07→12/08						
E 240	130	03/02→12/08						
E 240 4-matic	130	03/03→12/08						
→								

	kW			 	! #		
MERCEDES-BENZ - E-KLASSE (W211) 03/02→03/09							
 Hauptbremszylinder							
E 270 CDI	120 - 130	03/02→12/08		für Linkslenker		24.2125-1745.3 010998	TRW Ø 25,4
E 280 4-matic	170	01/06→12/08		für Rechtslenker		24.2125-1748.3 011030	TRW Ø 25,4
E 280 CDI	130 - 140	05/04→12/08					
E 280 CDI 4-matic	140	03/05→12/08					
E 300 BlueTEC	155	09/07→12/08					
E 320	165	03/02→12/08					
E 320 4-matic	165	03/03→12/08					
E320 CDI	156	09/06→12/08					
E 320 CDI	150 - 165	11/02→12/08					
E 320 CDI 4-matic	165	03/05→12/08					
E 350	200	03/05→12/08					
E 350 4-matic	200	03/05→12/08					
E 350 CGI	215	09/07→12/08					
E 420 CDI	231	01/06→12/08					
E 500	225 - 285	03/02→12/08					
E 500 4-matic	225 - 285	10/03→12/08					
E 55 AMG Kompressor	350	10/02→12/08					
E 63 AMG	378	03/06→12/08					
E 280	170	03/05→12/08		05/05→; für Linkslenker		24.2125-1745.3 010998	TRW Ø 25,4
				05/05→; für Rechtslenker		24.2125-1748.3 011030	TRW Ø 25,4
E 400 CDI	191	02/03→12/08		03/03→; für Linkslenker		24.2125-1745.3 010998	TRW Ø 25,4
				03/03→; für Rechtslenker		24.2125-1748.3 011030	TRW Ø 25,4
MERCEDES-BENZ - E-KLASSE (W212) 01/09→12/16							
 Bremskraftverstärker							
E 180	115	08/13→12/15		für Linkslenker		03.7755-8202.4 300301	ATE Ø 9 / 8" pneumatisch
E 200	135	01/13→12/16					
E 200 CGI	135	08/09→12/15					
E 200 NGT	115 - 120	03/11→12/15					
E 220 BlueTEC	130	05/14→12/15					
E 220 BlueTEC 4-matic	125	01/15→12/15					
E 250	155	01/13→12/16					
E 250 CDI / BlueTEC 4-matic	150	01/11→12/15					
E 300	185	07/11→12/15					
E 300 4-matic	185	07/11→12/15					
E 350	225	09/11→12/15					
E 350 4-matic	225	09/11→12/15					
E 350 BlueTEC	185 - 190	01/13→12/15					
E 350 BlueTEC 4-matic	185 - 190	01/13→12/15					
E 350 CDI	157 - 195	09/10→12/15					
E 350 CDI 4-matic	170 - 195	09/09→12/15					
E 400	245	01/13→12/16					
E 400 4-matic	245	01/13→12/16					
E 500	300	09/11→12/15					
E 500 4-matic	300	09/11→12/15					
E 63 AMG	386 - 410	12/09→12/16					
E 63 AMG 4-matic	410	01/13→12/16					
E 200 CDI / BlueTEC	100	01/09→12/15		03/09→; für Linkslenker		03.7755-8202.4 300301	ATE Ø 9 / 8" pneumatisch
E 220 CDI	120	01/09→12/15					
E 220 CDI / BlueTEC	125	01/09→12/16					
E 250 CDI / BlueTEC	150	01/09→12/16					
E 250 CGI	150	01/09→12/15					
E 300	170	01/09→12/13					
E 350	200	01/09→12/13					
E 350 4-matic	200	01/09→08/11					
E 350 BlueTEC	155	01/09→12/15					
E 350 CDI	170	01/09→12/15					
E 350 CGI	215	01/09→08/11					
E 500	285	01/09→12/11					
E 500 4-matic	285	01/09→12/11					
E 250	150	05/09→12/11		für Linkslenker; +SA 800		03.7755-8202.4 300301	ATE Ø 9 / 8" pneumatisch
E 300 CDI / BlueTEC	170	03/11→12/15		04/11→; für Linkslenker		03.7755-8202.4 300301	ATE Ø 9 / 8" pneumatisch
E 63 AMG	430	02/13→12/16		04/13→; für Linkslenker		03.7755-8202.4 300301	ATE Ø 9 / 8" pneumatisch
E 63 AMG 4-matic	430	02/13→12/16					
 Hauptbremszylinder							
E 180 →	115	08/13→12/15		für Linkslenker		03.2126-3196.3 010968	ATE Ø 27

MERCEDES-BENZ - E-KLASSE (W212) 01/09→12/16













Hauptbremszylinder











E 200	135	01/13→12/16	für Linkslenker	03.4156-5106.3	010997	ATE Ø 27
E 200 CGI	135	08/09→12/15				
E 200 NGT	115 -	03/11→12/15				
	120					
E 220 BlueTEC	130	05/14→12/15				
E 220 BlueTEC 4-matic	125	01/15→12/15				
E 250	155	01/13→12/16				
E 250 CDI / BlueTEC 4-matic	150	01/11→12/15				
E 250 CGI	150	01/09→12/15				
E 300	185	07/11→12/15				
E 300 4-matic	185	07/11→12/15				
E 350	225	09/11→12/15				
E 350 4-matic	225	09/11→12/15				
E 350 BlueTEC	185 -	01/13→12/15				
	190					
E 350 BlueTEC 4-matic	185 -	01/13→12/15				
	190					
E 350 CDI	157 -	09/10→12/15				
	195					
E 350 CDI 4-matic	170 -	09/09→12/15				
	195					
E 400	245	01/13→12/16				
E 400 4-matic	245	01/13→12/16				
E 500	300	09/11→12/15				
E 500 4-matic	300	09/11→12/15				
E 63 AMG	386 -	12/09→12/16				
	410					
E 63 AMG 4-matic	410	01/13→12/16				
E 200 CDI / BlueTEC	100	01/09→12/15	03/09→; für Linkslenker	03.2126-3196.3	010968	ATE Ø 27
E 220 CDI	120	01/09→12/15		03.4156-5106.3	010997	ATE Ø 27
E 220 CDI / BlueTEC	125	01/09→12/16				
E 250 CDI / BlueTEC	150	01/09→12/16				
E 300	170	01/09→12/13				
E 350	200	01/09→12/13				
E 350 4-matic	200	01/09→08/11				
E 350 BlueTEC	155	01/09→12/15				
E 350 CDI	170	01/09→12/15				
E 350 CGI	215	01/09→08/11				
E 500	285	01/09→12/11				
E 500 4-matic	285	01/09→12/11				
E 250	150	05/09→12/11	für Linkslenker; → SA Code bis: 803	03.2126-3196.3	010968	ATE Ø 27
			für Linkslenker; SA Code ab: 804 →	03.4156-5106.3	010997	ATE Ø 27
E 300 CDI / BlueTEC	170	03/11→12/15	04/11→; für Linkslenker	03.2126-3196.3	010968	ATE Ø 27
				03.4156-5106.3	010997	ATE Ø 27
E 63 AMG	430	02/13→12/16	04/13→; für Linkslenker	03.2126-3196.3	010968	ATE Ø 27
E 63 AMG 4-matic	430	02/13→12/16		03.4156-5106.3	010997	ATE Ø 27











MERCEDES-BENZ - E-KLASSE (W213) 01/16→











Hauptbremszylinder













AMG E 43 4-matic	295	07/16→05/18	für Linkslenker	24.4156-1221.3	011127	ATE Ø 27 ohne Bremsflüssigkeitsbehälter
AMG E 53 EQ Boost 4-matic+	320	04/18→10/23				
E 180	115	01/17→06/19				
E 200	135 -	01/16→10/23				
	145					
E 200 4-matic	135	07/16→06/19				
E 200 d	110	07/16→06/20				
E 200 EQ Boost	145	06/19→10/23				
E 200 EQ Boost 4-matic	145	06/19→10/23				
E 220 d	120 -	01/16→10/23				
	147					
E 220 d 4-matic	120 -	10/16→10/23				
	147					
E 250	155	07/16→10/23				
E 300	180 -	07/16→10/23				
	190					
E 300 4-matic	180	09/16→06/20				
E 300 d	180	12/17→06/20				
E 300 d 4-matic	195	01/21→10/23				
E 300 de	225	10/18→10/23				
E 300 de 4-matic	225	06/20→08/23				
E 300 e	235	11/18→10/23				
E 300 e 4-matic	235	07/20→10/23				
E 300 EQ Boost	190	06/19→10/23				
E 350 d	190 -	01/16→06/20				
	210					
E 350 d 4-matic	190	06/17→05/18				
E 350 e	235	09/16→06/19				
E 350 EQ Boost	220	08/18→10/23				
→						















	kW					! #		
MERCEDES-BENZ - E-KLASSE (W213) 01/16→								
 Hauptbremszylinder								
E 400 4-matic E 400 d E 400 d 4-matic	245 250 243 -	07/16→05/18 12/18→06/20 04/18→10/23		für Linkslenker			24.4156-1221.3 011127	ATE Ø 27 ohne Bremsflüssigkeitsbehälter
E 450 4-matic E 450 EQ Boost 4-matic	250 270	08/18→06/20 07/20→10/23						
AMG E 63 4-matic+ AMG E 63 S 4-matic+	420 450	01/17→11/21 01/17→10/23		für Linkslenker; → A; → 08/17			24.4156-1136.3 011126	ATE Ø 27 ohne Bremsflüssigkeitsbehälter
E 400 4-matic	245	06/16→05/18		07/16→; für Linkslenker			24.4156-1221.3 011127	ATE Ø 27 ohne Bremsflüssigkeitsbehälter
MERCEDES-BENZ - E-KLASSE All-Terrain (S213) 01/17→10/23								
 Hauptbremszylinder								
E 200 EQ Boost E 220 d 4-matic	145 143 -	08/20→08/23 01/17→10/23		für Linkslenker			24.4156-1221.3 011127	ATE Ø 27 ohne Bremsflüssigkeitsbehälter
E 350 d 4-matic E 400 d 4-matic	147 190	06/17→05/18 08/18→10/23						
E 450 EQ Boost	243 - 250 270	08/18→10/23 08/20→08/23						
MERCEDES-BENZ - E-KLASSE Cabriolet (A207) 01/10→12/16								
 Bremskraftverstärker								
E 200 E 220 BlueTEC E 250 E 300 E 320 E 350	135 130 155 185 200	03/13→12/16 05/14→12/16 06/13→12/16 04/11→12/16 07/14→12/16		für Linkslenker; für Fahrzeuge ohne Start-Stopp-Funktion			03.7745-6302.4 300261	ATE Ø 8" pneumatisch
E 350 BlueTEC/ d E 350 BlueTEC E 350 CDI E 350 CGI E 400 E 500	200 - 225 190 185 195 215	03/10→12/14 05/14→12/16 06/13→12/16 04/11→12/13 01/10→12/14		für Linkslenker; für Fahrzeuge mit Start-Stopp-Funktion			03.7745-8902.4 300297	ATE Ø 8" pneumatisch
E 200 CGI E 220 CDI / BlueTEC / d E 220 CDI E 250 CDI / BlueTEC / d E 250 CGI E 350 CDI E 500	135 125 120 150 150 170 285	01/10→12/16 01/10→12/16 02/10→12/16 01/10→12/16 01/10→12/16 01/10→12/11 01/10→12/11		03/10→; für Linkslenker; für Fahrzeuge ohne Start-Stopp-Funktion			03.7745-6302.4 300261	ATE Ø 8" pneumatisch
				03/10→; für Linkslenker; für Fahrzeuge mit Start-Stopp-Funktion			03.7745-8902.4 300297	ATE Ø 8" pneumatisch
 Hauptbremszylinder								
E 200 E 220 BlueTEC E 250 E 300 E 320 E 350	135 130 155 185 200	03/13→12/16 05/14→12/16 06/13→12/16 04/11→12/16 07/14→12/16		für Linkslenker			03.2025-2521.3 010959	ATE Ø1 25,4 Ø2 22,2
E 350 BlueTEC/ d E 350 BlueTEC E 350 CDI E 350 CGI E 400 E 500	200 - 225 190 185 195 215	03/10→12/14 05/14→12/16 06/13→12/16 04/11→12/13 01/10→12/14		für Rechtslenker			24.2025-2311.3 011023	ATE Ø1 25,4 Ø2 20,6
E 200 CGI E 220 CDI / BlueTEC / d E 220 CDI E 250 CDI / BlueTEC / d E 250 CGI E 350 CDI E 500	135 125 120 150 150 170 285	01/10→12/16 01/10→12/16 02/10→12/16 01/10→12/16 01/10→12/16 01/10→12/11 01/10→12/11		03/10→; für Linkslenker			03.2025-2521.3 010959	ATE Ø1 25,4 Ø2 22,2
				03/10→; für Rechtslenker			24.2025-2311.3 011023	ATE Ø1 25,4 Ø2 20,6
MERCEDES-BENZ - E-KLASSE Cabriolet (A238) 06/17→								
 Hauptbremszylinder								
AMG E53 EQ Boost 4-matic+ E 200 E 200 4-matic E 200 EQ Boost E 200 EQ Boost 4-matic E 220 d E 220 d 4-matic →	320 135 135 145 145 120 - 143 143	05/18→ 06/17→ 10/17→ 06/19→ 06/19→ 06/17→ 10/17→		für Linkslenker			24.4156-1221.3 011127	ATE Ø 27 ohne Bremsflüssigkeitsbehälter











	kw					! #		
MERCEDES-BENZ - E-KLASSE Cabriolet (A238) 06/17→								
 Hauptbremszylinder								
E 300	180	06/17→		für Linkslenker		24.4156-1221.3	011127	ATE Ø 27 ohne Bremsflüssigkeitsbehälter
E 300 d	180	05/18→						
E 300 d 4-matic	195	04/21→						
E 300 EQ Boost	190	06/19→						
E 350 d	210	11/18→						
E 350 d 4-matic	190	06/17→						
E 350 EQ Boost	220	10/17→						
E 400 4-matic	245	06/17→						
E 400 d 4-matic	243	08/18→						
	250							
E 450 4-matic	270	08/18→						
E 450 EQ Boost 4-matic	270	07/20→						
MERCEDES-BENZ - E-KLASSE Coupe (C207) 01/09→12/16								
 Bremskraftverstärker								
E 200	135	06/13→12/16		für Linkslenker; für Fahrzeuge ohne Start-Stopp-Funktion		03.7745-6302.4	300261	ATE Ø 8" pneumatisch
E 200 CGI	135	01/10→12/16						
E 220 BlueTEC	130	05/14→12/16						
E 220 CDI / d	125	01/10→12/16		für Linkslenker; für Fahrzeuge mit Start-Stopp-Funktion		03.7745-8902.4	300297	ATE Ø 8" pneumatisch
E 220 CDI	120	02/10→12/14						
E 250	155	06/13→12/16						
E 300	185	04/11→06/16						
E 320	200	07/14→12/16						
E 350	225	04/11→12/14						
E 350 4-matic	225	02/13→12/16						
E 350 BlueTEC / d	190	05/14→12/16						
E 350 BlueTEC	185	06/13→12/16						
E 350 CDI	195	06/11→06/13						
E 400	245	06/13→12/16						
E 500	300	09/11→12/16						
E 250 CDI / BlueTEC / d	150	01/09→12/16		05/09→; für Linkslenker; für Fahrzeuge ohne Start-Stopp-Funktion		03.7745-6302.4	300261	ATE Ø 8" pneumatisch
E 250 CGI	150	01/09→12/16						
E 350 CDI	170	01/09→06/11		05/09→; für Linkslenker; für Fahrzeuge mit Start-Stopp-Funktion		03.7745-8902.4	300297	ATE Ø 8" pneumatisch
E 350 CGI	215	01/09→12/11						
E 500	285	01/09→12/16						
 Hauptbremszylinder								
E 200	135	06/13→12/16		für Linkslenker		03.2025-2521.3	010959	ATE Ø1 25,4 Ø2 22,2
E 200 CGI	135	01/10→12/16						
E 220 BlueTEC	130	05/14→12/16		für Rechtslenker		24.2025-2311.3	011023	ATE Ø1 25,4 Ø2 20,6
E 220 CDI / d	125	01/10→12/16						
E 220 CDI	120	02/10→12/14						
E 250	155	06/13→12/16						
E 300	185	04/11→06/16						
E 320	200	07/14→12/16						
E 350	225	04/11→12/14						
E 350 4-matic	225	02/13→12/16						
E 350 BlueTEC / d	190	05/14→12/16						
E 350 BlueTEC	185	06/13→12/16						
E 350 CDI	195	06/11→06/13						
E 400	245	06/13→12/16						
E 500	300	09/11→12/16						
E 250 CDI / BlueTEC / d	150	01/09→12/16		05/09→; für Linkslenker		03.2025-2521.3	010959	ATE Ø1 25,4 Ø2 22,2
E 250 CGI	150	01/09→12/16						
E 350 CDI	170	01/09→06/11		05/09→; für Rechtslenker		24.2025-2311.3	011023	ATE Ø1 25,4 Ø2 20,6
E 350 CGI	215	01/09→12/11						
E 500	285	01/09→12/16						
MERCEDES-BENZ - E-KLASSE Coupe (C238) 12/16→								
 Hauptbremszylinder								
AMG E 53 EQ Boost 4-matic+	320	05/18→		für Linkslenker		24.4156-1221.3	011127	ATE Ø 27 ohne Bremsflüssigkeitsbehälter
E 200	135	12/16→						
E 200 4-matic	135	06/17→						
E 200 EQ Boost	145	06/19→						
E 200 EQ Boost 4-matic	145	06/19→						
E 220 d	120	12/16→						
	143							
E 220 d 4-matic	143	03/17→						
E 300	180	12/16→						
	190							
E 300 d	180	05/18→						
E 300 d 4-matic	195	01/21→						
E 300 EQ Boost	190	06/19→						
E 350 d	210	11/18→						
E 350 d 4-matic	190	06/17→						
E 350 EQ Boost	220	10/17→						
E 400 4-matic	245	12/16→						
→								

	kw					! #		
MERCEDES-BENZ - E-KLASSE Coupe (C238) 12/16→								
 Hauptbremszylinder								
E 400 d 4-matic	243	08/18→		für Linkslenker		24.4156-1221.3	011127	ATE Ø 27 ohne Bremsflüssigkeitsbehälter
E 450 4-matic	250	08/18→						
E 450 EQ Boost 4-matic	270	07/20→						
MERCEDES-BENZ - E-KLASSE Pritsche/Fahrgestell (VF211) 03/03→07/09								
 Hauptbremszylinder								
E 220 CDI	110 - 125	10/03→07/09		für Linkslenker; +SA 807/808 / 809		24.2125-1745.3	010998	TRW Ø 25,4
E 270 CDI	120 - 130	03/03→07/09		für Rechtslenker; +SA 807/808 / 809		24.2125-1748.3	011030	TRW Ø 25,4
E 280 CDI	140	08/05→07/09						
MERCEDES-BENZ - E-KLASSE T-Model (S210) 06/96→03/03								
 Hauptbremszylinder								
E 200 T	100	06/96→08/00		→ A394035		03.2023-1066.3	010032	Ø1 23,8 Ø2 19
				A394036→		03.2023-1812.3	010570	Ø1 23,8 Ø2 19
E 200 T Kompressor	137	06/97→03/03		09/97→		24.2025-1703.3	010516	Ø1 25,4 Ø2 19
E 250 T Turbo-D	110	06/97→07/99						
E 430 T	205	06/97→03/03						
E 55 T AMG	260	08/97→03/03						
E 200 T Kompressor	120	08/00→03/03				24.2025-1703.3	010516	Ø1 25,4 Ø2 19
E 270 T CDI	120 - 125	07/99→03/03						
E 280 T 4-matic	150	12/96→03/03						
E 300 T Turbo-D	130	12/96→07/99						
E 320 T	165	12/96→03/03						
E 320 T CDI	145	07/99→03/03						
E 430 T 4-matic	205	05/99→03/03						
E 220 T CDI	100 - 105	05/99→03/03		für Linkslenker; Radstand [mm]: 2.833		03.2023-1812.3	010570	Ø1 23,8 Ø2 19
				für Linkslenker; Radstand [mm]: 3.570		24.2025-1703.3	010516	Ø1 25,4 Ø2 19
E 220 T CDI	92	06/98→07/99		07/98→; für Linkslenker; Radstand [mm]: 2.833		03.2023-1812.3	010570	Ø1 23,8 Ø2 19
				07/98→; für Linkslenker; Radstand [mm]: 3.570		24.2025-1703.3	010516	Ø1 25,4 Ø2 19
E 240 T	125	06/97→03/03		09/97→; - ESP		03.2023-1812.3	010570	Ø1 23,8 Ø2 19
				09/97→; + ESP		24.2025-1703.3	010516	Ø1 25,4 Ø2 19
E 240 T	125	08/00→03/03		- ESP		03.2023-1812.3	010570	Ø1 23,8 Ø2 19
				+ ESP		24.2025-1703.3	010516	Ø1 25,4 Ø2 19
E 250 T D	83	06/96→07/99		→ A394035; für Rechtslenker; Radstand [mm]: 2.833		03.2023-1066.3	010032	Ø1 23,8 Ø2 19
				→ A394035; Radstand [mm]: 2.833		03.2023-1066.3	010032	Ø1 23,8 Ø2 19
				→ A394035; Radstand [mm]: 3.570		24.2025-1702.3	010515	Ø1 25,4 Ø2 19
				A394036→; Radstand [mm]: 2.833		24.2025-1703.3	010516	Ø1 25,4 Ø2 19
				A394036→; für Rechtslenker; Radstand [mm]: 2.833		24.2025-1703.3	010516	Ø1 25,4 Ø2 19
				A394036→; Radstand [mm]: 3.570		24.2025-1703.3	010516	Ø1 25,4 Ø2 19
E 280 T	150	12/96→03/03		Radstand [mm]: 3.570		24.2025-1703.3	010516	Ø1 25,4 Ø2 19
E 290 T Turbo-D	95	06/96→07/99		→ A394035; Radstand [mm]: 2.833		03.2023-1066.3	010032	Ø1 23,8 Ø2 19
				→ A394035; Radstand [mm]: 3.570		24.2025-1702.3	010515	Ø1 25,4 Ø2 19
				A394036→		24.2025-1703.3	010516	Ø1 25,4 Ø2 19
E 320 T 4-matic	165	12/96→03/03		06/97→		24.2025-1703.3	010516	Ø1 25,4 Ø2 19
MERCEDES-BENZ - E-KLASSE T-Model (S211) 02/03→07/09								
 Hauptbremszylinder								
350 CGI	215	05/06→07/09		für Linkslenker		24.2125-1745.3	010998	TRW Ø 25,4
E 200 CDI	100	04/06→07/09						
E 200 Kompressor	135	04/06→07/09						
E 200 T Kompressor	120	03/03→07/09						
E 220 CDI	100	03/03→07/09						
E 220 T CDI	110 - 125	03/03→07/09						
E 230 T	150	05/07→07/09						
E 240 T	130	03/03→07/09						
E 240 T 4-matic	130	07/03→07/09						
E 270 T CDI	120 - 130	03/03→07/09						
E 280 T CDI	130 - 140	05/04→07/09						
E 320 T	165	03/03→07/09						
E 320 T 4-matic	165	07/03→07/09						
→								











	kw			 	! #		
MERCEDES-BENZ - E-KLASSE T-Model (S211) 02/03→07/09							
 Hauptbremszylinder							
E 320 T CDI	150 - 165	03/03→07/09		für Linkslenker		24.2125-1745.3 010998	TRW Ø 25,4
E 350 T	200	03/05→07/09					
E 350 T 4-matic	200	03/05→07/09					
E 500 T	225 - 285	10/03→07/09					
E 500 T 4-matic	225 - 285	10/03→07/09					
E 55 T AMG Kompressor	350	07/03→07/09					
E 63 AMG	378	03/06→07/09					
E 280 T	170	03/05→07/09		05/05→; für Linkslenker		24.2125-1745.3 010998	TRW Ø 25,4
E 280 T 4-matic	170	03/05→07/09					
E 280 T CDI 4-matic	140	03/05→07/09					
E 320 T CDI 4-matic	165	03/05→07/09					
MERCEDES-BENZ - E-KLASSE T-Model (S212) 08/09→12/16							
 Bremskraftverstärker							
E 200	135	11/12→12/16		03/13→; für Linkslenker		03.7755-8202.4 300301	ATE Ø 9 / 8" pneumatisch
E 250	155	11/12→12/16					
E 200 CDI / BlueTEC	100	11/09→12/16		für Linkslenker		03.7755-8202.4 300301	ATE Ø 9 / 8" pneumatisch
E 200 CGI	135	11/09→12/16					
E 220 BlueTEC	130	05/15→12/16					
E 220 BlueTEC 4-matic	125	12/14→12/16					
E 220 CDI / BlueTEC	125	11/09→12/16					
E 250 CDI / BlueTEC	150	11/09→12/16					
E 250 CDI / BlueTEC 4-matic	150	07/10→12/16					
E 250 CGI	150	11/09→12/13					
E 300	170 - 185	11/09→12/16					
E 300 4-matic	185	07/11→12/16					
E 300 CDI / BlueTEC	170	11/09→12/16					
E 350	225	09/11→12/14					
E 350 4-matic	200 - 225	11/09→12/16					
E 350 BlueTEC	155 - 190	11/09→12/16					
E 350 BlueTEC 4-matic	190	07/14→12/16					
E 350 CDI	170 - 195	11/09→12/13					
E 350 CDI 4-matic	170 - 195	11/09→12/13					
E 350 CGI	215	11/09→12/11					
E 400	245	01/13→12/16					
E 400 4-matic	245	01/13→12/16					
E 500	285 - 300	11/09→12/16					
E 500 4-matic	300	09/11→12/16					
E 63 AMG	386 - 410	02/11→12/16					
E 63 AMG 4-matic	410	02/11→12/16					
E 220 CDI	120	08/09→08/14		11/09→; für Linkslenker		03.7755-8202.4 300301	ATE Ø 9 / 8" pneumatisch
E 350	200	08/09→12/11					
E 63 AMG	386	08/09→12/11					
E 350 BlueTEC	185	11/12→12/16		01/13→; für Linkslenker		03.7755-8202.4 300301	ATE Ø 9 / 8" pneumatisch
E 350 BlueTEC 4-matic	185	11/12→12/16					
E 63 AMG	430	02/13→12/16		04/13→; für Linkslenker		03.7755-8202.4 300301	ATE Ø 9 / 8" pneumatisch
E 63 AMG 4-matic	430	02/13→12/16					
 Hauptbremszylinder							
E 200	135	11/12→12/16		03/13→; für Linkslenker		03.2126-3196.3 010968	ATE Ø 27
E 250	155	11/12→12/16				03.4156-5106.3 010997	ATE Ø 27
E 200 CDI / BlueTEC	100	11/09→12/16		für Linkslenker		03.2126-3196.3 010968	ATE Ø 27
E 200 CGI	135	11/09→12/16				03.4156-5106.3 010997	ATE Ø 27
E 220 BlueTEC	130	05/15→12/16					
E 220 BlueTEC 4-matic	125	12/14→12/16					
E 220 CDI / BlueTEC	125	11/09→12/16					
E 250 CDI / BlueTEC	150	11/09→12/16					
E 250 CDI / BlueTEC 4-matic	150	07/10→12/16					
E 250 CGI	150	11/09→12/13					
E 300	170 - 185	11/09→12/16					
E 300 4-matic	185	07/11→12/16					
E 300 CDI / BlueTEC	170	11/09→12/16					
E 350	225	09/11→12/14					
E 350 4-matic	200 - 225	11/09→12/16					
→							











	kW					! #		
MERCEDES-BENZ - E-KLASSE T-Model (S212) 08/09→12/16								
 Hauptbremszylinder								
E 350 BlueTEC	155 - 190	11/09→12/16		für Linkslenker		03.2126-3196.3	010968	ATE Ø 27
E 350 BlueTEC 4-matic	190	07/14→12/16				03.4156-5106.3	010997	ATE Ø 27
E 350 CDI	170 - 195	11/09→12/13						
E 350 CDI 4-matic	170 - 195	11/09→12/13						
E 350 CGI	215	11/09→12/11						
E 400	245	01/13→12/16						
E 400 4-matic	245	01/13→12/16						
E 500	285 - 300	11/09→12/16						
E 500 4-matic	300	09/11→12/16						
E 63 AMG	386 - 410	02/11→12/16						
E 63 AMG 4-matic	410	02/11→12/16						
E 220 CDI	120	08/09→08/14		11/09→; für Linkslenker		03.2126-3196.3	010968	ATE Ø 27
E 350	200	08/09→12/11				03.4156-5106.3	010997	ATE Ø 27
E 63 AMG	386	08/09→12/11						
E 350 BlueTEC	185	11/12→12/16		01/13→; für Linkslenker		03.2126-3196.3	010968	ATE Ø 27
E 350 BlueTEC 4-matic	185	11/12→12/16				03.4156-5106.3	010997	ATE Ø 27
E 63 AMG	430	02/13→12/16		04/13→; für Linkslenker		03.2126-3196.3	010968	ATE Ø 27
E 63 AMG 4-matic	430	02/13→12/16				03.4156-5106.3	010997	ATE Ø 27
MERCEDES-BENZ - E-KLASSE T-Model (S213) 07/16→10/23								
 Hauptbremszylinder								
AMG E 43 4-matic	295	10/16→05/18		für Linkslenker		24.4156-1221.3	011127	ATE Ø 27 ohne Bremsflüssigkeitsbehälter
AMG E 53 EQ Boost 4-matic+	320	04/18→10/23						
E 200	135	07/16→06/20						
E 200 4-matic	135	01/17→06/19						
E 200 d	110 - 118	10/16→08/23						
E 200 EQ Boost	145	06/19→10/23						
E 200 EQ Boost 4-matic	145	06/19→10/23						
E 220 d	120 - 147	07/16→10/23						
E 220 d 4-matic	143 - 147	01/17→10/23						
E 250	155	07/16→11/18						
E 300 d	180	12/17→06/20						
E 300 d 4-matic	195	01/21→10/23						
E 300 de	225	10/18→10/23						
E 300 de 4-matic	225	08/20→08/23						
E 300 e	235	06/20→08/23						
E 300 EQ Boost	190	06/19→10/23						
E 350 d	190 - 210	10/16→06/20						
E 350 d 4-matic	190	06/17→05/18						
E 400 4-matic	245	10/16→05/18						
E 400 d	250	02/19→06/20						
E 400 d 4-matic	243 - 250	04/18→10/23						
E 450 4-matic	270	08/18→06/20						
E 450 EQ Boost	270	08/20→08/23						
AMG E 63 4-matic+	420	05/17→10/23		für Linkslenker; → A; → 08/17		24.4156-1136.3	011126	ATE Ø 27 ohne Bremsflüssigkeitsbehälter
AMG E 63 S 4-matic+	450	05/17→10/23						
MERCEDES-BENZ - EQC (N293) 05/19→07/23								
 Hauptbremszylinder								
EQC 400 4-matic	300	05/19→07/23		für Linkslenker		24.4156-1221.3	011127	ATE Ø 27 ohne Bremsflüssigkeitsbehälter
MERCEDES-BENZ - eSPRINTER Kasten (B910) 02/20→								
 Hauptbremszylinder								
Electric	85	02/20→				24.2126-1708.3	011128	Ø 27 ohne Bremsflüssigkeitsbehälter
MERCEDES-BENZ - G-KLASSE (W461) 09/89→								
 Bremskraftverstärker								
230 GE	92	06/93→07/00		für Linkslenker		03.6855-1402.4	300057	ATE Ø 9" pneumatisch
290 GD/G 290 D	70	06/93→07/00						
G 270 CDI	115	01/03→12/06		für Rechtslenker		03.6855-1902.4	300059	ATE Ø 9" pneumatisch
G 290 TD	88	07/97→07/01						
G 280 CDI	135	04/09→		für Linkslenker		03.6855-1402.4	300057	ATE Ø 9" pneumatisch
G 300 CDI	135	04/10→07/23						









	kw			 	! #		
MERCEDES-BENZ - G-KLASSE (W461) 09/89→							
 Hauptbremszylinder							
230 GE	92	06/93→07/00				03.2125-2102.3 010207	Ø 25,4
290 GD/G 290 D	70	06/93→07/00					
G 290 TD	88	07/97→07/01					
G 270 CDI	115	01/03→12/06		für Rechtslenker		03.2125-2102.3 010207	Ø 25,4
MERCEDES-BENZ - G-KLASSE (W463) 09/89→12/18							
 Bremskraftverstärker							
G 270 CDI	115	10/01→07/03		für Linkslenker		03.6855-1402.4 300057	ATE Ø 9" pneumatisch
G 300 TD	130	08/96→07/00		für Rechtslenker		03.6855-1902.4 300059	ATE Ø 9" pneumatisch
G 320	158	07/97→08/04					
G 400 CDI	184	12/00→07/06					
G 500	218	04/98→12/15					
G 55 AMG	260 - 373	04/99→12/12					
 Hauptbremszylinder							
G 270 CDI	115	10/01→07/03		für Linkslenker; - ABS		03.2125-2102.3 010207	Ø 25,4
G 300 TD	130	08/96→07/00					
G 320	158	07/97→08/04					
G 400 CDI	184	12/00→07/06					
G 500	218	04/98→12/15					
G 55 AMG	260 - 373	04/99→12/12					
G 320 CDI	165	09/06→12/12				24.2125-1745.3 010998	TRW Ø 25,4
G 350 CDI	155	07/11→08/15					
G 500	285	05/08→08/15		→ 12/11		24.2125-1745.3 010998	TRW Ø 25,4
MERCEDES-BENZ - G-KLASSE Cabrio (W463) 09/89→02/18							
 Bremskraftverstärker							
G 300 TD	130	09/96→07/00		für Linkslenker		03.6855-1402.4 300057	ATE Ø 9" pneumatisch
G 320	158	11/97→08/04		für Rechtslenker		03.6855-1902.4 300059	ATE Ø 9" pneumatisch
G 400 CDI	184	12/00→07/06					
G 500	218 - 285	04/98→12/15					
 Hauptbremszylinder							
G 300 TD	130	09/96→07/00		für Linkslenker; - ABS		03.2125-2102.3 010207	Ø 25,4
G 320	158	11/97→08/04					
G 400 CDI	184	12/00→07/06					
G 500	218 - 285	04/98→12/15					
G 320 CDI	165	09/06→12/12				24.2125-1745.3 010998	TRW Ø 25,4
G 350 CDI	155	07/11→12/15					
MERCEDES-BENZ - GLA-KLASSE (X156) 12/13→05/22							
 Hauptbremszylinder							
AMG GLA 45 4-matic	280	07/15→06/19		für Linkslenker		24.4123-1718.3 011016	TRW Ø 23,8 ohne Bremsflüssigkeitsbehälter
GLA 180	90	02/15→12/19					
GLA 180 CDI / d	80	07/14→05/18					
GLA 200	110 - 115	12/13→12/19					
GLA 200 CDI / d	100	12/13→12/19					
GLA 200 CDI 4-matic	100	12/13→05/19					
GLA 220 4-matic	135	01/17→12/19					
GLA 220 CDI / d	120	12/13→05/19					
GLA 220 CDI / d 4-matic	120	12/13→12/19					
GLA 220 CDI	125	12/13→05/19					
GLA 220 CDI 4-matic	125	12/13→12/19					
GLA 220 d	130	07/15→05/19					
GLA 220 d 4-matic	130	07/15→12/19					
GLA 250	155	12/13→12/19					
GLA 250 4-matic	155	12/13→12/19					
GLA 250 Flex	155	01/15→12/19					
GLA 45 AMG 4-matic	265	05/14→06/19					
MERCEDES-BENZ - GLC (X253) 06/15→06/22							
 Hauptbremszylinder							
200 d	120	04/19→06/22		für Linkslenker		24.4156-1221.3 011127	ATE Ø 27 ohne Bremsflüssigkeitsbehälter
200 d 4-matic	120	04/19→06/22					
200 EQ Boost	145	04/19→06/22					
200 EQ Boost 4-matic	145	04/19→06/22					
220 d	143	04/19→06/22					
220 d 4-matic	143	04/19→06/22					
300 d 4-matic	180	04/19→06/22					
300 de 4-matic	225	05/20→06/22					
300 EQ Boost 4-matic	190	04/19→06/22					
→							











	kW					! #		
MERCEDES-BENZ - GLC (X253) 06/15→06/22								
 Hauptbremszylinder								
400 d 4-matic AMG 43 4-matic F-CELL	243 287 80 - 155	08/19→06/22 08/19→06/22 10/18→04/20		für Linkslenker			24.4156-1221.3 011127	ATE Ø 27 ohne Bremsflüssigkeitsbehälter
220 d 4-matic 250 4-matic 250 CNG 4-matic 250 d 4-matic 250 Flexfuel 4-matic 300 4-matic 350 d 4-matic 350 e 4-matic AMG 43 4-matic 300	120 - 125 155 155 150 155 180 190 235 270 180	06/15→04/19 06/15→04/19 06/15→04/19 06/15→04/19 06/15→04/19 07/15→04/19 10/16→04/19 01/16→04/19 04/16→08/19 01/16→04/19		für Linkslenker			24.4156-1136.3 011126	ATE Ø 27 ohne Bremsflüssigkeitsbehälter
				für Linkslenker; +SA 806/807 / 808/809			24.4156-1136.3 011126	ATE Ø 27 ohne Bremsflüssigkeitsbehälter
				für Linkslenker			24.4156-1221.3 011127	ATE Ø 27 ohne Bremsflüssigkeitsbehälter
300 e 4-matic	235	11/19→06/22		für Linkslenker; → Modelljahr bis: 2019			24.4156-1136.3 011126	ATE Ø 27 ohne Bremsflüssigkeitsbehälter
				für Linkslenker			24.4156-1221.3 011127	ATE Ø 27 ohne Bremsflüssigkeitsbehälter
AMG 63 4-matic+ AMG 63 S 4-matic+	350 375	06/17→06/22 06/17→06/22		für Linkslenker; +SA 806/807			24.4156-1136.3 011126	ATE Ø 27 ohne Bremsflüssigkeitsbehälter
MERCEDES-BENZ - GLC Coupe (C253) 06/16→03/23								
 Hauptbremszylinder								
200 d 200 d 4-matic 200 EQ Boost 200 EQ Boost 4-matic 220 d 4-matic 260 4-matic 300 4-matic 300 d 4-matic 300 de 4-matic 300 EQ Boost 4-matic 400 d 4-matic AMG 43 4-matic	120 120 145 145 143 145 190 180 225 190 243 287	04/19→08/21 04/19→03/23 04/19→03/23 04/19→03/23 04/19→03/23 11/19→03/23 11/19→03/23 04/19→03/23 05/20→03/23 04/19→03/23 08/19→03/23 08/19→03/23		für Linkslenker			24.4156-1221.3 011127	ATE Ø 27 ohne Bremsflüssigkeitsbehälter
220 d 4-matic 250 4-matic 250 d 4-matic 300 4-matic 350 d 4-matic 350 e 4-matic AMG 43 4-matic	120 - 125 155 150 180 190 235 270	06/16→04/19 06/16→04/19 06/16→04/19 10/16→04/19 10/16→04/19 10/16→04/19 10/16→08/19					24.4156-1136.3 011126	ATE Ø 27 ohne Bremsflüssigkeitsbehälter
300 e 4-matic	235	11/19→03/23		für Linkslenker; → Modelljahr bis: 2019			24.4156-1136.3 011126	ATE Ø 27 ohne Bremsflüssigkeitsbehälter
				für Linkslenker			24.4156-1221.3 011127	ATE Ø 27 ohne Bremsflüssigkeitsbehälter
AMG 63 4-matic+ AMG 63 S 4-matic+	350 375	06/17→03/23 06/17→03/23		für Linkslenker; +SA 806/807			24.4156-1136.3 011126	ATE Ø 27 ohne Bremsflüssigkeitsbehälter
MERCEDES-BENZ - GLK-KLASSE (X204) 06/08→12/15								
 Bremskraftverstärker								
200 200 CDI	135 100 - 105	08/13→06/15 07/10→06/15		für Linkslenker; für Fahrzeuge ohne Start-Stopp-Funktion			03.7745-6302.4 300261	ATE Ø 8" pneumatisch
250 250 4-matic 250 CDI 4-matic 300 4-matic	155 155 150 170 - 185	08/13→06/15 08/13→06/15 09/09→06/15 07/09→12/15		für Linkslenker; für Fahrzeuge mit Start-Stopp-Funktion			03.7745-8902.4 300297	ATE Ø 8" pneumatisch
350 350 CDI 4-matic	200 165 - 195	04/09→06/15 07/09→06/15						
220 CDI 220 CDI 4-matic	120 - 125 120 - 125	12/08→06/15 12/08→06/15		04/09→; für Linkslenker; für Fahrzeuge ohne Start-Stopp-Funktion			03.7745-6302.4 300261	ATE Ø 8" pneumatisch
				04/09→; für Linkslenker; für Fahrzeuge mit Start-Stopp-Funktion			03.7745-8902.4 300297	ATE Ø 8" pneumatisch
280 4-matic 320 CDI 4-matic 350 4-matic	170 165 200 - 225	06/08→06/09 06/08→06/15 06/08→06/15		09/08→; für Linkslenker; für Fahrzeuge ohne Start-Stopp-Funktion			03.7745-6302.4 300261	ATE Ø 8" pneumatisch
				09/08→; für Linkslenker; für Fahrzeuge mit Start-Stopp-Funktion			03.7745-8902.4 300297	ATE Ø 8" pneumatisch
→								



























	kW					! #		
MERCEDES-BENZ - GLK-KLASSE (X204) 06/08→12/15								
 Hauptbremszylinder								
200 200 CDI	135 100 - 105	08/13→06/15 07/10→06/15		für Linkslenker			03.2025-2521.3 010959	ATE Ø1 25,4 Ø2 22,2
250 250 4-matic 250 CDI 4-matic 300 4-matic	155 155 150 170 - 185	08/13→06/15 08/13→06/15 09/09→06/15 07/09→12/15						
350 350 CDI 4-matic	200 165 - 195	04/09→06/15 07/09→06/15						
220 CDI 220 CDI 4-matic	120 - 125 120 - 125	12/08→06/15 12/08→06/15		04/09→; für Linkslenker			03.2025-2521.3 010959	ATE Ø1 25,4 Ø2 22,2
280 4-matic 320 CDI 4-matic 350 4-matic	170 165 200 - 225	06/08→06/09 06/08→06/15 06/08→06/15		09/08→; für Linkslenker			03.2025-2521.3 010959	ATE Ø1 25,4 Ø2 22,2
MERCEDES-BENZ - GL-KLASSE (X164) 09/06→12/12								
Pedalwegsensor, Bremspedal								
GL 320 CDI / 350 BlueTEC 4-matic GL 350 CDI 4-matic	155 165 - 195	12/09→08/12 05/09→08/12		→ 06/12			03.0655-0007.2 370007	ATE
GL 450 4-matic GL 450 CDI 4-matic GL 500 4-matic	250 225 285	09/06→08/12 05/09→08/12 09/06→12/12						
GL 320 CDI 4-matic GL 420 CDI 4-matic	160 - 165 225	09/06→12/09 09/06→05/09					03.0655-0007.2 370007	ATE
 Hauptbremszylinder								
GL 320 CDI / 350 BlueTEC 4-matic GL 350 CDI 4-matic	155 165 - 195	12/09→08/12 05/09→08/12		→ 06/12			03.4156-0014.3 010930	ATE Ø 27 ohne Bremsflüssigkeitsbehälter
GL 450 4-matic GL 450 CDI 4-matic GL 500 4-matic	250 225 285	09/06→08/12 05/09→08/12 09/06→12/12						
GL 320 CDI 4-matic GL 420 CDI 4-matic	160 - 165 225	09/06→12/09 09/06→05/09					03.4156-0014.3 010930	ATE Ø 27 ohne Bremsflüssigkeitsbehälter
MERCEDES-BENZ - M-KLASSE (W163) 02/98→07/05								
Pedalwegsensor, Bremspedal								
ML 270 CDI ML 350 ML 400 CDI ML 500 ML 55 AMG	120 173 184 215 255	12/99→06/05 02/03→06/05 09/01→06/05 09/01→06/05 02/00→06/05					03.0655-0007.2 370007	ATE
ML 320 ML 350 ML 430	160 180 200	02/98→08/02 08/02→06/05 02/98→06/05		03/98→; + ESP 09/02→ 09/98→			03.0655-0007.2 370007	ATE ATE ATE
 Hauptbremszylinder								
ML 230 ML 320	110 160	02/98→06/05 02/98→08/02		03/98→			03.2125-7310.3 010743	ATE Ø 25,4
ML 270 CDI ML 350 ML 400 CDI ML 500 ML 55 AMG	120 173 184 215 255	12/99→06/05 02/03→06/05 09/01→06/05 09/01→06/05 02/00→06/05					03.2125-7310.3 010743	ATE Ø 25,4
ML 350 ML 430	180 200	08/02→06/05 02/98→06/05		09/02→ 09/98→			03.2125-7310.3 010743	ATE Ø 25,4 ATE Ø 25,4
MERCEDES-BENZ - M-KLASSE (W164) 02/05→12/12								
Pedalwegsensor, Bremspedal								
ML 280 CDI 4-matic ML 320 CDI 4-matic	140 155 - 165	07/05→07/09 07/05→07/11					03.0655-0007.2 370007	ATE
ML 350 CDI 4-matic ML 63 AMG 4-matic	157 375	09/09→12/10 09/06→12/11						
ML 300 4-matic ML 300 CDI 4-matic	170 140 - 150	03/10→12/11 07/09→12/11		→ 05/11			03.0655-0007.2 370007	ATE











	kW			 	! #		
MERCEDES-BENZ - M-KLASSE (W164) 02/05→12/12							
Pedalwegsensoren, Bremspedal							
ML 350 4-matic	200	02/05→12/11		→ 05/11		03.0655-0007.2 370007	ATE
ML 350 CDI 4-matic	155 - 170	07/09→12/11					
ML 450 CDI 4-matic	225	09/09→12/11					
ML 500 4-matic	225 - 285	07/05→12/11					
ML 63 AMG 4-matic	375	01/06→12/11					
ML 420 CDI 4-matic	225	02/06→09/09		04/06→		03.0655-0007.2 370007	ATE
 Hauptbremszylinder							
ML 280 CDI 4-matic	140	07/05→07/09				03.4156-0014.3 010930	ATE Ø 27 ohne Bremsflüssigkeitsbehälter
ML 320 CDI 4-matic	155 - 165	07/05→07/11					
ML 350 CDI 4-matic	157	09/09→12/10					
ML 63 AMG 4-matic	375	09/06→12/11					
ML 300 4-matic	170	03/10→12/11		→ 05/11		03.4156-0014.3 010930	ATE Ø 27 ohne Bremsflüssigkeitsbehälter
ML 300 CDI 4-matic	140 - 150	07/09→12/11					
ML 350 4-matic	200	02/05→12/11					
ML 350 CDI 4-matic	155 - 170	07/09→12/11					
ML 450 CDI 4-matic	225	09/09→12/11					
ML 500 4-matic	225 - 285	07/05→12/11					
ML 63 AMG 4-matic	375	01/06→12/11					
ML 420 CDI 4-matic	225	02/06→09/09		04/06→		03.4156-0014.3 010930	ATE Ø 27 ohne Bremsflüssigkeitsbehälter
MERCEDES-BENZ - R-KLASSE (W251, V251) 08/05→10/17							
Pedalwegsensoren, Bremspedal							
R 280	170	01/07→12/14				03.0655-0007.2 370007	ATE
R 280 CDI	140	05/06→12/12					
R 280 CDI 4-matic	140	05/06→12/12					
R 300	170	07/09→12/14					
R 300 CDI	140	07/09→12/12					
R 300 CDI 4-matic	140	07/09→12/12					
R 320 CDI 4-matic	155 - 165	01/06→12/12					
R 350	200	01/07→12/12					
R 350 4-matic	200	08/05→12/12					
R 350 CDI 4-matic	165 - 195	07/09→12/14					
R 350 CGI 4-matic	225	10/11→12/14					
R 500 4-matic	225 - 285	08/05→12/14					
R 63 AMG 4-matic	375	02/06→12/10					
R 350 CDI 4-matic	155	01/06→12/14		05/09→		03.0655-0007.2 370007	ATE
 Hauptbremszylinder							
R 280	170	01/07→12/14				03.4156-0014.3 010930	ATE Ø 27 ohne Bremsflüssigkeitsbehälter
R 280 CDI	140	05/06→12/12					
R 280 CDI 4-matic	140	05/06→12/12					
R 300	170	07/09→12/14					
R 300 CDI	140	07/09→12/12					
R 300 CDI 4-matic	140	07/09→12/12					
R 320 CDI 4-matic	155 - 165	01/06→12/12					
R 350	200	01/07→12/12					
R 350 4-matic	200	08/05→12/12					
R 350 CDI 4-matic	165 - 195	07/09→12/14					
R 350 CGI 4-matic	225	10/11→12/14					
R 500 4-matic	225 - 285	08/05→12/14					
R 63 AMG 4-matic	375	02/06→12/10					
R 350 CDI 4-matic	155	01/06→12/14		05/09→		03.4156-0014.3 010930	ATE Ø 27 ohne Bremsflüssigkeitsbehälter
MERCEDES-BENZ - S-KLASSE (W220) 09/98→08/05							
 Hauptbremszylinder							
S 280	150	10/98→08/05		11/98→		24.4025-1701.3 010719	Ø 25,4
S 320	165	10/98→08/05					
S 430	205	10/98→08/05					
S 500	220 - 225	10/98→08/05					
S 320 CDI	145 - 150	08/99→08/05				24.4025-1701.3 010719	Ø 25,4
S 350	180	09/02→08/05					
S 350 4-matic	180	06/03→08/05					
→							













	kw					! #		
MERCEDES-BENZ - S-KLASSE (W220) 09/98→08/05								
 Hauptbremszylinder								
S 400 CDI	191	06/03→08/05					24.4025-1701.3 010719	Ø 25,4
S 430 4-matic	205	09/02→08/05						
S 500 4-matic	225	09/02→08/05						
S 55 AMG	265	04/99→08/05						
S 55 AMG Kompressor	368	06/02→08/05						
S 600	270 - 368	01/00→08/05						
S 63 AMG	326	09/01→08/05						
S 65 AMG	450	03/04→08/05						
S 400 CDI	184	06/00→08/05		08/00→			24.4025-1701.3 010719	Ø 25,4
MERCEDES-BENZ - S-KLASSE (W221) 09/05→12/13								
 Bremskraftverstärker								
S 280	170	08/06→12/13		→ A 265574			03.7858-1932.4 300263	ATE Ø 9 / 8" pneumatisch
S 300	170	08/06→12/13						
S 320 CDI	173	12/05→06/09						
S 320 CDI 4-matic	155 - 173	10/05→12/13						
S 350 4-matic	200	02/08→12/13						
S 350 CDI	155 - 173	06/09→12/13						
S 350 CDI 4-matic	155 - 173	01/09→07/13						
S 420 CDI	235	10/06→12/09						
S 450 CDI	235	01/09→12/13						
S 63 AMG	400 - 420	03/11→12/13						
S 320 CDI	155	10/05→12/13		12/05→; → A 265574			03.7858-1932.4 300263	ATE Ø 9 / 8" pneumatisch
S 350	200	10/05→12/13						
S 500	285	10/05→12/13						
S 450	250	12/05→12/13		04/06→; → A 265574			03.7858-1932.4 300263	ATE Ø 9 / 8" pneumatisch
S 450 4-matic	250	12/05→12/13						
S 500 4-matic	285	10/05→12/13						
S 63 AMG	386	10/06→12/13		01/07→; → A 265574			03.7858-1932.4 300263	ATE Ø 9 / 8" pneumatisch
Pedalwegsensoren, Bremspedal								
S 250 CDI	150	01/11→12/13		→ 05/13; für Fahrzeuge mit autom. Distanzregelung			03.0655-0007.2 370007	ATE
S 350 BlueTec	190	04/11→12/13						
S 350 BlueTEC 4-matic	190	04/11→12/13						
S 350 CGI	225	04/11→12/13						
S 350 CGI 4-matic	225	04/11→12/13						
S 500 CGI	320	04/11→12/13						
S 500 CGI 4-matic	320	03/11→12/13						
S 550	320	09/11→12/13						
S 280	170	08/06→12/13		→ A 265574			03.0655-0007.2 370007	ATE
S 300	170	08/06→12/13						
S 320 CDI 4-matic	173	10/06→12/13		A 265575→; → 05/13; für Fahrzeuge mit autom. Distanzregelung			03.0655-0007.2 370007	ATE
S 350 4-matic	200	02/08→12/13						
S 350 CDI	155 - 173	06/09→12/13						
S 320 CDI	155	10/05→12/13		12/05→; → A 265574			03.0655-0007.2 370007	ATE
S 350	200	10/05→12/13						
S 500	285	10/05→12/13		A 265575→; → 05/13; für Fahrzeuge mit autom. Distanzregelung			03.0655-0007.2 370007	ATE
S 320 CDI	173	12/05→06/09		→ A 265574			03.0655-0007.2 370007	ATE
S 320 CDI 4-matic	155	10/05→12/13						
S 350 CDI 4-matic	155 - 173	01/09→07/13		A 265575→; für Fahrzeuge mit autom. Distanzregelung			03.0655-0007.2 370007	ATE
S 420 CDI	235	10/06→12/09						
S 450 CDI	235	01/09→12/13						
S 400 Hybrid	220	09/09→12/13					03.0655-0007.2 370007	ATE
S 400 Hybrid	205	01/09→12/13		06/09→ 05/13			03.0655-0007.2 370007	ATE
S 450	250	12/05→12/13		04/06→; → A 265574			03.0655-0007.2 370007	ATE
S 450 4-matic	250	12/05→12/13						
S 500 4-matic	285	10/05→12/13		A 265575→; → 05/13; für Fahrzeuge mit autom. Distanzregelung			03.0655-0007.2 370007	ATE
S 600	380	12/05→12/13		für Fahrzeuge ohne Start-Stopp-Funktion; → 05/13			03.0655-0007.2 370007	ATE
				A 060621→; für Fahrzeuge ohne Start-Stopp-Funktion; → 05/13			03.0655-0007.2 370007	ATE
				→ A 060620; für Fahrzeuge ohne Start-Stopp-Funktion			03.0655-0007.2 370007	ATE
S 63 AMG	400 - 420	03/11→12/13		→ A 265574			03.0655-0007.2 370007	ATE
				A 265575→; → 05/13; für Fahrzeuge mit autom. Distanzregelung			03.0655-0007.2 370007	ATE
				→ 05/13			03.0655-0007.2 370007	ATE
S 63 AMG	386	10/06→12/13		01/07→; → A 265574			03.0655-0007.2 370007	ATE
→								













	kw					! #		
MERCEDES-BENZ - S-KLASSE (W221) 09/05→12/13								
Pedalwegsensord, Bremspedal								
S 63 AMG	386	10/06→12/13		A 265575→; → 05/13; für Fahrzeuge mit autom. Distanzregelung			03.0655-0007.2 370007	ATE
				01/07→ 05/13			03.0655-0007.2 370007	ATE
S 65 AMG	450	12/05→12/13		A 060621→; → 05/13			03.0655-0007.2 370007	ATE
				04/06→; → A 060620			03.0655-0007.2 370007	ATE
				04/06→ 05/13			03.0655-0007.2 370007	ATE
S 65 AMG	463	10/10→12/13		→ A 060620			03.0655-0007.2 370007	ATE
				A 060621→; → 05/13			03.0655-0007.2 370007	ATE
				→ 05/13			03.0655-0007.2 370007	ATE
 Hauptbremszylinder								
S 250 CDI	150	01/11→12/13		→ 05/13			03.4156-0073.3 010942	ATE Ø 27
S 350 BlueTec	190	04/11→12/13						
S 350 BlueTEC 4-matic	190	04/11→12/13						
S 350 CGI	225	04/11→12/13						
S 350 CGI 4-matic	225	04/11→12/13						
S 500 CGI	320	04/11→12/13						
S 500 CGI 4-matic	320	03/11→12/13						
S 550	320	09/11→12/13						
S 280	170	08/06→12/13		→ A 293047; nicht für gepanzerte Fahrzeuge			03.4055-0013.3 010793	ATE Ø 25,4
S 300	170	08/06→12/13						
S 320 CDI 4-matic	173	10/06→12/13		A 293048→; → 05/13; nicht für gepanzerte Fahrzeuge			03.4156-0073.3 010942	ATE Ø 27
S 350 4-matic	200	02/08→12/13						
S 350 CDI	155 - 173	06/09→12/13						
S 600	380	12/05→12/13						
S 63 AMG	400 - 420	03/11→12/13						
S 65 AMG	463	10/10→12/13						
S 320 CDI	155	10/05→12/13		12/05→; → A 293047; nicht für gepanzerte Fahrzeuge			03.4055-0013.3 010793	ATE Ø 25,4
S 350	200	10/05→12/13						
S 500	285	10/05→12/13		A 293048→; → 05/13; nicht für gepanzerte Fahrzeuge			03.4156-0073.3 010942	ATE Ø 27
S 320 CDI	173	12/05→06/09		→ A 293047; nicht für gepanzerte Fahrzeuge			03.4055-0013.3 010793	ATE Ø 25,4
S 320 CDI 4-matic	155	10/05→12/13						
S 350 CDI 4-matic	155 - 173	01/09→07/13		A 293048→; nicht für gepanzerte Fahrzeuge			03.4156-0073.3 010942	ATE Ø 27
S 420 CDI	235	10/06→12/09						
S 450 CDI	235	01/09→12/13						
S 400 Hybrid	220	09/09→12/13					03.4155-5141.3 010969	ATE Ø 25,4
S 400 Hybrid	205	01/09→12/13		06/09→ 05/13			03.4155-5141.3 010969	ATE Ø 25,4
S 450	250	12/05→12/13		04/06→; → A 293047; nicht für gepanzerte Fahrzeuge			03.4055-0013.3 010793	ATE Ø 25,4
S 450 4-matic	250	12/05→12/13						
S 500 4-matic	285	10/05→12/13		A 293048→; → 05/13; nicht für gepanzerte Fahrzeuge			03.4156-0073.3 010942	ATE Ø 27
S 65 AMG	450	12/05→12/13						
S 63 AMG	386	10/06→12/13		01/07→; → A 293047; nicht für gepanzerte Fahrzeuge			03.4055-0013.3 010793	ATE Ø 25,4
				A 293048→; → 05/13; nicht für gepanzerte Fahrzeuge			03.4156-0073.3 010942	ATE Ø 27
MERCEDES-BENZ - S-KLASSE Coupe (C215) 03/99→12/06								
 Hauptbremszylinder								
CL 500	225	03/99→03/06					24.4025-1701.3 010719	Ø 25,4
CL 55 AMG	265	10/99→03/06						
CL 55 AMG Kompressor	368	06/02→03/06						
CL 600	270 - 368	03/99→03/06						
CL 65 AMG	450	09/03→03/06						
MERCEDES-BENZ - S-KLASSE Coupe (C216) 05/06→12/13								
 Bremskraftverstärker								
CL 500	285	06/06→12/13		07/06→; → A 024306			03.7858-1932.4 300263	ATE Ø 9 / 8" pneumatisch
CL 600	380	05/06→12/13						
CL 500	320	02/11→12/13		→ A 024306			03.7858-1932.4 300263	ATE Ø 9 / 8" pneumatisch
CL 500 4-matic	320	02/11→12/13						
CL 63 AMG	386 - 420	09/07→12/13						
CL 65 AMG	463	02/11→12/13						
CL 500 4-matic	285	02/08→12/13		03/08→; → A 024306			03.7858-1932.4 300263	ATE Ø 9 / 8" pneumatisch
CL 63 AMG	386	10/06→12/13		01/07→; → A 024306			03.7858-1932.4 300263	ATE Ø 9 / 8" pneumatisch
CL 65 AMG	450	10/06→12/10						
Pedalwegsensord, Bremspedal								
CL 500	285	06/06→12/13		A 024307→			03.0655-0007.2 370007	ATE
→								















	kw				! #		
MERCEDES-BENZ - S-KLASSE Coupe (C216) 05/06→12/13							
Pedalwegsensoren, Bremspedal							
CL 600	380	05/06→12/13		07/06→; → A 024306		03.0655-0007.2 370007	ATE
CL 500	320	02/11→12/13		A 024307→		03.0655-0007.2 370007	ATE
CL 500 4-matic	320	02/11→12/13		→ A 024306		03.0655-0007.2 370007	ATE
CL 63 AMG	386 - 420	09/07→12/13					
CL 65 AMG	463	02/11→12/13					
CL 500 4-matic	285	02/08→12/13		A 024307→		03.0655-0007.2 370007	ATE
				03/08→; → A 024306		03.0655-0007.2 370007	ATE
CL 63 AMG	386	10/06→12/13		A 024307→		03.0655-0007.2 370007	ATE
CL 65 AMG	450	10/06→12/10		01/07→; → A 024306		03.0655-0007.2 370007	ATE
 Hauptbremszylinder							
CL 500	285	06/06→12/13		07/06→; → A 024016		03.4055-0013.3 010793	ATE Ø 25,4
CL 600	380	05/06→12/13		A 024017→		03.4156-0073.3 010942	ATE Ø 27
CL 500	320	02/11→12/13				03.4156-0073.3 010942	ATE Ø 27
CL 500 4-matic	320	02/11→12/13					
CL 63 AMG	400 - 420	01/10→12/13					
CL 500 4-matic	285	02/08→12/13		03/08→; → A 024016		03.4055-0013.3 010793	ATE Ø 25,4
				A 024017→		03.4156-0073.3 010942	ATE Ø 27
CL 63 AMG	386	10/06→12/13		01/07→; → A 024016		03.4055-0013.3 010793	ATE Ø 25,4
CL 65 AMG	450	10/06→12/10		A 024017→		03.4156-0073.3 010942	ATE Ø 27
CL 63 AMG	386	09/07→12/11		→ A 024016		03.4055-0013.3 010793	ATE Ø 25,4
CL 65 AMG	463	02/11→12/13		A 024017→		03.4156-0073.3 010942	ATE Ø 27
MERCEDES-BENZ - SL (R129) 03/89→09/04							
 Hauptbremszylinder							
280	142	08/93→10/01		→ F102744; für Linkslenker		03.2025-0211.3 010034	Ø1 25,4 Ø2 19
320	170	09/93→10/01		F102745→ F148143; für Linkslenker		24.2025-1702.3 010515	Ø1 25,4 Ø2 19
500	235	09/92→10/01		08/93→; → F102744; - ESP; für Linkslenker		03.2025-0211.3 010034	Ø1 25,4 Ø2 19
				F102745→ F148143; - ESP; für Linkslenker		24.2025-1702.3 010515	Ø1 25,4 Ø2 19
60 AMG	280	05/97→10/01		→ F102744; - ESP; für Linkslenker		03.2025-0211.3 010034	Ø1 25,4 Ø2 19
				F102745→ F148143; - ESP; für Linkslenker		24.2025-1702.3 010515	Ø1 25,4 Ø2 19
MERCEDES-BENZ - SL (R230) 10/01→01/12							
 Bremskraftverstärker							
65 AMG Black Series	493	07/08→01/12		→ 11/11; für Linkslenker		03.7848-2002.4 300166	ATE Ø 7 / 8" pneumatisch
Pedalwegsensoren, Bremspedal							
65 AMG Black Series	493	07/08→01/12		→ 11/11; für Linkslenker		03.0655-0007.2 370007	ATE
MERCEDES-BENZ - SL (R231) 12/11→04/20							
 Hauptbremszylinder							
350	225	02/12→04/14		03/12→		03.2126-3196.3 010968	ATE Ø 27
500	320	01/12→04/20					
63 AMG	395 - 415	01/12→05/19					
400	245 - 270	04/14→04/20				03.2126-3196.3 010968	ATE Ø 27
500	335	04/15→04/20					
63 AMG	420 - 430	04/14→05/19					
65 AMG	463	05/12→06/18					
MERCEDES-BENZ - SLC (R172) 01/16→							
 Bremskraftverstärker							
180	115	01/16→		für Linkslenker; für Fahrzeuge ohne Start-Stopp-Funktion		03.7745-1632.4 300293	ATE Ø 8 / 7" pneumatisch
200	135	01/16→					
250 d	150	01/16→10/17		für Linkslenker; für Fahrzeuge mit Start-Stopp-Funktion		03.7745-1832.4 300294	ATE Ø 8 / 7" pneumatisch
300	180	01/16→					
AMG SLC 43	270 - 287	01/16→					
MERCEDES-BENZ - SLK (R170) 04/96→04/04							
Pedalwegsensoren, Bremspedal							
200 Kompressor →	120	03/00→04/04		→ 03/04		03.0655-0007.2 370007	ATE













	kw			 	! #		
MERCEDES-BENZ - SLK (R170) 04/96→04/04							
Pedalwegsensord, Bremspedal							
230 Kompressor	145	03/00→04/04		→ 03/04		03.0655-0007.2 370007	ATE
32 AMG Kompressor	260	03/01→04/04					
320	160	03/00→04/04		04/00→ 03/04		03.0655-0007.2 370007	ATE
 Hauptbremszylinder							
200	100	09/96→03/00		→ F025730		24.2023-1701.3 010514	TRW Ø1 23,8 Ø2 19
200 Kompressor	141	10/96→03/00					
230 Kompressor	142	09/96→03/00		F025731→		24.2023-1702.3 010534	TRW Ø1 23,8 Ø2 19
200 Kompressor	120	03/00→04/04		→ 03/04; für Rechtslenker		03.2025-1741.3 010705	ATE Ø1 25,4 Ø2 20,6
230 Kompressor	145	03/00→04/04					
32 AMG Kompressor	260	03/01→04/04					
320	160	03/00→04/04		04/00→ 03/04; für Rechtslenker		03.2025-1741.3 010705	ATE Ø1 25,4 Ø2 20,6
MERCEDES-BENZ - SLK (R171) 03/04→12/11							
Pedalwegsensord, Bremspedal							
200 Kompressor	120 - 135	03/04→02/11		→ F 196638		03.0655-0007.2 370007	ATE
300	170	04/09→02/11		F 196639→; → 01/11		03.0655-0007.2 370007	ATE
350	200 - 224	06/04→02/11					
55 AMG	265 - 294	06/04→02/11					
280	170	01/05→02/11		F 196639→; → 01/11		03.0655-0007.2 370007	ATE
				04/05→; → F 196638		03.0655-0007.2 370007	ATE
 Hauptbremszylinder							
200 Kompressor	120 - 135	03/04→02/11		→ 01/11; für Linkslenker		03.2025-1741.3 010705	ATE Ø1 25,4 Ø2 20,6
300	170	04/09→02/11					
350	200 - 224	06/04→02/11					
55 AMG	265 - 294	06/04→02/11					
280	170	01/05→02/11		04/05→ 01/11; für Linkslenker		03.2025-1741.3 010705	ATE Ø1 25,4 Ø2 20,6
MERCEDES-BENZ - SLK (R172) 01/11→							
 Bremskraftverstärker							
200	135	02/11→		für Linkslenker; für Fahrzeuge ohne Start-Stopp-Funktion		03.7745-1632.4 300293	ATE Ø 8 / 7" pneumatisch
250	150	02/11→					
250 CDI / d	150	01/12→		für Linkslenker; für Fahrzeuge mit Start-Stopp-Funktion		03.7745-1832.4 300294	ATE Ø 8 / 7" pneumatisch
300	180	07/15→					
350	225	02/11→					
55 AMG	310	01/12→					
MERCEDES-BENZ - SPRINTER 2-t Bus (B901, B902) 01/95→05/06							
 Hauptbremszylinder							
208 CDI	60	04/00→05/06		→ A906425		24.2123-1711.3 010518	Ø 23,8
208 D	58	02/95→04/00					
210 D	75	03/97→04/00		A906426→		24.2123-1754.3 010741	Ø 23,8
211 CDI	80	04/00→05/06					
212 D	90	02/95→04/00					
213 CDI	95	04/00→05/06					
214	105	02/95→05/06					
214 NGT	95	02/95→05/06					
216 CDI	115	04/00→05/06					
MERCEDES-BENZ - SPRINTER 2-t Kasten (B901, B902) 01/95→05/06							
 Hauptbremszylinder							
208 CDI	60	04/00→05/06		→ A906425		24.2123-1711.3 010518	Ø 23,8
208 D	58 - 60	02/95→04/00		A906426→		24.2123-1754.3 010741	Ø 23,8
210 D	75	01/97→04/00					
211 CDI	80	04/00→05/06					
212 D	90	02/95→04/00					
213 CDI	95	04/00→05/06					
214	105	02/95→05/06					
214 NGT	95	02/95→05/06					
216 CDI	115	04/00→05/06					
MERCEDES-BENZ - SPRINTER 2-t Pritsche/Fahrgestell (B901, B902) 01/95→05/06							
 Hauptbremszylinder							
208 CDI	60	04/00→05/06		→ A906425		24.2123-1711.3 010518	Ø 23,8
208 D	60	09/96→04/00					
210 D	75	01/97→04/00		A906426→		24.2123-1754.3 010741	Ø 23,8
211 CDI	80	04/00→05/06					
→							

	kW					! #		
MERCEDES-BENZ - SPRINTER 2-t Pritsche/Fahrgestell (B901, B902) 01/95→05/06								
 Hauptbremszylinder								
212 D	90	02/95→04/00		→ A906425			24.2123-1711.3 010518	Ø 23,8
213 CDI	95	04/00→05/06						
214	105	02/95→05/06		A906426→			24.2123-1754.3 010741	Ø 23,8
214 NGT	95	02/95→05/06						
216 CDI	115	04/00→05/06						
208 D	58	01/95→04/00		02/95→; → A906425			24.2123-1711.3 010518	Ø 23,8
				A906426→			24.2123-1754.3 010741	Ø 23,8
MERCEDES-BENZ - SPRINTER 3,5-t Bus (B906) 06/06→09/20								
 Hauptbremszylinder								
309 CDI	65	04/12→12/19					24.2126-1704.3 010990	TRW Ø 27
311 CDI	84	05/16→12/18					24.2126-1708.3 011128	Ø 27 ohne Bremsflüssigkeitsbehälter
313 CDI	95	08/11→12/16						
313 CDI 4x4	95	08/11→12/16						
314 CDI	105	05/16→12/18						
314 CDI 4x4	105	05/16→12/18						
315 CDI	110	06/13→09/20						
316 CDI	120	08/11→12/18						
316 CDI 4x4	120	08/11→12/18						
310 CDI	70	03/09→12/13		→ 09/09			24.2125-1750.3 011050	Ø 25,4 ohne Bremsflüssigkeitsbehälter
311 CDI	80	06/06→12/09						
311 CDI 4x4	80	02/08→12/09						
315 CDI	110	06/06→12/09		10/09→			24.2126-1704.3 010990	TRW Ø 27
315 CDI 4x4	110	02/08→12/09					24.2126-1708.3 011128	Ø 27 ohne Bremsflüssigkeitsbehälter
316	115	09/08→12/18						
316 LGT	115	09/08→12/18						
316 NGT	115	03/09→12/18						
318 CDI	135	02/08→12/09						
318 CDI 4x4	135	02/08→12/09						
319 CDI / BlueTEC	140	03/09→12/18						
319 CDI / BlueTEC 4x4	140	03/09→12/18						
324	190	06/06→12/16						
MERCEDES-BENZ - SPRINTER 3,5-t Kasten (B906) 06/06→09/20								
 Hauptbremszylinder								
309 CDI	65	06/06→12/09		→ 09/09			24.2125-1750.3 011050	Ø 25,4 ohne Bremsflüssigkeitsbehälter
310 CDI	70	03/09→12/16						
311 CDI	80	06/06→12/09		10/09→			24.2126-1704.3 010990	TRW Ø 27
311 CDI 4x4	80	02/08→12/09					24.2126-1708.3 011128	Ø 27 ohne Bremsflüssigkeitsbehälter
313 CDI	95	06/06→12/16						
313 CDI 4x4	95	03/09→12/16						
315 CDI	110	06/06→12/09						
315 CDI 4x4	110	02/08→12/09						
316	115	09/08→12/18						
316 CDI	120	03/09→12/18						
316 CDI 4x4	120	03/09→12/18						
316 NGT	115	09/08→12/18						
318 CDI	135	06/06→12/09						
318 CDI 4x4	135	02/08→12/09						
319 CDI / BlueTEC	140	03/09→12/18						
319 CDI / BlueTEC 4x4	140	03/09→12/18						
324	190	06/06→12/16						
311 CDI	84	05/16→12/18					24.2126-1704.3 010990	TRW Ø 27
314 CDI	105	05/16→12/18					24.2126-1708.3 011128	Ø 27 ohne Bremsflüssigkeitsbehälter
314 CDI 4x4	105	05/16→12/18						
315 CDI	110	12/14→09/20						
316 LGT	115	01/11→12/18						
MERCEDES-BENZ - SPRINTER 3,5-t Kasten (B907, B910) 02/18→								
 Hauptbremszylinder								
311 CDI	84	02/18→					24.2126-1708.3 011128	Ø 27 ohne Bremsflüssigkeitsbehälter
311 CDI RWD	84	02/18→						
314 CDI	105	02/18→						
314 CDI All-wheel Drive	105	01/19→						
314 CDI RWD	105	02/18→						
315 CDI	110	10/21→						
315 CDI RWD	110	06/20→						
316 CDI All-wheel Drive	120	01/19→						
316 CDI RWD	120	02/18→						
317 CDI	125	03/22→						
317 CDI RWD	125	06/20→						
319 CDI All-wheel Drive	140	01/19→						
319 CDI RWD	140	02/18→						











	kw			 	! #		
MERCEDES-BENZ - SPRINTER 3,5-t Pritsche/Fahrgestell (B906) 06/06→12/18							
 Hauptbremszylinder							
309 CDI	65	06/06→12/09		→ 09/09		24.2125-1750.3 011050	Ø 25,4 ohne Bremsflüssigkeitsbehälter
310 CDI	70	03/09→12/16					
311 CDI	80	06/06→12/09					
311 CDI 4x4	80	02/08→12/09		10/09→		24.2126-1704.3 010990	TRW Ø 27
313 CDI	95	06/06→12/16				24.2126-1708.3 011128	Ø 27 ohne Bremsflüssigkeitsbehälter
313 CDI 4x4	95	06/06→12/16					
315 CDI	110	06/06→12/09					
315 CDI 4x4	110	02/08→12/09					
316	115	09/08→12/18					
316 CDI	120	03/09→12/18					
316 CDI 4x4	120	03/09→12/18					
316 NGT	115	09/08→12/18					
318 CDI	135	06/06→12/09					
318 CDI 4x4	135	02/08→12/09					
319 CDI / BlueTEC	140	03/09→12/18					
324	190	06/06→12/16					
311 CDI	84	05/16→12/18				24.2126-1704.3 010990	TRW Ø 27
314 CDI	105	04/16→12/18				24.2126-1708.3 011128	Ø 27 ohne Bremsflüssigkeitsbehälter
314 CDI 4x4	105	05/16→12/18					
316 LGT	115	01/11→12/18					
319 CDI / BlueTEC 4x4	140	03/09→12/18					
MERCEDES-BENZ - SPRINTER 3,5-t Pritsche/Fahrgestell (B907, B910) 02/18→							
 Hauptbremszylinder							
311 CDI	84	02/18→				24.2126-1708.3 011128	Ø 27 ohne Bremsflüssigkeitsbehälter
311 CDI RWD	84	02/18→					
314 CDI	105	02/18→					
314 CDI All-wheel Drive	105	01/19→					
314 CDI RWD	105	02/18→					
315 CDI	110	06/20→					
315 CDI RWD	110	06/20→					
316 CDI All-wheel Drive	120	01/19→					
316 CDI RWD	120	02/18→					
317 CDI	125	02/18→					
317 CDI RWD	125	06/20→					
318 CDI	130	02/18→					
319 CDI All-wheel Drive	140	01/19→					
319 CDI RWD	140	02/18→					
MERCEDES-BENZ - SPRINTER 3,5-t Tourer Bus (B907) 02/18→							
 Hauptbremszylinder							
311 CDI	84	02/18→				24.2126-1708.3 011128	Ø 27 ohne Bremsflüssigkeitsbehälter
314 CDI	105	02/18→					
314 CDI All-wheel Drive	105	01/19→					
315 CDI	110	10/21→					
316 CDI	120	02/18→					
316 CDI All-wheel Drive	120	01/19→					
317 CDI	125	10/21→					
319 CDI	140	02/18→					
319 CDI All-wheel Drive	140	01/19→					
MERCEDES-BENZ - SPRINTER 3-t Bus (B903) 01/95→05/12							
 Hauptbremszylinder							
308 CDI	60	04/00→05/06		→ A905511 / R400726		24.2123-1711.3 010518	Ø 23,8
308 D	58 - 60	02/95→04/00		A905512 / R400727→		24.2123-1754.3 010741	Ø 23,8
310 D	75	01/97→12/99					
310 D 4x4	75	05/97→08/02					
311 CDI	80	04/00→05/06					
311 CDI 4x4	80	08/02→05/06					
312 D 2.9	90	02/95→04/00					
312 D 2.9 4x4	90	05/97→08/02					
313 CDI	95	04/00→05/06					
313 CDI 4x4	95	08/02→05/06					
314	105	02/95→05/06					
314 4x4	105	08/02→05/06					
314 NGT	95	02/95→05/06					
316 CDI	115	04/00→05/06					
316 CDI 4x4	115	08/02→05/06					
MERCEDES-BENZ - SPRINTER 3-t Bus (B906) 06/06→12/19							
 Hauptbremszylinder							
209 CDI	65	04/12→12/19				24.2126-1704.3 010990	TRW Ø 27
211 CDI	84	04/16→12/18				24.2126-1708.3 011128	Ø 27 ohne Bremsflüssigkeitsbehälter
214 CDI	105	04/16→12/18					
218 CDI	135	04/12→12/18					
210 CDI	70	03/09→12/13		→ 09/09		24.2125-1750.3 011050	Ø 25,4 ohne Bremsflüssigkeitsbehälter
211 CDI	80	06/06→12/09					
→							













	kw			 	! #			
MERCEDES-BENZ - SPRINTER 3-t Bus (B906) 06/06→12/19								
 Hauptbremszylinder								
213 CDI	95	06/06→12/16		10/09→		24.2126-1704.3 010990	TRW Ø 27	
215 CDI	110	06/06→12/09				24.2126-1708.3 011128	Ø 27 ohne Bremsflüssigkeitsbehälter	
216	115	03/09→12/18						
216 CDI	120	06/09→12/18						
224	190	06/06→12/13						
MERCEDES-BENZ - SPRINTER 3-t Kasten (B903) 01/95→05/12								
 Hauptbremszylinder								
308 CDI	60	04/00→05/06		→ A905511 / R400726		24.2123-1711.3 010518	Ø 23,8	
308 D 2.3	58 - 60	02/95→04/00		A905512 / R400727→		24.2123-1754.3 010741	Ø 23,8	
310 D 2.9	75	02/95→04/00						
311 CDI	80	04/00→05/06						
311 CDI 4x4	80	08/02→05/06						
312 D 2.9	90	02/95→04/00						
312 D 2.9 4x4	90	05/97→08/02						
313 CDI	95	04/00→05/06						
313 CDI 4x4	95	08/02→05/06						
314	105	02/95→05/06						
314 4x4	105	08/02→05/06						
314 NGT	95	02/95→05/06						
316 CDI	115	04/00→05/06						
316 CDI 4x4	115	02/01→05/06						
MERCEDES-BENZ - SPRINTER 3-t Kasten (B906) 06/06→12/18								
 Hauptbremszylinder								
209 CDI	65	06/06→12/09		→ 09/09		24.2125-1750.3 011050	Ø 25,4 ohne Bremsflüssigkeitsbehälter	
210 CDI	70	03/09→12/16						
211 CDI	80	06/06→12/09		10/09→		24.2126-1704.3 010990	TRW Ø 27	
213 CDI	95	06/06→12/16				24.2126-1708.3 011128	Ø 27 ohne Bremsflüssigkeitsbehälter	
215 CDI	110	06/06→12/09						
216	115	09/08→12/18						
216 CDI	120	03/09→12/18						
218 CDI	135	06/06→12/09						
219 CDI / BlueTEC	140	03/09→12/18						
224	190	06/06→12/16						
211 CDI	84	04/16→12/18				24.2126-1704.3 010990		TRW Ø 27
214 CDI	105	04/16→12/18				24.2126-1708.3 011128		Ø 27 ohne Bremsflüssigkeitsbehälter
MERCEDES-BENZ - SPRINTER 3-t Kasten (B910) 02/18→								
 Hauptbremszylinder								
211 CDI	84	02/18→				24.2126-1708.3 011128	Ø 27 ohne Bremsflüssigkeitsbehälter	
214 CDI	105	02/18→						
215 CDI	110	10/21→						
MERCEDES-BENZ - SPRINTER 3-t Pritsche/Fahrgestell (B903) 01/95→05/12								
 Hauptbremszylinder								
308 CDI	60	04/00→05/06		→ A905511 / R400726		24.2123-1711.3 010518	Ø 23,8	
308 D 2.3	58 - 60	02/95→04/00		A905512 / R400727→		24.2123-1754.3 010741	Ø 23,8	
310 D 2.9	75	01/97→04/00						
311 CDI	80	04/00→05/06						
311 CDI 4x4	80	04/00→05/06						
312 D 2.9	85 - 90	02/95→09/01						
313 CDI	95	04/00→05/06						
313 CDI 4x4	95	04/00→05/06						
314	105	02/95→05/06						
314 4x4	105	08/02→05/06						
314 NGT	95	02/95→05/06						
316 CDI	115	04/00→05/06						
316 CDI 4x4	115	08/02→05/06						
MERCEDES-BENZ - SPRINTER 3-t Pritsche/Fahrgestell (B906) 06/06→12/18								
 Hauptbremszylinder								
209 CDI	65	06/06→12/09		→ 09/09		24.2125-1750.3 011050	Ø 25,4 ohne Bremsflüssigkeitsbehälter	
210 CDI	70	03/09→12/16						
211 CDI	80	06/06→12/09		10/09→		24.2126-1704.3 010990	TRW Ø 27	
213 CDI	95	06/06→12/16				24.2126-1708.3 011128	Ø 27 ohne Bremsflüssigkeitsbehälter	
215 CDI	110	06/06→12/09						
216	115	09/08→12/18						
216 CDI	120	03/09→12/18						
218 CDI	135	06/06→12/09						
219 CDI / BlueTEC	140	03/09→12/18						
224	190	06/06→12/16						
→								











	kw					! #		
MERCEDES-BENZ - SPRINTER 3-t Pritsche/Fahrgestell (B906) 06/06→12/18								
 Hauptbremszylinder								
211 CDI 214 CDI	84 105	04/16→12/18 04/16→12/18					24.2126-1704.3 010990 24.2126-1708.3 011128	TRW Ø 27 Ø 27 ohne Bremsflüssigkeitsbehälter
MERCEDES-BENZ - SPRINTER 3-t Pritsche/Fahrgestell (B910, B907) 02/18→								
 Hauptbremszylinder								
211 CDI 211 CDI RWD 214 CDI 214 CDI RWD 215 CDI 215 CDI RWD 216 CDI RWD 217 CDI RWD	84 84 105 105 110 110 120 125	02/18→ 02/18→ 02/18→ 02/18→ 10/21→ 06/20→ 02/18→ 06/20→					24.2126-1708.3 011128	Ø 27 ohne Bremsflüssigkeitsbehälter
MERCEDES-BENZ - SPRINTER 3-t Tourer Bus (B907) 02/18→								
 Hauptbremszylinder								
211 CDI 214 CDI 215 CDI 217 CDI	84 105 110 125	02/18→ 02/18→ 10/21→ 10/21→					24.2126-1708.3 011128	Ø 27 ohne Bremsflüssigkeitsbehälter
MERCEDES-BENZ - SPRINTER 4,6-t Kasten (B906) 06/06→09/20								
 Hauptbremszylinder								
411 CDI 413 CDI 415 CDI 416 CDI 418 CDI 419 CDI 424	80 95 110 120 135 140 190	06/09→12/18 06/06→12/16 06/09→12/09 03/09→12/18 06/09→05/16 03/09→12/18 06/06→12/16		→ 09/09 10/09→			24.2125-1750.3 011050 24.2126-1704.3 010990 24.2126-1708.3 011128	Ø 25,4 ohne Bremsflüssigkeitsbehälter TRW Ø 27 Ø 27 ohne Bremsflüssigkeitsbehälter
411 CDI 414 CDI 414 CDI 4x4	84 105 105	04/16→12/18 05/16→12/18 05/16→12/18					24.2126-1704.3 010990 24.2126-1708.3 011128	TRW Ø 27 Ø 27 ohne Bremsflüssigkeitsbehälter
416 CDI 4x4	120	11/13→12/18					24.2125-1750.3 011050 24.2126-1704.3 010990 24.2126-1708.3 011128	Ø 25,4 ohne Bremsflüssigkeitsbehälter TRW Ø 27 Ø 27 ohne Bremsflüssigkeitsbehälter
MERCEDES-BENZ - SPRINTER 4,6-t Pritsche/Fahrgestell (B906) 06/06→09/20								
 Hauptbremszylinder								
411 CDI 413 CDI 415 CDI 416 CDI 418 CDI 419 CDI 424	80 95 110 120 135 140 190	06/09→12/18 06/06→12/16 06/06→12/09 03/09→12/18 06/06→12/09 03/09→12/18 06/06→12/16		→ 09/09 10/09→			24.2125-1750.3 011050 24.2126-1704.3 010990 24.2126-1708.3 011128	Ø 25,4 ohne Bremsflüssigkeitsbehälter TRW Ø 27 Ø 27 ohne Bremsflüssigkeitsbehälter
411 CDI 414 CDI 415 CDI	84 105 110	04/16→12/18 05/16→12/18 01/12→09/20					24.2126-1704.3 010990 24.2126-1708.3 011128	TRW Ø 27 Ø 27 ohne Bremsflüssigkeitsbehälter
MERCEDES-BENZ - SPRINTER 4-t Bus (B904) 02/96→05/06								
 Hauptbremszylinder								
408 CDI 411 CDI 413 CDI 414 416 CDI	60 80 95 105 115	04/00→05/06 04/00→05/06 04/00→05/06 02/96→05/06 04/00→05/06		→ A906425 / R400726 A906426 / R400727→			24.2125-1727.3 010723 24.2125-1728.3 010751	Ø 25,4 Ø 25,4
MERCEDES-BENZ - SPRINTER 4-t Kasten (B904) 02/95→05/12								
 Hauptbremszylinder								
408 CDI 408 D 410 D 4x4 411 CDI 411 CDI 4x4 412 D 412 D 4x4 413 CDI →	60 58 75 80 80 85 - 90 85 - 90 95	04/00→05/06 02/96→05/06 05/97→05/06 04/00→05/06 04/00→05/06 02/96→05/06 02/96→05/06 05/97→05/06 04/00→05/06		→ A906425 / R400726 A906426 / R400727→			24.2125-1727.3 010723 24.2125-1728.3 010751	Ø 25,4 Ø 25,4













	kw					! #		
MERCEDES-BENZ - SPRINTER 4-t Kasten (B904) 02/95→05/12								
 Hauptbremszylinder								
413 CDI 4x4	95	04/00→05/06			→ A906425 / R400726		24.2125-1727.3 010723	Ø 25,4
414	105	02/96→05/06						
414 4x4	105	05/97→05/06			A906426 / R400727→		24.2125-1728.3 010751	Ø 25,4
414 D 4x4	90	05/97→05/06						
414 NGT	95	02/95→05/06						
416 CDI	115	04/00→05/06						
416 CDI 4x4	115	04/00→05/06						
410 D	75	02/96→05/06			09/96→; → A906425 / R400726		24.2125-1727.3 010723	Ø 25,4
					A906426 / R400727→		24.2125-1728.3 010751	Ø 25,4
MERCEDES-BENZ - SPRINTER 4-t Kasten (B907, B910) 02/18→								
 Hauptbremszylinder								
411 CDI	84	02/18→					24.2126-1708.3 011128	Ø 27 ohne Bremsflüssigkeitsbehälter
411 CDI RWD	84	02/18→						
414 CDI	105	02/18→						
414 CDI All-wheel Drive	105	01/19→						
414 CDI RWD	105	02/18→						
415 CDI	110	10/21→						
415 CDI RWD	110	10/21→						
416 CDI All-wheel Drive	120	01/19→						
416 CDI RWD	120	02/18→						
417 CDI RWD	125	06/20→						
419 CDI All-wheel Drive	140	01/19→						
419 CDI RWD	140	02/18→						
MERCEDES-BENZ - SPRINTER 4-t Pritsche/Fahrgestell (B904) 02/95→05/12								
 Hauptbremszylinder								
408 CDI	60	04/00→05/06			→ A906425 / R400726		24.2125-1727.3 010723	Ø 25,4
408 D	58	02/96→05/06						
410 D 4x4	75	05/97→05/06			A906426 / R400727→		24.2125-1728.3 010751	Ø 25,4
411 CDI	80	04/00→05/06						
411 CDI 4x4	80	04/00→05/06						
412 D	85 - 90	02/96→05/06						
412 D 4x4	85 - 90	05/97→05/06						
413 CDI	95	04/00→05/06						
413 CDI 4x4	95	04/00→05/06						
414	105	02/95→05/06						
414 4x4	105	05/97→05/06						
416 CDI	115	04/00→05/06						
416 CDI 4x4	115	04/00→05/06						
410 D	75	02/96→05/06			09/96→; → A906425 / R400726		24.2125-1727.3 010723	Ø 25,4
					A906426 / R400727→		24.2125-1728.3 010751	Ø 25,4
MERCEDES-BENZ - SPRINTER 4-t Pritsche/Fahrgestell (B907, B910) 02/18→								
 Hauptbremszylinder								
411 CDI	84	02/18→					24.2126-1708.3 011128	Ø 27 ohne Bremsflüssigkeitsbehälter
411 CDI RWD	84	02/18→						
414 CDI	105	02/18→						
414 CDI All-wheel Drive	105	01/19→						
414 CDI RWD	105	02/18→						
415 CDI	110	06/20→						
415 CDI RWD	110	10/21→						
416 CDI All-wheel Drive	120	01/19→						
416 CDI RWD	120	02/18→						
417 CDI	125	02/18→						
417 CDI RWD	125	10/21→						
418 CDI	130	02/18→						
419 CDI All-wheel Drive	140	01/19→						
419 CDI RWD	140	02/18→						
MERCEDES-BENZ - SPRINTER 4-t Tourer Bus (B907) 02/18→								
 Hauptbremszylinder								
411 CDI	84	02/18→					24.2126-1708.3 011128	Ø 27 ohne Bremsflüssigkeitsbehälter
414 CDI	105	09/19→						
419 CDI	140	02/18→						
MERCEDES-BENZ - SPRINTER 5-t Bus (B906) 06/06→09/20								
 Hauptbremszylinder								
513 CDI	95	03/09→12/16			→ 09/09		24.2125-1750.3 011050	Ø 25,4 ohne Bremsflüssigkeitsbehälter
515 CDI	110	06/06→09/20						
516 CDI	120	03/09→12/18						
519 CDI	140	03/09→12/18			10/09→		24.2126-1704.3 010990	TRW Ø 27
							24.2126-1708.3 011128	Ø 27 ohne Bremsflüssigkeitsbehälter



























	kw			 	! #		
MERCEDES-BENZ - SPRINTER 5-t Kasten (B906) 06/06→09/20							
 Hauptbremszylinder							
509 CDI	65	06/06→12/09		→ 09/09		24.2125-1750.3 011050	Ø 25,4 ohne Bremsflüssigkeitsbehälter
510 CDI	70	03/09→12/16					
511 CDI	80	06/06→12/09		10/09→		24.2126-1704.3 010990	TRW Ø 27
511 CDI 4x4	80	06/06→12/09				24.2126-1708.3 011128	Ø 27 ohne Bremsflüssigkeitsbehälter
513 CDI	95	03/09→05/16					
513 CDI 4x4	95	03/09→12/16					
515 CDI	110	06/06→12/09					
515 CDI 4x4	110	06/06→12/09					
516	115	03/09→12/18					
516 CDI	120	03/09→12/18					
516 CDI 4x4	120	03/09→12/18					
516 NGT	115	03/09→12/18					
518 CDI	135	06/06→12/09					
518 CDI 4x4	135	06/06→12/16					
519 CDI / BlueTEC	140	03/09→12/18					
519 CDI / BlueTEC 4x4	140	03/09→12/18					
524	190	06/06→12/16					
511 CDI	84	05/16→12/18				24.2126-1704.3 010990	TRW Ø 27
514 CDI	105	05/16→12/18				24.2126-1708.3 011128	Ø 27 ohne Bremsflüssigkeitsbehälter
514 CDI 4x4	105	05/16→12/18					
515 CDI	110	06/11→09/20					
513 CDI	95	06/06→12/16		03/09→ 09/09		24.2125-1750.3 011050	Ø 25,4 ohne Bremsflüssigkeitsbehälter
				10/09→		24.2126-1704.3 010990	TRW Ø 27
						24.2126-1708.3 011128	Ø 27 ohne Bremsflüssigkeitsbehälter
MERCEDES-BENZ - SPRINTER 5-t Kasten (B907) 02/18→							
 Hauptbremszylinder							
511 CDI	84	02/18→				24.2126-1708.3 011128	Ø 27 ohne Bremsflüssigkeitsbehälter
514 CDI	105	02/18→					
515 CDI	110	10/21→					
516 CDI	120	02/18→					
516 CDI All-wheel Drive	120	01/19→					
517 CDI	125	06/20→					
519 CDI	140	02/18→					
519 CDI All-wheel Drive	140	01/19→					
MERCEDES-BENZ - SPRINTER 5-t Pritsche/Fahrgestell (B906) 06/06→09/20							
 Hauptbremszylinder							
509 CDI	65	06/06→12/09		→ 09/09		24.2125-1750.3 011050	Ø 25,4 ohne Bremsflüssigkeitsbehälter
510 CDI	70	03/09→12/16					
511 CDI	80	06/06→12/09		10/09→		24.2126-1704.3 010990	TRW Ø 27
511 CDI 4x4	80	06/06→12/09				24.2126-1708.3 011128	Ø 27 ohne Bremsflüssigkeitsbehälter
513 CDI	95	03/09→05/16					
515 CDI	110	06/06→12/09					
515 CDI 4x4	110	06/06→12/09					
516	115	09/08→12/18					
516 CDI	120	03/09→12/18					
516 NGT	115	09/08→12/18					
518 CDI	135	06/06→12/09					
518 CDI 4x4	135	06/06→12/09					
519 CDI / BlueTEC	140	03/09→12/18					
519 CDI / BlueTEC 4x4	140	03/09→12/18					
524	190	06/06→12/16					
511 CDI	84	05/16→12/18				24.2126-1704.3 010990	TRW Ø 27
513 CDI 4x4	95	05/11→12/16				24.2126-1708.3 011128	Ø 27 ohne Bremsflüssigkeitsbehälter
514 CDI	105	05/16→12/18					
514 CDI 4x4	105	05/16→12/18					
515 CDI	110	06/11→09/20					
516 CDI 4x4	120	03/09→12/18					
513 CDI	95	06/06→12/16		03/09→ 09/09		24.2125-1750.3 011050	Ø 25,4 ohne Bremsflüssigkeitsbehälter
				10/09→		24.2126-1704.3 010990	TRW Ø 27
						24.2126-1708.3 011128	Ø 27 ohne Bremsflüssigkeitsbehälter
MERCEDES-BENZ - SPRINTER 5-t Pritsche/Fahrgestell (B907) 02/18→							
 Hauptbremszylinder							
511 CDI	84	02/18→				24.2126-1708.3 011128	Ø 27 ohne Bremsflüssigkeitsbehälter
514 CDI	105	02/18→					
515 CDI RWD	110	10/21→					
516 CDI	120	02/18→					
516 CDI All-wheel Drive	120	01/19→					
519 CDI	140	02/18→					
519 CDI All-wheel Drive	140	01/19→					
519 CDI RWD	140	10/21→					











	kW			 	! #		
MERCEDES-BENZ - Vaneo (414) 02/02→07/05							
 Hauptbremszylinder							
1.6	60 - 75	02/02→07/05				24.4123-1703.3 010831	TRW Ø 23,8
1.7 CDI	55 - 67	02/02→07/05					
1.9	92	02/02→07/05					
MERCEDES-BENZ - VARIO Bus (B670) 08/96→							
 Hauptbremszylinder							
O 810	75	09/96→12/10				03.2128-1203.3 010922	ATE Ø 28,6
O 812	90	09/96→12/10					
O 813	95	01/06→12/13					
O 814	100	09/96→12/10					
O 815	112	09/96→12/10					
O 816 D	115	01/06→12/13					
O 818 D	130	09/06→		→ 12/13		03.2128-1203.3 010922	ATE Ø 28,6
MERCEDES-BENZ - VARIO Kasten (B667, B670, B668) 09/96→							
 Hauptbremszylinder							
512 D	90	09/96→12/10				03.2128-1203.3 010922	ATE Ø 28,6
612 D	90	09/96→12/10					
613 D	95 - 100	09/96→12/13					
614 D	95 - 100	09/96→12/13					
615 D	112 - 115	09/98→12/13					
616 D	112 - 115	09/98→12/13					
618 D	130	09/06→12/13					
812 D	90	09/96→12/10					
813 D	95 - 100	09/96→12/13					
814 D	95 - 100	09/96→12/13					
814 DA 4x4	95 - 100	09/96→12/13					
813 DA	95 - 100	09/96→12/13					
815 D	112 - 115	09/96→12/13					
816 D	112 - 115	09/96→12/13					
815 DA	112 - 115	09/96→12/13					
816 DA 4x4	112 - 115	09/96→12/13					
818 D	130	09/06→12/13					
MERCEDES-BENZ - VARIO Kipper 09/96→							
 Hauptbremszylinder							
612 D	90	09/96→12/10				03.2128-1203.3 010922	ATE Ø 28,6
613 D	95 - 100	09/96→12/13					
614 D	95 - 100	09/96→12/13					
812 D	90	09/96→12/10					
813 D	95 - 100	09/96→12/13					
814 D	95 - 100	09/96→12/13					
814 DA 4x4	95 - 100	09/96→12/13					
813 DA	95 - 100	09/96→12/13					
815 D	115	09/96→12/13					
816 D	115	09/96→12/13					
815 DA	112 - 115	09/96→12/13					
816 DA 4x4	112 - 115	09/96→12/13					
618 D	130	09/06→		→ 12/13		03.2128-1203.3 010922	ATE Ø 28,6
818 D	130	09/06→					
818 DA 4x4	130	09/06→					
MERCEDES-BENZ - VARIO Pritsche/Fahrgestell (B670, B668, B667) 09/96→							
 Hauptbremszylinder							
512 D	90	09/96→12/10				03.2128-1203.3 010922	ATE Ø 28,6
612 D	90	09/96→12/10					
→							

















	kW					! #		
MERCEDES-BENZ - VARIO Pritsche/Fahrgestell (B670, B668, B667) 09/96→								
 Hauptbremszylinder								
613 D	100	09/96→12/11					03.2128-1203.3 010922	ATE Ø 28,6
614 D	100	09/96→12/11						
812 D	90	09/96→12/10						
813 D	95 - 100	09/96→12/13						
814 D	95 - 100	09/96→12/13						
814 DA 4x4	95 - 100	09/96→12/13						
813 DA	95 - 100	09/96→12/13						
815 D	110 - 115	09/96→12/13						
816 D	112 - 115	09/96→12/13						
815 DA	112 - 115	09/96→12/13						
816 DA 4x4	112 - 115	09/96→12/13						
618 D	130	09/06→		→ 12/13			03.2128-1203.3 010922	ATE Ø 28,6
818 D	130	09/06→						
818 DA 4x4	130	09/06→						
MERCEDES-BENZ - VARIO Triebkopf 09/96→								
 Hauptbremszylinder								
613 D	95	01/06→12/13					03.2128-1203.3 010922	ATE Ø 28,6
614 D	95	01/06→12/13						
615 D	115	01/06→12/13						
616 D	115	01/06→12/13						
618 D	130	09/06→12/13						
810 DT	75	09/96→06/06						
812 DT	90	09/96→06/06						
814 DT	100	09/96→06/06						
816 DT	112	09/96→06/06						
MERCEDES-BENZ - VIANO (W639) 09/03→								
 Hauptbremszylinder								
3.2	140 - 160	09/03→		→ 02/14			24.2123-1772.3 010858	BOS Ø 23,8
3.5	190	09/07→						
3.7	170	06/04→						
CDI 2.0	80	09/03→						
CDI 2.2	100 - 120	09/03→						
CDI 2.2 4-matic	100 - 120	07/10→						
CDI 3.0	150 - 165	03/06→						
3.7	165	06/04→07/07					24.2123-1772.3 010858	BOS Ø 23,8
CDI 2.0	85	08/05→						
CDI 2.0 4-matic	85	03/06→						
CDI 2.2	110	01/14→						
CDI 2.0 4-matic	80	07/05→		07/10→ 02/14			24.2123-1772.3 010858	BOS Ø 23,8
CDI 2.2 4-matic	110	07/05→						
CDI 2.2	70	09/10→		→ 3558104			24.2123-1772.3 010858	BOS Ø 23,8
				3558105→; → 02/14			24.2123-1778.3 010947	TRW Ø 23,8
MERCEDES-BENZ - VITO / MIXTO Kasten (W639) 08/03→								
 Hauptbremszylinder								
109 CDI	65 - 70	09/03→		→ 3558104			24.2123-1772.3 010858	BOS Ø 23,8
110 CDI	70	09/10→		3558105→; → 02/14			24.2123-1778.3 010947	TRW Ø 23,8
111 CDI	80 - 85	09/03→						
111 CDI 4x4	80	09/07→						
113 CDI	100	09/10→						
113 CDI 4x4	100	09/10→						
115 CDI	110	09/03→						
116 CDI	120	09/10→						
116 CDI 4x4	120	09/10→						
119	140	09/03→						
122	160	09/03→						
122 CDI	165	09/10→						
126	190	09/07→						
115 CDI 4x4	110	07/06→		09/07→; → 3558104			24.2123-1772.3 010858	BOS Ø 23,8
120 CDI	150	07/06→		3558105→; → 02/14			24.2123-1778.3 010947	TRW Ø 23,8
123	165 - 170	06/04→07/08		→ 3558104			24.2123-1772.3 010858	BOS Ø 23,8
				3558105→			24.2123-1778.3 010947	TRW Ø 23,8















	kW					! #					
MERCEDES-BENZ - VITO Bus (W638) 02/96→07/03											
 Hauptbremszylinder											
108 CDI 2.2	60	03/99→07/03		- ABS			24.2123-1712.3 010519	Ø 23,8			
110 CDI 2.2	75	03/99→07/03		+ ABS			24.2123-1729.3 010567	Ø 23,8			
112 CDI 2.2	90	03/99→07/03									
114 2.3	105	12/96→07/03									
108 D 2.3	58	02/96→07/03		03/96→; - ABS			24.2123-1712.3 010519	Ø 23,8			
110 TD 2.3	72	02/96→07/03		03/96→; + ABS			24.2123-1729.3 010567	Ø 23,8			
113 2.0	95	02/96→07/03									
MERCEDES-BENZ - VITO Bus (W639) 09/03→											
 Hauptbremszylinder											
109 CDI	65 - 70	09/03→		→ 3558104			24.2123-1772.3 010858	BOS Ø 23,8			
109 CDI 4x4	70	09/07→08/14		3558105→; → 02/14			24.2123-1778.3 010947	TRW Ø 23,8			
110 CDI	70	09/10→08/14									
111 CDI	80 - 85	09/03→									
111 CDI 4x4	80	09/07→08/14									
113 CDI	100	09/10→									
113 CDI 4x4	100	09/10→08/14									
115 CDI	110	09/03→									
115 CDI 4x4	110	09/07→08/14									
116 CDI	120	09/10→									
116 CDI 4x4	120	09/10→08/14									
119	140	09/03→									
122	160	09/03→									
122 CDI	165	09/10→									
126	190	09/07→									
120 CDI	150	07/06→			09/07→; → 3558104					24.2123-1772.3 010858	BOS Ø 23,8
					3558105→; → 02/14					24.2123-1778.3 010947	TRW Ø 23,8
123	165 - 170	06/04→07/08			→ 3558104					24.2123-1772.3 010858	BOS Ø 23,8
				3558105→			24.2123-1778.3 010947	TRW Ø 23,8			
MERCEDES-BENZ - VITO Kasten (W638) 03/97→07/03											
 Hauptbremszylinder											
108 CDI 2.2	60	03/99→07/03		- ABS			24.2123-1712.3 010519	Ø 23,8			
108 D 2.3	58	03/97→07/03		+ ABS			24.2123-1729.3 010567	Ø 23,8			
110 CDI 2.2	75	03/99→07/03									
110 D 2.3	72	03/97→07/03									
112 CDI 2.2	90	03/99→07/03									
113 2.0	95	03/97→07/03									
114 2.3	105	03/97→07/03									
MERCEDES-BENZ - V-KLASSE (638/2) 02/96→07/03											
 Hauptbremszylinder											
V 200	95	02/97→07/03		- ABS			24.2123-1712.3 010519	Ø 23,8			
V 200 CDI	75	03/99→07/03		+ ABS			24.2123-1729.3 010567	Ø 23,8			
V 220 CDI	90	03/99→07/03									
V 230	105	10/96→07/03									
V 230 TD	72	09/96→07/03									
V 280	128	08/97→07/03		09/97→; - ABS			24.2123-1712.3 010519	Ø 23,8			
				09/97→; + ABS			24.2123-1729.3 010567	Ø 23,8			
MINI - MINI (F55) 09/13→											
 Hauptbremszylinder											
Cooper	100	09/13→		10/14→			24.4122-1722.3 011085	Ø 22,2 ohne Bremsflüssigkeitsbehälter			
Cooper D	85	10/13→									
Cooper S	120 - 141	09/13→									
Cooper SD	120 - 125	09/13→									
One	75	05/14→10/17									
One D	70	02/14→									
Cooper S	131	11/20→			24.4122-1722.3 011085				24.4122-1722.3 011085	Ø 22,2 ohne Bremsflüssigkeitsbehälter	
One	75	11/17→									
One First	55	11/17→									
Cooper S JCW	155	09/13→			09/15→					24.4123-1733.3 011108	Ø 23,8 ohne Bremsflüssigkeitsbehälter
One First	55	06/14→10/17		03/15→			24.4122-1722.3 011085	Ø 22,2 ohne Bremsflüssigkeitsbehälter			
MINI - MINI (F56) 12/13→											
 Hauptbremszylinder											
Cooper S	131	11/20→					24.4122-1722.3 011085	Ø 22,2 ohne Bremsflüssigkeitsbehälter			
→											

















	kw			 	! #		
MINI - MINI (F56) 12/13→							
 Hauptbremszylinder							
Cooper SE / Electric	75 - 135	11/19→				24.4122-1722.3 011085	Ø 22,2 ohne Bremsflüssigkeitsbehälter
Cooper S JCW	155	12/13→		03/15→		24.4123-1733.3 011108	Ø 23,8 ohne Bremsflüssigkeitsbehälter
John Cooper Works John Cooper Works GP	170 225	03/15→ 03/20→				24.4123-1733.3 011108	Ø 23,8 ohne Bremsflüssigkeitsbehälter
MINI - MINI (R50, R53) 06/01→09/06							
 Bremskraftverstärker							
Cooper Cooper S John Cooper Works One	85 125 160 55 - 66	06/01→09/06 07/04→09/06 03/06→09/06 06/01→09/06				03.7860-1402.4 300228	ATE Ø 10" pneumatisch
One D	55 - 65	06/03→09/06					
S Works Works	149 155	11/03→06/05 11/03→09/06					
Cooper S	120	03/02→09/06		07/02→		03.7860-1402.4 300228	ATE Ø 10" pneumatisch
 Hauptbremszylinder							
Cooper Cooper S John Cooper Works One	85 125 160 55 - 66	06/01→09/06 07/04→09/06 03/06→09/06 06/01→09/06		+ DSC		03.2122-1824.3 010892	ATE Ø 22,2
One D	55 - 65	06/03→09/06		- DSC		03.2122-1853.3 010893	ATE Ø 22,2
S Works Works	149 155	11/03→06/05 11/03→09/06					
Cooper S	120	03/02→09/06		07/02→; + DSC		03.2122-1824.3 010892	ATE Ø 22,2
				07/02→; - DSC		03.2122-1853.3 010893	ATE Ø 22,2
MINI - MINI (R56) 11/05→01/14							
 Hauptbremszylinder							
Cooper	85 - 90	09/06→11/13		03/10→		24.4123-1712.3 010897	TRW Ø 23,8
One D	66	06/09→07/10					
Cooper Cooper S	88 128	10/06→02/12 10/06→02/10		11/06→		24.4123-1712.3 010897	TRW Ø 23,8
Cooper D One	80 70	11/06→09/10 11/06→03/10		04/07→		24.4123-1712.3 010897	TRW Ø 23,8
Cooper D Cooper S	82 120 - 135	06/10→11/13 03/10→11/13				24.4123-1712.3 010897	TRW Ø 23,8
Cooper SD	100 - 105	02/11→11/13					
Cooper S John Cooper Works One	147 55 - 72	01/12→11/13 03/09→11/13					
One D One LPG	66 55	07/10→11/13 03/09→03/10					
Cooper S John Cooper Works John Cooper Works	141 155	11/06→02/10 11/07→11/13		03/08→		24.4123-1712.3 010897	TRW Ø 23,8
MINI - MINI Cabriolet (F57) 11/14→							
 Hauptbremszylinder							
Cooper Cooper D Cooper S	100 85 120 - 141	11/14→ 12/14→ 11/14→		11/15→		24.4122-1722.3 011085	Ø 22,2 ohne Bremsflüssigkeitsbehälter
Cooper S Cooper SE One	131 135 75	11/20→ 04/23→ 11/17→				24.4122-1722.3 011085	Ø 22,2 ohne Bremsflüssigkeitsbehälter
Cooper SD One	120 - 125 75	05/15→ 06/15→10/17		03/16→		24.4122-1722.3 011085	Ø 22,2 ohne Bremsflüssigkeitsbehälter
Cooper S JCW John Cooper Works	155 170	11/14→ 05/15→		03/16→		24.4123-1733.3 011108	Ø 23,8 ohne Bremsflüssigkeitsbehälter















	kw			 	! #		
MINI - MINI Cabriolet (R52) 04/04→07/08							
 Bremskraftverstärker							
Cooper Cooper S	85 120 - 125	04/04→07/08 07/04→07/08				03.7860-1402.4 300228	ATE Ø 10" pneumatisch
John Cooper Works One	155 66	07/04→11/07 07/04→11/07					
 Hauptbremszylinder							
Cooper Cooper S	85 120 - 125	04/04→07/08 07/04→07/08		+ DSC		03.2122-1824.3 010892	ATE Ø 22,2
John Cooper Works One	155 66	07/04→11/07 07/04→11/07		- DSC		03.2122-1853.3 010893	ATE Ø 22,2
MINI - MINI Cabriolet (R57) 10/07→06/15							
 Hauptbremszylinder							
Cooper Cooper S	85 128	12/08→06/15 12/08→07/10		01/09→		24.4123-1712.3 010897	TRW Ø 23,8
Cooper Cooper S	88 - 90 141	12/08→06/15 04/08→07/10				24.4123-1712.3 010897	TRW Ø 23,8
Cooper D	82	05/09→11/13		06/10→		24.4123-1712.3 010897	TRW Ø 23,8
Cooper D	82	02/11→05/15		→ 06/14		24.4123-1712.3 010897	TRW Ø 23,8
Cooper S	120	10/07→06/15		01/09→ 06/14		24.4123-1712.3 010897	TRW Ø 23,8
Cooper S	135 - 147	02/10→06/15		03/10→ 06/14		24.4123-1712.3 010897	TRW Ø 23,8
One	72	09/09→06/15					
Cooper SD	100 - 105	06/09→05/15		02/11→ 06/14		24.4123-1712.3 010897	TRW Ø 23,8
John Cooper Works	155	08/08→05/15		03/09→ 06/14		24.4123-1712.3 010897	TRW Ø 23,8
MINI - MINI CLUBMAN (F54) 11/14→							
 Hauptbremszylinder							
Cooper Cooper D	100 100 - 110	12/14→ 12/14→		07/15→		24.4122-1722.3 011085	Ø 22,2 ohne Bremsflüssigkeitsbehälter
Cooper S	120 - 141	11/14→					
Cooper S JCW	155	11/14→06/18					
Cooper S Cooper S ALL4	131 131	11/20→ 11/20→				24.4122-1722.3 011085	Ø 22,2 ohne Bremsflüssigkeitsbehälter
Cooper S ALL4	120 - 141	04/15→		01/16→		24.4122-1722.3 011085	Ø 22,2 ohne Bremsflüssigkeitsbehälter
Cooper SD ALL4	120 - 140	04/15→					
Cooper S JCW ALL4	155	11/14→					
Cooper SD	120 - 140	02/15→		11/15→		24.4122-1722.3 011085	Ø 22,2 ohne Bremsflüssigkeitsbehälter
One One D	75 85	02/15→ 02/15→					
John Cooper Works	170	11/16→06/19				24.4123-1733.3 011108	Ø 23,8 ohne Bremsflüssigkeitsbehälter
MINI - MINI CLUBMAN (R55) 10/06→12/15							
 Hauptbremszylinder							
Cooper	85 - 90	10/07→06/14				24.4123-1712.3 010897	TRW Ø 23,8
Cooper D	80 - 82	10/07→06/14					
Cooper S	120 - 147	08/07→06/14					
Cooper SD	100 - 105	02/11→06/14					
Cooper S John Cooper Works	141	10/08→02/10					
One One D	72 66	03/10→06/14 03/10→06/14					
John Cooper Works	155	11/07→06/14		03/08→		24.4123-1712.3 010897	TRW Ø 23,8
MINI - MINI CLUBVAN (R55) 12/12→06/14							
 Hauptbremszylinder							
Cooper Cooper D One	90 82 72	12/12→06/14 12/12→06/14 12/12→06/14				24.4123-1712.3 010897	TRW Ø 23,8













	kw			 	! #		
MINI - MINI COUNTRYMAN (F60) 10/16→							
 Hauptbremszylinder							
Cooper	100	10/16→				24.4123-1733.3 011108	Ø 23,8 ohne Bremsflüssigkeitsbehälter
Cooper ALL4	100	10/16→					
Cooper D	100 - 110	10/16→					
Cooper D ALL4	100 - 110	10/16→					
Cooper S	120 - 141	10/16→					
Cooper S ALL4	120 - 141	10/16→					
Cooper SD	120 - 140	10/16→					
Cooper SD ALL4	120 - 140	10/16→					
Cooper SE	162	07/20→					
Cooper SE ALL4	165	01/17→					
John Cooper Works ALL4	170	03/17→06/19					
One	75	07/17→					
One D	85	07/17→					
MINI - MINI COUNTRYMAN (R60) 08/10→10/16							
 Hauptbremszylinder							
Cooper	85 - 90	08/10→10/16		09/10→		24.4123-1712.3 010897	TRW Ø 23,8
Cooper D	82	08/10→10/16					
Cooper D ALL4	82	08/10→10/16					
Cooper S	120 - 135	08/10→10/16					
Cooper S ALL4	120 - 135	08/10→10/16					
One	72	08/10→10/16					
One D	66	08/10→10/16					
Cooper ALL4	90	11/12→10/16		11/14→		24.4123-1712.3 010897	TRW Ø 23,8
Cooper D	82	03/11→10/16				24.4123-1712.3 010897	TRW Ø 23,8
Cooper D ALL4	82	03/11→10/16					
Cooper S	140	07/14→10/16					
Cooper S ALL4	140	07/14→10/16					
Cooper SD	100 - 105	03/11→10/16					
Cooper SD ALL4	100 - 105	03/11→10/16					
John Cooper Works ALL4	160	11/12→10/16					
Cooper S	147	08/10→10/16		02/12→		24.4123-1712.3 010897	TRW Ø 23,8
MINI - MINI Coupe (R58) 12/10→05/15							
 Hauptbremszylinder							
1.6 Cooper	88	10/14→05/15				24.4123-1712.3 010897	TRW Ø 23,8
Cooper	85 - 90	12/10→04/15		10/11→		24.4123-1712.3 010897	TRW Ø 23,8
Cooper S	120 - 135	12/10→04/15					
Cooper SD	100 - 105	12/10→05/15					
Cooper S JCW	147	12/10→04/15					
John Cooper Works	155	12/10→05/15					
MINI - MINI PACEMAN (R61) 03/12→10/16							
 Hauptbremszylinder							
Cooper	88 - 90	04/12→09/16		11/12→		24.4123-1712.3 010897	TRW Ø 23,8
Cooper D	82	04/12→09/16					
Cooper D ALL4	82	03/12→09/16					
Cooper S ALL4	120 - 140	03/12→09/16					
Cooper SD	105	03/12→09/16					
Cooper SD ALL4	100 - 105	04/12→09/16					
Cooper ALL4	85 - 90	11/12→09/16		07/14→		24.4123-1712.3 010897	TRW Ø 23,8
Cooper S	120 - 140	11/12→10/16				24.4123-1712.3 010897	TRW Ø 23,8
John Cooper Works ALL4	160	03/13→10/16					













	kw					! #		
MINI - MINI Roadster (R59) 01/11→04/15								
 Hauptbremszylinder								
Cooper	85 - 90	11/11→04/15		02/12→			24.4123-1712.3 010897	TRW Ø 23,8
Cooper S	120 - 135	11/11→04/15						
Cooper SD	100 - 105	11/11→04/15						
Cooper S JCW	147	11/11→04/15						
John Cooper Works	155	11/11→04/15						
MITSUBISHI - CARISMA (DA_) 05/95→06/06								
 Hauptbremszylinder								
1.6	66	07/95→06/06		- ABS			24.2122-1718.3 010517	Ø 22,2
MITSUBISHI - CARISMA Stufenheck (DA_) 09/96→06/06								
 Hauptbremszylinder								
1.6	66	09/96→06/06		- ABS			24.2122-1718.3 010517	Ø 22,2
MITSUBISHI - COLT VI (Z3_A, Z2_A) 10/02→12/12								
 Hauptbremszylinder								
1.1	55	10/04→06/12		→ 09/08			24.2122-1770.3 010898	TRW Ø 22,2
1.1 LPG	55	10/04→06/12		10/08→			24.4122-1717.3 010993	TRW Ø 22,2 ohne Bremsflüssigkeitsbehälter
1.3	68 - 70	06/04→06/12						
1.3 LPG	70	06/04→06/12						
1.5	77 - 80	06/04→06/12						
1.5 CZT	110	03/05→06/12						
1.3 Flexfuel	70	10/08→06/12		für Linkslenker			24.4122-1717.3 010993	TRW Ø 22,2 ohne Bremsflüssigkeitsbehälter
1.5 Ralliart R	132	02/10→06/12						
1.5 DI-D	50 - 70	08/04→06/12					24.2122-1770.3 010898	TRW Ø 22,2
MITSUBISHI - COLT CZC VI Cabriolet (RG) 05/06→07/09								
 Hauptbremszylinder								
1.5	80	05/06→07/09					24.2122-1770.3 010898	TRW Ø 22,2
1.5 Turbo	110	05/06→07/09						
MITSUBISHI - COLT Kasten/Schrägheck (Z3_V) 08/04→06/12								
 Hauptbremszylinder								
1.5 DiD	70	08/04→06/12					24.2122-1770.3 010898	TRW Ø 22,2
NISSAN - BLUEBIRD SYLPHY / SYLPHY III (B17) 07/12→								
 Hauptbremszylinder								
1.6	86	05/13→		für Linkslenker; CVT-Automatikgetriebe (stufenlos)			24.4123-1727.3 011088	Ø 23,8 ohne Bremsflüssigkeitsbehälter
NISSAN - INTERSTAR Bus (X70) 04/02→								
 Hauptbremszylinder								
dCi 100	73	11/03→03/06		- ABS			24.2025-1708.3 010692	Ø 25,4
dCi 120	88	09/06→03/11		+ ABS			24.2123-1759.3 010768	BOS Ø 23,8
dCi 100	74	04/06→03/11		→ 06/10; - ABS			24.2025-1708.3 010692	Ø 25,4
dCi 150	107	09/06→03/11		→ 06/10; + ABS			24.2123-1759.3 010768	BOS Ø 23,8
dCi 115	84	04/02→08/06		→ 12/02; + ABS			24.2025-1706.3 010676	Ø 25,4
dCi 80	60	04/02→08/06		- ABS			24.2025-1708.3 010692	Ø 25,4
dCi 90	66	07/02→08/06		01/03→; + ABS			24.2123-1759.3 010768	BOS Ø 23,8
dCi 140	100	11/03→		→ 08/06; - ABS			24.2025-1708.3 010692	Ø 25,4
				→ 08/06; + ABS			24.2123-1759.3 010768	BOS Ø 23,8
NISSAN - INTERSTAR Kasten (X70) 04/02→								
 Hauptbremszylinder								
dCi 100	73	11/03→03/06		- ABS			24.2025-1708.3 010692	Ø 25,4
dCi 120	88	09/06→		+ ABS			24.2123-1759.3 010768	BOS Ø 23,8
dCi 100	74	04/06→		→ 06/10; - ABS			24.2025-1708.3 010692	Ø 25,4
dCi 150	107	09/06→		→ 06/10; + ABS			24.2123-1759.3 010768	BOS Ø 23,8
dCi 115	84	04/02→		→ 12/02; + ABS			24.2025-1706.3 010676	Ø 25,4
dCi 90	66	07/02→		→ 08/06; - ABS			24.2025-1708.3 010692	Ø 25,4
→								

















	kw					! #		
NISSAN - INTERSTAR Kasten (X70) 04/02→								
 Hauptbremszylinder								
dCi 115 dCi 90	84 66	04/02→ 07/02→			01/03→ 08/06; + ABS		24.2123-1759.3 010768	BOS Ø 23,8
dCi 140	100	11/03→			→ 08/06; - ABS		24.2025-1708.3 010692	Ø 25,4
					→ 08/06; + ABS		24.2123-1759.3 010768	BOS Ø 23,8
dCi 80	60	04/02→08/06			→ 12/02; + ABS		24.2025-1706.3 010676	Ø 25,4
					- ABS		24.2025-1708.3 010692	Ø 25,4
					01/03→; + ABS		24.2123-1759.3 010768	BOS Ø 23,8
NISSAN - INTERSTAR Pritsche/Fahrgestell (X70) 08/03→								
 Hauptbremszylinder								
dCi 100	73	02/04→			→ 06/10; - ABS		24.2025-1708.3 010692	Ø 25,4
					→ 06/10; + ABS		24.2123-1759.3 010768	BOS Ø 23,8
dCi 115 dCi 140	84 100	08/03→ 11/03→			→ 08/06; - ABS		24.2025-1708.3 010692	Ø 25,4
					→ 08/06; + ABS		24.2123-1759.3 010768	BOS Ø 23,8
dCi 120	88	08/06→			- ABS		24.2025-1708.3 010692	Ø 25,4
					+ ABS		24.2123-1759.3 010768	BOS Ø 23,8
dCi 150	107	08/06→			09/06→ 06/10; - ABS		24.2025-1708.3 010692	Ø 25,4
					09/06→ 06/10; + ABS		24.2123-1759.3 010768	BOS Ø 23,8
NISSAN - KUBISTAR Kasten (X76) 08/03→								
 Hauptbremszylinder								
1.2 1.5 dCi	44 42 - 60	08/03→ 08/03→			→ 08/05; - ABS		24.2122-1727.3 010586	BDX Ø 22,2
1.2 16V	55	04/06→			→ 10/09; - ABS		24.2122-1727.3 010586	BDX Ø 22,2
1.4	55	08/03→10/09					24.2122-1727.3 010586	BDX Ø 22,2
1.5 dCi	45	08/05→10/09			09/05→; - ABS		24.2122-1727.3 010586	BDX Ø 22,2
1.5 dCi 70 1.6 16V dCi 85	50 70 62	09/05→10/09 08/03→10/09 04/06→10/09			- ABS		24.2122-1727.3 010586	BDX Ø 22,2
NISSAN - MICRA III (K12) 03/02→06/10								
 Bremskraftverstärker								
1.0 16V 1.2 1.2 16V	48 66 48 - 59	01/03→06/10 01/07→06/10 01/03→06/10			für Linkslenker		03.7863-3002.4 300223	ATE Ø 10" pneumatisch
1.2 LPG 1.3 1.4 1.4 16V 1.5 dCi	59 60 72 65 48 - 63	10/02→06/10 08/04→06/10 03/07→06/10 01/03→06/10 01/03→06/10						
160 SR	81	05/05→06/10						
 Hauptbremszylinder								
1.0 16V 1.2 1.2 16V	48 66 48 - 59	01/03→06/10 01/07→06/10 01/03→06/10			für Linkslenker; - ESP		03.2123-2863.3 010790	ATE Ø 23,8
					für Linkslenker; + ESP		03.2123-2923.3 010791	ATE Ø 23,8
1.2 LPG 1.3 1.4 1.4 16V 1.5 dCi	59 60 72 65 48 - 63	10/02→06/10 08/04→06/10 03/07→06/10 01/03→06/10 01/03→06/10						
160 SR	81	05/05→06/10						
NISSAN - MICRA C+C III (K12) 08/05→								
 Bremskraftverstärker								
1.4 16V 1.6 160 SR	65 81	08/05→ 08/05→			→ 12/10; für Linkslenker		03.7863-3002.4 300223	ATE Ø 10" pneumatisch
 Hauptbremszylinder								
1.4 16V 1.6 160 SR	65 81	08/05→ 08/05→			→ 12/10; - ESP		03.2123-2863.3 010790	ATE Ø 23,8
					→ 12/10; + ESP		03.2123-2923.3 010791	ATE Ø 23,8













	kw					! #		
NISSAN - NAVARA NP300 (D40) 10/04→								
 Hauptbremszylinder								
2.5 D 4WD	98	09/08→			für Linkslenker		03.2125-0161.3 010920	ATE Ø 25,4
2.5 dCi 4WD	106	01/07→						
2.5 dCi 4x4	120	02/12→12/16						
2.5 dCi	106 - 128	07/05→			→ 09/06		03.2125-0161.3 010920	ATE Ø 25,4
2.5 dCi 4WD	128	07/05→						
2.5 dCi	120	10/06→					03.2125-0161.3 010920	ATE Ø 25,4
NISSAN - NAVARA NP300 Pritsche/Fahrgestell (D40) 07/08→								
 Hauptbremszylinder								
2.5 dCi 4WD	106	08/08→			01/10→; für Linkslenker		03.2125-0161.3 010920	ATE Ø 25,4
NISSAN - NOTE (E11, NE11) 01/05→08/13								
 Bremskraftverstärker								
1.4	65	03/06→06/12			für Linkslenker		03.7863-3002.4 300223	ATE Ø 10" pneumatisch
1.4 LPG	65	01/06→08/13						
1.5	80	03/06→12/10						
1.5 dCi	50 - 76	03/06→06/12						
1.6	81	03/06→06/12						
 Hauptbremszylinder								
1.4	65	03/06→06/12			- ESP		03.2123-2863.3 010790	ATE Ø 23,8
1.4 LPG	65	01/06→08/13						
1.5	80	03/06→12/10			+ ESP		03.2123-2923.3 010791	ATE Ø 23,8
1.5 dCi	50 - 76	03/06→06/12						
1.6	81	03/06→06/12						
NISSAN - NOTE VAN (E11) 01/05→08/13								
 Bremskraftverstärker								
1.5 dCi	63	01/11→09/12			für Linkslenker		03.7863-3002.4 300223	ATE Ø 10" pneumatisch
 Hauptbremszylinder								
1.5 dCi	63	01/11→09/12			- ESP		03.2123-2863.3 010790	ATE Ø 23,8
					+ ESP		03.2123-2923.3 010791	ATE Ø 23,8
NISSAN - NP300 PICKUP (D22) 04/08→								
 Hauptbremszylinder								
2.5 dCi	98	04/08→					03.2125-0161.3 010920	ATE Ø 25,4
2.5 dCi 4x4	98	04/08→						
NISSAN - PATHFINDER III (R51) 01/05→								
 Hauptbremszylinder								
2.5 dCi	128	01/05→			für Linkslenker		03.2125-0531.3 010945	ATE Ø 25,4
2.5 dCi 4WD	126 - 128	03/05→						
2.5 dCi 4WD	120	01/05→					03.2125-0531.3 010945	ATE Ø 25,4
4.0	214	01/10→08/14						
4.0 4WD	198	09/05→						
2.5 dCi 4WD	140	08/10→					03.2125-0161.3 010920	ATE Ø 25,4
NISSAN - PATHFINDER III VAN (R51_) 01/05→								
 Hauptbremszylinder								
2.5 dCi 4x4	140	03/13→08/14			für Linkslenker		03.2125-0161.3 010920	ATE Ø 25,4
3.0 dCi 4x4	170	03/13→08/14						
NISSAN - PRIMASTAR Bus (X83) 03/01→								
 Hauptbremszylinder								
2.0	88	03/01→08/06			→ 01/03; - ABS		24.2120-1738.3 010759	TRW Ø 20,6
					02/03→; - ABS		24.2120-1740.3 010764	TRW Ø 20,6
					02/03→; + ABS		24.2125-1731.3 010826	TRW Ø 25,4
dCi 100	74	03/01→			→ 01/03; - ABS		24.2120-1738.3 010759	TRW Ø 20,6
dCi 80	60	03/01→			02/03→ 08/06; - ABS		24.2120-1740.3 010764	TRW Ø 20,6
					02/03→ 08/06; + ABS		24.2125-1731.3 010826	TRW Ø 25,4
dCi 115	84	09/08→			- ABS		24.2120-1740.3 010764	TRW Ø 20,6
dCi 120	84	09/06→						
dCi 150	107	09/06→			+ ABS		24.2125-1731.3 010826	TRW Ø 25,4
dCi 90	66	09/06→						
→								















	kw			 	! #		
NISSAN - PRIMASTAR Bus (X83) 03/01→							
 Hauptbremszylinder							
dCi 140	99	07/03→		→ 08/06; - ABS	24.2120-1740.3	010764	TRW Ø 20,6
				→ 08/06; + ABS	24.2125-1731.3	010826	TRW Ø 25,4
NISSAN - PRIMASTAR Kasten (X83) 09/02→							
 Hauptbremszylinder							
1.9 dCi 100	74	09/02→		→ 01/03; - ABS	24.2120-1738.3	010759	TRW Ø 20,6
1.9 dCi 80	60	09/02→		02/03→ 08/06; - ABS	24.2120-1740.3	010764	TRW Ø 20,6
				02/03→ 08/06; + ABS	24.2125-1731.3	010826	TRW Ø 25,4
2.0	88	02/03→		- ABS	24.2120-1740.3	010764	TRW Ø 20,6
2.0 dCi 115	84	09/06→		+ ABS	24.2125-1731.3	010826	TRW Ø 25,4
2.0 dCi 90	66	09/06→					
2.5 dCi 115	84	09/08→					
2.5 dCi 150	107	09/06→					
2.5 dCi 140	99	07/03→		→ 08/06; - ABS	24.2120-1740.3	010764	TRW Ø 20,6
				→ 08/06; + ABS	24.2125-1731.3	010826	TRW Ø 25,4
NISSAN - PRIMASTAR Pritsche/Fahrgestell (X83) 07/02→							
 Hauptbremszylinder							
1.9 dCi 100	74	07/02→08/06		→ 01/03; - ABS	24.2120-1738.3	010759	TRW Ø 20,6
1.9 dCi 80	60	07/02→08/06		02/03→; - ABS	24.2120-1740.3	010764	TRW Ø 20,6
				02/03→; + ABS	24.2125-1731.3	010826	TRW Ø 25,4
2.0	88	07/02→08/06		→ 09/03; - ABS	24.2120-1738.3	010759	TRW Ø 20,6
				10/03→; - ABS	24.2125-1731.3	010826	TRW Ø 25,4
2.5 dCi 140	99	07/02→08/06		- ABS	24.2120-1740.3	010764	TRW Ø 20,6
				+ ABS	24.2125-1731.3	010826	TRW Ø 25,4
2.5 dCi 150	107	04/06→		09/06→; - ABS	24.2120-1740.3	010764	TRW Ø 20,6
				09/06→; + ABS	24.2125-1731.3	010826	TRW Ø 25,4
NISSAN - PRIMERA (P12) 01/02→							
 Hauptbremszylinder							
1.6	78 - 80	01/02→08/08		06/04→	24.2122-1774.3	010987	Ø 22,2 ohne Bremsflüssigkeitsbehälter
1.8	85	03/02→10/08					
1.8 LPG	85	03/02→					
1.9 dCi	85 - 88	08/02→10/07					
2.0	103	03/02→10/08					
2.2 dCi	102	04/03→04/06					
NISSAN - PRIMERA Hatchback (P12) 01/02→							
 Hauptbremszylinder							
1.6	78 - 80	07/02→08/08		06/04→	24.2122-1774.3	010987	Ø 22,2 ohne Bremsflüssigkeitsbehälter
1.8	85	07/02→10/08					
1.9 dCi	85 - 88	08/02→10/07					
2.0	103	07/02→10/08					
2.2 dCi	102	04/03→		06/04→ 10/07	24.2122-1774.3	010987	Ø 22,2 ohne Bremsflüssigkeitsbehälter
NISSAN - PRIMERA Kombi (WP12) 01/02→							
 Hauptbremszylinder							
1.6 Visia	80	01/02→04/06		06/04→	24.2122-1774.3	010987	Ø 22,2 ohne Bremsflüssigkeitsbehälter
1.8	85	03/02→05/07					
1.9 dCi	85	08/02→10/07					
1.9 dCi	88	04/03→		06/04→ 10/07	24.2122-1774.3	010987	Ø 22,2 ohne Bremsflüssigkeitsbehälter
2.2 dCi	102	04/03→					
2.0	103	03/02→		06/04→ 10/08	24.2122-1774.3	010987	Ø 22,2 ohne Bremsflüssigkeitsbehälter
NISSAN - PULSAR Schrägheck (C13) 10/14→							
 Hauptbremszylinder							
1.6 CVTC	86	08/12→		für Linkslenker; CVT-Automatikgetriebe (stufenlos)	24.4123-1727.3	011088	Ø 23,8 ohne Bremsflüssigkeitsbehälter

	kW					! #		
NISSAN - QASHQAI / QASHQAI +2 I (J10, NJ10, JJ10E) 11/06→04/14								
 Hauptbremszylinder								
1.5 dCi	76 - 81	11/06→12/13		+ ESP; für Linkslenker		24.4123-1725.3	011073	Ø 23,8 ohne Bremsflüssigkeitsbehälter
1.6	81 - 86	02/07→12/13		- ESP; für Linkslenker		24.4123-1729.3	011106	Ø 23,8 ohne Bremsflüssigkeitsbehälter
1.6 LPG	86	11/10→12/13						
2.0	102 - 104	02/07→12/13						
2.0 All-wheel Drive	102 - 104	02/07→12/13						
2.0 dCi	110	02/07→12/13						
2.0 dCi All-wheel Drive	110	02/07→12/13						
1.6	84	02/07→12/13		+ ESP; für Linkslenker; 01/10→		24.4123-1725.3	011073	Ø 23,8 ohne Bremsflüssigkeitsbehälter
				- ESP; für Linkslenker		24.4123-1729.3	011106	Ø 23,8 ohne Bremsflüssigkeitsbehälter
1.6 dCi	96	10/11→12/13		für Linkslenker		24.4123-1725.3	011073	Ø 23,8 ohne Bremsflüssigkeitsbehälter
1.6 dCi All-wheel Drive	96	10/11→12/13						
2.0	103	01/10→04/14		für Linkslenker; Schaltgetriebe; für Fahrzeuge mit Adaptive Cruise Control		24.4123-1725.3	011073	Ø 23,8 ohne Bremsflüssigkeitsbehälter
2.0 All-wheel Drive	103	01/10→04/14		für Linkslenker; Schaltgetriebe; für Fahrzeuge ohne Adaptive Cruise Control		24.4123-1729.3	011106	Ø 23,8 ohne Bremsflüssigkeitsbehälter
NISSAN - QASHQAI / QASHQAI +2 I VAN (J10, JJ10E) 12/06→04/14								
 Hauptbremszylinder								
1.5 dCi	81	03/13→04/14		+ ESP; für Linkslenker		24.4123-1725.3	011073	Ø 23,8 ohne Bremsflüssigkeitsbehälter
1.6 CVT	86	03/13→04/14						
2.0	104	03/13→04/14		→ 01/14; - ESP; für Linkslenker		24.4123-1729.3	011106	Ø 23,8 ohne Bremsflüssigkeitsbehälter
2.0 All-wheel Drive	104	03/13→04/14						
2.0 dCi All-wheel Drive	110	03/13→04/14						
1.6 dCi	96	03/13→04/14		für Linkslenker		24.4123-1725.3	011073	Ø 23,8 ohne Bremsflüssigkeitsbehälter
1.6 dCi All-wheel Drive	96	03/13→04/14						
NISSAN - QASHQAI II SUV (J11, J11_) 11/13→								
 Hauptbremszylinder								
1.2 DIG-T	85	11/13→		02/14→; Schaltgetriebe 6 Gang		24.4123-1728.3	011089	Ø 23,8 ohne Bremsflüssigkeitsbehälter
1.6 dCi	96	11/13→						
1.3 DIG-T	103	08/18→				24.4123-1728.3	011089	Ø 23,8 ohne Bremsflüssigkeitsbehälter
1.6 DIG-T	120	10/14→						
1.7 dCi	110	01/19→						
1.3 DIG-T	118	08/18→		Schaltgetriebe 6 Gang		24.4123-1728.3	011089	Ø 23,8 ohne Bremsflüssigkeitsbehälter
1.5 dCi	85	06/18→						
1.7 dCi ALL MODE 4x4-i	110	01/19→						
2.0	103 - 106	06/14→						
1.5 dCi	81	11/13→		→ 01/14; + ESP; für Linkslenker		24.4123-1725.3	011073	Ø 23,8 ohne Bremsflüssigkeitsbehälter
				02/14→		24.4123-1728.3	011089	Ø 23,8 ohne Bremsflüssigkeitsbehälter
				→ 01/14; - ESP; für Linkslenker		24.4123-1729.3	011106	Ø 23,8 ohne Bremsflüssigkeitsbehälter
1.6 dCi ALL MODE 4x4-i	96	11/13→		02/14→		24.4123-1728.3	011089	Ø 23,8 ohne Bremsflüssigkeitsbehälter
NISSAN - QASHQAI II VAN (J11_) 11/13→								
 Hauptbremszylinder								
1.5 dCi	81	05/15→				24.4123-1728.3	011089	Ø 23,8 ohne Bremsflüssigkeitsbehälter
1.5 dCi	85	06/18→		Schaltgetriebe 6 Gang		24.4123-1728.3	011089	Ø 23,8 ohne Bremsflüssigkeitsbehälter
NISSAN - SENTRA VII (B17) 08/12→								
 Hauptbremszylinder								
1.6	86	08/14→		für Linkslenker; CVT-Automatikgetriebe (stufenlos)		24.4123-1727.3	011088	Ø 23,8 ohne Bremsflüssigkeitsbehälter
1.8	96	08/12→						
NISSAN - TIIDA Schrägheck (C12) 08/10→								
 Hauptbremszylinder								
1.6	85 - 140	08/12→		für Linkslenker; CVT-Automatikgetriebe (stufenlos)		24.4123-1727.3	011088	Ø 23,8 ohne Bremsflüssigkeitsbehälter
1.6 CVT	80	01/14→						
1.8	96	08/12→						













	kw					! #		
NISSAN - X-TRAIL I (T30) 01/01→12/13								
 Hauptbremszylinder								
2.0	103 - 110	07/01→01/13		→ 08/03; Schaltgetriebe; - ESP		24.2125-1741.3	010988	Ø 25,4 ohne Bremsflüssigkeitsbehälter
2.0 4x4	103 - 206	06/01→01/13						
2.5 4x4	121	09/02→01/13						
2.2 DCi FWD	84	06/01→09/04		Schaltgetriebe; - ESP		24.2125-1741.3	010988	Ø 25,4 ohne Bremsflüssigkeitsbehälter
2.2 Di 4x4	84	07/01→10/05						
2.5 4x4	132	11/02→01/13						
2.5 4x4	134	09/01→02/07		→ 09/03; für Linkslenker; Schaltgetriebe; - ESP		24.2125-1741.3	010988	Ø 25,4 ohne Bremsflüssigkeitsbehälter
NISSAN - X-TRAIL III (T32_, T32R, T32RR) 10/13→								
 Hauptbremszylinder								
1.6 dCi	96	04/14→		→ 10/16; für Linkslenker; Automatikgetriebe		24.4123-1728.3	011089	Ø 23,8 ohne Bremsflüssigkeitsbehälter
				für Linkslenker; Schaltgetriebe 6 Gang		24.4123-1728.3	011089	Ø 23,8 ohne Bremsflüssigkeitsbehälter
1.6 dCi ALL MODE 4x4-i	96	04/14→		→ 08/16; für Linkslenker; für Modellreihenbaumuster: T32R/T32RR		24.4123-1728.3	011089	Ø 23,8 ohne Bremsflüssigkeitsbehälter
1.6 DIG-T	120	06/15→				24.4123-1728.3	011089	Ø 23,8 ohne Bremsflüssigkeitsbehälter
2.0	104 - 108	12/13→		12/14→; für Linkslenker; Schaltgetriebe		24.4123-1728.3	011089	Ø 23,8 ohne Bremsflüssigkeitsbehälter
2.0 Flexfuel	106	09/14→						
2.0 Flexfuel ALL MODE 4x4-i	106	02/14→						
2.5 ALL MODE 4x4-i	124	10/14→						
2.5 Flexfuel ALL MODE 4x4-i	126	02/14→						
2.0 dCi ALL MODE 4x4-i	130	10/16→		für Linkslenker; Schaltgetriebe 6 Gang		24.4123-1728.3	011089	Ø 23,8 ohne Bremsflüssigkeitsbehälter
2.5	124	01/15→		für Linkslenker; Schaltgetriebe		24.4123-1728.3	011089	Ø 23,8 ohne Bremsflüssigkeitsbehälter
NISSAN - X-TRAIL VAN (T32) 10/13→								
 Hauptbremszylinder								
dCi	96	04/14→		→ 10/16; für Linkslenker; Automatikgetriebe		24.4123-1728.3	011089	Ø 23,8 ohne Bremsflüssigkeitsbehälter
				für Linkslenker; Schaltgetriebe 6 Gang		24.4123-1728.3	011089	Ø 23,8 ohne Bremsflüssigkeitsbehälter
dCi 4x4	96	04/14→		→ 08/16; für Linkslenker; für Modellreihenbaumuster: T32R/T32RR		24.4123-1728.3	011089	Ø 23,8 ohne Bremsflüssigkeitsbehälter
OPEL - ADAM (M13) 10/12→02/19								
 Hauptbremszylinder								
1.0	66 - 85	07/14→11/18		für Linkslenker; Scheibenbremse		24.4123-1722.3	011071	Ø 23,8 ohne Bremsflüssigkeitsbehälter
1.4 LPG	64	07/13→11/18						
1.4 S	110	11/14→01/19						
1.2	51	10/12→02/19		01/13→; für Linkslenker; Scheibenbremse		24.4123-1722.3	011071	Ø 23,8 ohne Bremsflüssigkeitsbehälter
1.4	64 - 74	10/12→02/19						
OPEL - AGILA (A) (H00) 09/00→12/07								
 Hauptbremszylinder								
1.0	44	08/03→12/07		+ ABS; → 07/07		24.2120-1730.3	010678	Ø 20,6
1.0 12V	43	09/00→12/07						
1.2 16V	55	09/00→12/07						
1.3 CDTI	51	08/03→12/07						
OPEL - AGILA (B) (H08) 04/08→10/14								
 Hauptbremszylinder								
1.0	48 - 50	04/08→07/14		für Linkslenker; - ESP		24.4122-1718.3	011019	BOS Ø 22,2 ohne Bremsflüssigkeitsbehälter
1.0 LPG	48	01/10→06/11						
1.2	63 - 69	04/08→10/14		für Linkslenker; + ESP		24.4122-1719.3	011020	Ø 22,2 ohne Bremsflüssigkeitsbehälter
1.2 LPG	63	04/08→10/10						
1.3 CDTI	55	04/08→04/10						

	kw				! #		
OPEL - ASTRA F Cabriolet (T92) 03/93→03/01							
 Hauptbremszylinder							
1.4 i 16V 1.4 Si	66 60	01/96→03/01 05/93→03/01		→ 09/98; - ABS; für Fahrzeuge mit verstärkter Bremse		03.2122-0264.3 010129	ATE Ø 22,2
				→ 09/98; - ABS; nicht für Fahrzeuge mit verstärkter Bremse		24.2120-0702.3 010361	nicht für Delco Ø 20,6
1.8 i 16V	85	11/94→03/01		→ 09/98; - ABS		03.2122-0264.3 010129	ATE Ø 22,2
 Bremskraftregler							
1.6 i	55	01/96→03/01		→ R2500000		03.0101-0027.2 320022	ATE Satz 3/45 2x
OPEL - ASTRA F CLASSIC Caravan (T92) 01/98→01/05							
 Hauptbremszylinder							
1.4 i 1.6 i	44 55	01/98→01/05 01/98→01/05				24.2120-0702.3 010361	nicht für Delco Ø 20,6
OPEL - ASTRA F CLASSIC CC (T92) 01/98→08/02							
 Hauptbremszylinder							
1.4 i 1.6 i	44 55	01/98→08/02 01/98→08/02		- ABS		24.2120-0702.3 010361	nicht für Delco Ø 20,6
 Bremskraftregler							
1.6 i 16V	74	01/98→08/02				03.6583-0054.3 320146	ATE lastabhängig 8/3 4x
OPEL - ASTRA F CLASSIC Stufenheck (T92) 01/98→08/02							
 Hauptbremszylinder							
1.4 i 1.6 i	44 55	01/98→08/02 01/98→08/02		- ABS		24.2120-0702.3 010361	nicht für Delco Ø 20,6
 Bremskraftregler							
1.6 i 16V	74	01/98→08/02				03.6583-0054.3 320146	ATE lastabhängig 8/3 4x
OPEL - ASTRA F Kasten/Kombi (T92) 10/91→01/99							
 Hauptbremszylinder							
1.7 D	44	07/92→01/99		→ 09/98; - ABS; für Fahrzeuge mit verstärkter Bremse		03.2122-0264.3 010129	ATE Ø 22,2
				→ 09/98; - ABS; nicht für Fahrzeuge mit verstärkter Bremse		24.2120-0702.3 010361	nicht für Delco Ø 20,6
1.7 TD	50	08/94→01/99		→ 09/98; - ABS		24.2120-0702.3 010361	nicht für Delco Ø 20,6
OPEL - ASTRA G Cabriolet (T98) 03/01→10/05							
 Hauptbremszylinder							
1.6 1.6 16V 1.8 16V 2.0 16V Turbo 2.0 OPC 2.2 16V 2.2 DTI	76 74 92 147 141 108 92	01/03→10/05 03/01→10/05 03/01→10/05 11/02→10/05 03/02→10/05 03/01→10/05 09/02→10/05		- ESP + ESP - ESP		24.2123-1734.3 010640 24.2123-1739.3 010661 24.2123-1734.3 010640	TRW Ø 23,8 Ø 23,8 TRW Ø 23,8
OPEL - ASTRA G Caravan (T98) 02/98→07/04							
 Hauptbremszylinder							
1.2 16V 1.6 1.6 16V	48 55 74	02/98→09/00 02/98→09/00 02/98→07/04		04/98→; - ESP; für Fahrzeuge mit Scheibenbremse an der Hinterachse		24.2123-1734.3 010640	TRW Ø 23,8
				22000001→; - ESP; für Fahrzeuge mit Trommelbremse an der Hinterachse		24.2123-1734.3 010640	TRW Ø 23,8
				04/98→; + ESP		24.2123-1739.3 010661	Ø 23,8
1.2 16V 1.4 16V 1.4 LPG 1.6	55 66 66 62	09/00→07/04 06/98→07/04 03/98→07/04 09/00→07/04		- ESP; für Fahrzeuge mit Scheibenbremse an der Hinterachse		24.2123-1734.3 010640	TRW Ø 23,8
				22000001→; - ESP; für Fahrzeuge mit Trommelbremse an der Hinterachse		24.2123-1734.3 010640	TRW Ø 23,8
1.6 LPG	76 74	03/98→07/04		+ ESP		24.2123-1739.3 010661	Ø 23,8
1.7 DTI 16V	55	02/00→07/04					
1.6 CNG 1.8 16V 2.0 DTI 16V 2.0 OPC	71 92 74 141	03/03→07/04 09/00→07/04 08/99→07/04 09/02→07/04		- ESP + ESP		24.2123-1734.3 010640 24.2123-1739.3 010661	TRW Ø 23,8 Ø 23,8
2.2 16V 2.2 DTI	108 86	03/01→07/04 09/02→07/04					
→							

	kw					! #		
OPEL - ASTRA G Caravan (T98) 02/98→07/04								
 Hauptbremszylinder								
1.7 CDTI	59	04/03→05/04		- ESP		24.2123-1734.3	010640	TRW Ø 23,8
1.7 TD	50	02/98→08/00		04/98→; - ESP; für Fahrzeuge mit Scheibenbremse an der Hinterachse		24.2123-1734.3	010640	TRW Ø 23,8
				04/98→; + ESP		24.2123-1739.3	010661	Ø 23,8
1.8 16V	85	02/98→09/00		04/98→; - ESP		24.2123-1734.3	010640	TRW Ø 23,8
2.0 16V	100	02/98→07/04		04/98→; + ESP		24.2123-1739.3	010661	Ø 23,8
2.0 DI	60	02/98→07/04						
 Bremskraftregler								
1.2 16V	48	02/98→09/00		04/98→; - ABS		03.6583-0073.3	320234	ATE lastabhängig 8/3 4x
1.6	55	02/98→09/00						
1.6 16V	74	02/98→07/04						
1.7 TD	50	02/98→08/00						
1.8 16V	85	02/98→09/00						
2.0 16V	100	02/98→07/04						
1.2 16V	55	09/00→07/04		- ABS		03.6583-0073.3	320234	ATE lastabhängig 8/3 4x
1.4 16V	66	06/98→07/04						
1.4 LPG	66	03/98→07/04						
1.6	62 -	09/00→07/04						
	76							
1.6 CNG	71	03/03→07/04						
1.6 LPG	74 -	03/98→07/04						
	76							
1.7 CDTI	59	04/03→05/04						
1.7 DTI 16V	55	02/00→07/04						
1.8 16V	92	09/00→07/04						
OPEL - ASTRA G CC (T98) 02/98→12/09								
 Hauptbremszylinder								
1.2 16V	48	02/98→09/00		04/98→; - ESP; für Fahrzeuge mit Scheibenbremse an der Hinterachse		24.2123-1734.3	010640	TRW Ø 23,8
1.4 16V	66	02/98→01/05						
1.4 LPG	66	02/98→01/05		22000001→; - ESP; für Fahrzeuge mit Trommelbremse an der Hinterachse		24.2123-1734.3	010640	TRW Ø 23,8
1.6	55	02/98→09/00						
1.6 16V	74	02/98→01/05		04/98→; + ESP		24.2123-1739.3	010661	Ø 23,8
1.6 LPG	74	03/98→01/05						
1.2 16V	55	09/00→01/05		- ESP; für Fahrzeuge mit Scheibenbremse an der Hinterachse		24.2123-1734.3	010640	TRW Ø 23,8
1.4	66	09/07→12/09						
1.6	62 -	09/00→01/05		22000001→; - ESP; für Fahrzeuge mit Trommelbremse an der Hinterachse		24.2123-1734.3	010640	TRW Ø 23,8
	76							
1.6 LPG	76	11/02→06/07		+ ESP		24.2123-1739.3	010661	Ø 23,8
1.7 DTI 16V	55	02/00→01/05						
1.7 CDTI	59	04/03→01/05		- ESP		24.2123-1734.3	010640	TRW Ø 23,8
1.7 TD	50	02/98→08/00		04/98→; - ESP; für Fahrzeuge mit Scheibenbremse an der Hinterachse		24.2123-1734.3	010640	TRW Ø 23,8
				04/98→; + ESP		24.2123-1739.3	010661	Ø 23,8
1.8	81	02/03→01/04		- ESP		24.2123-1734.3	010640	TRW Ø 23,8
1.8 16V	92	09/00→01/05						
2.0 16V OPC	118	11/99→09/02		+ ESP		24.2123-1739.3	010661	Ø 23,8
2.0 DTI 16V	74	08/99→01/05						
2.0 OPC	141 -	09/02→01/05						
	147							
2.2 DTI	86 -	09/02→01/05						
	92							
1.8 16V	85	02/98→09/00		04/98→; - ESP		24.2123-1734.3	010640	TRW Ø 23,8
2.0 16V	100	02/98→01/05		04/98→; + ESP		24.2123-1739.3	010661	Ø 23,8
2.0 DI	60	02/98→01/05						
2.2 16V	108	06/00→01/05		09/00→; - ESP		24.2123-1734.3	010640	TRW Ø 23,8
				09/00→; + ESP		24.2123-1739.3	010661	Ø 23,8
 Bremskraftregler								
1.2 16V	48	02/98→09/00		04/98→; - ABS		03.6583-0073.3	320234	ATE lastabhängig 8/3 4x
1.2 16V	55	09/00→01/05		- ABS		03.6583-0073.3	320234	ATE lastabhängig 8/3 4x
OPEL - ASTRA G CLASSIC (T98) 03/04→07/09								
 Hauptbremszylinder								
1.4 16V	66	05/04→07/09		- ESP; für Fahrzeuge mit Scheibenbremse an der Hinterachse		24.2123-1734.3	010640	TRW Ø 23,8
1.6	76	03/06→06/08						
1.6 16V	74	05/04→02/06		22000001→; - ESP; für Fahrzeuge mit Trommelbremse an der Hinterachse		24.2123-1734.3	010640	TRW Ø 23,8
				+ ESP		24.2123-1739.3	010661	Ø 23,8
1.7 CDTI	59	06/04→07/09		- ESP		24.2123-1734.3	010640	TRW Ø 23,8

	kw					! #		
OPEL - ASTRA G CLASSIC Caravan (F35) 03/04→07/09								
 Hauptbremszylinder								
1.4	66	10/07→07/09		- ESP		24.2123-1734.3	010640	TRW Ø 23,8
1.4 16V	66	07/04→09/07		+ ESP		24.2123-1739.3	010661	Ø 23,8
1.6	74 - 76	06/04→07/09		- ESP; für Fahrzeuge mit Scheibenbremse an der Hinterachse		24.2123-1734.3	010640	TRW Ø 23,8
				22000001→; - ESP; für Fahrzeuge mit Trommelbremse an der Hinterachse		24.2123-1734.3	010640	TRW Ø 23,8
				+ ESP		24.2123-1739.3	010661	Ø 23,8
1.7 CDTI	59	05/04→07/09		- ESP		24.2123-1734.3	010640	TRW Ø 23,8
 Bremskraftregler								
1.4	66	10/07→07/09		- ABS		03.6583-0073.3	320234	ATE lastabhängig 8/3 4x
1.4 16V	66	07/04→09/07						
1.6	74	06/04→07/09						
	76							
1.7 CDTI	59	05/04→07/09						
OPEL - ASTRA G CLASSIC Stufenheck (T98) 03/04→07/09								
 Hauptbremszylinder								
1.4 16V	66	05/04→07/09		- ESP		24.2123-1734.3	010640	TRW Ø 23,8
				+ ESP		24.2123-1739.3	010661	Ø 23,8
1.6 16V	74	03/04→01/08		- ESP; für Fahrzeuge mit Scheibenbremse an der Hinterachse		24.2123-1734.3	010640	TRW Ø 23,8
				22000001→; - ESP; für Fahrzeuge mit Trommelbremse an der Hinterachse		24.2123-1734.3	010640	TRW Ø 23,8
				+ ESP		24.2123-1739.3	010661	Ø 23,8
OPEL - ASTRA G Coupe (T98) 03/00→05/05								
 Hauptbremszylinder								
1.6 16V	74 - 76	03/00→05/05		- ESP; für Fahrzeuge mit Scheibenbremse an der Hinterachse		24.2123-1734.3	010640	TRW Ø 23,8
				22000001→; - ESP; für Fahrzeuge mit Trommelbremse an der Hinterachse		24.2123-1734.3	010640	TRW Ø 23,8
				+ ESP		24.2123-1739.3	010661	Ø 23,8
1.8 16V	85 - 92	03/00→05/05		- ESP		24.2123-1734.3	010640	TRW Ø 23,8
2.0 16V Turbo	140 - 147	09/00→05/05		+ ESP		24.2123-1739.3	010661	Ø 23,8
2.2 16V	108	09/00→05/05						
2.2 DTI	92	09/02→05/05						
OPEL - ASTRA G Kasten/Kombi (F70) 09/98→04/05								
 Hauptbremszylinder								
1.2	48	09/98→08/00		- ESP; für Fahrzeuge mit Scheibenbremse an der Hinterachse		24.2123-1734.3	010640	TRW Ø 23,8
1.4	66	09/98→04/05						
1.6	55 - 76	09/98→04/05		22000001→; - ESP; für Fahrzeuge mit Trommelbremse an der Hinterachse		24.2123-1734.3	010640	TRW Ø 23,8
				+ ESP		24.2123-1739.3	010661	Ø 23,8
1.7 CDTI	59	07/03→11/04						
1.7 DTI 16V	55	02/00→04/05						
1.7 TD	50	01/99→04/05		- ESP; für Fahrzeuge mit Scheibenbremse an der Hinterachse		24.2123-1734.3	010640	TRW Ø 23,8
				+ ESP		24.2123-1739.3	010661	Ø 23,8
2.0 DI	60	01/99→04/05		- ESP		24.2123-1734.3	010640	TRW Ø 23,8
2.0 DTI	74	09/00→04/05		+ ESP		24.2123-1739.3	010661	Ø 23,8
 Bremskraftregler								
1.2	48	09/98→08/00		- ABS		03.6583-0073.3	320234	ATE lastabhängig 8/3 4x
1.4	66	09/98→04/05						
1.6	55 - 76	09/98→04/05						
1.7 TD	50	01/99→04/05						
OPEL - ASTRA G Stufenheck (T98) 03/98→12/09								
 Hauptbremszylinder								
1.2 16V	48 - 55	09/98→01/05		- ESP; für Fahrzeuge mit Scheibenbremse an der Hinterachse		24.2123-1734.3	010640	TRW Ø 23,8
1.4 16V	66	09/98→01/05						
1.4 LPG	66	03/98→01/05		22000001→; - ESP; für Fahrzeuge mit Trommelbremse an der Hinterachse		24.2123-1734.3	010640	TRW Ø 23,8
1.6	55 - 76	09/98→12/09		+ ESP		24.2123-1739.3	010661	Ø 23,8
1.6 16V	74	09/98→01/05						
1.6 LPG	55 - 74	10/98→01/05						



	kw			 	! #		
OPEL - ASTRA G Stufenheck (T98) 03/98→12/09							
 Hauptbremszylinder							
1.7 DTI 16V	55	02/00→01/05		- ESP; für Fahrzeuge mit Scheibenbremse an der Hinterachse		24.2123-1734.3 010640	TRW Ø 23,8
				22000001→; - ESP; für Fahrzeuge mit Trommelbremse an der Hinterachse		24.2123-1734.3 010640	TRW Ø 23,8
				+ ESP		24.2123-1739.3 010661	Ø 23,8
1.4	66	09/07→12/09		- ESP		24.2123-1734.3 010640	TRW Ø 23,8
1.8 16V	85 - 92	09/98→01/05		+ ESP		24.2123-1739.3 010661	Ø 23,8
2.0 16V	100	09/98→01/05					
2.0 DI	60	09/98→01/05					
2.0 DTI 16V	74	08/99→01/05					
2.2 16V	108	03/01→01/05					
2.2 DTI	86 - 92	09/02→01/05					
1.7 CDTI	59	04/03→12/09		- ESP		24.2123-1734.3 010640	TRW Ø 23,8
1.7 TD	50	09/98→08/00		- ESP; für Fahrzeuge mit Scheibenbremse an der Hinterachse		24.2123-1734.3 010640	TRW Ø 23,8
				+ ESP		24.2123-1739.3 010661	Ø 23,8
 Bremskraftregler							
1.2 16V	48 - 55	09/98→01/05		- ABS		03.6583-0073.3 320234	ATE lastabhängig 8/3 4x
OPEL - ASTRA H (A04) 01/04→05/14							
 Bremskraftverstärker							
1.9 CDTI	74 - 110	09/04→10/10		für Linkslenker		03.7863-7803.4 300237	ATE Ø 10" pneumatisch
1.9 CDTI	88	06/04→10/10		09/04→; für Linkslenker		03.7863-7803.4 300237	ATE Ø 10" pneumatisch
1.9 CDTI 16V	88	04/04→10/10					
 Hauptbremszylinder							
1.2	59	08/05→10/10		für Rechtslenker; → 68999999		24.2125-1736.3 010904	TRW Ø 25,4
1.3 CDTI	66	08/05→10/10		für Linkslenker; → 68999999; + ESP		24.2125-1736.3 010904	TRW Ø 25,4
1.4	55 - 66	03/04→10/10		für Linkslenker; → 68999999; - ESP		24.2125-1737.3 010906	TRW Ø 25,4
1.4 LPG	66	08/09→10/10		72000001→; für Rechtslenker		24.4125-1703.3 010907	TRW Ø 25,4
1.6	77	03/04→10/10		72000001→; für Rechtslenker; + ESP		24.4125-1703.3 010907	TRW Ø 25,4
1.6 Turbo	132	02/07→10/10		72000001→; für Linkslenker; - ESP		24.4125-1704.3 010908	TRW Ø 25,4
1.7 CDTI	59 - 74	03/04→10/10		72000001→; für Linkslenker; - ESP		24.4125-1704.3 010908	TRW Ø 25,4
1.8	92 - 103	01/04→10/10					
2.0 Turbo	125 - 177	03/04→10/10					
1.6	85	12/06→05/14		01/07→; → 68999999; für Rechtslenker		24.2125-1736.3 010904	TRW Ø 25,4
				01/07→; → 68999999; für Linkslenker; + ESP		24.2125-1736.3 010904	TRW Ø 25,4
				01/07→; → 68999999; für Linkslenker; - ESP		24.2125-1737.3 010906	TRW Ø 25,4
				72000001→; → 11/10; für Rechtslenker		24.4125-1703.3 010907	TRW Ø 25,4
				72000001→; → 11/10; für Linkslenker; + ESP		24.4125-1703.3 010907	TRW Ø 25,4
				72000001→; → 11/10; für Linkslenker; - ESP		24.4125-1704.3 010908	TRW Ø 25,4
1.7 CDTI	81 - 92	02/07→05/14		04/07→; → 68999999; für Rechtslenker		24.2125-1736.3 010904	TRW Ø 25,4
				04/07→; → 68999999; für Linkslenker; + ESP		24.2125-1736.3 010904	TRW Ø 25,4
				04/07→; → 68999999; für Linkslenker; - ESP		24.2125-1737.3 010906	TRW Ø 25,4
				72000001→; → 11/10; für Rechtslenker		24.4125-1703.3 010907	TRW Ø 25,4
				72000001→; → 11/10; für Linkslenker; + ESP		24.4125-1703.3 010907	TRW Ø 25,4
				72000001→; → 11/10; für Linkslenker; - ESP		24.4125-1704.3 010908	TRW Ø 25,4
1.9 CDTI	74 - 110	09/04→10/10				03.4155-0156.3 010862	ATE Ø 25,4
1.9 CDTI	88	06/04→10/10		09/04→		03.4155-0156.3 010862	ATE Ø 25,4
1.9 CDTI 16V	88	04/04→10/10					
OPEL - ASTRA H Caravan (A04) 08/04→05/14							
 Bremskraftverstärker							
1.9 CDTI	74 - 110	09/04→10/10		für Linkslenker		03.7863-7803.4 300237	ATE Ø 10" pneumatisch
1.9 CDTI 16V →	88	08/04→10/10					

OPEL - ASTRA H Caravan (A04) 08/04→05/14

Hauptbremszylinder

1.3 CDTI 1.4	66 55 - 66	08/05→10/10 08/04→10/10	72000001→; für Linkslenker; + ESP	24.2125-1703.3 010483	Ø 25,4
	66		72000001→; für Linkslenker; - ESP	24.2125-1704.3 010446	TRW Ø 25,4
1.4 LPG	66	08/09→10/10	→ 62999999; für Rechtslenker	24.2125-1736.3 010904	TRW Ø 25,4
1.6	77	08/04→10/10	→ 68999999; für Linkslenker; + ESP	24.2125-1736.3 010904	TRW Ø 25,4
1.6 LPG	85	08/09→10/10	→ 68999999; für Linkslenker; - ESP	24.2125-1737.3 010906	TRW Ø 25,4
1.6 Turbo	132	02/07→10/10			
1.7 CDTI	59 - 74	08/04→10/10	72000001→; für Rechtslenker	24.4125-1703.3 010907	TRW Ø 25,4
1.8	92 - 103	08/04→05/14			
2.0 Turbo	125 - 147	08/04→10/10			
1.6	85	12/06→05/14	72000001→; → 11/10; für Linkslenker; + ESP	24.2125-1703.3 010483	Ø 25,4
			72000001→; → 11/10; für Linkslenker; - ESP	24.2125-1704.3 010446	TRW Ø 25,4
			01/07→; → 62999999; für Rechtslenker	24.2125-1736.3 010904	TRW Ø 25,4
			01/07→; → 68999999; für Linkslenker; + ESP	24.2125-1736.3 010904	TRW Ø 25,4
			01/07→; → 68999999; für Linkslenker; - ESP	24.2125-1737.3 010906	TRW Ø 25,4
			72000001→; → 11/10; für Rechtslenker	24.4125-1703.3 010907	TRW Ø 25,4
1.7 CDTI	81 - 92	02/07→05/14	72000001→; → 11/10; für Linkslenker; + ESP	24.2125-1703.3 010483	Ø 25,4
			72000001→; → 11/10; für Linkslenker; - ESP	24.2125-1704.3 010446	TRW Ø 25,4
			04/07→; → 62999999; für Rechtslenker	24.2125-1736.3 010904	TRW Ø 25,4
			04/07→; → 68999999; für Linkslenker; + ESP	24.2125-1736.3 010904	TRW Ø 25,4
			04/07→; → 68999999; für Linkslenker; - ESP	24.2125-1737.3 010906	TRW Ø 25,4
			72000001→; → 11/10; für Rechtslenker	24.4125-1703.3 010907	TRW Ø 25,4
1.9 CDTI	74 - 110	09/04→10/10		03.4155-0156.3 010862	ATE Ø 25,4
1.9 CDTI 16V	88	08/04→10/10			

OPEL - ASTRA H CLASSIC Kombi (A04) 12/06→











Hauptbremszylinder

1.4 1.7 CDTi 1.7 CDTI 1.8	66 81 92 103	01/09→ 01/09→ 01/09→ 01/12→05/14	72000001→; für Linkslenker; + ESP	24.2125-1703.3 010483	Ø 25,4
			72000001→; für Linkslenker; - ESP	24.2125-1704.3 010446	TRW Ø 25,4
			→ 62999999; für Rechtslenker	24.2125-1736.3 010904	TRW Ø 25,4
			→ 68999999; für Linkslenker; + ESP	24.2125-1736.3 010904	TRW Ø 25,4
			→ 68999999; für Linkslenker; - ESP	24.2125-1737.3 010906	TRW Ø 25,4
			72000001→; für Rechtslenker	24.4125-1703.3 010907	TRW Ø 25,4
1.6	85	12/06→05/14	72000001→; → 11/10; für Linkslenker; + ESP	24.2125-1703.3 010483	Ø 25,4
			72000001→; → 11/10; für Linkslenker; - ESP	24.2125-1704.3 010446	TRW Ø 25,4
			01/07→; → 62999999; für Rechtslenker	24.2125-1736.3 010904	TRW Ø 25,4
			01/07→; → 68999999; für Linkslenker; + ESP	24.2125-1736.3 010904	TRW Ø 25,4
			01/07→; → 68999999; für Linkslenker; - ESP	24.2125-1737.3 010906	TRW Ø 25,4
			72000001→; → 11/10; für Rechtslenker	24.4125-1703.3 010907	TRW Ø 25,4











OPEL - ASTRA H CLASSIC Schrägheck (A04) 01/09→













Hauptbremszylinder











1.3 CDTI 1.6 1.7 CDTI	66 85 81	01/09→ 01/09→ 01/09→	für Rechtslenker; → 68999999	24.2125-1736.3 010904	TRW Ø 25,4
			für Linkslenker; → 68999999; + ESP	24.2125-1736.3 010904	TRW Ø 25,4
			für Linkslenker; → 68999999; - ESP	24.2125-1737.3 010906	TRW Ø 25,4
			72000001→; → 11/10; für Rechtslenker	24.4125-1703.3 010907	TRW Ø 25,4
			72000001→; → 11/10; für Linkslenker; + ESP	24.4125-1703.3 010907	TRW Ø 25,4
			72000001→; → 11/10; für Linkslenker; - ESP	24.4125-1704.3 010908	TRW Ø 25,4
1.4 1.7 CDTI 1.8	66 92 103	01/09→ 01/09→ 02/13→	für Rechtslenker; → 68999999	24.2125-1736.3 010904	TRW Ø 25,4
			für Linkslenker; → 68999999; + ESP	24.2125-1736.3 010904	TRW Ø 25,4
			für Linkslenker; → 68999999; - ESP	24.2125-1737.3 010906	TRW Ø 25,4
			72000001→; für Rechtslenker	24.4125-1703.3 010907	TRW Ø 25,4
→					















	kw					! #		
OPEL - ASTRA H CLASSIC Schrägheck (A04) 01/09→								
 Hauptbremszylinder								
1.4 1.7 CDTi 1.8	66 92 103	01/09→ 01/09→ 02/13→		72000001→; für Linkslenker; + ESP 72000001→; für Linkslenker; - ESP		24.4125-1703.3 24.4125-1704.3	010907 010908	TRW Ø 25,4 TRW Ø 25,4
OPEL - ASTRA H CLASSIC Stufenheck (A04) 02/07→								
 Hauptbremszylinder								
1.6	85	01/09→05/14		→ 68999999; für Rechtslenker → 68999999; für Linkslenker; + ESP → 68999999; für Linkslenker; - ESP 72000001→; → 11/10; für Rechtslenker 72000001→; für Linkslenker; + ESP 72000001→; für Linkslenker; - ESP		24.2125-1736.3 24.2125-1736.3 24.2125-1737.3 24.4125-1703.3 24.4125-1703.3 24.4125-1704.3	010904 010904 010906 010907 010907 010908	TRW Ø 25,4 TRW Ø 25,4 TRW Ø 25,4 TRW Ø 25,4 TRW Ø 25,4 TRW Ø 25,4
1.7 CDTi 1.7 CDTi 1.8	81 92 103	01/09→ 01/09→ 02/07→09/12		→ 68999999; für Rechtslenker → 68999999; für Linkslenker; + ESP → 68999999; für Linkslenker; - ESP 72000001→; für Rechtslenker 72000001→; für Linkslenker; + ESP 72000001→; für Linkslenker; - ESP		24.2125-1736.3 24.2125-1736.3 24.2125-1737.3 24.4125-1703.3 24.4125-1703.3 24.4125-1704.3	010904 010904 010906 010907 010907 010908	TRW Ø 25,4 TRW Ø 25,4 TRW Ø 25,4 TRW Ø 25,4 TRW Ø 25,4 TRW Ø 25,4
OPEL - ASTRA H GTC (A04) 03/05→10/10								
 Bremskraftverstärker								
1.9 CDTi 1.9 CDTi 1.9 CDTi 16V	110 74 - 88 88	03/05→10/10 09/05→10/10 03/05→10/10		für Linkslenker		03.7863-7803.4	300237	ATE Ø 10" pneumatisch
 Hauptbremszylinder								
1.3 CDTi	66	04/05→10/10		08/05→; → 68999999; für Linkslenker; + ESP 08/05→; → 68999999; für Rechtslenker 08/05→; → 68999999; für Linkslenker; - ESP 72000001→; für Rechtslenker 72000001→; für Linkslenker; + ESP 72000001→; für Linkslenker; - ESP		24.2125-1736.3 24.2125-1736.3 24.2125-1737.3 24.4125-1703.3 24.4125-1703.3 24.4125-1704.3	010904 010904 010906 010907 010907 010908	TRW Ø 25,4 TRW Ø 25,4 TRW Ø 25,4 TRW Ø 25,4 TRW Ø 25,4 TRW Ø 25,4
1.4 1.6 1.6 Turbo 1.7 CDTi 1.7 CDTi 1.8 2.0 Turbo	55 - 66 77 132 74 59 92 - 103 125 - 177	03/05→10/10 03/05→10/10 02/07→10/10 03/05→10/10 03/05→10/10 03/05→10/10 03/05→10/10		für Rechtslenker; → 68999999 für Linkslenker; → 68999999; + ESP für Linkslenker; → 68999999; - ESP 72000001→; für Rechtslenker 72000001→; für Linkslenker; + ESP 72000001→; für Linkslenker; - ESP		24.2125-1736.3 24.2125-1736.3 24.2125-1737.3 24.4125-1703.3 24.4125-1703.3 24.4125-1704.3	010904 010904 010906 010907 010907 010908	TRW Ø 25,4 TRW Ø 25,4 TRW Ø 25,4 TRW Ø 25,4 TRW Ø 25,4 TRW Ø 25,4
1.6	85	12/06→10/10		01/07→; → 68999999; für Linkslenker; + ESP 01/07→; → 68999999; für Rechtslenker 01/07→; → 68999999; für Linkslenker; - ESP 72000001→; für Rechtslenker 72000001→; für Linkslenker; + ESP 72000001→; für Linkslenker; - ESP		24.2125-1736.3 24.2125-1736.3 24.2125-1737.3 24.4125-1703.3 24.4125-1703.3 24.4125-1704.3	010904 010904 010906 010907 010907 010908	TRW Ø 25,4 TRW Ø 25,4 TRW Ø 25,4 TRW Ø 25,4 TRW Ø 25,4 TRW Ø 25,4
1.7 CDTi	81 - 92	02/07→10/10		04/07→; → 68999999; für Linkslenker; + ESP 04/07→; → 68999999; für Rechtslenker 04/07→; → 68999999; für Linkslenker; - ESP 72000001→; für Rechtslenker 72000001→; für Linkslenker; + ESP 72000001→; für Linkslenker; - ESP		24.2125-1736.3 24.2125-1736.3 24.2125-1737.3 24.4125-1703.3 24.4125-1703.3 24.4125-1704.3	010904 010904 010906 010907 010907 010908	TRW Ø 25,4 TRW Ø 25,4 TRW Ø 25,4 TRW Ø 25,4 TRW Ø 25,4 TRW Ø 25,4
1.9 CDTi 1.9 CDTi 1.9 CDTi 16V	110 74 - 88 88	03/05→10/10 09/05→10/10 03/05→10/10				03.4155-0156.3	010862	ATE Ø 25,4





























	kw					! #		
OPEL - ASTRA H Kasten/Kombi (L70) 02/04→10/14								
 Bremskraftverstärker								
1.9 CDTI	74 - 110	09/04→12/12		für Linkslenker		03.7863-7803.4	300237	ATE Ø 10" pneumatisch
1.9 CDTI 16V	88	08/04→10/10						
 Hauptbremszylinder								
1.3 CDTI 1.6 EcoTec	66 76 - 85	08/05→10/10 02/04→12/10		72000001→; für Linkslenker; + ESP	24.2125-1703.3	010483	Ø 25,4	
				72000001→; für Linkslenker; - ESP	24.2125-1704.3	010446	TRW Ø 25,4	
				→ 62999999; für Rechtslenker	24.2125-1736.3	010904	TRW Ø 25,4	
				→ 68999999; für Linkslenker; + ESP	24.2125-1736.3	010904	TRW Ø 25,4	
				→ 68999999; für Linkslenker; - ESP	24.2125-1737.3	010906	TRW Ø 25,4	
				72000001→; für Rechtslenker	24.4125-1703.3	010907	TRW Ø 25,4	
1.4 EcoTec 1.7 CDTI	66 59	12/04→12/12 12/04→07/07		für Rechtslenker; → 68999999	24.2125-1736.3	010904	TRW Ø 25,4	
				→ 68999999; für Linkslenker; + ESP	24.2125-1736.3	010904	TRW Ø 25,4	
				→ 68999999; für Linkslenker; - ESP	24.2125-1737.3	010906	TRW Ø 25,4	
				72000001→; für Rechtslenker	24.4125-1703.3	010907	TRW Ø 25,4	
				72000001→; für Linkslenker; + ESP	24.4125-1703.3	010907	TRW Ø 25,4	
1.7 CDTI	74	03/04→10/10		72000001→; für Linkslenker; + ESP	24.2125-1703.3	010483	Ø 25,4	
				72000001→; für Linkslenker; - ESP	24.2125-1704.3	010446	TRW Ø 25,4	
				08/04→; → 62999999; für Rechtslenker	24.2125-1736.3	010904	TRW Ø 25,4	
				08/04→; → 68999999; für Linkslenker; + ESP	24.2125-1736.3	010904	TRW Ø 25,4	
				08/04→; → 68999999; für Linkslenker; - ESP	24.2125-1737.3	010906	TRW Ø 25,4	
				72000001→; für Rechtslenker	24.4125-1703.3	010907	TRW Ø 25,4	
1.7 CDTI	81 - 92	02/07→10/14		72000001→; für Linkslenker; + ESP	24.2125-1703.3	010483	Ø 25,4	
				72000001→; für Linkslenker; - ESP	24.2125-1704.3	010446	TRW Ø 25,4	
				04/07→; → 62999999; für Rechtslenker	24.2125-1736.3	010904	TRW Ø 25,4	
				04/07→; → 68999999; für Linkslenker; + ESP	24.2125-1736.3	010904	TRW Ø 25,4	
				04/07→; → 68999999; für Linkslenker; - ESP	24.2125-1737.3	010906	TRW Ø 25,4	
				72000001→; für Rechtslenker	24.4125-1703.3	010907	TRW Ø 25,4	
1.9 CDTI	74 - 110	09/04→12/12			03.4155-0156.3	010862	ATE Ø 25,4	
1.9 CDTI 16V	88	08/04→10/10						
OPEL - ASTRA H Stufenheck (A04) 02/07→05/14								
 Hauptbremszylinder								
1.3 CDTi 1.4 1.6 1.7 CDTi 1.8	66 66 77 74 103	02/07→10/10 02/07→06/10 02/07→06/10 02/07→10/10 02/07→09/12		→ 68999999; für Rechtslenker	24.2125-1736.3	010904	TRW Ø 25,4	
				→ 68999999; für Linkslenker; + ESP	24.2125-1736.3	010904	TRW Ø 25,4	
				→ 68999999; für Linkslenker; - ESP	24.2125-1737.3	010906	TRW Ø 25,4	
				72000001→; für Rechtslenker	24.4125-1703.3	010907	TRW Ø 25,4	
				72000001→; für Linkslenker; + ESP	24.4125-1703.3	010907	TRW Ø 25,4	
				72000001→; für Linkslenker; - ESP	24.4125-1704.3	010908	TRW Ø 25,4	
1.6	85	02/07→05/14		→ 68999999; für Rechtslenker	24.2125-1736.3	010904	TRW Ø 25,4	
				→ 68999999; für Linkslenker; + ESP	24.2125-1736.3	010904	TRW Ø 25,4	
				→ 68999999; für Linkslenker; - ESP	24.2125-1737.3	010906	TRW Ø 25,4	
				72000001→; → 11/10; für Rechtslenker	24.4125-1703.3	010907	TRW Ø 25,4	
				72000001→; → 11/10; für Linkslenker; + ESP	24.4125-1703.3	010907	TRW Ø 25,4	
				72000001→; → 11/10; für Linkslenker; - ESP	24.4125-1704.3	010908	TRW Ø 25,4	
1.7 CDTi	81	02/07→05/14		04/07→; → 68999999; für Rechtslenker	24.2125-1736.3	010904	TRW Ø 25,4	
				04/07→; → 68999999; für Linkslenker; + ESP	24.2125-1736.3	010904	TRW Ø 25,4	
				04/07→; → 68999999; für Linkslenker; - ESP	24.2125-1737.3	010906	TRW Ø 25,4	
				72000001→; → 11/10; für Rechtslenker	24.4125-1703.3	010907	TRW Ø 25,4	
				72000001→; → 11/10; für Linkslenker; + ESP	24.4125-1703.3	010907	TRW Ø 25,4	
				72000001→; → 11/10; für Linkslenker; - ESP	24.4125-1704.3	010908	TRW Ø 25,4	













	kW					! #					
OPEL - ASTRA H TwinTop (A04) 09/05→10/10											
 Bremskraftverstärker											
1.9 CDTi	110	09/05→10/10		03/06→; für Linkslenker		03.7863-7803.4	300237	ATE Ø 10" pneumatisch			
 Hauptbremszylinder											
1.6	77	09/05→10/10		03/06→; → 68999999; für Linkslenker; + ESP		24.2125-1736.3	010904	TRW Ø 25,4			
1.8	92 - 103	09/05→10/10		03/06→; → 68999999; für Rechtslenker		24.2125-1736.3	010904	TRW Ø 25,4			
2.0 Turbo	125 - 147	09/05→10/10		03/06→; → 68999999; für Linkslenker; - ESP		24.2125-1737.3	010906	TRW Ø 25,4			
				03/06→; für Rechtslenker		24.4125-1703.3	010907	TRW Ø 25,4			
				72000001→; für Linkslenker; + ESP		24.4125-1703.3	010907	TRW Ø 25,4			
				72000001→; für Linkslenker; - ESP		24.4125-1704.3	010908	TRW Ø 25,4			
1.6 1.6 Turbo	85 132	12/06→10/10 02/07→10/10		→ 68999999; für Rechtslenker		24.2125-1736.3	010904	TRW Ø 25,4			
				→ 68999999; für Linkslenker; + ESP		24.2125-1736.3	010904	TRW Ø 25,4			
				→ 68999999; für Linkslenker; - ESP		24.2125-1737.3	010906	TRW Ø 25,4			
				für Rechtslenker		24.4125-1703.3	010907	TRW Ø 25,4			
				72000001→; für Linkslenker; + ESP		24.4125-1703.3	010907	TRW Ø 25,4			
				72000001→; für Linkslenker; - ESP		24.4125-1704.3	010908	TRW Ø 25,4			
1.9 CDTi	110	09/05→10/10		03/06→; für Rechtslenker		03.4155-0156.3	010862	ATE Ø 25,4			
				03/06→; für Linkslenker; + ESP		03.4155-0156.3	010862	ATE Ø 25,4			
OPEL - ASTRA J (P10) 09/09→10/15											
 Bremskraftverstärker											
1.3 CDTi 1.4	70 64 - 74	12/09→10/15 12/09→10/15		für Linkslenker		03.7858-0732.4	300272	ATE Ø 9 / 8" pneumatisch			
1.4 LPG 1.4 Turbo 1.6 1.6 CDTi	103 103 85 81 - 100	01/12→10/15 12/09→10/15 12/09→10/15 11/13→10/15									
1.6 SIDI 1.6 Turbo 1.6 Turbo 4x4 1.7 CDTi	125 132 132 81 - 96	12/12→10/15 12/09→10/15 12/09→10/15 09/09→10/15									
2.0 BiTurbo CDTi 2.0 CDTi	143 96 - 121	09/12→10/15 09/09→10/15									
1.4 Turbo	88	10/10→10/15		11/10→; für Linkslenker		03.7858-0732.4	300272	ATE Ø 9 / 8" pneumatisch			
 Hauptbremszylinder											
1.3 CDTi 1.4	70 64 - 74	12/09→10/15 12/09→10/15		für Linkslenker		03.2125-0421.3	010934	ATE Ø 25,4			
1.4 LPG 1.4 Turbo 1.6 1.6 CDTi 1.6 SIDI 1.6 Turbo 1.6 Turbo 4x4 1.7 CDTi 2.0 CDTi	103 103 85 81 125 132 132 92 - 96 96 - 121	01/12→10/15 12/09→10/15 12/09→10/15 02/14→10/15 12/12→10/15 12/09→10/15 12/09→10/15 12/09→10/15 06/11→10/15		für Rechtslenker		24.4155-0201.3	011125	ATE Ø 25,4 ohne Bremsflüssigkeitsbehälter			
			1.4 Turbo	88	10/10→10/15		11/10→; für Linkslenker		03.2125-0421.3	010934	ATE Ø 25,4
							11/10→; für Rechtslenker		24.4155-0201.3	011125	ATE Ø 25,4 ohne Bremsflüssigkeitsbehälter
			1.6 CDTi	100	11/13→10/15		für Linkslenker		03.2125-0421.3	010934	ATE Ø 25,4
							01/14→; für Rechtslenker		24.4155-0201.3	011125	ATE Ø 25,4 ohne Bremsflüssigkeitsbehälter
			1.7 CDTi 2.0 CDTi	81 118	09/09→10/15 09/09→10/15		für Linkslenker		03.2125-0421.3	010934	ATE Ø 25,4
							12/09→; für Rechtslenker		24.4155-0201.3	011125	ATE Ø 25,4 ohne Bremsflüssigkeitsbehälter
			2.0 BiTurbo CDTi	143	09/12→10/15		für Linkslenker		03.2125-0421.3	010934	ATE Ø 25,4
							12/12→; für Rechtslenker		24.4155-0201.3	011125	ATE Ø 25,4 ohne Bremsflüssigkeitsbehälter
			OPEL - ASTRA J Caravan (P10) 10/10→10/15								
			 Bremskraftverstärker								
			1.3 CDTi →	70	10/10→10/14		11/10→; für Linkslenker		03.7858-0732.4	300272	ATE Ø 9 / 8" pneumatisch

	kw			 	! #		
OPEL - ASTRA J Caravan (P10) 10/10→10/15							
 Bremskraftverstärker							
1.4	64 - 74	10/10→10/15		11/10→; für Linkslenker		03.7858-0732.4 300272	ATE Ø 9 / 8" pneumatisch
1.4 Turbo	88 - 103	10/10→10/15					
1.6	85	10/10→10/15					
1.6 Turbo	132	10/10→10/15					
1.7 CDTI	74 - 96	10/10→10/15					
2.0 CDTI	118	10/10→10/15					
1.4 LPG	103	12/11→10/15		für Linkslenker		03.7858-0732.4 300272	ATE Ø 9 / 8" pneumatisch
1.6 CDTi	81 - 100	11/13→10/15					
1.6 SIDI	125	12/12→10/15					
2.0 BiTurbo CDTI	143	09/12→10/15					
2.0 CDTI	96 - 121	08/11→10/15					
 Hauptbremszylinder							
1.3 CDTI	70	10/10→10/14		11/10→; für Linkslenker		03.2125-0421.3 010934	ATE Ø 25,4
1.4	64 - 74	10/10→10/15		11/10→; für Rechtslenker		24.4155-0201.3 011125	ATE Ø 25,4 ohne Bremsflüssigkeitsbehälter
1.4 Turbo	88 - 103	10/10→10/15					
1.6	85	10/10→10/15					
1.6 Turbo	132	10/10→10/15					
1.7 CDTI	74 - 96	10/10→10/15					
2.0 CDTI	118	10/10→10/15					
1.4 LPG	103	12/11→10/15		für Linkslenker		03.2125-0421.3 010934	ATE Ø 25,4
				01/12→; für Rechtslenker		24.4155-0201.3 011125	ATE Ø 25,4 ohne Bremsflüssigkeitsbehälter
1.6 CDTi	81	02/14→10/15		für Linkslenker		03.2125-0421.3 010934	ATE Ø 25,4
1.6 SIDI	125	12/12→10/15		für Rechtslenker		24.4155-0201.3 011125	ATE Ø 25,4 ohne Bremsflüssigkeitsbehälter
2.0 CDTI	96 - 121	08/11→10/15					
1.6 CDTi	100	11/13→10/15		für Linkslenker		03.2125-0421.3 010934	ATE Ø 25,4
				01/14→; für Rechtslenker		24.4155-0201.3 011125	ATE Ø 25,4 ohne Bremsflüssigkeitsbehälter
2.0 BiTurbo CDTI	143	09/12→10/15		für Linkslenker		03.2125-0421.3 010934	ATE Ø 25,4
				12/12→; für Rechtslenker		24.4155-0201.3 011125	ATE Ø 25,4 ohne Bremsflüssigkeitsbehälter
OPEL - ASTRA J GTC 10/11→							
 Bremskraftverstärker							
1.4	74 - 88	10/11→10/20		für Linkslenker		03.7858-0732.4 300272	ATE Ø 9 / 8" pneumatisch
1.4 Turbo	103	10/11→10/20					
1.6 CDTI	81 - 100	07/14→10/20					
1.6 SIDI	125 - 147	12/12→10/20					
1.6 Turbo	132	10/11→10/20					
1.7 CDTI	81 - 96	10/11→10/20					
1.8	103	10/11→10/20					
2.0 CDTI	96 - 121	10/11→10/20					
2.0 BiTurbo CDTI	143	10/12→10/20		12/12→; für Linkslenker		03.7858-0732.4 300272	ATE Ø 9 / 8" pneumatisch
 Hauptbremszylinder							
1.4	74 - 88	10/11→10/20		für Linkslenker		03.2125-0421.3 010934	ATE Ø 25,4
1.4 Turbo	103	10/11→10/20		für Rechtslenker		24.4155-0201.3 011125	ATE Ø 25,4 ohne Bremsflüssigkeitsbehälter
1.6 CDTI	81 - 100	07/14→10/20					
1.6 SIDI	125 - 147	12/12→10/20					
1.6 Turbo	132	10/11→10/20					
1.7 CDTI	81 - 96	10/11→10/20					
1.8	103	10/11→10/20					
2.0 CDTI	96 - 121	10/11→10/20					
2.0 BiTurbo CDTI	143	10/12→10/20		12/12→; für Linkslenker		03.2125-0421.3 010934	ATE Ø 25,4
				12/12→; für Rechtslenker		24.4155-0201.3 011125	ATE Ø 25,4 ohne Bremsflüssigkeitsbehälter













	kw			 	! #		
OPEL - ASTRA J Kasten/Kombi (P10) 09/09→10/15							
 Bremskraftverstärker							
1.3 CDTi 1.6 CDTi 1.7 CDTi 2.0 CDTi	70 81 96 121	10/12→10/15 01/14→10/15 10/12→10/15 10/12→10/15		für Linkslenker		03.7858-0732.4 300272	ATE Ø 9 / 8" pneumatisch
 Hauptbremszylinder							
1.3 CDTi 1.6 CDTi 1.7 CDTi 2.0 CDTi	70 81 96 121	10/12→10/15 01/14→10/15 10/12→10/15 10/12→10/15		für Linkslenker		03.2125-0421.3 010934	ATE Ø 25,4
				für Rechtslenker		24.4155-0201.3 011125	ATE Ø 25,4 ohne Bremsflüssigkeitsbehälter
OPEL - ASTRA J Kasten/Schrägheck (P10) 09/09→10/15							
 Bremskraftverstärker							
1.3 CDTi 1.6 CDTi 1.7 CDTi	70 81 - 100 81	05/13→10/15 05/13→10/15 05/13→10/15 05/13→10/15		für Linkslenker		03.7858-0732.4 300272	ATE Ø 9 / 8" pneumatisch
 Hauptbremszylinder							
1.3 CDTi 1.6 CDTi 1.7 CDTi	70 81 - 100 81	05/13→10/15 05/13→10/15 05/13→10/15 05/13→10/15		für Linkslenker		03.2125-0421.3 010934	ATE Ø 25,4
				für Rechtslenker		24.4155-0201.3 011125	ATE Ø 25,4 ohne Bremsflüssigkeitsbehälter
OPEL - ASTRA J Stufenheck 06/12→							
 Bremskraftverstärker							
1.3 CDTi 1.4 1.4 LPG 1.4 Turbo 1.6 1.6 CDTi 1.6 SIDI 1.6 Turbo 1.7 CDTi	70 64 - 74 103 88 - 103 85 81 - 100 125 132 74 - 96	06/12→10/15 06/12→10/15 07/14→ 06/12→ 06/12→ 01/14→ 06/12→10/15 06/12→ 06/12→10/15 06/12→ 06/12→10/15 06/12→10/15		für Linkslenker		03.7858-0732.4 300272	ATE Ø 9 / 8" pneumatisch
 Hauptbremszylinder							
1.3 CDTi 1.4 1.4 LPG 1.4 Turbo 1.6 1.6 CDTi 1.6 SIDI 1.6 Turbo 1.7 CDTi	70 64 - 74 103 88 - 103 85 81 - 100 125 132 74 - 96	06/12→10/15 06/12→10/15 07/14→ 06/12→ 06/12→ 01/14→ 06/12→10/15 06/12→ 06/12→10/15 06/12→10/15		für Linkslenker		03.2125-0421.3 010934	ATE Ø 25,4
				für Rechtslenker		24.4155-0201.3 011125	ATE Ø 25,4 ohne Bremsflüssigkeitsbehälter
OPEL - CASCADA (W13) 03/13→04/19							
 Bremskraftverstärker							
1.4 1.4 Turbo 1.6 1.6 SIDI 2.0 CDTi	88 103 100 - 147 125 121 - 143	04/13→04/18 03/13→04/18 11/13→04/19 04/13→04/19 04/13→04/18		für Linkslenker		03.7858-0732.4 300272	ATE Ø 9 / 8" pneumatisch
 Hauptbremszylinder							
1.4 1.4 Turbo 1.6 1.6 SIDI 2.0 CDTi	88 103 100 - 147 125 121 - 143	04/13→04/18 03/13→04/18 11/13→04/19 04/13→04/19 04/13→04/18		für Linkslenker		03.2125-0421.3 010934	ATE Ø 25,4
				für Rechtslenker		24.4155-0201.3 011125	ATE Ø 25,4 ohne Bremsflüssigkeitsbehälter











	kW					! #		
OPEL - COMBO Kasten/Großraumlimousine 10/01 →								
 Hauptbremszylinder								
1.3 CDTI 16V	51	08/05 →			→ 33999999		24.2122-1740.3 010711	DEL Ø 22,2
1.4 16V	55							
1.6	66	08/05 →			43000001 →; → 10/11; - ESP; Scheibenbremse		24.2123-1767.3 010844	BOS Ø 23,8
1.7 DI 16V	64	10/01 →						
1.7 DTI 16V	48	10/01 →						
	55	10/01 →						
1.6 CNG 16V	69	04/05 →			→ 10/11; - ESP; Scheibenbremse		24.2123-1767.3 010844	BOS Ø 23,8
	71							
1.7 CDTI 16V	74	12/04 →						
OPEL - COMBO Kasten/Großraumlimousine (71_) 07/94 → 10/01								
 Hauptbremszylinder								
1.2	33	07/94 → 10/01			→ 09/00; für Linkslenker; - ABS		24.2120-0702.3 010361	nicht für Delco Ø 20,6
1.4	44	07/94 → 10/01			→ 09/00; für Linkslenker; + ABS		24.2120-1714.3 010455	Ø 20,6
	60							
1.4 16V	66	08/99 → 10/01						
1.7 D	44	07/94 → 10/01						
OPEL - COMBO Tour 10/01 → 12/11								
 Hauptbremszylinder								
1.3 CDTI 16V	51	06/04 → 01/11			→ 33999999		24.2122-1740.3 010711	DEL Ø 22,2
1.6	62 - 64	10/01 → 09/06			43000001 →; - ESP; Scheibenbremse		24.2123-1767.3 010844	BOS Ø 23,8
1.7 DI 16V	48	10/01 → 06/04						
1.7 DTI 16V	55	10/01 → 06/04						
1.3 CDTI 16V	55	10/05 → 12/11			→ 33999999		24.2122-1740.3 010711	DEL Ø 22,2
1.4	66	10/04 → 12/11			43000001 →; → 10/11; - ESP; Scheibenbremse		24.2123-1767.3 010844	BOS Ø 23,8
1.6 CNG	69	06/06 → 12/11			→ 10/11; - ESP; Scheibenbremse		24.2123-1767.3 010844	BOS Ø 23,8
1.7 CDTI 16V	74	07/04 → 12/11						
1.6 CNG	71	04/05 → 01/11			- ESP; Scheibenbremse		24.2123-1767.3 010844	BOS Ø 23,8
OPEL - CORSA B (S93) 03/93 → 10/09								
 Hauptbremszylinder								
1.0 i 12V	40	11/96 → 09/00			für Linkslenker; - ABS		24.2120-0702.3 010361	nicht für Delco Ø 20,6
1.2 i	33	03/93 → 09/00			für Linkslenker; + ABS		24.2120-1714.3 010455	Ø 20,6
1.4 i	40 - 44	03/93 → 09/00						
1.4 i 16V	63 - 66	09/94 → 09/00						
1.4 Si	60	03/93 → 09/00						
1.5 D	37	03/93 → 09/00						
1.5 TD	49	03/93 → 09/00						
1.6 i 16V	74 - 78	09/94 → 09/00						
1.7 D	44	02/96 → 09/00						
1.2 i 16V	48	03/98 → 09/00			04/98 →; für Linkslenker; - ABS		24.2120-0702.3 010361	nicht für Delco Ø 20,6
					04/98 →; für Linkslenker; + ABS		24.2120-1714.3 010455	Ø 20,6
1.6 GSI 16V	80	03/93 → 09/00			09/93 →; für Linkslenker; - ABS		24.2120-0702.3 010361	nicht für Delco Ø 20,6
					09/93 →; für Linkslenker; + ABS		24.2120-1714.3 010455	Ø 20,6
OPEL - CORSA B Kasten/Schrägheck (S93) 08/94 → 12/01								
 Hauptbremszylinder								
1.4 i	44	08/99 → 09/00			für Linkslenker; - ABS		24.2120-0702.3 010361	nicht für Delco Ø 20,6
1.7 D	44	08/99 → 09/00			für Linkslenker; + ABS		24.2120-1714.3 010455	Ø 20,6
OPEL - CORSA B Kombi (S93) 04/98 → 12/02								
 Hauptbremszylinder								
1.4 i 16V	66	01/99 → 12/02			→ 09/00; für Linkslenker; - ABS		24.2120-0702.3 010361	nicht für Delco Ø 20,6
1.7 D	44	01/99 → 12/02			→ 09/00; für Linkslenker; + ABS		24.2120-1714.3 010455	Ø 20,6
OPEL - CORSA C (X01) 09/00 → 12/09								
 Hauptbremszylinder								
1.0	43 - 44	09/00 → 12/09			→ 36999999		24.2122-1740.3 010711	DEL Ø 22,2
1.2	55	09/00 → 12/09						
1.2 Twinport	59	07/04 → 12/09						
1.3 CDTI	51	06/03 → 12/09						
1.7 CDTI	74	06/03 → 12/09						
1.7 DI	48	09/00 → 12/09						
1.7 DTI	55	09/00 → 12/09						
1.4	60	01/02 → 12/09			43000001 →; - ESP		24.2123-1767.3 010844	BOS Ø 23,8
→								

	kw			 	! #		
OPEL - CORSA C (X01) 09/00→12/09							
 Hauptbremszylinder							
1.8	79	01/02→12/09		43000001→; - ESP		24.2123-1767.3 010844	BOS Ø 23,8
1.4	66	09/00→12/09		43000001→; → 09/06; - ESP		24.2123-1767.3 010844	BOS Ø 23,8
1.4 Twinport	66	06/03→12/09					
1.8	92	09/00→12/09					
OPEL - CORSA C Kasten/Schrägheck (X01) 09/00→12/12							
 Hauptbremszylinder							
1.2	59	07/05→06/06		→ 36999999		24.2122-1740.3 010711	DEL Ø 22,2
1.2 16V	55	09/00→07/03					
1.3 CDTI 16V	51 -	07/05→06/06					
	59						
1.7 CDTi	74	08/03→12/12					
1.7 DI 16V	48	09/00→07/03					
1.7 DTI 16V	55	09/00→07/03					
1.4	66	08/03→06/12		43000001→; → 09/06; - ESP		24.2123-1767.3 010844	BOS Ø 23,8
OPEL - CORSA D (S07) 07/06→04/15							
 Hauptbremszylinder							
1.0	44	07/06→12/10		10/06→; für Linkslenker; + ESP		24.4122-1705.3 010852	BOS Ø 22,2 ohne Bremsflüssigkeitsbehälter
1.2	59	07/06→08/14					
1.3 CDTI	55 -	07/06→08/14		10/06→; für Linkslenker; - ESP		24.4122-1709.3 010871	BOS Ø 22,2 ohne Bremsflüssigkeitsbehälter
	66						
1.4	66	07/06→08/14					
1.4 LPG	66	08/06→12/11					
1.0	48	12/09→08/14		für Linkslenker; + ESP		24.4122-1705.3 010852	BOS Ø 22,2 ohne Bremsflüssigkeitsbehälter
1.2	51 -	12/09→08/14					
	63						
1.2 LPG	55 -	08/06→08/14		für Linkslenker; - ESP		24.4122-1709.3 010871	BOS Ø 22,2 ohne Bremsflüssigkeitsbehälter
	63						
1.3 CDTI	70	06/09→08/14					
1.4	64 -	09/09→08/14					
	74						
1.4 LPG	64	09/09→08/14					
1.4	88	07/12→08/14		für Linkslenker; - ESP		24.4123-1720.3 011022	BOS Ø 23,8 ohne Bremsflüssigkeitsbehälter
1.6 Turbo	155	06/11→08/14					
1.7 CDTI	96	12/09→08/14					
1.6 Turbo	110	05/07→08/14		06/07→; für Linkslenker; - ESP		24.4123-1720.3 011022	BOS Ø 23,8 ohne Bremsflüssigkeitsbehälter
1.6 Turbo	141	11/06→08/14		03/07→; für Linkslenker; - ESP		24.4123-1720.3 011022	BOS Ø 23,8 ohne Bremsflüssigkeitsbehälter
1.7 CDTI	92	08/06→12/11		10/06→; für Linkslenker; - ESP		24.4123-1720.3 011022	BOS Ø 23,8 ohne Bremsflüssigkeitsbehälter
OPEL - CORSA D Kasten/Schrägheck (S07) 07/06→08/14							
 Hauptbremszylinder							
1.0	44	08/06→08/14		10/06→; für Linkslenker; + ESP		24.4122-1705.3 010852	BOS Ø 22,2 ohne Bremsflüssigkeitsbehälter
1.3 CDTI	55 -	07/06→08/14					
	66			10/06→; für Linkslenker; - ESP		24.4122-1709.3 010871	BOS Ø 22,2 ohne Bremsflüssigkeitsbehälter
1.0	48	01/10→08/14		für Linkslenker; + ESP		24.4122-1705.3 010852	BOS Ø 22,2 ohne Bremsflüssigkeitsbehälter
1.2	51 -	08/06→08/14					
	63						
1.3 CDTI	70	11/09→08/14		für Linkslenker; - ESP		24.4122-1709.3 010871	BOS Ø 22,2 ohne Bremsflüssigkeitsbehälter
1.4	74	07/12→08/14					
1.4	88	07/12→08/14		für Linkslenker; - ESP		24.4123-1720.3 011022	BOS Ø 23,8 ohne Bremsflüssigkeitsbehälter
1.6	141	07/12→08/14					
1.7 CDTI	96	07/12→08/14					
OPEL - CORSA E (X15) 09/14→							
 Hauptbremszylinder							
1.0	66 -	09/14→		11/14→; für Linkslenker; Scheibenbremse		24.4123-1722.3 011071	Ø 23,8 ohne Bremsflüssigkeitsbehälter
	85						
1.2	51	09/14→					
1.3 CDTI	55 -	09/14→					
	70						
1.4	55 -	09/14→					
	66						
1.4 Turbo	74	09/14→06/19					
1.4 LPG	64 -	03/15→		für Linkslenker; Scheibenbremse		24.4123-1722.3 011071	Ø 23,8 ohne Bremsflüssigkeitsbehälter
	66						
1.6 Turbo	152	03/15→		für Linkslenker		24.4123-1722.3 011071	Ø 23,8 ohne Bremsflüssigkeitsbehälter















	kw					! #		
OPEL - CORSA E Kasten/Schrägheck (X15) 09/14→								
 Hauptbremszylinder								
1.2	51	01/15→			für Linkslenker; Scheibenbremse		24.4123-1722.3 011071	Ø 23,8 ohne Bremsflüssigkeitsbehälter
1.3 CDTI	55	01/15→						
1.3 CDTI	70	09/14→			11/14→; für Linkslenker; Scheibenbremse		24.4123-1722.3 011071	Ø 23,8 ohne Bremsflüssigkeitsbehälter
1.4	55 - 66	09/14→						
OPEL - CROSSLAND X / CROSSLAND (P17, P2QO) 03/17→								
 Hauptbremszylinder								
1.2	60 - 96	03/17→					24.4123-1704.3 010828	TRW Ø 23,8
1.2 LPG	60	10/17→						
1.5	81	10/20→						
1.5 Turbo D	75 - 88	06/18→						
1.6 Turbo D	73 - 88	03/17→						
OPEL - CROSSLAND X Van 03/17→								
 Hauptbremszylinder								
1.2	61 - 81	07/19→					24.4123-1704.3 010828	TRW Ø 23,8
1.5	75	06/18→						
OPEL - INSIGNIA A (G09) 07/08→03/17								
 Bremskraftverstärker								
1.4	103	04/11→03/17			06/11→; für Linkslenker		03.7858-0732.4 300272	ATE Ø 9 / 8" pneumatisch
1.4 LPG	103	07/12→03/17			für Linkslenker		03.7858-0732.4 300272	ATE Ø 9 / 8" pneumatisch
1.6	85	07/08→03/17						
1.6 CDTi	88 - 100	07/15→03/17						
1.6 SIDI	125	03/13→03/17						
1.8	103	07/08→03/17						
2.0 Biturbo CDTI	140 - 143	07/08→03/17						
2.0 Biturbo CDTI 4x4	140 - 143	05/09→03/17						
2.0 CDTI	81 - 125	07/08→03/17						
2.0 CDTI 4x4	118 - 125	06/10→03/17						
2.0 E85 Turbo	162	10/10→03/17						
2.0 Turbo	162 - 184	07/08→03/17						
2.0 Turbo 4x4	162 - 184	07/08→03/17						
1.6 Turbo	132	07/08→03/17			10/08→; für Linkslenker		03.7858-0732.4 300272	ATE Ø 9 / 8" pneumatisch
2.0 CDTI	88	03/12→03/17			03/13→; für Linkslenker		03.7858-0732.4 300272	ATE Ø 9 / 8" pneumatisch
 Hauptbremszylinder								
1.4	103	04/11→03/17			06/11→; für Linkslenker		03.2125-0421.3 010934	ATE Ø 25,4
					06/11→; für Rechtslenker		24.4155-0201.3 011125	ATE Ø 25,4 ohne Bremsflüssigkeitsbehälter
1.4 LPG	103	07/12→03/17			für Linkslenker		03.2125-0421.3 010934	ATE Ø 25,4
1.6	85	07/08→03/17						
1.6 CDTi	88 - 100	07/15→03/17			für Rechtslenker		24.4155-0201.3 011125	ATE Ø 25,4 ohne Bremsflüssigkeitsbehälter
1.6 SIDI	125	03/13→03/17						
1.8	103	07/08→03/17						
2.0 Biturbo CDTI	140 - 143	07/08→03/17						
2.0 Biturbo CDTI 4x4	140 - 143	05/09→03/17						
2.0 CDTI	81 - 125	07/08→03/17						
2.0 CDTI 4x4	118 - 125	06/10→03/17						
2.0 E85 Turbo	162	10/10→03/17						
2.0 Turbo	162 - 184	07/08→03/17						
2.0 Turbo 4x4	162	07/08→03/17						
2.8 V6 Turbo 4x4	191	07/08→03/17						
2.8 V6 Turbo OPC 4x4	239	07/09→03/17						
1.6 Turbo	132	07/08→03/17			10/08→; für Linkslenker		03.2125-0421.3 010934	ATE Ø 25,4
					10/08→; für Rechtslenker		24.4155-0201.3 011125	ATE Ø 25,4 ohne Bremsflüssigkeitsbehälter
2.0 CDTI	88	03/12→03/17			03/13→; für Linkslenker		03.2125-0421.3 010934	ATE Ø 25,4
→								





























	kw			 	! #		
OPEL - INSIGNIA A (G09) 07/08→03/17							
 Hauptbremszylinder							
2.0 CDTi	88	03/12→03/17		03/13→; für Rechtslenker		24.4155-0201.3 011125	ATE Ø 25,4 ohne Bremsflüssigkeitsbehälter
2.0 CDTi	103	06/13→03/17		für Linkslenker		03.2125-0421.3 010934	ATE Ø 25,4
				07/13→; für Rechtslenker		24.4155-0201.3 011125	ATE Ø 25,4 ohne Bremsflüssigkeitsbehälter
2.0 Turbo 4x4	184	07/11→03/17		für Linkslenker		03.2125-0421.3 010934	ATE Ø 25,4
				09/11→; für Rechtslenker		24.4155-0201.3 011125	ATE Ø 25,4 ohne Bremsflüssigkeitsbehälter
OPEL - INSIGNIA A Country Tourer (G09) 07/08→03/17							
 Bremskraftverstärker							
1.6 CDTi	88 - 100	07/15→03/17		für Linkslenker		03.7858-0732.4 300272	ATE Ø 9 / 8" pneumatisch
1.6 SIDI	125	07/14→03/17					
2.0 CDTi	88 - 125	07/08→03/17					
2.0 CDTi 4x4	120 - 143	09/13→03/17					
2.0 Turbo 4x4	184	09/13→03/17					
 Hauptbremszylinder							
1.6 CDTi	88 - 100	07/15→03/17		für Linkslenker		03.2125-0421.3 010934	ATE Ø 25,4
1.6 SIDI	125	07/14→03/17		für Rechtslenker		24.4155-0201.3 011125	ATE Ø 25,4 ohne Bremsflüssigkeitsbehälter
2.0 CDTi	88 - 125	07/08→03/17					
2.0 CDTi 4x4	120 - 143	09/13→03/17					
2.0 Turbo 4x4	184	09/13→03/17					
OPEL - INSIGNIA A Sports Tourer (G09) 07/08→03/17							
 Bremskraftverstärker							
1.4	103	04/11→03/17		für Linkslenker		03.7858-0732.4 300272	ATE Ø 9 / 8" pneumatisch
1.4 LPG	103	09/12→03/17					
1.6	85	07/08→06/12					
1.6 CDTi	88 - 100	07/15→01/17					
1.6 SIDI	125	06/13→03/17					
1.6 Turbo	132	01/09→06/13					
1.8	103	07/08→03/17					
2.0 Biturbo CDTi	140 - 143	07/08→03/17					
2.0 Biturbo CDTi 4x4	140 - 143	07/08→03/17					
2.0 CDTi	81 - 125	07/08→12/16					
2.0 CDTi 4x4	118 - 125	06/10→12/16					
2.0 E85 Turbo	162	09/10→11/11					
2.0 Turbo	162 - 184	07/08→03/17					
2.0 Turbo 4x4	162 - 184	07/08→06/13					
2.0 CDTi	88	03/12→06/15		03/13→; für Linkslenker		03.7858-0732.4 300272	ATE Ø 9 / 8" pneumatisch
 Hauptbremszylinder							
1.4	103	04/11→03/17		für Linkslenker		03.2125-0421.3 010934	ATE Ø 25,4
1.4 LPG	103	09/12→03/17		für Rechtslenker		24.4155-0201.3 011125	ATE Ø 25,4 ohne Bremsflüssigkeitsbehälter
1.6	85	07/08→06/12					
1.6 CDTi	88 - 100	07/15→01/17					
1.6 SIDI	125	06/13→03/17					
1.6 Turbo	132	01/09→06/13					
1.8	103	07/08→03/17					
2.0 Biturbo CDTi	140 - 143	07/08→03/17					
2.0 Biturbo CDTi 4x4	140 - 143	07/08→03/17					
2.0 CDTi	81 - 125	07/08→12/16					
2.0 CDTi 4x4	118 - 125	06/10→12/16					
2.0 E85 Turbo	162	09/10→11/11					
2.0 Turbo	162 - 184	07/08→03/17					
2.0 Turbo 4x4	162 - 184	07/08→06/13					
2.8 V6 Turbo 4x4	191	10/08→06/13					













	kw			 	! #		
OPEL - INSIGNIA A Sports Tourer (G09) 07/08→03/17							
 Hauptbremszylinder							
2.8 V6 Turbo OPC 4x4	239	07/09→03/17		für Linkslenker		03.2125-0421.3 010934	ATE Ø 25,4
				für Rechtslenker		24.4155-0201.3 011125	ATE Ø 25,4 ohne Bremsflüssigkeitsbehälter
2.0 CDTI	88	03/12→06/15		03/13→; für Linkslenker		03.2125-0421.3 010934	ATE Ø 25,4
				03/13→; für Rechtslenker		24.4155-0201.3 011125	ATE Ø 25,4 ohne Bremsflüssigkeitsbehälter
OPEL - INSIGNIA A Stufenheck (G09) 07/08→03/17							
 Bremskraftverstärker							
1.4	103	04/11→03/17		06/11→; für Linkslenker		03.7858-0732.4 300272	ATE Ø 9 / 8" pneumatisch
1.4 LPG	103	07/12→03/17		für Linkslenker		03.7858-0732.4 300272	ATE Ø 9 / 8" pneumatisch
1.6	85	07/08→03/17					
1.6 CDTi	88 - 100	07/15→03/17					
1.6 SIDI	125	03/13→03/17					
1.6 Turbo	132	07/08→03/17					
1.8	103	07/08→03/17					
2.0 Biturbo CDTI	140 - 143	07/08→03/17					
2.0 Biturbo CDTI 4x4	140 - 143	07/08→03/17					
2.0 CDTI	81 - 125	07/08→03/17					
2.0 CDTI 4x4	118 - 125	06/10→03/17					
2.0 Turbo	162 - 184	07/08→03/17					
2.0 Turbo 4x4	162 - 184	07/08→03/17					
2.0 Turbo E85	162	07/08→03/17					
2.0 CDTI	88	03/12→03/17		03/13→; für Linkslenker		03.7858-0732.4 300272	ATE Ø 9 / 8" pneumatisch
 Hauptbremszylinder							
1.4	103	04/11→03/17		06/11→; für Linkslenker		03.2125-0421.3 010934	ATE Ø 25,4
				06/11→; für Rechtslenker		24.4155-0201.3 011125	ATE Ø 25,4 ohne Bremsflüssigkeitsbehälter
1.4 LPG	103	07/12→03/17		für Linkslenker		03.2125-0421.3 010934	ATE Ø 25,4
1.6	85	07/08→03/17					
1.6 CDTi	88 - 100	07/15→03/17		für Rechtslenker		24.4155-0201.3 011125	ATE Ø 25,4 ohne Bremsflüssigkeitsbehälter
1.6 SIDI	125	03/13→03/17					
1.8	103	07/08→03/17					
2.0 Biturbo CDTI	140 - 143	07/08→03/17					
2.0 Biturbo CDTI 4x4	140 - 143	07/08→03/17					
2.0 CDTI	81 - 125	07/08→03/17					
2.0 CDTI 4x4	118 - 125	06/10→03/17					
2.0 Turbo	162 - 184	07/08→03/17					
2.0 Turbo 4x4	162	07/08→03/17					
2.0 Turbo E85	162	07/08→03/17					
2.8 V6 Turbo 4x4	191	07/08→03/17					
2.8 V6 Turbo OPC 4x4	239	07/09→03/17					
1.6 Turbo	132	07/08→03/17		für Linkslenker		03.2125-0421.3 010934	ATE Ø 25,4
				10/08→; für Rechtslenker		24.4155-0201.3 011125	ATE Ø 25,4 ohne Bremsflüssigkeitsbehälter
2.0 CDTI	88	03/12→03/17		03/13→; für Linkslenker		03.2125-0421.3 010934	ATE Ø 25,4
				03/13→; für Rechtslenker		24.4155-0201.3 011125	ATE Ø 25,4 ohne Bremsflüssigkeitsbehälter
2.0 CDTI	103	06/13→03/17		für Linkslenker		03.2125-0421.3 010934	ATE Ø 25,4
				07/13→; für Rechtslenker		24.4155-0201.3 011125	ATE Ø 25,4 ohne Bremsflüssigkeitsbehälter
2.0 Turbo 4x4	184	07/11→03/17		für Linkslenker		03.2125-0421.3 010934	ATE Ø 25,4
				09/11→; für Rechtslenker		24.4155-0201.3 011125	ATE Ø 25,4 ohne Bremsflüssigkeitsbehälter
OPEL - MERIVA A Großraumlimousine (X03) 05/03→05/10							
 Hauptbremszylinder							
1.3 CDTI	51 - 55	09/03→05/10		54000001→ 74237191; - ESP		03.2120-2598.3 010116	ATE Ø 20,6
1.4 16V Twinport →	66	07/04→05/10		→ 44999999; - ESP		24.2123-1764.3 010824	TRW Ø 23,8

























	kw			 	! #		
OPEL - MERIVA A Großraumlimousine (X03) 05/03→05/10							
 Hauptbremszylinder							
1.4 16V Twinport LPG 1.6	66 64 - 77	07/04→05/10 05/03→05/10		74237192→; + ESP		24.4123-1717.3 010985	TRW Ø 23,8 ohne Bremsflüssigkeitsbehälter
1.6 16V 1.6 Turbo 1.7 CDTI	74 132 74 - 92	05/03→01/06 09/05→05/10 09/03→05/10					
1.7 DTI 1.8	55 92	09/03→05/10 05/03→05/10					
OPEL - MOKKA / MOKKA X (J13) 06/12→							
 Hauptbremszylinder							
1.4 1.4 4x4 1.4 LPG 1.6 1.6 CDTI 1.6 CDTI 4x4 1.7 CDTI 1.7 CDTI 4x4 1.8 1.8 4x4	88 - 103 103 - 112 103 85 81 - 100 81 - 100 96 96 103 103	04/13→ 06/12→ 04/13→ 06/12→ 01/15→ 01/15→ 06/12→ 06/12→ 01/13→ 01/13→		für Linkslenker		24.4123-1738.3 011124	Ø 23,8 ohne Bremsflüssigkeitsbehälter
OPEL - MOKKA X VAN (J13) 06/12→							
 Hauptbremszylinder							
1.6 CDTi	100	03/18→		für Linkslenker		24.4123-1738.3 011124	Ø 23,8 ohne Bremsflüssigkeitsbehälter
OPEL - MOVANO A Bus (X70) 07/98→							
 Hauptbremszylinder							
1.9 DTI 2.5 D 2.8 DTI	59 59 84	09/00→10/01 07/98→09/00 07/98→10/01		+ ABS - ABS		24.2025-1706.3 010676 24.2025-1708.3 010692	Ø 25,4 Ø 25,4
1.9 DTI 2.2 DTI 2.5 DTI	60 66 84	10/01→ 09/00→ 10/01→		→ 08/03; + ABS → 01/10; - ABS 09/03→; + ABS; → 08/06		24.2025-1706.3 010676 24.2025-1708.3 010692 24.2123-1759.3 010768	Ø 25,4 Ø 25,4 BOS Ø 23,8
3.0 DTi	100	10/03→		→ 01/10; - ABS → 08/06; + ABS		24.2025-1708.3 010692 24.2123-1759.3 010768	Ø 25,4 BOS Ø 23,8
OPEL - MOVANO A Kasten (X70) 01/99→							
 Hauptbremszylinder							
1.9 DTI 2.5 D 2.8 DTI	59 59 84	09/00→10/01 01/99→09/00 01/99→10/01		+ ABS - ABS		24.2025-1706.3 010676 24.2025-1708.3 010692	Ø 25,4 Ø 25,4
1.9 DTI 2.2 DTI 2.5 DTI	60 66 84	10/01→ 09/00→ 10/01→		→ 08/03; + ABS → 01/10; - ABS 09/03→; + ABS; → 08/06		24.2025-1706.3 010676 24.2025-1708.3 010692 24.2123-1759.3 010768	Ø 25,4 Ø 25,4 BOS Ø 23,8
2.5 DTi 3.0 DTI	73 100	10/03→ 10/03→		→ 01/10; - ABS → 08/06; + ABS		24.2025-1708.3 010692 24.2123-1759.3 010768	Ø 25,4 BOS Ø 23,8
OPEL - MOVANO A Pritsche/Fahrgestell (X70) 07/98→							
 Hauptbremszylinder							
2.2 DTI 2.5 DTI	66 84	09/00→ 10/01→		→ 08/03; + ABS → 01/10; - ABS 09/03→; + ABS; → 08/06		24.2025-1706.3 010676 24.2025-1708.3 010692 24.2123-1759.3 010768	Ø 25,4 Ø 25,4 BOS Ø 23,8
2.5 D 2.8 DTI	59 84	07/98→09/00 07/98→10/01		+ ABS - ABS		24.2025-1706.3 010676 24.2025-1708.3 010692	Ø 25,4 Ø 25,4
2.5 DTi 3.0 DTI	73 100	10/03→ 10/03→		→ 01/10; - ABS + ABS; → 08/06		24.2025-1708.3 010692 24.2123-1759.3 010768	Ø 25,4 BOS Ø 23,8
OPEL - OMEGA B (V94) 03/94→12/05							
 Hauptbremszylinder							
2.0 2.0 16V 2.5 TD →	85 100 96	03/94→09/99 03/94→09/99 04/94→07/03		W1000001→; für Linkslenker; + ESP		24.2125-1740.3 010971	TRW Ø 25,4













	kW					! #		
OPEL - OMEGA B (V94) 03/94→12/05								
 Hauptbremszylinder								
2.0	85	03/94→12/00		W1000001→; → 09/99; für Linkslenker; + ESP			24.2125-1740.3 010971	TRW Ø 25,4
2.0 DTI 16V	74	09/97→09/00		→ 08/00; für Linkslenker; + ESP			24.2125-1740.3 010971	TRW Ø 25,4
2.2 16V	106	09/99→07/03		10/99→; für Linkslenker; + ESP			24.2125-1740.3 010971	TRW Ø 25,4
2.2 DTI 16V	81 - 88	09/00→07/03		für Linkslenker; + ESP			24.2125-1740.3 010971	TRW Ø 25,4
2.5 DTI	110	09/01→07/03						
2.5 V6	125	03/94→09/00		W1000001→; für Linkslenker; nicht für Sonderfahrzeuge; + ESP			24.2125-1740.3 010971	TRW Ø 25,4
2.6 V6	132	09/00→07/03		für Linkslenker; nicht für Sonderfahrzeuge; + ESP			24.2125-1740.3 010971	TRW Ø 25,4
3.2 V6	160	02/01→07/03						
3.0 V6	155	04/94→02/01		W1000001→; → 01/01; für Linkslenker; nicht für Sonderfahrzeuge; + ESP			24.2125-1740.3 010971	TRW Ø 25,4
OPEL - OMEGA B Caravan (V94) 03/94→07/03								
 Hauptbremszylinder								
2.0	85	03/94→09/99		W1000001→; für Linkslenker; + ESP			24.2125-1740.3 010971	TRW Ø 25,4
2.0 16V	100	03/94→09/99						
2.5 TD	96	04/94→07/01						
2.0 DTI 16V	74	09/97→09/00		→ 08/00; für Linkslenker; + ESP			24.2125-1740.3 010971	TRW Ø 25,4
2.2 16V	106	09/99→07/03		für Linkslenker; + ESP			24.2125-1740.3 010971	TRW Ø 25,4
2.2 DTI 16V	81 - 88	09/00→07/03						
2.5 DTI	110	09/01→07/03						
2.5 V6	125	03/94→09/00		W1000001→; für Linkslenker; nicht für Sonderfahrzeuge; + ESP			24.2125-1740.3 010971	TRW Ø 25,4
2.6 V6	132	09/00→07/03		für Linkslenker; nicht für Sonderfahrzeuge; + ESP			24.2125-1740.3 010971	TRW Ø 25,4
3.2 V6	160	02/01→07/03						
3.0 V6	155	04/94→02/01		W1000001→; → 01/01; für Linkslenker; nicht für Sonderfahrzeuge; + ESP			24.2125-1740.3 010971	TRW Ø 25,4
OPEL - SIGNUM CC (Z03) 05/03→12/08								
 Hauptbremszylinder								
1.8	90	05/03→07/05		für Linkslenker; + ESP			24.2125-1732.3 010827	TRW Ø 25,4
1.9 CDTI	74 - 110	04/04→02/08						
2.0 DTI	74	05/03→04/04						
2.2 DTI	92	05/03→04/04						
3.0 V6 CDTI	130	05/03→07/05						
3.2 V6	155	05/03→07/05						
1.8	103	09/05→12/08		für Linkslenker; → 05/08; + ESP			24.2125-1732.3 010827	TRW Ø 25,4
2.0 Turbo	129	05/03→12/08						
2.2 direct	114	05/03→09/08						
3.0 V6 CDTI	135	09/05→12/08						
OPEL - TIGRA (S93) 07/94→12/00								
 Hauptbremszylinder								
1.4 16V	63 - 66	07/94→12/00		für Linkslenker; - ABS			24.2120-0702.3 010361	nicht für Delco Ø 20,6
				für Linkslenker; + ABS			24.2120-1714.3 010455	Ø 20,6
OPEL - TIGRA TwinTop (X04) 06/04→12/10								
 Hauptbremszylinder								
1.3 CDTI	51	06/04→12/10		- ESP; → 08/09			24.2123-1767.3 010844	BOS Ø 23,8
1.4	66	06/04→12/10						
1.8	92	06/04→12/10						
OPEL - VECTRA B (J96) 09/95→07/04								
 Bremskraftverstärker								
2.0 i	82	10/95→04/02		für Linkslenker; → W1285446			03.7745-3003.4 300157	ATE Ø 8 / 7" pneumatisch
2.0 i 16V	100	09/95→06/00						
2.5 i V6	125	10/95→09/00		für Linkslenker			03.7745-3003.4 300157	ATE Ø 8 / 7" pneumatisch
2.6 i V6	125	09/00→04/02						
 Hauptbremszylinder								
1.6 i	55	10/95→04/02		→ W1999999; für Rechtslenker			24.2122-1724.3 010561	Ø 22,2
1.6 i 16V	74	10/95→04/02		→ V5999999; für Linkslenker			24.2122-1724.3 010561	Ø 22,2
1.8 i 16V	85 - 92	10/95→04/02		→ W7999999; für Rechtslenker			24.2122-1724.3 010561	Ø 22,2
2.0 DI 16V	60	11/96→04/02		→ W5999999; für Rechtslenker			24.2122-1724.3 010561	Ø 22,2
2.0 DTI 16V	74	06/97→04/02		→ V1999999; für Linkslenker			24.2122-1724.3 010561	Ø 22,2
				→ V7999999; für Linkslenker			24.2122-1724.3 010561	Ø 22,2
→								











	kw					! #		
OPEL - VECTRA B (J96) 09/95→07/04								
 Hauptbremszylinder								
1.6 i	55	10/95→04/02		W7000001→W7999999; für Linkslenker		24.2123-1777.3	010943	Ø 23,8
1.6 i 16V	74	10/95→04/02		W5000001→W5999999; für Linkslenker		24.2123-1777.3	010943	Ø 23,8
1.8 i 16V	85 - 92	10/95→04/02		W1000001→W1999999; für Linkslenker		24.2123-1777.3	010943	Ø 23,8
2.0 DI 16V	60	11/96→04/02						
2.0 DTI 16V	74	06/97→04/02						
2.0 i	82	10/95→04/02		→ W1285446; für Linkslenker		03.2123-1622.3	010470	Ø 23,8
2.0 i 16V	100	09/95→06/00		→ W5276825; für Linkslenker		03.2123-1622.3	010470	Ø 23,8
2.5 i V6	125	10/95→09/00		→ W7154258; für Linkslenker		03.2123-1622.3	010470	Ø 23,8
OPEL - VECTRA B Caravan (J96) 11/96→07/03								
 Bremskraftverstärker								
2.0 i	82	11/96→02/02		für Linkslenker; → W1285446		03.7745-3003.4	300157	ATE Ø 8 / 7" pneumatisch
2.0 i 16V	85 - 100	11/96→07/03						
2.5 i V6	125	11/96→09/00		für Linkslenker		03.7745-3003.4	300157	ATE Ø 8 / 7" pneumatisch
2.6 i V6	125	09/00→07/03		→ 04/02; für Linkslenker		03.7745-3003.4	300157	ATE Ø 8 / 7" pneumatisch
 Hauptbremszylinder								
1.6 i	55	11/96→06/00		→ V1999999; für Linkslenker		24.2122-1724.3	010561	Ø 22,2
1.6 i 16V	74	11/96→07/02		→ V7999999; für Linkslenker		24.2122-1724.3	010561	Ø 22,2
1.8 i 16V	85 - 92	11/96→07/03		→ W1999999; für Rechtslenker		24.2122-1724.3	010561	Ø 22,2
2.0 DI 16V	60	11/96→06/00		→ V5999999; für Linkslenker		24.2122-1724.3	010561	Ø 22,2
2.0 DTI 16V	74	06/97→07/03		→ W7999999; für Rechtslenker		24.2122-1724.3	010561	Ø 22,2
				→ W5999999; für Rechtslenker		24.2122-1724.3	010561	Ø 22,2
				W7000001→W7999999; für Linkslenker		24.2123-1777.3	010943	Ø 23,8
				W5000001→W5999999; für Linkslenker		24.2123-1777.3	010943	Ø 23,8
				W1000001→W1999999; für Linkslenker		24.2123-1777.3	010943	Ø 23,8
2.0 i	82	11/96→02/02		→ W7154258; für Linkslenker		03.2123-1622.3	010470	Ø 23,8
2.0 i 16V	85 - 100	11/96→07/03		→ W1285446; für Linkslenker		03.2123-1622.3	010470	Ø 23,8
2.5 i V6	125	11/96→09/00		→ W5276825; für Linkslenker		03.2123-1622.3	010470	Ø 23,8
OPEL - VECTRA B CC (J96) 09/95→07/03								
 Bremskraftverstärker								
2.0 i	82	10/95→02/02		für Linkslenker; → W1285446		03.7745-3003.4	300157	ATE Ø 8 / 7" pneumatisch
2.0 i 16V	85 - 100	09/95→07/03						
2.5	144	10/99→06/00		für Linkslenker		03.7745-3003.4	300157	ATE Ø 8 / 7" pneumatisch
2.5 i V6	125	10/95→09/00						
2.6 i V6	125	09/00→07/03		→ 04/02; für Linkslenker		03.7745-3003.4	300157	ATE Ø 8 / 7" pneumatisch
 Hauptbremszylinder								
1.6 i	55	10/95→07/03		→ W5999999; für Rechtslenker		24.2122-1724.3	010561	Ø 22,2
1.6 i 16V	74	10/95→07/02		→ W1999999; für Rechtslenker		24.2122-1724.3	010561	Ø 22,2
1.8 FlexFuel	85	01/99→09/00		→ V7999999; für Linkslenker		24.2122-1724.3	010561	Ø 22,2
1.8 i 16V	85 - 92	10/95→07/03		→ W7999999; für Rechtslenker		24.2122-1724.3	010561	Ø 22,2
2.0 DI 16V	60	11/96→06/00		→ V5999999; für Linkslenker		24.2122-1724.3	010561	Ø 22,2
2.0 DTI 16V	74	06/97→07/03		→ V1999999; für Linkslenker		24.2122-1724.3	010561	Ø 22,2
				W7000001→W7999999; für Linkslenker		24.2123-1777.3	010943	Ø 23,8
				W5000001→W5999999; für Linkslenker		24.2123-1777.3	010943	Ø 23,8
				W1000001→W1999999; für Linkslenker		24.2123-1777.3	010943	Ø 23,8
2.0 i	82	10/95→02/02		→ W1285446; für Linkslenker		03.2123-1622.3	010470	Ø 23,8
2.0 i 16V	85 - 100	09/95→07/03		→ W5276825; für Linkslenker		03.2123-1622.3	010470	Ø 23,8
2.5	144	10/99→06/00		→ W7154258; für Linkslenker		03.2123-1622.3	010470	Ø 23,8
2.5 i V6	125	10/95→09/00						
OPEL - VECTRA C (Z02) 04/02→01/09								
 Hauptbremszylinder								
1.6	77	08/05→08/08		für Linkslenker; + ESP		24.2125-1732.3	010827	TRW Ø 25,4
1.6 16V	74	04/02→10/05						
1.8	81 - 103	04/02→08/08						
1.8 16V	90	04/02→09/08						
1.9 CDTI	74 - 110	04/04→08/08						
2.0 16V Turbo	129	03/03→08/08						
2.0 DTI 16V	74	04/02→08/06						

	kw			 	! #		
OPEL - VECTRA C (Z02) 04/02→01/09							
 Hauptbremszylinder							
2.2 DGi 2.2 DTI 16V	114 86 - 92	10/03→08/08 04/02→12/04		für Linkslenker; + ESP		24.2125-1732.3 010827	TRW Ø 25,4
3.0 CDTi 3.0 CDTi 3.2 V6	135 130 155	08/05→08/08 02/03→07/05 08/02→07/06					
1.9 CDTi 2.2 16V	88 108	04/04→01/09 04/02→12/08		für Linkslenker; + ESP; → 10/08		24.2125-1732.3 010827	TRW Ø 25,4
OPEL - VECTRA C Caravan (Z02) 10/03→01/09							
 Hauptbremszylinder							
1.6	77	12/05→08/08		06/06→; für Linkslenker; + ESP		24.2125-1732.3 010827	TRW Ø 25,4
1.8	90 - 103	10/03→08/08		für Linkslenker; + ESP		24.2125-1732.3 010827	TRW Ø 25,4
1.9 CDTi	74 - 110	04/04→08/08					
2.0 DTI 2.0 Turbo 2.2 direct 2.2 DTI 3.0 V6 CDTi	74 129 114 92 130 - 135	10/03→08/05 10/03→08/08 10/03→08/08 10/03→12/05 10/03→08/08					
3.2 V6	155	10/03→07/05					
1.9 CDTi	88	04/04→01/09		für Linkslenker; + ESP; → 10/08		24.2125-1732.3 010827	TRW Ø 25,4
OPEL - VECTRA C CC (Z02) 08/02→01/09							
 Hauptbremszylinder							
1.6	74 - 77	08/05→08/08		für Linkslenker; + ESP		24.2125-1732.3 010827	TRW Ø 25,4
1.8	103	08/05→08/08					
1.8 16V	81 - 90	08/02→09/08					
1.9 CDTi	74 - 110	04/04→08/08					
2.0 16V Turbo 2.0 DTI 16V 2.2 16V 2.2 DGi 2.2 DTI 16V	129 74 108 114 86 - 92	03/03→08/08 08/02→08/05 08/02→08/08 10/03→08/08 08/02→06/08					
3.0 CDTi 3.0 CDTi 3.2 V6	135 130 155	08/05→08/08 06/03→07/05 08/02→07/06					
1.9 CDTi	88	04/04→01/09		für Linkslenker; + ESP; → 10/08		24.2125-1732.3 010827	TRW Ø 25,4
OPEL - VIVARO A Bus (X83) 08/01→07/14							
 Hauptbremszylinder							
1.9 DI	60	08/01→07/06		7V600001 / 7Y000001→; + ABS		24.2120-1748.3 010894	TRW Ø 20,6
				7V600001 / 7Y000001→; + ASR		24.2120-1753.3 010946	TRW Ø 20,6
				4V602168→ 6V699999; für Rechtslenker; - ASR		24.2125-1731.3 010826	TRW Ø 25,4
1.9 DTI	74	08/01→07/14		7V600001 / 7Y000001→; → 06/14; + ABS		24.2120-1748.3 010894	TRW Ø 20,6
				7V600001 / 7Y000001→; → 06/14; + ASR		24.2120-1753.3 010946	TRW Ø 20,6
				4V602168→ 6V699999; für Rechtslenker; - ASR		24.2125-1731.3 010826	TRW Ø 25,4
2.0 16V 2.5 CDTi 2.5 DTI	88 84 99	08/01→07/06 08/06→03/10 04/03→03/10		7V600001 / 7Y000001→; + ABS		24.2120-1748.3 010894	TRW Ø 20,6
				7V600001 / 7Y000001→; + ASR		24.2120-1753.3 010946	TRW Ø 20,6
				4V602168→ 6V699999; - ASR		24.2125-1731.3 010826	TRW Ø 25,4
2.0 CDTi	66 - 84	08/06→07/14		7V600001 / 7Y000001→; → 06/14; + ABS		24.2120-1748.3 010894	TRW Ø 20,6
2.0 ECOTEC 2.5 CDTi	86 107	08/06→07/14 08/06→07/14		7V600001 / 7Y000001→; → 06/14; + ASR		24.2120-1753.3 010946	TRW Ø 20,6
				4V602168→ 6V699999; - ASR		24.2125-1731.3 010826	TRW Ø 25,4
OPEL - VIVARO A Kasten (X83) 08/01→07/14							
 Hauptbremszylinder							
1.9 DI	60	08/01→07/06		7V600001 / 7Y000001→; + ABS		24.2120-1748.3 010894	TRW Ø 20,6
				7V600001 / 7Y000001→; + ASR		24.2120-1753.3 010946	TRW Ø 20,6
				4V602168→ 6V699999; für Rechtslenker; - ASR		24.2125-1731.3 010826	TRW Ø 25,4
→							

	kw			 	! #				
OPEL - VIVARO A Kasten (X83) 08/01→07/14									
 Hauptbremszylinder									
1.9 DTI	74	08/01→07/14		7V600001 / 7Y000001→; → 06/14; + ABS	24.2120-1748.3	010894	TRW Ø 20,6		
				7V600001 / 7Y000001→; → 06/14; + ASR	24.2120-1753.3	010946	TRW Ø 20,6		
				4V602168→ 6V699999; für Rechtslenker; - ASR	24.2125-1731.3	010826	TRW Ø 25,4		
2.0 16V 2.5 CDTI 2.5 DTI	88 84 99	08/01→07/06 08/06→03/10 04/03→03/10		7V600001 / 7Y000001→; + ABS	24.2120-1748.3	010894	TRW Ø 20,6		
				7V600001 / 7Y000001→; + ASR	24.2120-1753.3	010946	TRW Ø 20,6		
				4V602168→ 6V699999; - ASR	24.2125-1731.3	010826	TRW Ø 25,4		
2.0 CDTI 2.0 ECOTEC 2.5 CDTI	66 - 84 86 107	08/06→07/14 08/06→07/14 08/06→07/14		7V600001 / 7Y000001→; → 06/14; + ABS	24.2120-1748.3	010894	TRW Ø 20,6		
				7V600001 / 7Y000001→; → 06/14; + ASR	24.2120-1753.3	010946	TRW Ø 20,6		
				4V602168→ 6V699999; - ASR	24.2125-1731.3	010826	TRW Ø 25,4		
OPEL - VIVARO A Pritsche/Fahrgestell (X83) 02/01→07/14									
 Hauptbremszylinder									
1.9 Di	60	08/01→07/14		7V600001 / 7Y000001→; → 06/14; + ABS	24.2120-1748.3	010894	TRW Ø 20,6		
				7V600001 / 7Y000001→; → 06/14; + ASR	24.2120-1753.3	010946	TRW Ø 20,6		
				4V602168→ 6V699999; für Rechtslenker; - ASR	24.2125-1731.3	010826	TRW Ø 25,4		
1.9 DTI	74	02/01→12/10		7V600001 / 7Y000001→; + ABS	24.2120-1748.3	010894	TRW Ø 20,6		
				7V600001 / 7Y000001→; + ASR	24.2120-1753.3	010946	TRW Ø 20,6		
				4V602168→ 6V699999; für Rechtslenker; - ASR	24.2125-1731.3	010826	TRW Ø 25,4		
2.0 16V 2.5 CDTI 2.5 DTI	88 84 99	01/02→07/06 08/06→03/10 04/03→03/10		7V600001 / 7Y000001→; + ABS	24.2120-1748.3	010894	TRW Ø 20,6		
				7V600001 / 7Y000001→; + ASR	24.2120-1753.3	010946	TRW Ø 20,6		
				4V602168→ 6V699999; - ASR	24.2125-1731.3	010826	TRW Ø 25,4		
2.0 CDTI 2.0 ECOTEC 2.5 CDTI	66 - 84 86 107	01/06→07/14 08/06→07/14 08/06→07/14		7V600001 / 7Y000001→; → 06/14; + ABS	24.2120-1748.3	010894	TRW Ø 20,6		
				7V600001 / 7Y000001→; → 06/14; + ASR	24.2120-1753.3	010946	TRW Ø 20,6		
				4V602168→ 6V699999; - ASR	24.2125-1731.3	010826	TRW Ø 25,4		
OPEL - ZAFIRA / ZAFIRA FAMILY B (A05) 07/05→05/19									
 Bremskraftverstärker									
1.6 1.6 CNG 1.6 CNG Turbo 1.6 FlexFuel 1.7 CDTI 1.8 1.8 LPG 1.9 CDTI 2.0 2.2	77 - 85 69 110 85 81 - 92 88 - 103 103 74 - 110 147 - 177 110	07/05→04/15 07/05→04/15 04/10→04/15 08/08→12/12 03/07→04/15 07/05→04/15 07/09→04/15 07/05→04/15 07/05→12/10 07/05→12/12		für Linkslenker; + ESP	03.7863-7803.4	300237	ATE Ø 10" pneumatisch		
 Hauptbremszylinder									
1.6 1.6 CNG Turbo 1.8 1.8 LPG 2.0	77 110 103 103 147 - 177	07/05→09/12 04/10→04/15 07/05→04/15 07/09→04/15 07/05→12/10		für Linkslenker; - ESP	03.4155-0153.3	010927	ATE Ø 25,4		
				für Linkslenker; + ESP	03.4155-0156.3	010862	ATE Ø 25,4		
				→ 6G999999; für Rechtslenker	24.2125-1736.3	010904	TRW Ø 25,4		
				72000001→; für Rechtslenker	24.4125-1703.3	010907	TRW Ø 25,4		
1.6 1.6 CNG 1.6 FlexFuel	85 69 85	01/08→04/15 07/05→04/15 08/08→12/12		für Linkslenker; - ESP	03.4155-0153.3	010927	ATE Ø 25,4		
				für Linkslenker; + ESP	03.4155-0156.3	010862	ATE Ø 25,4		
1.7 CDTI 1.9 CDTI 2.2	81 - 92 74 - 110 110	03/07→04/15 07/05→04/15 07/05→12/12		für Linkslenker; - ESP	03.4155-0153.3	010927	ATE Ø 25,4		
				für Rechtslenker	03.4155-0156.3	010862	ATE Ø 25,4		
				für Linkslenker; + ESP	03.4155-0156.3	010862	ATE Ø 25,4		
1.8	88	06/13→04/15		für Linkslenker; - ESP	03.4155-0153.3	010927	ATE Ø 25,4		
				für Linkslenker; + ESP	03.4155-0156.3	010862	ATE Ø 25,4		
				für Rechtslenker	24.4125-1703.3	010907	TRW Ø 25,4		

	kw			 	! #		
OPEL - ZAFIRA A Großraumlimousine (T98) 04/99→06/05							
 Hauptbremszylinder							
1.6	76	10/03→06/05		- ESP		24.2123-1734.3 010640	TRW Ø 23,8
1.6 16V	74	04/99→06/05		+ ESP		24.2123-1739.3 010661	Ø 23,8
1.6 CNG	71	09/01→06/05					
1.6 LPG	74 -	04/99→06/05					
	76						
1.8 16V	85 -	04/99→06/05					
	92						
2.0 DTI 16V	74	09/00→06/05					
2.0 OPC	141 -	09/01→06/05					
	147						
2.2 16V	108	09/00→06/05					
2.2 DTI 16V	86 -	01/02→06/05					
	92						
2.0 DI 16V	60	07/99→06/05		10/99→; - ESP		24.2123-1734.3 010640	TRW Ø 23,8
				10/99→; + ESP		24.2123-1739.3 010661	Ø 23,8
 Bremskraftregler							
1.6	76	10/03→06/05		- ABS		03.6583-0085.3 320238	ATE lastabhängig 8/3 4x
1.6 16V	74	04/99→06/05				03.6583-0085.3 320238	
1.6 CNG	71	09/01→06/05					
1.6 LPG	74 -	04/99→06/05					
	76						
1.8 16V	85 -	04/99→06/05					
	92						
2.0 DTI 16V	74	09/00→06/05					
2.0 OPC	141 -	09/01→06/05					
	147						
2.2 16V	108	09/00→06/05					
2.2 DTI 16V	86 -	01/02→06/05					
	92						
2.0 DI 16V	60	07/99→06/05		10/99→; - ABS		03.6583-0085.3 320238	ATE lastabhängig 8/3 4x
OPEL - ZAFIRA B Kasten/Großraumlimousine (A05) 07/05→04/15							
 Bremskraftverstärker							
1.6 CNG Turbo VAN	110	02/09→04/15		für Linkslenker; + ESP		03.7863-7803.4 300237	ATE Ø 10" pneumatisch
1.6 CNG VAN	69	07/05→04/15				03.7863-7803.4 300237	
1.7 CDTI VAN	81 -	01/08→04/15					
	92						
1.8 VAN	103	07/05→04/15					
1.9 CDTI VAN	88 -	07/05→04/15					
	110						
2.0 VAN	147	07/05→12/10					
2.2 DGi VAN	110	07/05→12/11					
 Hauptbremszylinder							
1.6 CNG Turbo VAN	110	02/09→04/15		für Linkslenker; - ESP		03.4155-0153.3 010927	ATE Ø 25,4
1.6 CNG VAN	69	07/05→04/15		für Linkslenker; + ESP		03.4155-0156.3 010862	ATE Ø 25,4
1.8 VAN	103	07/05→04/15		→ 6G999999; für Rechtslenker		24.2125-1736.3 010904	TRW Ø 25,4
1.9 CDTI VAN	88 -	07/05→04/15					
	110			72000001→; für Rechtslenker		24.4125-1703.3 010907	TRW Ø 25,4
2.0 VAN	147	07/05→12/10					
2.2 DGi VAN	110	07/05→12/11					
1.7 CDTI VAN	81 -	01/08→04/15		für Linkslenker; - ESP		03.4155-0153.3 010927	ATE Ø 25,4
	92			für Rechtslenker		03.4155-0156.3 010862	ATE Ø 25,4
				für Linkslenker; + ESP		03.4155-0156.3 010862	ATE Ø 25,4
OPEL - ZAFIRA TOURER C (P12) 10/11→							
 Bremskraftverstärker							
1.4	88 -	10/11→		11/11→; für Linkslenker		03.7858-0732.4 300272	ATE Ø 9 / 8" pneumatisch
	103					03.7858-0732.4 300272	
1.4 LPG	103	10/11→					
1.6 CNG	110	10/11→					
1.8	85 -	10/11→					
	103						
	81	10/11→					
2.0 CDTi	81	10/11→					
1.6	100 -	12/12→		für Linkslenker		03.7858-0732.4 300272	ATE Ø 9 / 8" pneumatisch
	125					03.7858-0732.4 300272	
1.6 CDTI	88 -	07/14→					
	99						
1.6 SIDI	147	07/13→					
2.0 BiTurbo CDTI	143	01/13→					
2.0 CDTi	96 -	10/11→					
	125						
1.6 CDTI	100	02/13→		03/13→; für Linkslenker		03.7858-0732.4 300272	ATE Ø 9 / 8" pneumatisch
→							

	kw					! #		
OPEL - ZAFIRA TOURER C (P12) 10/11→								
 Hauptbremszylinder								
1.4	88 - 103	10/11→		11/11→; für Linkslenker		03.2125-0421.3	010934	ATE Ø 25,4
1.4 LPG	103	10/11→		11/11→; für Rechtslenker		24.4155-0201.3	011125	ATE Ø 25,4 ohne Bremsflüssigkeitsbehälter
1.6 CNG	110	10/11→						
1.8	85 - 103	10/11→						
2.0 CDTi	81	10/11→						
1.6	100 - 125	12/12→		für Linkslenker		03.2125-0421.3	010934	ATE Ø 25,4
1.6 CDTi	88 - 99	07/14→		für Rechtslenker		24.4155-0201.3	011125	ATE Ø 25,4 ohne Bremsflüssigkeitsbehälter
1.6 SIDI	147	07/13→						
2.0 BiTurbo CDTi	143	01/13→						
2.0 CDTi	96 - 125	10/11→						
1.6 CDTi	100	02/13→		03/13→; für Linkslenker		03.2125-0421.3	010934	ATE Ø 25,4
				03/13→; für Rechtslenker		24.4155-0201.3	011125	ATE Ø 25,4 ohne Bremsflüssigkeitsbehälter
OPEL - ZAFIRA TOURER C VAN (P12) 10/11→								
 Bremskraftverstärker								
2.0 CDTi	81 - 121	01/12→		für Linkslenker		03.7858-0732.4	300272	ATE Ø 9 / 8" pneumatisch
 Hauptbremszylinder								
2.0 CDTi	81 - 121	01/12→		für Linkslenker		03.2125-0421.3	010934	ATE Ø 25,4
				für Rechtslenker		24.4155-0201.3	011125	ATE Ø 25,4 ohne Bremsflüssigkeitsbehälter
PEUGEOT - 106 II (1A_, 1C_) 04/96→05/05								
 Hauptbremszylinder								
1.0 i	33 - 37	04/96→03/01		→Orga 08787; - ABS		03.2120-4166.3	010452	ATE Ø 20,6
1.1 BiFuel	44	04/96→03/01				24.2120-1722.3	010544	Ø 20,6
1.1 i	40	01/97→03/01		Orga 08788→; - ABS		24.2119-1708.3	010543	BDX Ø 19
1.1 i	44	05/96→07/04		→Orga 08787; - ABS		03.2120-4166.3	010452	ATE Ø 20,6
						24.2120-1722.3	010544	Ø 20,6
				Orga 08788→; → 03/04; - ABS		24.2119-1708.3	010543	BDX Ø 19
1.4 i	55	05/96→07/04		→ 03/04; - ABS		24.2119-1708.3	010543	BDX Ø 19
1.5 D	40	05/96→03/01		- ABS		24.2119-1708.3	010543	BDX Ø 19
1.5 D	42	04/98→07/04		10/00→ 03/04; - ABS		24.2119-1708.3	010543	BDX Ø 19
1.6 i	65 - 74	05/96→01/01		- ABS		03.2120-4166.3	010452	ATE Ø 20,6
1.6 S16	88	04/98→09/01				24.2120-1722.3	010544	Ø 20,6
1.6 S16	87	05/96→07/04		→ 03/04; - ABS		03.2120-4166.3	010452	ATE Ø 20,6
						24.2120-1722.3	010544	Ø 20,6
Electric	20	04/96→07/04				03.2120-4166.3	010452	ATE Ø 20,6
						24.2120-1722.3	010544	Ø 20,6
PEUGEOT - 106 Van II Kasten/Schrägheck (1S_) 04/96→03/01								
 Hauptbremszylinder								
1.0	33	04/96→03/01		05/96→; →Orga 08787; - ABS		03.2120-4166.3	010452	ATE Ø 20,6
						24.2120-1722.3	010544	Ø 20,6
				Orga 08788→; - ABS		24.2119-1708.3	010543	BDX Ø 19
1.5 D	40 - 42	05/96→03/01		- ABS		24.2119-1708.3	010543	BDX Ø 19
Electric	20	04/96→03/01				03.2120-4166.3	010452	ATE Ø 20,6
						24.2120-1722.3	010544	Ø 20,6
PEUGEOT - 107 (PM_, PN_) 06/05→05/14								
 Hauptbremszylinder								
1.0	50	06/05→05/14		für Linkslenker; - DSC		24.4120-1701.3	010846	BOS Ø 20,6
1.4 HDi	40	06/05→05/14		für Linkslenker; + DSC		24.4120-1704.3	011042	Ø 20,6 ohne Bremsflüssigkeitsbehälter
				für Rechtslenker; + DSC		24.4120-1705.3	011051	Ø 20,6 ohne Bremsflüssigkeitsbehälter

	kw					! #		
PEUGEOT - 108 05/14→								
 Hauptbremszylinder								
1.0 VTi 1.0 VTi 72 1.2	51 53 60	05/14→ 05/18→ 05/14→			für Linkslenker; - ESP		24.4120-1712.3 011092	Ø 20,6 ohne Bremsflüssigkeitsbehälter
PEUGEOT - 206 CC (2D) 09/00→12/08								
 Bremskraftverstärker								
1.6 1.6 16V	81 80	09/01→12/08 09/00→12/07			→Orga 09820; - ABS; Schaltgetriebe	03.7750-6234.4 300320	ATE Ø 9" pneumatisch	
					Orga 09821→; → 01/07; - ABS; Schaltgetriebe	03.7750-6234.4 300320	ATE Ø 9" pneumatisch	
					→Orga 09456; + ABS; Schaltgetriebe	03.7750-6234.4 300320	ATE Ø 9" pneumatisch	
					Orga 09821→; → 01/07; - ABS; Automatikgetriebe	03.7750-6334.4 300321	ATE Ø 9" pneumatisch	
					→Orga 09456; + ABS; Automatikgetriebe	03.7750-6334.4 300321	ATE Ø 9" pneumatisch	
					→Orga 09820; - ABS; Automatikgetriebe	03.7750-6334.4 300321	ATE Ø 9" pneumatisch	
					Orga 09741→; → 01/07; + ABS; Schaltgetriebe	03.7853-2604.4 300322	ATE Ø 9" pneumatisch	
					09457→ 09740; + ABS; Schaltgetriebe	03.7853-2604.4 300322	ATE Ø 9" pneumatisch	
					Orga 09741→; → 01/07; Automatikgetriebe; + ABS	03.7853-2704.4 300323	ATE Ø 9" pneumatisch	
1.6 HDi 110	80	04/05→02/07			→ 01/07	03.7853-2604.4 300322 03.7853-2704.4 300323	ATE Ø 9" pneumatisch ATE Ø 9" pneumatisch	
 Hauptbremszylinder								
1.6 1.6 16V	81 80	09/01→12/08 09/00→12/07			→ 01/07; Schaltgetriebe; - ESP	03.2122-1351.3 010528	Ø 22,2	
					→ 01/07; Schaltgetriebe; - ABS	03.2122-1356.3 010529	Ø 22,2	
					→ 01/07; Schaltgetriebe; + ESP	03.2122-1942.3 010700	ATE Ø 22,2	
					→ 01/07; Automatikgetriebe; - ABS	03.4122-0031.3 010611	ATE Ø 22,2	
					→ 01/07; Automatikgetriebe; - ESP	03.4122-0041.3 010612	ATE Ø 22,2	
					→ 01/07; Automatikgetriebe; + ESP	03.4122-0054.3 010813	ATE Ø 22,2	
1.6 HDi 110	80	04/05→02/07			→ 01/07; - ESP	03.2122-1351.3 010528 03.4122-0041.3 010612	Ø 22,2 ATE Ø 22,2	
					→ 01/07; + ESP	03.2122-1942.3 010700 03.4122-0054.3 010813	ATE Ø 22,2 ATE Ø 22,2	
2.0 S16	100	09/00→12/07			→ 01/07; - ESP	03.2122-1351.3 010528	Ø 22,2	
					→ 01/07; + ESP	03.2122-1942.3 010700	ATE Ø 22,2	
PEUGEOT - 206 Schrägheck (2A/C) 08/98→12/12								
 Bremskraftverstärker								
1.0 1.1 i	52 44	06/01→12/05 09/98→02/07			→Orga 09456; + ABS	03.7750-6234.4 300320	ATE Ø 9" pneumatisch	
					Orga 09741→; + ABS	03.7853-2604.4 300322	ATE Ø 9" pneumatisch	
					09457→ 09740; + ABS	03.7853-2604.4 300322	ATE Ø 9" pneumatisch	
1.1	40	08/98→07/00			09/98→; →Orga 09456; + ABS	03.7750-6234.4 300320	ATE Ø 9" pneumatisch	
					Orga 09741→; + ABS	03.7853-2604.4 300322	ATE Ø 9" pneumatisch	
					09457→ 09740; + ABS	03.7853-2604.4 300322	ATE Ø 9" pneumatisch	
1.4 16V	65	10/03→02/08			- ABS	03.7750-6234.4 300320 03.7853-2604.4 300322	ATE Ø 9" pneumatisch ATE Ø 9" pneumatisch	
1.4 CNG 1.4 LPG	55 55	05/06→09/07 05/06→09/07			- ABS; Schaltgetriebe	03.7750-6134.4 300319	ATE Ø 9" pneumatisch	
					- ABS; Automatikgetriebe	03.7750-6334.4 300321	ATE Ø 9" pneumatisch	
					+ ABS; Schaltgetriebe	03.7853-2604.4 300322	ATE Ø 9" pneumatisch	
					+ ABS; Automatikgetriebe	03.7853-2704.4 300323	ATE Ø 9" pneumatisch	
1.4 Flex 1.4 i	60 55	01/06→11/09 09/98→12/12			→Orga 09820; Schaltgetriebe; - ABS	03.7750-6134.4 300319	ATE Ø 9" pneumatisch	
					→Orga 09456; Schaltgetriebe; + ABS	03.7750-6234.4 300320	ATE Ø 9" pneumatisch	
					→Orga 09820; Automatikgetriebe; - ABS	03.7750-6334.4 300321	ATE Ø 9" pneumatisch	
					→Orga 09456; Automatikgetriebe; + ABS	03.7750-6334.4 300321	ATE Ø 9" pneumatisch	
					Orga 09821→; → 02/09; Automatikgetriebe; - ABS	03.7750-6334.4 300321	ATE Ø 9" pneumatisch	
					09457→ 09740; Schaltgetriebe; + ABS	03.7853-2604.4 300322	ATE Ø 9" pneumatisch	
					Orga 09741→; → 02/09; Schaltgetriebe	03.7853-2604.4 300322	ATE Ø 9" pneumatisch	
					Orga 09741→; → 02/09; Automatikgetriebe	03.7853-2704.4 300323	ATE Ø 9" pneumatisch	
1.4 HDi	51	09/02→02/07			→Orga 09820; - ABS	03.7750-6134.4 300319	ATE Ø 9" pneumatisch	
					→Orga 09456; + ABS	03.7750-6234.4 300320	ATE Ø 9" pneumatisch	
					Orga 09821→	03.7853-2604.4 300322	ATE Ø 9" pneumatisch	
→								







PEUGEOT - 206 Schrägheck (2A/C) 08/98→12/12











Bremskraftverstärker











1.4 HDi	51	09/02→02/07		09457→ 09740; + ABS	03.7853-2604.4	300322	ATE Ø 9" pneumatisch
1.4 HDi eco 70	50	09/01→04/09		→Orga 09820; - ABS	03.7750-6134.4	300319	ATE Ø 9" pneumatisch
				→Orga 09456; + ABS	03.7750-6234.4	300320	ATE Ø 9" pneumatisch
				Orga 09821→; → 02/09	03.7853-2604.4	300322	ATE Ø 9" pneumatisch
				09457→ 09740; + ABS	03.7853-2604.4	300322	ATE Ø 9" pneumatisch
1.6 1.6 16V	81	05/05→07/08		→Orga 09456; Schaltgetriebe; + ABS	03.7750-6234.4	300320	ATE Ø 9" pneumatisch
	79 - 80	07/00→04/09		09821→ 10996; - ABS; Schaltgetriebe	03.7750-6234.4	300320	ATE Ø 9" pneumatisch
1.6 BiFuel 1.6 Flex	80	07/00→04/09		→Orga 09820; Schaltgetriebe; + ABS	03.7750-6234.4	300320	ATE Ø 9" pneumatisch
	83	05/05→07/08		→Orga 09456; Automatikgetriebe; + ABS	03.7750-6334.4	300321	ATE Ø 9" pneumatisch
				→Orga 09820; Automatikgetriebe; - ABS	03.7750-6334.4	300321	ATE Ø 9" pneumatisch
				09821→ 10996; Automatikgetriebe; - ABS	03.7750-6334.4	300321	ATE Ø 9" pneumatisch
				09741→ 10996; Schaltgetriebe	03.7853-2604.4	300322	ATE Ø 9" pneumatisch
				09457→ 09740; Schaltgetriebe; + ABS	03.7853-2604.4	300322	ATE Ø 9" pneumatisch
1.6 8V	66	05/99→10/03		→ 12/00; Schaltgetriebe; - ABS	03.7750-6134.4	300319	ATE Ø 9" pneumatisch
				→ 12/00; Schaltgetriebe; + ABS	03.7750-6234.4	300320	ATE Ø 9" pneumatisch
				→ 12/00; Automatikgetriebe	03.7750-6334.4	300321	ATE Ø 9" pneumatisch
1.6 HDi 110	80	05/04→02/07			03.7853-2604.4	300322	ATE Ø 9" pneumatisch
				+ ABS	03.7853-2704.4	300323	ATE Ø 9" pneumatisch
1.6 i	65	09/98→12/00		- ABS; Schaltgetriebe	03.7750-6134.4	300319	ATE Ø 9" pneumatisch
				Schaltgetriebe; + ABS	03.7750-6234.4	300320	ATE Ø 9" pneumatisch
				Automatikgetriebe	03.7750-6334.4	300321	ATE Ø 9" pneumatisch
1.9 D	51	09/98→11/01			03.7750-6134.4	300319	ATE Ø 9" pneumatisch
				→Orga 09456; + ABS	03.7750-6234.4	300320	ATE Ø 9" pneumatisch
				Orga 09457→; + ABS	03.7750-6334.4	300321	ATE Ø 9" pneumatisch
2.0 HDi 90	66	12/99→09/09		→Orga 09456	03.7750-6234.4	300320	ATE Ø 9" pneumatisch
				→Orga 09820	03.7750-6334.4	300321	ATE Ø 9" pneumatisch
				Orga 09821→; → 02/09	03.7750-6234.4	300320	ATE Ø 9" pneumatisch
				Orga 09821→; → 02/09	03.7750-6334.4	300321	ATE Ø 9" pneumatisch
				09457→ 09820; + ABS	03.7853-2604.4	300322	ATE Ø 9" pneumatisch
				Orga 09821→; → 02/09; + ABS	03.7853-2604.4	300322	ATE Ø 9" pneumatisch
				03.7853-2704.4	300323	ATE Ø 9" pneumatisch	













Hauptbremszylinder

















1.0 1.1 i	52	06/01→12/05		- ABS	03.2120-4321.3	010525	ATE Ø 20,6
	44	09/98→02/07		+ ABS	03.2122-1351.3	010528	Ø 22,2
1.1	40	08/98→07/00			24.2120-1737.3	010757	Ø 20,6
				09/98→; - ABS	03.2120-4321.3	010525	ATE Ø 20,6
				09/98→; + ABS	03.2122-1351.3	010528	Ø 22,2
1.4 16V	65	10/03→02/08		09/98→	24.2120-1737.3	010757	Ø 20,6
				- ESP	03.2122-1351.3	010528	Ø 22,2
				- ABS	03.2122-1356.3	010529	Ø 22,2
			+ ESP	03.2122-1942.3	010700	ATE Ø 22,2	
1.4 CNG 1.4 Flex	55	05/06→09/07		Schaltgetriebe; - ABS	03.2120-4321.3	010525	ATE Ø 20,6
	60	01/06→11/09		Schaltgetriebe; + ABS	03.2122-1351.3	010528	Ø 22,2
1.4 LPG 1.6 i	55	05/06→09/07		Automatikgetriebe; - ABS	03.4122-0031.3	010611	ATE Ø 22,2
	65	09/98→12/00		Automatikgetriebe; + ABS	03.4122-0041.3	010612	ATE Ø 22,2
				Schaltgetriebe	24.2120-1737.3	010757	Ø 20,6
1.4 HDi	51	09/02→02/07		- ABS	03.2120-4321.3	010525	ATE Ø 20,6
				- ESP	03.2122-1351.3	010528	Ø 22,2
				+ ESP	03.2122-1942.3	010700	ATE Ø 22,2
					24.2120-1737.3	010757	Ø 20,6
1.4 HDi eco 70	50	09/01→04/09		→ 02/09; - ABS	03.2120-4321.3	010525	ATE Ø 20,6
				→ 02/09; - ESP	03.2122-1351.3	010528	Ø 22,2
				→ 02/09; + ESP	03.2122-1942.3	010700	ATE Ø 22,2
→							











	kw					! #		
PEUGEOT - 206 Schrägheck (2A/C) 08/98→12/12								
Hauptbremszylinder								
1.4 HDi eco 70	50	09/01→04/09		→ 02/09			24.2120-1737.3 010757	Ø 20,6
1.4 i	55	09/98→12/12		→ 02/09; Schaltgetriebe; - ABS			03.2120-4321.3 010525	ATE Ø 20,6
				→ 02/09; Schaltgetriebe; + ABS			03.2122-1351.3 010528	Ø 22,2
				→ 02/09; Automatikgetriebe; - ABS			03.4122-0031.3 010611	ATE Ø 22,2
				→ 02/09; Automatikgetriebe; + ABS			03.4122-0041.3 010612	ATE Ø 22,2
				→ 02/09; Schaltgetriebe			24.2120-1737.3 010757	Ø 20,6
1.6 1.6 16V 1.6 Flex	81 79 83	05/05→07/08 06/01→04/09 05/05→07/08		Schaltgetriebe; + ABS			03.2122-1351.3 010528	Ø 22,2
				Schaltgetriebe; - ESP			03.2122-1351.3 010528	Ø 22,2
				Schaltgetriebe; - ABS			03.2122-1356.3 010529	Ø 22,2
				Schaltgetriebe; + ESP			03.2122-1942.3 010700	ATE Ø 22,2
				Automatikgetriebe; - ABS			03.4122-0031.3 010611	ATE Ø 22,2
				Automatikgetriebe; - ESP			03.4122-0041.3 010612	ATE Ø 22,2
				Automatikgetriebe; + ESP			03.4122-0054.3 010813	ATE Ø 22,2
1.6 16V 1.6 BiFuel	80 80	07/00→04/09 07/00→04/09		→ 02/09; Schaltgetriebe; + ABS			03.2122-1351.3 010528	Ø 22,2
				→ 02/09; Schaltgetriebe; - ESP			03.2122-1351.3 010528	Ø 22,2
				→ 02/09; Schaltgetriebe; - ABS			03.2122-1356.3 010529	Ø 22,2
				→ 02/09; Schaltgetriebe; + ESP			03.2122-1942.3 010700	ATE Ø 22,2
				→ 02/09; Automatikgetriebe; - ABS			03.4122-0031.3 010611	ATE Ø 22,2
				→ 02/09; Automatikgetriebe; - ESP			03.4122-0041.3 010612	ATE Ø 22,2
				→ 02/09; Automatikgetriebe; + ESP			03.4122-0054.3 010813	ATE Ø 22,2
1.6 8V	66	05/99→10/03		→ 12/00; Schaltgetriebe; - ABS			03.2120-4321.3 010525	ATE Ø 20,6
				→ 12/00; Schaltgetriebe; + ABS			03.2122-1351.3 010528	Ø 22,2
				→ 12/00; Automatikgetriebe; - ABS			03.4122-0031.3 010611	ATE Ø 22,2
				→ 12/00; Automatikgetriebe; + ABS			03.4122-0041.3 010612	ATE Ø 22,2
				→ 12/00; Schaltgetriebe			24.2120-1737.3 010757	Ø 20,6
1.6 HDi 110	80	05/04→02/07		- ESP			03.2122-1351.3 010528	Ø 22,2
				+ ESP			03.4122-0041.3 010612	ATE Ø 22,2
							03.4122-0054.3 010813	ATE Ø 22,2
1.9 D	51	09/98→11/01		- ABS			03.2120-4321.3 010525	ATE Ø 20,6
				+ ABS			03.4122-0031.3 010611	ATE Ø 22,2
							24.2120-1737.3 010757	Ø 20,6
							03.4122-0041.3 010612	ATE Ø 22,2
2.0 HDi 90	66	12/99→09/09		→ 02/09; - ESP			03.2122-1351.3 010528	Ø 22,2
				→ 02/09; - ABS			03.4122-0041.3 010612	ATE Ø 22,2
				→ 02/09; - ABS			03.2122-1356.3 010529	Ø 22,2
				→ 02/09; + ESP			03.4122-0031.3 010611	ATE Ø 22,2
				→ 02/09; + ABS			03.4122-0054.3 010813	ATE Ø 22,2
2.0 RC	130	07/03→12/07				03.2122-1942.3 010700	ATE Ø 22,2	
2.0 S16	99	04/99→10/00		- ESP			03.2122-1351.3 010528	Ø 22,2
				+ ESP			03.2122-1942.3 010700	ATE Ø 22,2
2.0 S16	100	06/99→12/07		10/00→ 02/07; - ESP			03.2122-1351.3 010528	Ø 22,2
				10/00→ 02/07; + ESP			03.2122-1942.3 010700	ATE Ø 22,2
PEUGEOT - 206 Stufenheck 03/07→								
Bremskraftverstärker								
1.4	55	03/07→		→ 02/09; - ABS; Schaltgetriebe			03.7750-6134.4 300319	ATE Ø 9" pneumatisch
				→ 02/09; - ABS; Automatikgetriebe			03.7750-6334.4 300321	ATE Ø 9" pneumatisch
				→ 02/09; + ABS; Schaltgetriebe			03.7853-2604.4 300322	ATE Ø 9" pneumatisch
				→ 02/09; + ABS; Automatikgetriebe			03.7853-2704.4 300323	ATE Ø 9" pneumatisch
1.4 HDi eco 70	50	09/08→		→ 02/09			03.7853-2604.4 300322	ATE Ø 9" pneumatisch
1.6 16V	80	03/07→		→Orga 09456; Schaltgetriebe; + ABS			03.7750-6234.4 300320	ATE Ø 9" pneumatisch
				09821→ 10996; - ABS; Schaltgetriebe			03.7750-6234.4 300320	ATE Ø 9" pneumatisch
				→Orga 09820; Schaltgetriebe; + ABS			03.7750-6234.4 300320	ATE Ø 9" pneumatisch
				→Orga 09456; Automatikgetriebe; + ABS			03.7750-6334.4 300321	ATE Ø 9" pneumatisch
				→Orga 09820; Automatikgetriebe; - ABS			03.7750-6334.4 300321	ATE Ø 9" pneumatisch
				09821→ 10996; Automatikgetriebe; - ABS			03.7750-6334.4 300321	ATE Ø 9" pneumatisch
→								









	kw			 	! #		
PEUGEOT - 206 Stufenheck 03/07→							
 Bremskraftverstärker							
1.6 16V	80	03/07→		09741→ 10996; Schaltgetriebe	03.7853-2604.4	300322	ATE Ø 9" pneumatisch
				09457→ 09740; Schaltgetriebe; + ABS	03.7853-2604.4	300322	ATE Ø 9" pneumatisch
				09741→ 10996; Automatikgetriebe; + ABS	03.7853-2704.4	300323	ATE Ø 9" pneumatisch
 Hauptbremszylinder							
1.4	55	03/07→		→ 02/09; Schaltgetriebe; - ABS	03.2120-4321.3	010525	ATE Ø 20,6
				→ 02/09; Schaltgetriebe; + ABS	03.2122-1351.3	010528	Ø 22,2
				→ 02/09; Automatikgetriebe; - ABS	03.4122-0031.3	010611	ATE Ø 22,2
				→ 02/09; Automatikgetriebe; + ABS	03.4122-0041.3	010612	ATE Ø 22,2
				→ 02/09; Schaltgetriebe	24.2120-1737.3	010757	Ø 20,6
1.4 HDi eco 70	50	09/08→		→ 02/09; - ABS	03.2120-4321.3	010525	ATE Ø 20,6
				→ 02/09; - ESP	03.2122-1351.3	010528	Ø 22,2
				→ 02/09; + ABS	03.2122-1351.3	010528	Ø 22,2
				→ 02/09; + ESP	03.2122-1942.3	010700	ATE Ø 22,2
				→ 02/09	24.2120-1737.3	010757	Ø 20,6
1.6 16V	80	03/07→		→ 02/09; Schaltgetriebe; + ABS	03.2122-1351.3	010528	Ø 22,2
				→ 02/09; Schaltgetriebe; - ESP	03.2122-1351.3	010528	Ø 22,2
				→ 02/09; Schaltgetriebe; - ABS	03.2122-1356.3	010529	Ø 22,2
				→ 02/09; Schaltgetriebe; + ESP	03.2122-1942.3	010700	ATE Ø 22,2
				→ 02/09; Automatikgetriebe; - ABS	03.4122-0031.3	010611	ATE Ø 22,2
				→ 02/09; Automatikgetriebe; - ESP	03.4122-0041.3	010612	ATE Ø 22,2
				→ 02/09; Automatikgetriebe; + ESP	03.4122-0054.3	010813	ATE Ø 22,2
PEUGEOT - 206 SW (2E/K) 07/02→							
 Bremskraftverstärker							
1.1	44	07/02→02/07		→Orga 09456; + ABS	03.7750-6234.4	300320	ATE Ø 9" pneumatisch
				Orga 09741→; + ABS	03.7853-2604.4	300322	ATE Ø 9" pneumatisch
				09457→ 09740; + ABS	03.7853-2604.4	300322	ATE Ø 9" pneumatisch
1.4 1.4 Flex 1.4 LPG	55	07/02→02/07		→Orga 09820; Schaltgetriebe; - ABS	03.7750-6134.4	300319	ATE Ø 9" pneumatisch
				→Orga 09456; Schaltgetriebe; + ABS	03.7750-6234.4	300320	ATE Ø 9" pneumatisch
				→Orga 09820; - ABS; Automatikgetriebe	03.7750-6334.4	300321	ATE Ø 9" pneumatisch
				→Orga 09456; + ABS; Automatikgetriebe	03.7750-6334.4	300321	ATE Ø 9" pneumatisch
				Orga 09821→; - ABS; Automatikgetriebe	03.7750-6334.4	300321	ATE Ø 9" pneumatisch
				09457→ 09740; Schaltgetriebe; + ABS	03.7853-2604.4	300322	ATE Ø 9" pneumatisch
				Orga 09741→; + ABS; Schaltgetriebe	03.7853-2604.4	300322	ATE Ø 9" pneumatisch
				Orga 09741→; + ABS; Automatikgetriebe	03.7853-2704.4	300323	ATE Ø 9" pneumatisch
1.4 16V	65	10/03→		→ 05/07; - ABS	03.7750-6134.4	300319	ATE Ø 9" pneumatisch
				→ 05/07; + ABS	03.7853-2604.4	300322	ATE Ø 9" pneumatisch
1.4 HDi	50	07/02→02/07		→Orga 09820; - ABS	03.7750-6134.4	300319	ATE Ø 9" pneumatisch
				→Orga 09456; + ABS	03.7750-6234.4	300320	ATE Ø 9" pneumatisch
				09457→ 09820; + ABS	03.7853-2604.4	300322	ATE Ø 9" pneumatisch
				Orga 09821→; + ABS	03.7853-2604.4	300322	ATE Ø 9" pneumatisch
1.6 1.6 16V	81 80	05/05→07/08 07/02→		→Orga 09820; Schaltgetriebe; + ABS	03.7750-6234.4	300320	ATE Ø 9" pneumatisch
				Orga 09821→; → 05/07; Schaltgetriebe; - ABS	03.7750-6234.4	300320	ATE Ø 9" pneumatisch
				→Orga 09456; Schaltgetriebe; + ABS	03.7750-6234.4	300320	ATE Ø 9" pneumatisch
				Orga 09821→; → 05/07; - ABS; Automatikgetriebe	03.7750-6334.4	300321	ATE Ø 9" pneumatisch
				→Orga 09820; - ABS; Automatikgetriebe	03.7750-6334.4	300321	ATE Ø 9" pneumatisch
				→Orga 09456; + ABS; Automatikgetriebe	03.7750-6334.4	300321	ATE Ø 9" pneumatisch
				Orga 09741→; → 05/07; + ABS; Schaltgetriebe	03.7853-2604.4	300322	ATE Ø 9" pneumatisch
				09457→ 09740; Schaltgetriebe; + ABS	03.7853-2604.4	300322	ATE Ø 9" pneumatisch
				Orga 09741→; → 05/07; + ABS; Automatikgetriebe	03.7853-2704.4	300323	ATE Ø 9" pneumatisch
			1.6 Flex 1.6 LPG	81 - 83 80	05/05→07/08 07/02→02/07		→Orga 09820; Schaltgetriebe; + ABS
	Orga 09821→; Schaltgetriebe; - ABS	03.7750-6234.4				300320	ATE Ø 9" pneumatisch
	→Orga 09456; Schaltgetriebe; + ABS	03.7750-6234.4				300320	ATE Ø 9" pneumatisch
	→Orga 09820; - ABS; Automatikgetriebe	03.7750-6334.4				300321	ATE Ø 9" pneumatisch
	→Orga 09456; + ABS; Automatikgetriebe	03.7750-6334.4				300321	ATE Ø 9" pneumatisch
	Orga 09821→; - ABS; Automatikgetriebe	03.7750-6334.4				300321	ATE Ø 9" pneumatisch
→							









	kw			 	! #		
PEUGEOT - 206 SW (2E/K) 07/02→							
 Bremskraftverstärker							
1.6 Flex	81 - 83	05/05→07/08		09457→ 09740; Schaltgetriebe; + ABS	03.7853-2604.4	300322	ATE Ø 9" pneumatisch
1.6 LPG	80	07/02→02/07		Orga 09741→; + ABS; Schaltgetriebe	03.7853-2604.4	300322	ATE Ø 9" pneumatisch
				Orga 09741→; + ABS; Automatikgetriebe	03.7853-2704.4	300323	ATE Ø 9" pneumatisch
1.6 HDi 110	80	05/04→		→ 05/07; + ABS	03.7853-2604.4	300322	ATE Ø 9" pneumatisch
					03.7853-2704.4	300323	ATE Ø 9" pneumatisch
2.0 HDi	66	07/02→02/07		→Orga 09456; + ABS	03.7750-6234.4	300320	ATE Ø 9" pneumatisch
				Orga 09821→; - ABS	03.7750-6234.4	300320	ATE Ø 9" pneumatisch
				→Orga 09820; - ABS	03.7750-6234.4	300320	ATE Ø 9" pneumatisch
					03.7750-6334.4	300321	ATE Ø 9" pneumatisch
				09457→ 09820; + ABS	03.7853-2604.4	300322	ATE Ø 9" pneumatisch
				Orga 09821→; + ABS	03.7853-2604.4	300322	ATE Ø 9" pneumatisch
					03.7853-2704.4	300323	ATE Ø 9" pneumatisch
 Hauptbremszylinder							
1.1	44	07/02→02/07		- ABS	03.2120-4321.3	010525	ATE Ø 20,6
				+ ABS	24.2120-1737.3	010757	Ø 20,6
					03.2122-1351.3	010528	Ø 22,2
1.4	55	07/02→02/07		Schaltgetriebe; - ABS	03.2120-4321.3	010525	ATE Ø 20,6
1.4 Flex	59	01/06→07/08			24.2120-1737.3	010757	Ø 20,6
1.4 LPG	55	07/02→02/07		Schaltgetriebe; + ABS	03.2122-1351.3	010528	Ø 22,2
				Automatikgetriebe; - ABS	03.4122-0031.3	010611	ATE Ø 22,2
				Automatikgetriebe; - ESP	03.4122-0041.3	010612	ATE Ø 22,2
				Automatikgetriebe; + ESP	03.4122-0054.3	010813	ATE Ø 22,2
1.4 16V	65	10/03→		→ 05/07; - ESP	03.2122-1351.3	010528	Ø 22,2
				→ 05/07; - ABS	03.2122-1356.3	010529	Ø 22,2
				→ 05/07; + ESP	03.2122-1942.3	010700	ATE Ø 22,2
1.4 HDi	50	07/02→02/07		- ABS	03.2120-4321.3	010525	ATE Ø 20,6
				- ESP	24.2120-1737.3	010757	Ø 20,6
				+ ESP	03.2122-1351.3	010528	Ø 22,2
					03.2122-1942.3	010700	ATE Ø 22,2
1.6	81	05/05→07/08		→ 05/07; Schaltgetriebe; - ESP	03.2122-1351.3	010528	Ø 22,2
1.6 16V	80	07/02→		→ 05/07; Schaltgetriebe; - ABS	03.2122-1356.3	010529	Ø 22,2
				→ 05/07; Schaltgetriebe; + ESP	03.2122-1942.3	010700	ATE Ø 22,2
				→ 05/07; Automatikgetriebe; - ABS	03.4122-0031.3	010611	ATE Ø 22,2
				→ 05/07; Automatikgetriebe; - ESP	03.4122-0041.3	010612	ATE Ø 22,2
				→ 05/07; Automatikgetriebe; + ESP	03.4122-0054.3	010813	ATE Ø 22,2
1.6 Flex	81 - 83	05/05→07/08		Schaltgetriebe; - ESP	03.2122-1351.3	010528	Ø 22,2
1.6 LPG	80	07/02→02/07		Schaltgetriebe; - ABS	03.2122-1356.3	010529	Ø 22,2
				Schaltgetriebe; + ESP	03.2122-1942.3	010700	ATE Ø 22,2
				Automatikgetriebe; - ABS	03.4122-0031.3	010611	ATE Ø 22,2
				Automatikgetriebe; - ESP	03.4122-0041.3	010612	ATE Ø 22,2
				Automatikgetriebe; + ESP	03.4122-0054.3	010813	ATE Ø 22,2
1.6 HDi 110	80	05/04→		→ 05/07; - ESP	03.2122-1351.3	010528	Ø 22,2
					03.4122-0041.3	010612	ATE Ø 22,2
				→ 05/07; + ESP	03.2122-1942.3	010700	ATE Ø 22,2
					03.4122-0054.3	010813	ATE Ø 22,2
2.0 16V	100	07/02→02/07		- ESP	03.2122-1351.3	010528	Ø 22,2
				+ ESP	03.2122-1942.3	010700	ATE Ø 22,2
2.0 HDi	66	07/02→02/07		- ESP	03.2122-1351.3	010528	Ø 22,2
					03.4122-0041.3	010612	ATE Ø 22,2
				- ABS	03.2122-1356.3	010529	Ø 22,2
					03.4122-0031.3	010611	ATE Ø 22,2
				+ ESP	03.2122-1942.3	010700	ATE Ø 22,2
					03.4122-0054.3	010813	ATE Ø 22,2
PEUGEOT - 206 Van 04/99→03/09							
 Bremskraftverstärker							
1.1	44	09/02→02/07		→Orga 09456; + ABS	03.7750-6234.4	300320	ATE Ø 9" pneumatisch
				Orga 09741→; + ABS	03.7853-2604.4	300322	ATE Ø 9" pneumatisch
→							

	kw					! #		
PEUGEOT - 206 Van 04/99→03/09								
 Bremskraftverstärker								
1.1	44	09/02→02/07		09457→ 09740; + ABS		03.7853-2604.4	300322	ATE Ø 9" pneumatisch
1.4 HDi	50	09/01→03/09		→Orga 09820; - ABS		03.7750-6134.4	300319	ATE Ø 9" pneumatisch
				→Orga 09456; + ABS		03.7750-6234.4	300320	ATE Ø 9" pneumatisch
				Orga 09821→; → 02/09		03.7853-2604.4	300322	ATE Ø 9" pneumatisch
				09457→ 09740; + ABS		03.7853-2604.4	300322	ATE Ø 9" pneumatisch
1.9 D	51	04/99→05/07				03.7750-6134.4	300319	ATE Ø 9" pneumatisch
						03.7750-6334.4	300321	ATE Ø 9" pneumatisch
				→Orga 09456; + ABS		03.7750-6234.4	300320	ATE Ø 9" pneumatisch
				Orga 09457→; + ABS		03.7750-6334.4	300321	ATE Ø 9" pneumatisch
				Orga 09457→; + ABS		03.7853-2604.4	300322	ATE Ø 9" pneumatisch
 Hauptbremszylinder								
1.1	44	09/02→02/07		- ABS		03.2120-4321.3	010525	ATE Ø 20,6
				+ ABS		03.2122-1351.3	010528	Ø 22,2
						24.2120-1737.3	010757	Ø 20,6
1.4 HDi	50	09/01→03/09		→ 02/09; - ABS		03.2120-4321.3	010525	ATE Ø 20,6
				→ 02/09; - ESP		03.2122-1351.3	010528	Ø 22,2
				→ 02/09; + ESP		03.2122-1942.3	010700	ATE Ø 22,2
				→ 02/09		24.2120-1737.3	010757	Ø 20,6
1.9 D	51	04/99→05/07		- ABS		03.2120-4321.3	010525	ATE Ø 20,6
						03.4122-0031.3	010611	ATE Ø 22,2
				+ ABS		03.2122-1351.3	010528	Ø 22,2
						03.4122-0041.3	010612	ATE Ø 22,2
						24.2120-1737.3	010757	Ø 20,6
PEUGEOT - 206+ (2L_, 2M_) 01/09→08/13								
 Bremskraftverstärker								
1.1	44	01/09→06/13		→ 05/13; - ABS		03.7750-6134.4	300319	ATE Ø 9" pneumatisch
1.1 LPG	44	04/09→06/13						
1.4 HDi eco 70	50	01/09→06/13		→ 05/13; + ABS		03.7853-2604.4	300322	ATE Ø 9" pneumatisch
1.4 i	54 - 55	01/09→08/13						
 Hauptbremszylinder								
1.1	44	01/09→06/13		→ 05/13; - ABS		03.2120-4321.3	010525	ATE Ø 20,6
						24.2120-1737.3	010757	Ø 20,6
1.1 LPG	44	04/09→06/13						
1.4 HDi eco 70	50	01/09→06/13						
1.4 i	54 - 55	01/09→08/13		→ 05/13; + ABS		03.2122-1351.3	010528	Ø 22,2
				→ 05/13; + ESP		03.2122-1942.3	010700	ATE Ø 22,2
PEUGEOT - 207 (WA_, WC_) 02/06→12/15								
 Bremskraftverstärker								
2.0 HDi	66	10/08→12/12		+ ABS		03.7853-2604.4	300322	ATE Ø 9" pneumatisch
 Hauptbremszylinder								
1.4	54 - 55	04/06→12/15		→ 06/12; + ESP		24.4122-1703.3	010843	TRW Ø 22,2
1.4 16V	65 - 72	02/06→10/13		→ 06/12; - ESP		24.4122-1704.3	010847	TRW Ø 22,2
1.4 Bioflex	60	08/08→12/14						
1.4 HDi	50 - 52	02/06→12/15						
1.6	81	08/08→12/13						
1.6 16V	79 - 80	02/06→12/13						
1.6 Flex	83	08/08→12/13						
1.6 HDi	66	02/06→10/13						
1.4 16V	70	06/07→10/13		08/07→ 06/12; + ESP		24.4122-1703.3	010843	TRW Ø 22,2
				08/07→ 06/12; - ESP		24.4122-1704.3	010847	TRW Ø 22,2
1.4 BiFuel	54	08/07→12/13		+ ESP		24.4122-1703.3	010843	TRW Ø 22,2
				- ESP		24.4122-1704.3	010847	TRW Ø 22,2
1.6 16V RC	128	02/07→12/12		→ 06/12; + ESP		24.4123-1704.3	010828	TRW Ø 23,8
1.6 16V Turbo	110	02/06→10/13						
1.6 16V VTi	88	02/07→12/12		→ 06/12; - ESP		24.4123-1705.3	010832	TRW Ø 23,8
1.6 HDi	68 - 80	02/06→10/13						
1.6 HDi 110	82	08/09→12/12						
1.6 16V Turbo	115	10/09→12/12		01/10→ 06/12; + ESP		24.4123-1704.3	010828	TRW Ø 23,8
→								













	kw					! #		
PEUGEOT - 207 (WA_, WC_) 02/06→12/15								
 Hauptbremszylinder								
1.6 16V Turbo	115	10/09→12/12		01/10→06/12; - ESP		24.4123-1705.3 010832	TRW Ø 23,8	
1.6 16V VTi	81	09/08→12/12		+ ESP		24.4123-1704.3 010828	TRW Ø 23,8	
				- ESP		24.4123-1705.3 010832	TRW Ø 23,8	
2.0 HDi	66	10/08→12/12		+ ABS		03.2122-1351.3 010528	Ø 22,2	
PEUGEOT - 207 CC (WD_) 02/07→01/15								
 Hauptbremszylinder								
1.6 16V	88	02/07→10/13		+ ESP		24.4123-1704.3 010828	TRW Ø 23,8	
1.6 16V Turbo	110 - 115	02/07→12/13		- ESP		24.4123-1705.3 010832	TRW Ø 23,8	
1.6 HDi	80 - 82	02/07→01/15						
PEUGEOT - 207 Kasten/Schrägheck (WA_, WC_) 04/06→								
 Hauptbremszylinder								
1.4	54	06/07→10/08		+ ESP		24.4122-1703.3 010843	TRW Ø 22,2	
				- ESP		24.4122-1704.3 010847	TRW Ø 22,2	
1.4 HDi	50	04/07→		→ 06/12; + ESP		24.4122-1703.3 010843	TRW Ø 22,2	
1.6 HDi	66 - 68	04/07→03/13		→ 06/12; - ESP		24.4122-1704.3 010847	TRW Ø 22,2	
1.6 HDi	80	04/06→12/12		+ ESP		24.4123-1704.3 010828	TRW Ø 23,8	
1.6 VTi	88	03/07→12/12		- ESP		24.4123-1705.3 010832	TRW Ø 23,8	
PEUGEOT - 207 Stufenheck 12/07→12/14								
 Bremskraftverstärker								
2.0 HDi	66	12/07→12/12		+ ABS		03.7853-2604.4 300322	ATE Ø 9" pneumatisch	
 Hauptbremszylinder								
1.4	54 - 55	12/07→12/12		→ 06/12; + ESP		24.4122-1703.3 010843	TRW Ø 22,2	
1.4 Flex	60	11/08→12/14		→ 06/12; - ESP		24.4122-1704.3 010847	TRW Ø 22,2	
1.6 Bioflex	83	01/08→12/13						
2.0 HDi	66	12/07→12/12		+ ABS		03.2122-1351.3 010528	Ø 22,2	
PEUGEOT - 207 SW (WK_) 02/07→12/13								
 Bremskraftverstärker								
2.0 HDi	66	10/08→12/12		+ ABS		03.7853-2604.4 300322	ATE Ø 9" pneumatisch	
 Hauptbremszylinder								
1.4	54	06/07→12/12		+ ESP		24.4122-1703.3 010843	TRW Ø 22,2	
1.4 16V	72	11/09→12/12		- ESP		24.4122-1704.3 010847	TRW Ø 22,2	
1.4 Flex	59	08/08→01/13						
1.4 LPG	54	08/07→12/12						
1.4 16V	70	06/07→10/13		→ 07/13; + ESP		24.4122-1703.3 010843	TRW Ø 22,2	
				→ 07/13; - ESP		24.4122-1704.3 010847	TRW Ø 22,2	
1.6	81	08/08→12/12		→ 06/12; + ESP		24.4122-1703.3 010843	TRW Ø 22,2	
1.6 Flex	83	08/08→12/13		→ 06/12; - ESP		24.4122-1704.3 010847	TRW Ø 22,2	
1.6 16V	88	06/07→10/13		→ 07/13; + ESP		24.4123-1704.3 010828	TRW Ø 23,8	
1.6 HDi	82	08/09→10/13		→ 07/13; - ESP		24.4123-1705.3 010832	TRW Ø 23,8	
1.6 16V RC	128	02/07→12/12		11/07→; + ESP		24.4123-1704.3 010828	TRW Ø 23,8	
				11/07→; - ESP		24.4123-1705.3 010832	TRW Ø 23,8	
1.6 16V Turbo	110	02/07→12/12		+ ESP		24.4123-1704.3 010828	TRW Ø 23,8	
1.6 HDi	66 - 80	06/07→12/13		- ESP		24.4123-1705.3 010832	TRW Ø 23,8	
2.0 HDi	66	10/08→12/12		+ ABS		03.2122-1351.3 010528	Ø 22,2	
PEUGEOT - 207 SW Kasten/Kombi (WK_) 08/07→12/12								
 Hauptbremszylinder								
1.6 HDi	66	08/07→12/12		+ ESP		24.4122-1703.3 010843	TRW Ø 22,2	
				- ESP		24.4122-1704.3 010847	TRW Ø 22,2	
1.6 HDi	80	08/07→12/12		+ ESP		24.4123-1704.3 010828	TRW Ø 23,8	
				- ESP		24.4123-1705.3 010832	TRW Ø 23,8	
PEUGEOT - 208 I (CA_, CC_) 03/12→03/20								
 Hauptbremszylinder								
1.0	50	03/12→12/19		Orga 13342→; Trommelbremse; + DSC		24.4122-1703.3 010843	TRW Ø 22,2	
→								













	kw					! #		
PEUGEOT - 208 I (CA_, CC_) 03/12→03/20								
 Hauptbremszylinder								
1.2 GPL	60	06/15→12/19		Orga 13342→; Trommelbremse; - DSC		24.4122-1704.3	010847	TRW Ø 22,2
1.2 THP 110	81	01/13→12/19		Scheibenbremse; + DSC		24.4123-1704.3	010828	TRW Ø 23,8
1.2 VTI 82	60	03/12→12/19		Scheibenbremse; - DSC		24.4123-1705.3	010832	TRW Ø 23,8
1.2 PureTech 82	61	03/18→12/19		Scheibenbremse; + DSC		24.4123-1704.3	010828	TRW Ø 23,8
1.2 VTI 68 / PureTech 68	50	08/16→12/19		Scheibenbremse; - DSC		24.4123-1705.3	010832	TRW Ø 23,8
1.5 BlueHDi 100	75	05/18→12/19						
1.6 BlueHDi 100	73	01/15→12/19						
1.6 THP 165	121	03/15→12/19						
1.4 GPL	70	10/13→12/19		Trommelbremse; + DSC		24.4122-1703.3	010843	TRW Ø 22,2
1.4 HDi	50	03/12→12/19		Trommelbremse; - DSC		24.4122-1704.3	010847	TRW Ø 22,2
1.4 VTI	70	03/12→12/19		Scheibenbremse; + DSC		24.4123-1704.3	010828	TRW Ø 23,8
1.6	85 -	03/12→12/19		Scheibenbremse; - DSC		24.4123-1705.3	010832	TRW Ø 23,8
	115							
1.6 BlueHDi 120	88	01/15→12/19						
1.6 e-HDi	82	07/15→12/19						
1.6 HDi	68 -	03/12→12/19						
	85							
1.6 HDi / BlueHDi 75	55	01/13→12/19						
1.6 GTi	147	08/12→12/19		03/13→; + DSC		24.4123-1704.3	010828	TRW Ø 23,8
				03/13→; - DSC		24.4123-1705.3	010832	TRW Ø 23,8
1.6 GTi	153	10/14→12/19		+ DSC		24.4123-1704.3	010828	TRW Ø 23,8
				- DSC		24.4123-1705.3	010832	TRW Ø 23,8
PEUGEOT - 208 Kasten/Schrägheck (CR_) 02/13→12/19								
 Hauptbremszylinder								
1.2 VTI 68 / PureTech 68	50	06/15→12/19		Scheibenbremse; + DSC		24.4123-1704.3	010828	TRW Ø 23,8
1.5 BlueHDi 100	75	05/18→12/19		Scheibenbremse; - DSC		24.4123-1705.3	010832	TRW Ø 23,8
1.6 Blue HDi 100	73	06/15→12/19						
1.2 VTI 82 / PureTech 82	60	06/15→12/19		Orga 13342→; Trommelbremse; + DSC		24.4122-1703.3	010843	TRW Ø 22,2
				Orga 13342→; Trommelbremse; - DSC		24.4122-1704.3	010847	TRW Ø 22,2
				Scheibenbremse; + DSC		24.4123-1704.3	010828	TRW Ø 23,8
				Scheibenbremse; - DSC		24.4123-1705.3	010832	TRW Ø 23,8
1.4 HDi 68	50	02/13→12/19		Trommelbremse; + DSC		24.4122-1703.3	010843	TRW Ø 22,2
1.6 BlueHDi 75	55	04/15→12/19		Trommelbremse; - DSC		24.4122-1704.3	010847	TRW Ø 22,2
1.6 HDi 92	68	03/14→12/19		Scheibenbremse; + DSC		24.4123-1704.3	010828	TRW Ø 23,8
				Scheibenbremse; - DSC		24.4123-1705.3	010832	TRW Ø 23,8
PEUGEOT - 301 11/12→								
 Hauptbremszylinder								
1.2 PureTech 82	61	02/18→		+ DSC		24.4122-1703.3	010843	TRW Ø 22,2
				- DSC		24.4122-1704.3	010847	TRW Ø 22,2
1.5 BlueHDi 100	75	05/18→		+ ESP		24.4122-1703.3	010843	TRW Ø 22,2
1.6 BlueHDi 100	73	04/14→						
1.6 HDi 90	68	11/12→						
PEUGEOT - 306 (7B, N3, N5) 04/93→10/03								
 Bremskraftverstärker								
1.1	44	06/94→05/01		→ 04/97; + ABS; für Linkslenker		03.7750-9402.4	300117	ATE Ø 9" pneumatisch
1.4 SL	55	06/94→05/01		05/97→; - ABS		03.7750-9302.4	300116	ATE Ø 9" pneumatisch
				10/94→; →Orga 08575; + ABS; für Linkslenker		03.7750-9402.4	300117	ATE Ø 9" pneumatisch
1.6	72	10/00→05/01		- ABS		03.7750-9302.4	300116	ATE Ø 9" pneumatisch
1.6 SR	65	06/94→10/00		10/94→ 04/97; für Rechtslenker; + ABS		03.7750-6334.4	300321	ATE Ø 9" pneumatisch
				05/97→; - ABS; Türenanzahl: 4		03.7750-9302.4	300116	ATE Ø 9" pneumatisch
				10/94→; →Orga 08575; + ABS; für Linkslenker		03.7750-9402.4	300117	ATE Ø 9" pneumatisch
1.8	74	06/94→05/01		05/97→; - ABS; für Linkslenker		03.7750-9302.4	300116	ATE Ø 9" pneumatisch
2.0 S16	110	06/94→05/01		→Orga 08575; + ABS; für Linkslenker		03.7750-9402.4	300117	ATE Ø 9" pneumatisch
1.8 16V	81	03/97→05/01		05/97→; - ABS; für Linkslenker; Türenanzahl: 4		03.7750-9302.4	300116	ATE Ø 9" pneumatisch
1.8 ST	74	06/94→05/01						
2.0 ST	89	07/94→05/01		→Orga 08575; + ABS; für Linkslenker		03.7750-9402.4	300117	ATE Ø 9" pneumatisch
1.8 16V	82	03/97→07/01		05/97→ 05/01; - ABS; für Linkslenker; Türenanzahl: 4		03.7750-9302.4	300116	ATE Ø 9" pneumatisch
				→Orga 08575; + ABS; für Linkslenker		03.7750-9402.4	300117	ATE Ø 9" pneumatisch
1.9 D	51	09/98→05/01		- ABS; für Linkslenker		03.7750-9302.4	300116	ATE Ø 9" pneumatisch
2.0 HDI 90	66	06/99→12/01		→Orga 08575; + ABS; für Linkslenker		03.7750-9402.4	300117	ATE Ø 9" pneumatisch
1.9 D	55	03/98→05/01		- ABS; für Linkslenker		03.7750-9302.4	300116	ATE Ø 9" pneumatisch
→								











	kw			 	! #		
PEUGEOT - 306 (7B, N3, N5) 04/93→10/03							
 Bremskraftverstärker							
1.9 D	55	03/98→05/01		+ ABS; für Linkslenker		03.7750-9402.4 300117	ATE Ø 9" pneumatisch
1.9 SLD	47	06/94→05/01		05/97→; - ABS; für Linkslenker		03.7750-9302.4 300116	ATE Ø 9" pneumatisch
1.9 SRDT	50	06/94→05/01		10/94→; + ABS; für Linkslenker		03.7750-9402.4 300117	ATE Ø 9" pneumatisch
2.0	97	03/97→05/01		05/97→; - ABS; für Linkslenker; Türenanzahl: 4		03.7750-9302.4 300116	ATE Ø 9" pneumatisch
				05/97→; - ABS; für Linkslenker		03.7750-9302.4 300116	ATE Ø 9" pneumatisch
				→Orga 08575; + ABS; für Linkslenker		03.7750-9402.4 300117	ATE Ø 9" pneumatisch
2.0 S16	112	06/94→05/01		05/97→; - ABS; für Linkslenker		03.7750-9302.4 300116	ATE Ø 9" pneumatisch
				07/94→; →Orga 08575; + ABS; für Linkslenker		03.7750-9402.4 300117	ATE Ø 9" pneumatisch
 Hauptbremszylinder							
1.1	44	06/94→05/01		→ 04/97; - ABS; Türenanzahl: 5		03.2119-3391.3 010058	ATE Ø 19
				→ 04/97; - ABS; Türenanzahl: 3		24.2119-1702.3 010435	BDX Ø 19
				→ 04/97; S 30209025→; + ABS		24.2122-1705.3 010434	Ø 22,2
1.4 SL	55	06/94→05/01		10/94→ 04/97; - ABS; nicht für Fahrschulwagen		03.2119-3391.3 010058	ATE Ø 19
				05/97→; - ABS		03.2120-4321.3 010525	ATE Ø 20,6
				05/97→; →Orga 08575; + ABS; für Linkslenker		24.2120-1726.3 010564	BDX Ø 20,6
				10/94→ 04/97; - ABS; für Fahrschulwagen		03.2122-1351.3 010528	Ø 22,2
				→ 04/97; S 30209025→; + ABS		24.2120-1704.3 010429	BDX Ø 20,6
				Orga 08576→; + ABS; für Linkslenker		24.2122-1705.3 010434	Ø 22,2
1.6	72	10/00→05/01		- ABS		03.2120-4321.3 010525	ATE Ø 20,6
				+ ABS; für Linkslenker		24.2120-1726.3 010564	BDX Ø 20,6
						24.2123-1715.3 010520	BDX Ø 23,8
1.6 SR	65	06/94→10/00		10/94→ 04/97; - ABS; für Linkslenker		03.2120-1897.3 010103	ATE Ø 20,6
				05/97→; - ABS; Türenanzahl: 4		24.2120-1704.3 010429	BDX Ø 20,6
				05/97→; →Orga 08575; + ABS; für Linkslenker		03.2120-4321.3 010525	ATE Ø 20,6
				→ 04/97; S 30209025→; + ABS		24.2120-1726.3 010564	BDX Ø 20,6
				Orga 08576→; + ABS; für Linkslenker		03.2122-1351.3 010528	Ø 22,2
1.8	74	06/94→05/01		- ABS; für Linkslenker		24.2123-1715.3 010520	BDX Ø 23,8
				05/97→; - ABS; für Linkslenker		03.2120-1897.3 010103	ATE Ø 20,6
				05/97→; - ABS; für Linkslenker		24.2120-1704.3 010429	BDX Ø 20,6
				05/97→; →Orga 08575; + ABS; für Linkslenker		03.2120-4321.3 010525	ATE Ø 20,6
				- ABS; für Rechtslenker		24.2120-1726.3 010564	BDX Ø 20,6
				S 30209025→; + ABS		24.2122-1733.3 010668	Ø 22,2
1.8 16V	81	03/97→05/01		Orga 08576→; + ABS; für Linkslenker		24.2122-1705.3 010434	Ø 22,2
				→ 04/97; - ABS; für Linkslenker; Türenanzahl: 4		24.2123-1715.3 010520	BDX Ø 23,8
				05/97→; →Orga 08575; + ABS; für Linkslenker		03.2120-1897.3 010103	ATE Ø 20,6
				05/97→; - ABS; für Linkslenker; Türenanzahl: 4		24.2120-1704.3 010429	BDX Ø 20,6
				→ 04/97; + ABS		03.2122-1351.3 010528	Ø 22,2
1.8 16V	82	03/97→07/01		05/97→; →Orga 08575; + ABS; für Linkslenker		24.2122-1705.3 010434	Ø 22,2
				→ 04/97; - ABS; für Linkslenker; Türenanzahl: 4		24.2123-1715.3 010520	BDX Ø 23,8
				05/97→; →Orga 08575; + ABS; für Linkslenker		03.2120-1897.3 010103	ATE Ø 20,6
				05/97→ 05/01; - ABS; für Linkslenker; Türenanzahl: 4		24.2120-1704.3 010429	BDX Ø 20,6
				→ 04/97; + ABS		03.2122-1351.3 010528	Ø 22,2
1.8 ST →	74	06/94→05/01		Orga 08576→; → 05/01; + ABS; für Linkslenker		24.2123-1715.3 010520	BDX Ø 23,8
				10/94→ 04/97; - ABS; für Linkslenker		03.2120-1897.3 010103	ATE Ø 20,6









	kw			 	! #		
PEUGEOT - 306 (7B, N3, N5) 04/93→10/03							
 Hauptbremszylinder							
1.8 ST	74	06/94→05/01	10/94→ 04/97; - ABS; für Linkslenker	24.2120-1704.3	010429	BDX Ø 20,6	
			05/97→; - ABS; für Linkslenker; Türenanzahl: 4	03.2120-4321.3	010525	ATE Ø 20,6	
			24.2120-1726.3	010564	BDX Ø 20,6		
			05/97→; →Orga 08575; + ABS; für Linkslenker	03.2122-1351.3	010528	Ø 22,2	
			10/94→; - ABS; für Rechtslenker; Türenanzahl: 4	24.2120-1722.3	010544	Ø 20,6	
			→ 04/97; S 30209025→; + ABS	24.2122-1705.3	010434	Ø 22,2	
1.9 D	51	09/98→05/01	Orga 08576→; + ABS; für Linkslenker	24.2123-1715.3	010520	BDX Ø 23,8	
			- ABS; für Linkslenker	03.2120-4321.3	010525	ATE Ø 20,6	
			24.2120-1726.3	010564	BDX Ø 20,6		
			→Orga 08575; + ABS; für Linkslenker	03.2122-1351.3	010528	Ø 22,2	
			- ABS; für Rechtslenker	03.2122-1461.3	010610	ATE Ø 22,2	
			→Orga 08575; + ABS; für Rechtslenker	03.2122-1461.3	010610	ATE Ø 22,2	
1.9 D	55	03/98→05/01	Orga 08576→; + ABS; für Linkslenker	24.2123-1715.3	010520	BDX Ø 23,8	
			- ABS; für Linkslenker	03.2120-4321.3	010525	ATE Ø 20,6	
			24.2120-1726.3	010564	BDX Ø 20,6		
			→Orga 08575; + ABS; für Linkslenker	03.2122-1351.3	010528	Ø 22,2	
1.9 SLD	47 - 50	06/94→05/01	- ABS; für Rechtslenker	24.2120-1722.3	010544	Ø 20,6	
			→Orga 08575; + ABS; für Linkslenker	24.2123-1715.3	010520	BDX Ø 23,8	
			10/94→ 04/97; - ABS; für Linkslenker	03.2120-1897.3	010103	ATE Ø 20,6	
			24.2120-1704.3	010429	BDX Ø 20,6		
			05/97→; - ABS; für Linkslenker	03.2120-4321.3	010525	ATE Ø 20,6	
			24.2120-1726.3	010564	BDX Ø 20,6		
1.9 SRDT	66	06/94→05/01	05/97→; →Orga 08575; + ABS; für Linkslenker	03.2122-1351.3	010528	Ø 22,2	
			10/94→ 04/97; - ABS; für Linkslenker	03.2120-1897.3	010103	ATE Ø 20,6	
			24.2120-1704.3	010429	BDX Ø 20,6		
			05/97→; - ABS; für Linkslenker	03.2122-1356.3	010529	Ø 22,2	
			10/94→ 04/97; + ABS	24.2122-1705.3	010434	Ø 22,2	
			Orga 08576→; + ABS; für Linkslenker	24.2123-1715.3	010520	BDX Ø 23,8	
2.0	97	03/97→05/01	→ 04/97	24.2122-1705.3	010434	Ø 22,2	
			→ 04/97; - ABS; für Linkslenker	03.2120-1897.3	010103	ATE Ø 20,6	
			24.2120-1704.3	010429	BDX Ø 20,6		
			→ 04/97; - ABS; für Linkslenker; Türenanzahl: 4	03.2120-1897.3	010103	ATE Ø 20,6	
			24.2120-1704.3	010429	BDX Ø 20,6		
			05/97→; →Orga 08575; + ABS; für Linkslenker	03.2122-1351.3	010528	Ø 22,2	
			24.2122-1733.3	010668	Ø 22,2		
			05/97→; - ABS; für Linkslenker; Türenanzahl: 4	03.2122-1356.3	010529	Ø 22,2	
			05/97→; - ABS; für Linkslenker	03.2122-1356.3	010529	Ø 22,2	
2.0 HDI 90	66	06/99→12/01	→ 04/97; + ABS	24.2122-1705.3	010434	Ø 22,2	
			→ 04/97	24.2122-1705.3	010434	Ø 22,2	
2.0 S16	110	06/94→05/01	Orga 08576→; + ABS; für Linkslenker	24.2123-1715.3	010520	BDX Ø 23,8	
			- ABS; für Linkslenker	03.2122-1356.3	010529	Ø 22,2	
			+ ABS; für Linkslenker	24.2123-1715.3	010520	BDX Ø 23,8	
			→ 04/97; - ABS; für Linkslenker	03.2120-1897.3	010103	ATE Ø 20,6	
			24.2120-1704.3	010429	BDX Ø 20,6		
			05/97→; →Orga 08575; + ABS; für Linkslenker	03.2122-1351.3	010528	Ø 22,2	
2.0 S16	112	06/94→05/01	05/97→; - ABS; für Linkslenker	03.2122-1356.3	010529	Ø 22,2	
			→ 04/97; + ABS	24.2122-1705.3	010434	Ø 22,2	
			Orga 08576→; + ABS; für Linkslenker	24.2123-1715.3	010520	BDX Ø 23,8	
			07/94→ 04/97; - ABS; für Linkslenker	03.2120-1897.3	010103	ATE Ø 20,6	
			24.2120-1704.3	010429	BDX Ø 20,6		
			05/97→; →Orga 08575; + ABS; für Linkslenker	03.2122-1351.3	010528	Ø 22,2	
→							



























	kw					! #		
PEUGEOT - 306 (7B, N3, N5) 04/93→10/03								
 Hauptbremszylinder								
2.0 S16	112	06/94→05/01			Orga 08576→; + ABS; für Linkslenker		24.2123-1715.3 010520	BDX Ø 23,8
2.0 ST	89	07/94→05/01			10/94→ 04/97; - ABS; für Linkslenker; Türenanzahl: 4		03.2120-1897.3 010103	ATE Ø 20,6
							24.2120-1704.3 010429	BDX Ø 20,6
					05/97→; →Orga 08575; + ABS; für Linkslenker		03.2122-1351.3 010528	Ø 22,2
					05/97→; - ABS; für Linkslenker; Türenanzahl: 4		03.2122-1356.3 010529	Ø 22,2
					→ 04/97; + ABS		24.2122-1705.3 010434	Ø 22,2
					Orga 08576→; + ABS; für Linkslenker		24.2123-1715.3 010520	BDX Ø 23,8
PEUGEOT - 306 Break (7E, N3, N5) 06/94→12/02								
 Bremskraftverstärker								
1.4	55	03/97→04/02			→ 03/02; - ABS		03.7750-9302.4 300116	ATE Ø 9" pneumatisch
1.6	72	10/00→04/02						
1.6	65	03/97→10/00			- ABS		03.7750-9302.4 300116	ATE Ø 9" pneumatisch
1.8 D	44	05/97→06/00			- ABS; für Linkslenker		03.7750-9302.4 300116	ATE Ø 9" pneumatisch
1.9 D	51	05/97→05/99						
1.9 D	50 - 55	03/97→04/02			→ 03/02; - ABS; für Linkslenker		03.7750-9302.4 300116	ATE Ø 9" pneumatisch
 Hauptbremszylinder								
1.4	55	03/97→04/02			→ 03/02; - ABS		03.2122-1356.3 010529	Ø 22,2
1.6	72	10/00→04/02			→ 03/02; + ABS; für Linkslenker		24.2123-1715.3 010520	BDX Ø 23,8
1.6	65	03/97→10/00			- ABS		03.2122-1356.3 010529	Ø 22,2
					+ ABS; für Linkslenker		24.2123-1715.3 010520	BDX Ø 23,8
1.8	74	03/97→04/02			→ 03/02; für Linkslenker; - ABS		24.2123-1714.3 010587	BDX Ø 23,8
1.8 16V	81	03/97→04/02						
2.0	97	03/97→04/02			→ 03/02; + ABS; für Linkslenker		24.2123-1715.3 010520	BDX Ø 23,8
2.0 16V	99	03/97→04/02						
2.0 HDI 90	66	06/99→04/02						
1.8 16V	82	03/97→07/01			für Linkslenker; - ABS		24.2123-1714.3 010587	BDX Ø 23,8
					+ ABS; für Linkslenker		24.2123-1715.3 010520	BDX Ø 23,8
1.8 D	44	05/97→06/00			- ABS; für Linkslenker		03.2122-1356.3 010529	Ø 22,2
1.9 D	51	05/97→05/99			+ ABS; für Linkslenker		24.2123-1715.3 010520	BDX Ø 23,8
1.9 D	50 - 55	03/97→04/02			→ 03/02; - ABS; für Linkslenker		03.2122-1356.3 010529	Ø 22,2
					→ 03/02; + ABS; für Linkslenker		24.2123-1715.3 010520	BDX Ø 23,8
1.9 Td	52	07/95→08/00			03/97→; - ABS; für Linkslenker		03.2122-1356.3 010529	Ø 22,2
							24.2123-1714.3 010587	BDX Ø 23,8
					03/97→; + ABS; für Linkslenker		24.2123-1715.3 010520	BDX Ø 23,8
1.9 TD	66	02/97→04/02			03/97→ 03/02; - ABS; für Linkslenker		03.2122-1356.3 010529	Ø 22,2
							24.2123-1714.3 010587	BDX Ø 23,8
					03/97→ 03/02; + ABS; für Linkslenker		24.2123-1715.3 010520	BDX Ø 23,8
PEUGEOT - 306 Cabriolet (7D, N3, N5) 01/94→04/02								
 Bremskraftverstärker								
1.6	65	04/96→10/00			für Rechtslenker		03.7750-6334.4 300321	ATE Ø 9" pneumatisch
					→Orga 08575; für Linkslenker		03.7750-9402.4 300117	ATE Ø 9" pneumatisch
1.8	74	03/94→04/02			→Orga 08575; für Linkslenker		03.7750-9402.4 300117	ATE Ø 9" pneumatisch
2.0	89	03/94→04/02						
2.0 16V	97 - 99	03/97→04/02						
 Hauptbremszylinder								
1.6	65	04/96→10/00			→Orga 07737; - ABS		03.2120-4241.3 010524	ATE Ø 20,6
							24.2120-1722.3 010544	Ø 20,6
					→Orga 08575; + ABS; für Linkslenker		03.2122-1351.3 010528	Ø 22,2
					Orga 08576→; + ABS; für Linkslenker		24.2123-1715.3 010520	BDX Ø 23,8
1.6	72	10/00→04/02			+ ABS; für Linkslenker		24.2123-1715.3 010520	BDX Ø 23,8
1.8 16V	81	05/97→04/02						
1.8	74	03/94→04/02			→Orga 08575; + ABS; für Linkslenker		03.2122-1351.3 010528	Ø 22,2
							24.2120-1722.3 010544	Ø 20,6
					→ 10/00; - ABS		24.2120-1722.3 010544	Ø 20,6
					Orga 08576→; → 10/00; + ABS; für Linkslenker		24.2123-1715.3 010520	BDX Ø 23,8
1.8	74	05/97→04/99			→Orga 08575; + ABS; für Linkslenker		03.2122-1351.3 010528	Ø 22,2
							24.2120-1722.3 010544	Ø 20,6
					- ABS		24.2120-1722.3 010544	Ø 20,6
					Orga 08576→; + ABS; für Linkslenker		24.2123-1715.3 010520	BDX Ø 23,8
→								













	kw					! #		
PEUGEOT - 306 Cabriolet (7D, N3, N5) 01/94→04/02								
 Hauptbremszylinder								
2.0	89	03/94→04/02		→ 04/97; + ABS; für Linkslenker		03.2122-1351.3 010528	Ø 22,2	
				→Orga 07744; - ABS		24.2122-1705.3 010434	Ø 22,2	
2.0 16V	97	03/97→04/02		→Orga 08575; + ABS; für Linkslenker		03.2122-1351.3 010528	Ø 22,2	
				→Orga 07744; - ABS		24.2122-1705.3 010434	Ø 22,2	
				Orga 08576→; → 10/00; + ABS; für Linkslenker		24.2123-1715.3 010520	BDX Ø 23,8	
2.0 16V	99	03/97→04/02		→Orga 08575; + ABS; für Linkslenker		03.2122-1351.3 010528	Ø 22,2	
				→Orga 07744; - ABS		24.2122-1705.3 010434	Ø 22,2	
				Orga 08576→; + ABS; für Linkslenker		24.2123-1715.3 010520	BDX Ø 23,8	
PEUGEOT - 306 Kasten/Kombi (N_, 7_) 07/93→08/02								
 Bremskraftverstärker								
1.4	55	03/96→07/01		05/97→ 05/01; - ABS		03.7750-9302.4 300116	ATE Ø 9" pneumatisch	
				→Orga 08575; + ABS; für Linkslenker		03.7750-9402.4 300117	ATE Ø 9" pneumatisch	
1.8 D	44	05/97→06/00		- ABS; für Linkslenker		03.7750-9302.4 300116	ATE Ø 9" pneumatisch	
1.9 D	50	05/97→05/99						
1.9 D	51	02/99→08/02		→ 03/02; - ABS; für Linkslenker		03.7750-9302.4 300116	ATE Ø 9" pneumatisch	
1.9 D	68	02/94→04/99		05/97→; - ABS; für Linkslenker		03.7750-9302.4 300116	ATE Ø 9" pneumatisch	
				→Orga 08575; + ABS; für Linkslenker		03.7750-9402.4 300117	ATE Ø 9" pneumatisch	
1.9 STD	51	02/94→05/99		09/98→; →Orga 08575; + ABS; für Linkslenker		03.7750-9402.4 300117	ATE Ø 9" pneumatisch	
 Hauptbremszylinder								
1.4	55	03/96→07/01		→ 04/97; - ABS; nicht für Fahrschulwagen; Türenanzahl: 5		03.2119-3391.3 010058	ATE Ø 19	
						24.2119-1702.3 010435	BDX Ø 19	
				05/97→ 05/01; - ABS		03.2120-4321.3 010525	ATE Ø 20,6	
						24.2120-1726.3 010564	BDX Ø 20,6	
				05/97→; →Orga 08575; + ABS; für Linkslenker		03.2122-1351.3 010528	Ø 22,2	
						24.2122-1733.3 010668	Ø 22,2	
				→ 04/97; - ABS; für Fahrschulwagen; Türenanzahl: 3		24.2120-1704.3 010429	BDX Ø 20,6	
				→ 04/97; S 30209025→; + ABS		24.2122-1705.3 010434	Ø 22,2	
				Orga 08576→; → 05/01; + ABS; für Linkslenker		24.2123-1715.3 010520	BDX Ø 23,8	
1.8 D	44	05/97→06/00		- ABS; für Linkslenker		03.2122-1356.3 010529	Ø 22,2	
1.9 D	50	05/97→05/99		+ ABS; für Linkslenker		24.2123-1715.3 010520	BDX Ø 23,8	
1.9 D	51	02/99→08/02		→ 03/02; - ABS; für Linkslenker		03.2122-1356.3 010529	Ø 22,2	
				→ 03/02; + ABS; für Linkslenker		24.2123-1715.3 010520	BDX Ø 23,8	
1.9 D	68	02/94→04/99		→ 04/97; - ABS; für Linkslenker		03.2120-1897.3 010103	ATE Ø 20,6	
						24.2120-1704.3 010429	BDX Ø 20,6	
				05/97→; →Orga 08575; + ABS; für Linkslenker		03.2122-1351.3 010528	Ø 22,2	
						24.2122-1733.3 010668	Ø 22,2	
				05/97→; - ABS; für Linkslenker		03.2122-1356.3 010529	Ø 22,2	
				→ 04/97; + ABS		24.2122-1705.3 010434	Ø 22,2	
				Orga 08576→; + ABS; für Linkslenker		24.2123-1715.3 010520	BDX Ø 23,8	
1.9 STD	51	02/94→05/99		09/98→; - ABS; für Rechtslenker		03.2122-1461.3 010610	ATE Ø 22,2	
				05/97→; →Orga 08575; + ABS; für Rechtslenker		03.2122-1461.3 010610	ATE Ø 22,2	
2.0 HDi	66	08/98→06/00		- ABS; für Linkslenker		24.2123-1714.3 010587	BDX Ø 23,8	
				+ ABS; für Linkslenker		24.2123-1715.3 010520	BDX Ø 23,8	
PEUGEOT - 306 Kasten/Schrägheck 04/93→08/01								
 Bremskraftverstärker								
1.4	55	03/96→07/01		05/97→ 05/01; - ABS		03.7750-9302.4 300116	ATE Ø 9" pneumatisch	
				→Orga 08575; + ABS; für Linkslenker		03.7750-9402.4 300117	ATE Ø 9" pneumatisch	
1.8 D	44	04/93→05/99		05/97→; - ABS; für Linkslenker		03.7750-9302.4 300116	ATE Ø 9" pneumatisch	
				+ ABS; für Linkslenker		03.7750-9402.4 300117	ATE Ø 9" pneumatisch	
1.9 D	50	05/97→05/99		+ ABS; für Linkslenker		03.7750-9402.4 300117	ATE Ø 9" pneumatisch	
1.9 D	51	02/99→08/01		→Orga 08575; + ABS; für Linkslenker		03.7750-9402.4 300117	ATE Ø 9" pneumatisch	
 Hauptbremszylinder								
1.4	55	03/96→07/01		→ 04/97; - ABS; nicht für Fahrschulwagen; Türenanzahl: 5		03.2119-3391.3 010058	ATE Ø 19	
						24.2119-1702.3 010435	BDX Ø 19	
→								

	kw					! #		
PEUGEOT - 306 Kasten/Schrägheck 04/93→08/01								
 Hauptbremszylinder								
1.4	55	03/96→07/01		05/97→ 05/01; - ABS	03.2120-4321.3 010525	ATE Ø 20,6		
				05/97→; →Orga 08575; + ABS; für Linkslenker	24.2120-1726.3 010564	BDX Ø 20,6		
				→ 04/97; - ABS; für Fahrschulwagen; Türenanzahl: 3	03.2122-1351.3 010528	Ø 22,2		
				→ 04/97; S 30209025→; + ABS	24.2122-1733.3 010668	Ø 22,2		
				→ 04/97; - ABS; für Linkslenker	24.2120-1704.3 010429	BDX Ø 20,6		
1.8 D	44	04/93→05/99		→ 04/97; - ABS; für Linkslenker	24.2122-1705.3 010434	Ø 22,2		
				Orga 08576→; → 05/01; + ABS; für Linkslenker	24.2123-1715.3 010520	BDX Ø 23,8		
				→ 04/97; - ABS; für Linkslenker	03.2120-1897.3 010103	ATE Ø 20,6		
				05/97→; - ABS; für Linkslenker	24.2120-1704.3 010429	BDX Ø 20,6		
				05/97→; →Orga 08575; + ABS; für Linkslenker	03.2120-4321.3 010525	ATE Ø 20,6		
1.9 D	50	05/97→05/99		- ABS; für Rechtslenker	24.2120-1726.3 010564	BDX Ø 20,6		
				→ 04/97; S 30209025→; + ABS	03.2122-1351.3 010528	Ø 22,2		
				Orga 08576→; + ABS; für Linkslenker	24.2122-1733.3 010668	Ø 22,2		
				- ABS; für Rechtslenker	24.2120-1722.3 010544	Ø 20,6		
				→ 04/97; - ABS; für Rechtslenker	24.2122-1705.3 010434	Ø 22,2		
1.9 D	51	02/99→08/01		→ 05/01; - ABS; für Rechtslenker	24.2123-1715.3 010520	BDX Ø 23,8		
				→Orga 08575; + ABS; für Rechtslenker	03.2122-1461.3 010610	ATE Ø 22,2		
				→Orga 08575; + ABS; für Rechtslenker	03.2122-1461.3 010610	ATE Ø 22,2		
PEUGEOT - 306 Schrägheck (7A, 7C, N3, N5) 01/93→10/03								
 Bremskraftverstärker								
1.1	44	05/93→05/01		03/94→ 04/97; + ABS; für Linkslenker	03.7750-9402.4 300117	ATE Ø 9" pneumatisch		
1.4	55	04/93→07/01		05/97→; - ABS	03.7750-9302.4 300116	ATE Ø 9" pneumatisch		
				→Orga 08575; + ABS; für Linkslenker	03.7750-9402.4 300117	ATE Ø 9" pneumatisch		
1.6	65	05/93→10/00		→ 04/97; + ABS; für Rechtslenker	03.7750-6334.4 300321	ATE Ø 9" pneumatisch		
				05/97→; - ABS	03.7750-9302.4 300116	ATE Ø 9" pneumatisch		
				→Orga 08575; + ABS; für Linkslenker	03.7750-9402.4 300117	ATE Ø 9" pneumatisch		
1.6	72	10/00→05/01		- ABS	03.7750-9302.4 300116	ATE Ø 9" pneumatisch		
1.8 1.8 16V 1.9 Td 2.0 16V 2.0 S16	74	05/93→05/01		05/97→; - ABS; für Linkslenker	03.7750-9302.4 300116	ATE Ø 9" pneumatisch		
	81	03/97→05/01		→Orga 08575; + ABS; für Linkslenker	03.7750-9402.4 300117	ATE Ø 9" pneumatisch		
	52	07/95→08/00						
	99	03/97→06/00						
	110	06/94→05/01						
1.8 16V	82	03/97→10/03		05/97→ 05/01; - ABS; für Linkslenker	03.7750-9302.4 300116	ATE Ø 9" pneumatisch		
				→Orga 08575; + ABS; für Linkslenker	03.7750-9402.4 300117	ATE Ø 9" pneumatisch		
1.8 D	43 - 44	04/93→05/01		05/97→; - ABS; für Linkslenker	03.7750-9302.4 300116	ATE Ø 9" pneumatisch		
1.9 D	47 - 50	05/93→05/01		+ ABS; für Linkslenker	03.7750-9402.4 300117	ATE Ø 9" pneumatisch		
1.9 D	51	04/93→05/99		09/98→; →Orga 08575; + ABS; für Linkslenker	03.7750-9402.4 300117	ATE Ø 9" pneumatisch		
1.9 D 2.0 HDI 90	51	09/98→05/01		- ABS; für Linkslenker	03.7750-9302.4 300116	ATE Ø 9" pneumatisch		
	66	06/99→12/02		→Orga 08575; + ABS; für Linkslenker	03.7750-9402.4 300117	ATE Ø 9" pneumatisch		
1.9 D	52	01/99→08/03		→Orga 08575; + ABS; für Linkslenker	03.7750-9402.4 300117	ATE Ø 9" pneumatisch		
1.9 D	55	03/98→05/01		- ABS; für Linkslenker	03.7750-9302.4 300116	ATE Ø 9" pneumatisch		
				+ ABS; für Linkslenker	03.7750-9402.4 300117	ATE Ø 9" pneumatisch		
1.9 DT	66	05/93→05/01		05/97→; - ABS; für Linkslenker	03.7750-9302.4 300116	ATE Ø 9" pneumatisch		
				10/93→; →Orga 08575; + ABS; für Linkslenker	03.7750-9402.4 300117	ATE Ø 9" pneumatisch		
2.0 16V	97	03/97→05/01		05/97→; - ABS; für Linkslenker; Türenanzahl: 4	03.7750-9302.4 300116	ATE Ø 9" pneumatisch		
				→Orga 08575; + ABS; für Linkslenker	03.7750-9402.4 300117	ATE Ø 9" pneumatisch		
2.0 S16	112	05/93→05/01		05/97→; - ABS; für Linkslenker	03.7750-9302.4 300116	ATE Ø 9" pneumatisch		
				07/94→; →Orga 08575; + ABS; für Linkslenker	03.7750-9402.4 300117	ATE Ø 9" pneumatisch		
2.0 XSi	89	05/93→05/01		05/97→; - ABS; für Linkslenker	03.7750-9302.4 300116	ATE Ø 9" pneumatisch		
				03/94→; →Orga 08575; + ABS; für Linkslenker	03.7750-9402.4 300117	ATE Ø 9" pneumatisch		
 Hauptbremszylinder								
1.1	44	05/93→05/01		03/94→ 04/97; - ABS; Türenanzahl: 5	03.2119-3391.3 010058	ATE Ø 19		
				03/94→ 04/97; - ABS; Türenanzahl: 3	24.2119-1702.3 010435	BDX Ø 19		
→					24.2120-1704.3 010429	BDX Ø 20,6		











	kw			 	! #		
PEUGEOT - 306 Schrägheck (7A, 7C, N3, N5) 01/93→10/03							
 Hauptbremszylinder							
1.1	44	05/93→05/01		→ 04/97; S 30209025→; + ABS		24.2122-1705.3 010434	Ø 22,2
1.4	55	04/93→07/01		→ 04/97; - ABS; nicht für Fahrschulwagen; Türenanzahl: 5		03.2119-3391.3 010058	ATE Ø 19
				→ 04/97; - ABS		24.2119-1702.3 010435	BDX Ø 19
				05/97→; - ABS		03.2120-4321.3 010525	ATE Ø 20,6
				05/97→; - ABS		24.2120-1726.3 010564	BDX Ø 20,6
				05/97→; →Orga 08575; + ABS; für Linkslenker		03.2122-1351.3 010528	Ø 22,2
				05/97→; →Orga 08575; + ABS; für Linkslenker		24.2122-1733.3 010668	Ø 22,2
1.6	65	05/93→10/00		→ 04/97; - ABS		24.2120-1704.3 010429	BDX Ø 20,6
				05/97→; - ABS		03.2120-1897.3 010103	ATE Ø 20,6
				05/97→; - ABS		24.2120-1704.3 010429	BDX Ø 20,6
				05/97→; - ABS		03.2120-4321.3 010525	ATE Ø 20,6
				05/97→; - ABS		24.2120-1726.3 010564	BDX Ø 20,6
				05/97→; →Orga 08575; + ABS; für Linkslenker		03.2122-1351.3 010528	Ø 22,2
1.6	72	10/00→05/01		- ABS		24.2122-1733.3 010668	Ø 22,2
				- ABS		03.2120-4321.3 010525	ATE Ø 20,6
				- ABS		24.2120-1726.3 010564	BDX Ø 20,6
				+ ABS; für Linkslenker		24.2123-1715.3 010520	BDX Ø 23,8
				→ 04/97; S 30209025→; + ABS		24.2122-1705.3 010434	Ø 22,2
				Orga 08576→; + ABS; für Linkslenker		24.2123-1715.3 010520	BDX Ø 23,8
1.8 1.8 D 1.9 D	74 43 - 44 47 - 50	05/93→05/01 04/93→05/01 05/93→05/01		→ 04/97; - ABS; für Linkslenker		03.2120-1897.3 010103	ATE Ø 20,6
				→ 04/97; - ABS; für Linkslenker		24.2120-1704.3 010429	BDX Ø 20,6
				05/97→; - ABS; für Linkslenker		03.2120-4321.3 010525	ATE Ø 20,6
				05/97→; - ABS; für Linkslenker		24.2120-1726.3 010564	BDX Ø 20,6
				05/97→; →Orga 08575; + ABS; für Linkslenker		03.2122-1351.3 010528	Ø 22,2
				05/97→; →Orga 08575; + ABS; für Linkslenker		24.2122-1733.3 010668	Ø 22,2
1.8 16V 1.9 Td 2.0 16V 2.0 S16	81 52 99 110	03/97→05/01 07/95→08/00 03/97→06/00 06/94→05/01		- ABS; für Rechtslenker		24.2120-1722.3 010544	Ø 20,6
				- ABS; für Rechtslenker		03.2120-1722.3 010544	Ø 20,6
				→ 04/97; S 30209025→; + ABS		24.2122-1705.3 010434	Ø 22,2
				Orga 08576→; + ABS; für Linkslenker		24.2123-1715.3 010520	BDX Ø 23,8
				→ 04/97; - ABS; für Linkslenker		03.2120-1897.3 010103	ATE Ø 20,6
				→ 04/97; - ABS; für Linkslenker		24.2120-1704.3 010429	BDX Ø 20,6
1.8 16V	82	03/97→10/03		05/97→; →Orga 08575; + ABS; für Linkslenker		03.2122-1351.3 010528	Ø 22,2
				05/97→; →Orga 08575; + ABS; für Linkslenker		24.2122-1733.3 010668	Ø 22,2
				05/97→ 05/01; - ABS; für Linkslenker		03.2122-1356.3 010529	Ø 22,2
				05/97→ 05/01; - ABS; für Linkslenker		03.2122-1356.3 010529	Ø 22,2
				→ 04/97; + ABS		24.2122-1705.3 010434	Ø 22,2
				Orga 08576→; → 05/01; + ABS; für Linkslenker		24.2123-1715.3 010520	BDX Ø 23,8
1.9 D	51	04/93→05/99		09/98→; - ABS; für Rechtslenker		03.2122-1461.3 010610	ATE Ø 22,2
				05/97→; →Orga 08575; + ABS; für Rechtslenker		03.2122-1461.3 010610	ATE Ø 22,2
1.9 D	51	09/98→05/01		- ABS; für Linkslenker		03.2120-4321.3 010525	ATE Ø 20,6
				- ABS; für Linkslenker		24.2120-1726.3 010564	BDX Ø 20,6
				→Orga 08575; + ABS; für Linkslenker		03.2122-1351.3 010528	Ø 22,2
				→Orga 08575; + ABS; für Linkslenker		24.2122-1733.3 010668	Ø 22,2
				- ABS; für Rechtslenker		03.2122-1461.3 010610	ATE Ø 22,2
				→Orga 08575; + ABS; für Rechtslenker		03.2122-1461.3 010610	ATE Ø 22,2
1.9 D	52	01/99→08/03		Orga 08576→; + ABS; für Linkslenker		24.2123-1715.3 010520	BDX Ø 23,8
				→ 05/01; - ABS; für Rechtslenker		03.2122-1461.3 010610	ATE Ø 22,2
1.9 D	55	03/98→05/01		→Orga 08575; + ABS; für Rechtslenker		03.2122-1461.3 010610	ATE Ø 22,2
				- ABS; für Linkslenker		03.2120-4321.3 010525	ATE Ø 20,6
→				- ABS; für Linkslenker		24.2120-1726.3 010564	BDX Ø 20,6
				→Orga 08575; + ABS; für Linkslenker		03.2122-1351.3 010528	Ø 22,2
				→Orga 08575; + ABS; für Linkslenker		24.2122-1733.3 010668	Ø 22,2











	kw					! #			
PEUGEOT - 306 Schrägheck (7A, 7C, N3, N5) 01/93→10/03									
 Hauptbremszylinder									
1.9 D	55	03/98→05/01		Orga 08576→; + ABS; für Linkslenker		24.2123-1715.3	010520	BDX Ø 23,8	
1.9 DT	66	05/93→05/01		10/93→ 04/97; - ABS; für Linkslenker		03.2120-1897.3	010103	ATE Ø 20,6	
					05/97→; →Orga 08575; + ABS; für Linkslenker		24.2120-1704.3	010429	BDX Ø 20,6
					05/97→; →Orga 08575; + ABS; für Linkslenker		03.2122-1351.3	010528	Ø 22,2
					05/97→; - ABS; für Linkslenker		24.2122-1733.3	010668	Ø 22,2
					10/93→ 04/97; + ABS		03.2122-1356.3	010529	Ø 22,2
				Orga 08576→; + ABS; für Linkslenker		24.2123-1715.3	010520	BDX Ø 23,8	
2.0 16V	97	03/97→05/01		→ 04/97; - ABS; für Linkslenker; Türenanzahl: 4		03.2120-1897.3	010103	ATE Ø 20,6	
					05/97→; →Orga 08575; + ABS; für Linkslenker		24.2120-1704.3	010429	BDX Ø 20,6
					05/97→; - ABS; für Linkslenker; Türenanzahl: 4		03.2122-1351.3	010528	Ø 22,2
					→ 04/97		24.2122-1733.3	010668	Ø 22,2
					05/97→; - ABS; für Linkslenker		03.2122-1356.3	010529	Ø 22,2
				Orga 08576→; + ABS; für Linkslenker		24.2123-1715.3	010520	BDX Ø 23,8	
2.0 HDI 90	66	06/99→12/02		→Orga 08575; + ABS; für Linkslenker		03.2122-1351.3	010528	Ø 22,2	
					- ABS; für Linkslenker		24.2122-1733.3	010668	Ø 22,2
					Orga 08576→; + ABS; für Linkslenker		03.2122-1356.3	010529	Ø 22,2
				Orga 08576→; + ABS; für Linkslenker		24.2123-1715.3	010520	BDX Ø 23,8	
2.0 S16	112	05/93→05/01		07/94→ 04/97; - ABS; für Linkslenker		03.2120-1897.3	010103	ATE Ø 20,6	
					05/97→; →Orga 08575; + ABS; für Linkslenker		24.2120-1704.3	010429	BDX Ø 20,6
					05/97→; →Orga 08575; + ABS; für Linkslenker		03.2122-1351.3	010528	Ø 22,2
					05/97→; - ABS; für Linkslenker		24.2122-1733.3	010668	Ø 22,2
					07/94→ 04/97; + ABS		03.2122-1356.3	010529	Ø 22,2
				Orga 08576→; + ABS; für Linkslenker		24.2122-1705.3	010434	Ø 22,2	
				Orga 08576→; + ABS; für Linkslenker		24.2123-1715.3	010520	BDX Ø 23,8	
2.0 S16	120	06/96→05/01		- ABS		24.2123-1714.3	010587	BDX Ø 23,8	
					+ ABS; für Linkslenker		24.2123-1715.3	010520	BDX Ø 23,8
2.0 XSi	89	05/93→05/01		03/94→ 04/97; - ABS; für Linkslenker		03.2120-1897.3	010103	ATE Ø 20,6	
					05/97→; →Orga 08575; + ABS; für Linkslenker		24.2120-1704.3	010429	BDX Ø 20,6
					05/97→; →Orga 08575; + ABS; für Linkslenker		03.2122-1351.3	010528	Ø 22,2
					05/97→; - ABS; für Linkslenker		24.2122-1733.3	010668	Ø 22,2
					03/94→ 04/97; + ABS		03.2122-1356.3	010529	Ø 22,2
				Orga 08576→; + ABS; für Linkslenker		24.2122-1705.3	010434	Ø 22,2	
				Orga 08576→; + ABS; für Linkslenker		24.2123-1715.3	010520	BDX Ø 23,8	
PEUGEOT - 307 (3A/C) 08/00→12/12									
 Hauptbremszylinder									
1.4 16V	65	11/03→07/07		Orga 11193→; - ESP		24.4123-1730.3	011097	Ø 23,8 ohne Bremsflüssigkeitsbehälter	
1.6	81	07/06→04/12							
1.6 16V	80	08/00→11/07							
1.6 Flex	83	07/06→12/12							
1.6 HDi	66	04/05→03/09							
1.6 HDi 110	80	02/04→03/09							
2.0	105	08/08→12/11							
2.0 16V	103 - 130	03/05→11/07							
2.0 HDi 135	100	10/03→11/07							
PEUGEOT - 307 Break (3E) 03/02→12/09									
 Hauptbremszylinder									
1.4 16V	65	11/03→07/07		Orga 11193→; - ESP		24.4123-1730.3	011097	Ø 23,8 ohne Bremsflüssigkeitsbehälter	
1.6 16V	80	03/02→04/08							
1.6 BioFlex	80	09/07→04/08							
1.6 HDi	66	04/05→04/08							
1.6 HDi 110	80	02/04→04/08							
2.0 16V	103 - 130	03/05→04/08							
2.0 HDi 135	100	02/04→04/08							
PEUGEOT - 307 CC (3B) 03/03→06/09									
 Hauptbremszylinder									
1.6 16V	80	03/03→04/09		Orga 11193→; - ESP		24.4123-1730.3	011097	Ø 23,8 ohne Bremsflüssigkeitsbehälter	
2.0 16V	103 - 130	10/03→04/09							
2.0 HDi 135	100	06/05→04/09							













	kw			 	! #		
PEUGEOT - 307 Stufenheck 01/01→12/12							
 Hauptbremszylinder							
1.6 2.0	81 103	08/06→12/12 09/06→12/08		Orga 11193→; - ESP		24.4123-1730.3 011097	Ø 23,8 ohne Bremsflüssigkeitsbehälter
PEUGEOT - 307 SW (3H) 03/02→12/09							
 Hauptbremszylinder							
1.4 16V 1.6 16V 1.6 BioFlex 1.6 HDi 110 1.6 HDi 90 2.0 16V 2.0 HDi 135	65 80 80 80 66 103 100	11/03→07/07 03/02→04/08 09/07→04/08 11/03→12/07 04/05→04/08 03/05→04/08 02/04→04/08		Orga 11193→; - ESP		24.4123-1730.3 011097	Ø 23,8 ohne Bremsflüssigkeitsbehälter
PEUGEOT - 307 SW Kasten/Kombi (3E_, 3H_) 04/02→12/09							
 Hauptbremszylinder							
1.6 HDi 2.0 HDi	66 100	04/06→10/08 04/04→11/07		Orga 11193→; - ESP		24.4123-1730.3 011097	Ø 23,8 ohne Bremsflüssigkeitsbehälter
PEUGEOT - 308 I (4A_, 4C_) 09/07→12/16							
 Hauptbremszylinder							
1.4 16V 1.6 1.6 16V 1.6 BioFlex 1.6 HDi 1.6 THP 16V 2.0 Bioflex 2.0 HDi	70 - 72 85 - 120 88 - 128 80 66 - 84 115 103 100 - 120	09/07→10/14 01/12→12/15 09/07→10/14 04/08→10/14 09/07→10/14 10/09→10/14 01/08→12/12 09/07→10/14		- ESP		24.4123-1730.3 011097	Ø 23,8 ohne Bremsflüssigkeitsbehälter
PEUGEOT - 308 II (LB_, LP_, LW_, LH_, L3_) 09/13→06/21							
 Hauptbremszylinder							
1.2 THP 110 1.2 THP 130 1.2 VTi 72 1.5 BlueHDi 100 1.5 BlueHDi 130 1.6 BlueHDi 120 1.6 GT 205 1.6 GTi 1.6 GTi PureTech 263 1.6 HDi 1.6 HDi / BlueHDi 115 1.6 HDi 100 1.6 PureTech 225 1.6 THP 1.6 THP 125 1.6 THP 150 1.6 THP 163 1.6 VTi 115 2.0 BlueHDi 150 2.0 GT BlueHDi 180	81 96 60 75 96 88 151 184 - 200 193 68 85 73 165 112 - 115 92 110 120 85 110 130 - 133	11/13→06/21 11/13→06/21 09/13→06/21 05/18→06/21 06/17→06/21 11/13→06/21 06/14→06/21 06/15→06/21 07/18→06/21 09/13→06/21 09/13→06/21 04/14→06/21 01/18→06/21 09/13→06/21 09/13→06/21 03/14→06/21 06/14→06/21 05/15→06/21 11/13→06/21 06/14→06/21				24.4155-1311.3 011053	ATE Ø 25,4 ohne Bremsflüssigkeitsbehälter
PEUGEOT - 308 CC (4B_) 02/09→12/15							
 Hauptbremszylinder							
1.6 16V 1.6 HDi 2.0 CVVT 2.0 HDi	88 - 115 82 - 84 103 100 - 120	06/09→12/14 02/09→12/14 07/09→12/14 04/09→12/14		- ESP		24.4123-1730.3 011097	Ø 23,8 ohne Bremsflüssigkeitsbehälter
PEUGEOT - 308 Kasten/Schrägheck (LB_) 03/15→							
 Hauptbremszylinder							
1.5 BlueHDi 130 1.6 BlueHDi 120 1.6 e-HDi 115	96 88 85	06/17→06/21 03/15→06/21 03/15→06/21				24.4155-1311.3 011053	ATE Ø 25,4 ohne Bremsflüssigkeitsbehälter















	kw					! #		
PEUGEOT - 308 SW I (4E_, 4H_) 09/07→10/14								
 Hauptbremszylinder								
1.4 16V	70 - 72	09/07→10/14			- ESP		24.4123-1730.3 011097	Ø 23,8 ohne Bremsflüssigkeitsbehälter
1.6 16V	88 - 128	09/07→10/14						
1.6 Bioflex	82	03/09→10/14						
1.6 HDi	66 - 84	09/07→10/14						
1.6 THP 16V	115	10/09→10/14						
2.0	103	01/08→12/11						
2.0 Bioflex	103	01/08→12/11						
2.0 HDi	100 - 120	09/07→10/14						
PEUGEOT - 308 SW I Kasten/Kombi (4E_) 01/08→12/12								
 Hauptbremszylinder								
1.6 HDi	66 - 80	01/08→12/12			- ESP		24.4123-1730.3 011097	Ø 23,8 ohne Bremsflüssigkeitsbehälter
2.0 HDi	100	01/08→12/11						
PEUGEOT - 308 SW II (LC_, LJ_, LR_, LX_, L4_) 03/14→06/21								
 Hauptbremszylinder								
1.2 THP 110	81	03/14→06/21			08/14→		24.4155-1311.3 011053	ATE Ø 25,4 ohne Bremsflüssigkeitsbehälter
1.2 THP 130	96	03/14→06/21					24.4155-1311.3 011053	ATE Ø 25,4 ohne Bremsflüssigkeitsbehälter
1.5 BlueHDi 100	75	04/18→06/21						
1.5 BlueHDi 130	96	06/17→06/21						
1.6 BlueHDi 100	73	04/14→06/21						
1.6 BlueHDi 120	88	03/14→06/21						
1.6 GT 205	151	02/15→06/21						
1.6 HDi / BlueHDi 115	85	03/14→06/21						
1.6 HDi 92	68	03/14→06/21						
1.6 PureTech 225	165	01/18→06/21						
1.6 THP 125	92	03/14→06/21						
1.6 THP 150	110	03/14→06/21						
1.6 THP 155	115	03/14→06/21						
1.6 VTi	85	03/14→06/21						
2.0 BlueHDi 150	110	03/14→06/21						
2.0 GT BlueHDi 180	130 - 132	06/17→06/21						
2.0 GT HDi 180 / BlueHDi 180	133	06/14→06/21						
PEUGEOT - 308 SW II Kasten/Kombi (LC_) 04/14→								
 Hauptbremszylinder								
1.5 BlueHDi 130	96	06/17→06/21					24.4155-1311.3 011053	ATE Ø 25,4 ohne Bremsflüssigkeitsbehälter
1.6 BlueHDi	73	04/14→06/21						
PEUGEOT - 406 (8B) 08/95→01/05								
 Bremskraftverstärker								
1.6	65	11/95→05/04			Orga 08701→; → 04/04; für Linkslenker		03.7863-2804.4 300324	ATE Ø 10" pneumatisch
1.8	74	10/96→03/99			Orga 08701→; für Linkslenker		03.7863-2804.4 300324	ATE Ø 10" pneumatisch
1.8 16V	81	11/95→10/00						
1.8 16V	85	10/00→05/04			für Linkslenker		03.7863-2804.4 300324	ATE Ø 10" pneumatisch
1.8 BiFuel	85	09/00→05/04						
1.8 Bifuel	81	04/99→05/03			Orga 08701→; → 10/00; für Linkslenker		03.7863-2804.4 300324	ATE Ø 10" pneumatisch
2.0	104	11/96→03/99			Orga 08701→; - ESP; für Linkslenker		03.7863-2804.4 300324	ATE Ø 10" pneumatisch
2.0 HDI 110	80	06/98→08/01			Orga 08701→; + ESP; für Linkslenker		03.7863-2804.4 300324	ATE Ø 10" pneumatisch
2.0 16V	97 - 100	11/95→06/04			Orga 08701→; → 04/04; + ESP; für Linkslenker		03.7863-2804.4 300324	ATE Ø 10" pneumatisch
2.0 HDi 90	66	02/99→05/04						
2.0 Turbo	108	04/96→05/04			Orga 08701→; → 04/04; - ESP; für Linkslenker		03.7863-2804.4 300324	ATE Ø 10" pneumatisch
2.2	116	07/00→05/04						
2.2 HDi	98	03/00→05/04						
2.0 16V HPi	103	05/01→05/04			→ 04/04; - ESP; für Linkslenker		03.7863-2804.4 300324	ATE Ø 10" pneumatisch
2.0 HDi 110	79	08/01→05/04			→ 04/04; + ESP; für Linkslenker		03.7863-2804.4 300324	ATE Ø 10" pneumatisch
 Hauptbremszylinder								
1.6	65	11/95→05/04			Orga 08701→; → 04/04		03.2123-2581.3 010613	ATE Ø 23,8
1.8	66	05/97→05/04			→ 01/99; - ABS		24.2123-1710.3 010504	Ø 23,8
1.9 D	55	10/96→05/04						
1.9 TD	66 - 68	01/96→05/04			→ 01/99; + ABS		24.2123-1713.3 010505	Ø 23,8
3.0 24V	140	10/96→05/04			02/99→; →Orga 08700; + ABS		24.2123-1741.3 010681	Ø 23,8
					02/99→; →Orga 08700; - ABS		24.2123-1751.3 010698	Ø 23,8
1.8	74	10/96→03/99			Orga 08701→		03.2123-2581.3 010613	ATE Ø 23,8
→								















	kw			 	! #		
PEUGEOT - 406 (8B) 08/95→01/05							
 Hauptbremszylinder							
1.8 16V 3.0 24V	81 143	11/95→10/00 01/98→06/99		→ 01/99; - ABS → 01/99; + ABS 02/99→; →Orga 08700; + ABS 02/99→; →Orga 08700; - ABS		24.2123-1710.3 010504 24.2123-1713.3 010505 24.2123-1741.3 010681 24.2123-1751.3 010698	Ø 23,8 Ø 23,8 Ø 23,8 Ø 23,8
1.8 16V 1.8 BiFuel 1.8 Bifuel	85 85 81	10/00→05/04 09/00→05/04 04/99→05/03		- ESP Orga 08701→; → 10/00 →Orga 08700; + ABS →Orga 08700; - ABS		03.2123-2581.3 010613 03.2123-2581.3 010613 24.2123-1741.3 010681 24.2123-1751.3 010698	ATE Ø 23,8 ATE Ø 23,8 Ø 23,8 Ø 23,8
2.0 2.0 Turbo 2.1 TD 12V	104 108 80	11/96→03/99 04/96→05/04 01/96→05/04		→ 01/99; - ABS → 01/99; + ABS 02/99→; →Orga 08700; + ABS 02/99→; →Orga 08700; - ABS		24.2123-1710.3 010504 24.2123-1713.3 010505 24.2123-1741.3 010681 24.2123-1751.3 010698	Ø 23,8 Ø 23,8 Ø 23,8 Ø 23,8
2.0 16V	97	11/95→05/04		Orga 08701→; → 04/04; - ESP → 01/99; - ABS → 01/99; + ABS 02/99→; →Orga 08700; + ABS 02/99→; →Orga 08700; - ABS		03.2123-2581.3 010613 24.2123-1710.3 010504 24.2123-1713.3 010505 24.2123-1741.3 010681 24.2123-1751.3 010698	ATE Ø 23,8 Ø 23,8 Ø 23,8 Ø 23,8 Ø 23,8
2.0 16V	99	01/99→08/00		02/99→; + ABS 02/99→; - ABS		24.2123-1741.3 010681 24.2123-1751.3 010698	Ø 23,8 Ø 23,8
2.0 16V 2.0 HDI 90 2.2 2.2 HDi	100 66 116 98	08/00→06/04 02/99→05/04 07/00→05/04 03/00→05/04		Orga 08701→; → 04/04; - ESP →Orga 08700; + ABS →Orga 08700; - ABS		03.2123-2581.3 010613 24.2123-1741.3 010681 24.2123-1751.3 010698	ATE Ø 23,8 Ø 23,8 Ø 23,8 Ø 23,8
2.0 16V HPi 2.0 HDi 110	103 79	05/01→05/04 08/01→05/04		→ 04/04; - ESP		03.2123-2581.3 010613	ATE Ø 23,8
2.0 HDI 110	80	06/98→08/01		Orga 08701→; - ESP 02/99→; →Orga 08700; + ABS 02/99→; →Orga 08700; - ABS		03.2123-2581.3 010613 24.2123-1741.3 010681 24.2123-1751.3 010698	ATE Ø 23,8 Ø 23,8 Ø 23,8
3.0 V6	152	03/00→05/04		Orga 08701→; → 04/04 →Orga 08700; + ABS →Orga 08700; - ABS		03.2123-2581.3 010613 24.2123-1741.3 010681 24.2123-1751.3 010698	ATE Ø 23,8 Ø 23,8 Ø 23,8
PEUGEOT - 406 Break (8E/F) 10/96→10/04							
 Bremskraftverstärker							
1.8 1.9 D 1.9 TD	66 55 66	05/97→10/04 10/96→10/04 10/96→10/04		Orga 08701→; → 04/04; für Linkslenker		03.7863-2804.4 300324	ATE Ø 10" pneumatisch
1.8 1.8 16V	74 81	10/96→03/99 10/96→10/00		Orga 08701→; für Linkslenker		03.7863-2804.4 300324	ATE Ø 10" pneumatisch
1.8 16V 1.8 BiFuel	85 85	10/00→10/04 10/00→02/04		→ 04/04; für Linkslenker für Linkslenker		03.7863-2804.4 300324 03.7863-2804.4 300324	ATE Ø 10" pneumatisch ATE Ø 10" pneumatisch
2.0 2.0 16V	104 99	11/96→03/99 01/99→10/00		Orga 08701→; - ESP; für Linkslenker Orga 08701→; + ESP; für Linkslenker		03.7863-2804.4 300324 03.7863-2804.4 300324	ATE Ø 10" pneumatisch ATE Ø 10" pneumatisch
2.0 16V 2.0 HDI 90 2.0 Turbo 2.2 2.2 HDi	97 66 108 116 98	10/96→10/04 02/99→10/04 10/96→10/04 07/00→10/04 03/00→10/04		Orga 08701→; → 04/04; - ESP; für Linkslenker Orga 08701→; → 04/04; + ESP; für Linkslenker		03.7863-2804.4 300324 03.7863-2804.4 300324	ATE Ø 10" pneumatisch ATE Ø 10" pneumatisch
2.0 16V 2.0 HDi 110	100 79	10/00→10/04 08/01→10/04		→ 04/04; - ESP; für Linkslenker → 04/04; + ESP; für Linkslenker		03.7863-2804.4 300324 03.7863-2804.4 300324	ATE Ø 10" pneumatisch ATE Ø 10" pneumatisch
2.0 16V HPi 2.0 HDi 110	103 80	05/01→10/04 02/99→04/04		→ 04/04; + ESP; für Linkslenker Orga 08701→; → 08/01; - ESP; für Linkslenker Orga 08701→; → 08/01; + ESP; für Linkslenker		03.7863-2804.4 300324 03.7863-2804.4 300324 03.7863-2804.4 300324	ATE Ø 10" pneumatisch ATE Ø 10" pneumatisch ATE Ø 10" pneumatisch
 Hauptbremszylinder							
1.8 1.9 D 1.9 TD 3.0 24V	66 55 66 140	05/97→10/04 10/96→10/04 10/96→10/04 10/96→10/04		Orga 08701→; → 04/04 → 01/99; - ABS → 01/99; + ABS 02/99→; →Orga 08700; + ABS 02/99→; →Orga 08700; - ABS		03.2123-2581.3 010613 24.2123-1710.3 010504 24.2123-1713.3 010505 24.2123-1741.3 010681 24.2123-1751.3 010698	ATE Ø 23,8 Ø 23,8 Ø 23,8 Ø 23,8 Ø 23,8
1.8 1.8 16V →	74 81	10/96→03/99 10/96→10/00		Orga 08701→ → 01/99; - ABS		03.2123-2581.3 010613 24.2123-1710.3 010504	ATE Ø 23,8 Ø 23,8





	kw					! #		
PEUGEOT - 406 Break (8E/F) 10/96→10/04								
 Hauptbremszylinder								
1.8	74	10/96→03/99		→ 01/99; + ABS		24.2123-1713.3	010505	Ø 23,8
1.8 16V	81	10/96→10/00		02/99→; →Orga 08700; + ABS		24.2123-1741.3	010681	Ø 23,8
				02/99→; →Orga 08700; - ABS		24.2123-1751.3	010698	Ø 23,8
1.8 16V	85	10/00→10/04		→ 04/04; - ESP		03.2123-2581.3	010613	ATE Ø 23,8
2.0 16V	100	10/00→10/04						
2.0 16V HPi	103	05/01→10/04						
2.0 HDi 110	79	08/01→10/04						
1.8 BiFuel	85	10/00→02/04		- ESP		03.2123-2581.3	010613	ATE Ø 23,8
2.0	104	11/96→03/99		Orga 08701→; - ESP		03.2123-2581.3	010613	ATE Ø 23,8
				→ 01/99; - ABS		24.2123-1710.3	010504	Ø 23,8
				→ 01/99; + ABS		24.2123-1713.3	010505	Ø 23,8
				02/99→; →Orga 08700; + ABS		24.2123-1741.3	010681	Ø 23,8
				02/99→; →Orga 08700; - ABS		24.2123-1751.3	010698	Ø 23,8
2.0 16V	97	10/96→10/04		Orga 08701→; → 04/04; - ESP		03.2123-2581.3	010613	ATE Ø 23,8
2.0 Turbo	108	10/96→10/04		→ 01/99; - ABS		24.2123-1710.3	010504	Ø 23,8
2.1 TD 12V	80	10/96→10/04		→ 01/99; + ABS		24.2123-1713.3	010505	Ø 23,8
				02/99→; →Orga 08700; + ABS		24.2123-1741.3	010681	Ø 23,8
				02/99→; →Orga 08700; - ABS		24.2123-1751.3	010698	Ø 23,8
2.0 16V	99	01/99→10/00		Orga 08701→; - ESP		03.2123-2581.3	010613	ATE Ø 23,8
				→Orga 08700; + ABS		24.2123-1741.3	010681	Ø 23,8
				→Orga 08700; - ABS		24.2123-1751.3	010698	Ø 23,8
2.0 HDi 110	80	02/99→04/04		Orga 08701→; → 08/01; - ESP		03.2123-2581.3	010613	ATE Ø 23,8
				→Orga 08700; + ABS		24.2123-1741.3	010681	Ø 23,8
				→Orga 08700; - ABS		24.2123-1751.3	010698	Ø 23,8
2.0 HDi 90	66	02/99→10/04		Orga 08701→; → 04/04; - ESP		03.2123-2581.3	010613	ATE Ø 23,8
2.2	116	07/00→10/04		→Orga 08700; + ABS		24.2123-1741.3	010681	Ø 23,8
2.2 HDi	98	03/00→10/04		→Orga 08700; - ABS		24.2123-1751.3	010698	Ø 23,8
3.0 V6	152	03/00→10/04		Orga 08701→; → 04/04		03.2123-2581.3	010613	ATE Ø 23,8
				→Orga 08700; + ABS		24.2123-1741.3	010681	Ø 23,8
				→Orga 08700; - ABS		24.2123-1751.3	010698	Ø 23,8
PEUGEOT - 406 Coupe (8C) 03/97→02/05								
 Bremskraftverstärker								
2.0 16V	97	03/97→12/04		Orga 08701→; - ESP; für Linkslenker		03.7863-2804.4	300324	ATE Ø 10" pneumatisch
	99			Orga 08701→; + ESP; für Linkslenker		03.7863-2804.4	300324	ATE Ø 10" pneumatisch
2.2 HDi	98	03/00→12/04						
2.0 16V	99	04/99→09/04		Orga 08701→; → 10/00; - ESP; für Linkslenker		03.7863-2804.4	300324	ATE Ø 10" pneumatisch
				Orga 08701→; → 10/00; + ESP; für Linkslenker		03.7863-2804.4	300324	ATE Ø 10" pneumatisch
2.0 16V	100	10/00→12/04		- ESP; für Linkslenker		03.7863-2804.4	300324	ATE Ø 10" pneumatisch
2.2	116	03/02→12/04		+ ESP; für Linkslenker		03.7863-2804.4	300324	ATE Ø 10" pneumatisch
 Hauptbremszylinder								
2.0 16V	97	03/97→12/04		Orga 08701→; - ESP		03.2123-2581.3	010613	ATE Ø 23,8
				→ 01/99; - ABS		24.2123-1710.3	010504	Ø 23,8
				→ 01/99; + ABS		24.2123-1713.3	010505	Ø 23,8
				02/99→; →Orga 08700; + ABS		24.2123-1741.3	010681	Ø 23,8
				02/99→; →Orga 08700; - ABS		24.2123-1751.3	010698	Ø 23,8
2.0 16V	99	01/99→10/00		Orga 08701→; - ESP		03.2123-2581.3	010613	ATE Ø 23,8
2.2 HDi	98	03/00→12/04		→Orga 08700; + ABS		24.2123-1741.3	010681	Ø 23,8
				→Orga 08700; - ABS		24.2123-1751.3	010698	Ø 23,8
2.0 16V	99	04/99→09/04		Orga 08701→; → 10/00; - ESP		03.2123-2581.3	010613	ATE Ø 23,8
				→Orga 08700; + ABS		24.2123-1741.3	010681	Ø 23,8
				→Orga 08700; - ABS		24.2123-1751.3	010698	Ø 23,8
2.0 16V	100	10/00→12/04		- ESP		03.2123-2581.3	010613	ATE Ø 23,8
2.2	116	03/02→12/04						
3.0 24V	143	05/97→06/99		Orga 08701→		03.2123-2581.3	010613	ATE Ø 23,8
3.0 V6 24V	140	03/97→12/04		→ 01/99; - ABS		24.2123-1710.3	010504	Ø 23,8
				→ 01/99; + ABS		24.2123-1713.3	010505	Ø 23,8
				02/99→; →Orga 08700; + ABS		24.2123-1741.3	010681	Ø 23,8
				02/99→; →Orga 08700; - ABS		24.2123-1751.3	010698	Ø 23,8
3.0 V6	152	03/00→12/04		Orga 08701→		03.2123-2581.3	010613	ATE Ø 23,8
→								

	kw					! #		
PEUGEOT - 406 Coupe (8C) 03/97→02/05								
 Hauptbremszylinder								
3.0 V6	152	03/00→12/04		→Orga 08700; + ABS		24.2123-1741.3	010681	Ø 23,8
				→Orga 08700; - ABS		24.2123-1751.3	010698	Ø 23,8
3.0 V6	154	03/99→06/01		Orga 08701→		03.2123-2581.3	010613	ATE Ø 23,8
				03/00→; →Orga 08700; + ABS		24.2123-1741.3	010681	Ø 23,8
				03/00→; →Orga 08700; - ABS		24.2123-1751.3	010698	Ø 23,8
PEUGEOT - 407 (6D_) 02/04→12/11								
 Bremskraftverstärker								
1.6 HDi 110	80	05/04→12/10		für Linkslenker; →Orga 11192		03.7860-3402.4	300217	ATE Ø 10" pneumatisch
1.8 16V	92	08/05→12/10		Orga 12047→; für Linkslenker		03.7860-8002.4	300258	ATE Ø 10" pneumatisch
2.0 16V	103	09/05→12/10						
	105							
2.0 Bioflex	103	09/07→02/11						
2.0 Flex	103	10/05→02/11						
2.0 HDi	93	11/04→10/07						
2.0 HDi 135	100	05/04→10/10						
2.2 HDi 170	125	03/06→12/10						
3.0	155	03/04→12/10						
1.8	85	03/04→07/05		für Linkslenker		03.7860-3402.4	300217	ATE Ø 10" pneumatisch
2.0	100	03/04→07/05						
2.0 HDi	120	06/09→12/10		für Linkslenker		03.7860-8002.4	300258	ATE Ø 10" pneumatisch
2.0 HDi	103	06/09→12/10		Orga 12047→; für Linkslenker		03.7860-8002.4	300258	ATE Ø 10" pneumatisch
2.2 HDi	120	03/06→12/10						
2.2	116	03/04→10/06		für Linkslenker; →Orga 11283		03.7860-3402.4	300217	ATE Ø 10" pneumatisch
2.2 16V	120	08/05→12/10						
2.7 HDi	150	10/05→12/10		→Orga 11073; für Linkslenker		03.7860-3402.4	300217	ATE Ø 10" pneumatisch
 Hauptbremszylinder								
1.6 HDi 110	80	05/04→12/10				24.2122-2171.3	011122	ATE Ø 22,2
1.8	85	03/04→07/05						
1.8 16V	92	08/05→12/10						
2.0	100	03/04→07/05						
2.0 16V	103	09/05→12/10						
	105							
2.0 Bioflex	103	09/07→02/11						
2.0 Flex	103	10/05→02/11						
2.0 HDi	103	06/09→12/10		Orga 12348→		03.2123-3131.3	010977	ATE Ø 23,8
	120							
2.2 HDi	120	03/06→12/10						
2.2 HDi 170	125	03/06→12/10						
3.0	155	03/04→12/10						
2.0 HDi	93	11/04→10/07		Orga 12348→		03.2123-3131.3	010977	ATE Ø 23,8
2.0 HDi 135	100	05/04→10/10		→Orga 11682		24.2122-2171.3	011122	ATE Ø 22,2
PEUGEOT - 407 Coupe (6C_) 10/05→								
 Bremskraftverstärker								
2.0 HDi	100	10/05→		07/07→; →Orga 11192; für Linkslenker		03.7860-3402.4	300217	ATE Ø 10" pneumatisch
				Orga 12047→; → 12/11; für Linkslenker		03.7860-8002.4	300258	ATE Ø 10" pneumatisch
2.0 HDi	120	06/09→		→ 12/11; für Linkslenker		03.7860-8002.4	300258	ATE Ø 10" pneumatisch
3.0 HDi	177	06/09→						
2.2 16V	120	10/05→		→Orga 11283; für Linkslenker		03.7860-3402.4	300217	ATE Ø 10" pneumatisch
2.7 HDi	150	10/05→		→Orga 11073; für Linkslenker		03.7860-3402.4	300217	ATE Ø 10" pneumatisch
3.0 V6	155	10/05→		→Orga 11192; für Linkslenker		03.7860-3402.4	300217	ATE Ø 10" pneumatisch
				Orga 12047→; → 12/11; für Linkslenker		03.7860-8002.4	300258	ATE Ø 10" pneumatisch
 Hauptbremszylinder								
2.0 HDi	100	10/05→		Orga 12348→; → 12/11		03.2123-3131.3	010977	ATE Ø 23,8
	120							
2.2 16V	120	10/05→						
3.0 HDi	177	06/09→						
3.0 V6	155	10/05→						
PEUGEOT - 407 SW (6E_, 6D_) 05/04→12/11								
 Bremskraftverstärker								
1.6 HDi 110	80	05/04→12/10		für Linkslenker; →Orga 11192		03.7860-3402.4	300217	ATE Ø 10" pneumatisch
1.8 16V	92	08/05→12/10		Orga 12047→; für Linkslenker		03.7860-8002.4	300258	ATE Ø 10" pneumatisch
2.0 16V	103	08/05→12/10						
2.0 Bioflex	103	01/08→12/10						
2.0 Flex	103	10/05→02/11						
2.0 HDi	93	11/04→10/07						
2.0 HDi 135	100	07/04→12/10						
2.2 HDi 170	125	03/06→12/10						
→								

















	kW					! #		
PEUGEOT - 407 SW (6E_, 6D_) 05/04→12/11								
 Bremskraftverstärker								
3.0	155	05/04→12/10		für Linkslenker; →Orga 11192		03.7860-3402.4	300217	ATE Ø 10" pneumatisch
				Orga 12047→; für Linkslenker		03.7860-8002.4	300258	ATE Ø 10" pneumatisch
1.8	85	05/04→07/05		für Linkslenker		03.7860-3402.4	300217	ATE Ø 10" pneumatisch
2.0	100	05/04→07/05						
2.0 HDi	103	08/08→12/10		Orga 12047→; für Linkslenker		03.7860-8002.4	300258	ATE Ø 10" pneumatisch
2.2 HDi	120	06/08→12/10						
2.0 HDi	120	06/09→12/10		für Linkslenker		03.7860-8002.4	300258	ATE Ø 10" pneumatisch
2.2	116	05/04→07/05		für Linkslenker; →Orga 11283		03.7860-3402.4	300217	ATE Ø 10" pneumatisch
2.2 16V	120	08/05→12/10						
2.7 HDi	150	10/05→12/10		→Orga 11073; für Linkslenker		03.7860-3402.4	300217	ATE Ø 10" pneumatisch
 Hauptbremszylinder								
1.6 HDi 110	80	05/04→12/10				24.2122-2171.3	011122	ATE Ø 22,2
1.8	85	05/04→07/05						
1.8 16V	92	08/05→12/10						
2.0	100	05/04→07/05						
2.0 16V	103	08/05→12/10						
2.0 Bioflex	103	01/08→12/10						
2.0 Flex	103	10/05→02/11						
2.0 HDi	93	11/04→10/07		Orga 12348→		03.2123-3131.3	010977	ATE Ø 23,8
2.0 HDi 135	100	07/04→12/10		→Orga 11682		24.2122-2171.3	011122	ATE Ø 22,2
2.0 HDi	103 - 120	08/08→12/10		Orga 12348→		03.2123-3131.3	010977	ATE Ø 23,8
2.2 HDi	120	06/08→12/10						
2.2 HDi 170	125	03/06→12/10						
3.0	155	05/04→12/10						
PEUGEOT - 407 SW Kasten/Kombi (6E_) 08/04→12/10								
 Bremskraftverstärker								
1.6 HDi	80	08/04→12/10		für Linkslenker; →Orga 11192		03.7860-3402.4	300217	ATE Ø 10" pneumatisch
				Orga 12047→; für Linkslenker		03.7860-8002.4	300258	ATE Ø 10" pneumatisch
2.0 HDi	103	06/09→12/10		Orga 12047→; für Linkslenker		03.7860-8002.4	300258	ATE Ø 10" pneumatisch
2.0 HDi	120	06/09→12/10		für Linkslenker		03.7860-8002.4	300258	ATE Ø 10" pneumatisch
 Hauptbremszylinder								
1.6 HDi	80	08/04→12/10				24.2122-2171.3	011122	ATE Ø 22,2
2.0 HDi	103 - 120	06/09→12/10		Orga 12348→		03.2123-3131.3	010977	ATE Ø 23,8
PEUGEOT - 508 I (8D_) 11/10→12/18								
 Bremskraftverstärker								
1.6 HDi	82 - 85	11/10→12/18		für Linkslenker; für Fahrzeuge ohne Start-Stopp-Funktion; + DSC		03.7860-7802.4	300280	ATE Ø 10" pneumatisch
1.6 THP	115	11/10→12/18		für Linkslenker; + DSC		03.7860-7802.4	300280	ATE Ø 10" pneumatisch
1.6 VTi	85 - 88	11/10→12/18						
2.0 HDi	100 - 120	11/10→12/18						
2.2 HDi	150	11/10→12/18						
 Hauptbremszylinder								
1.6 BlueHDi 120	88	03/14→12/18		+ DSC		03.2123-3131.3	010977	ATE Ø 23,8
1.6 HDi	82 - 85	11/10→12/18		- DSC		03.2123-3641.3	010963	ATE Ø 23,8
1.6 THP	110 - 121	11/10→12/18						
1.6 VTi	85 - 88	11/10→12/18						
2.0 BlueHDi 150	110	04/14→12/18						
2.0 BlueHDi 180	133	04/14→12/18						
2.0 HDi	100 - 120	11/10→12/18						
2.2 HDi	150	11/10→12/18						
2.0 HDi Hybrid4 AWC	147	11/10→12/18		06/12→; + DSC		03.2123-3131.3	010977	ATE Ø 23,8
				06/12→; - DSC		03.2123-3641.3	010963	ATE Ø 23,8
PEUGEOT - 508 SW I (8E_) 11/10→12/18								
 Bremskraftverstärker								
1.6 HDi	82 - 85	11/10→12/18		für Linkslenker; für Fahrzeuge ohne Start-Stopp-Funktion; + DSC		03.7860-7802.4	300280	ATE Ø 10" pneumatisch
1.6 THP	115	11/10→12/18		für Linkslenker; + DSC		03.7860-7802.4	300280	ATE Ø 10" pneumatisch
→								



















	kw					! #		
PEUGEOT - 508 SW I (8E_) 11/10→12/18								
 Bremskraftverstärker								
1.6 VTi	85 - 88	11/10→12/18		für Linkslenker; + DSC		03.7860-7802.4	300280	ATE Ø 10" pneumatisch
2.0 HDi	100 - 120	11/10→12/18						
2.0 HDi RXH Hybrid4	147	11/10→12/18						
2.2 HDi	150	11/10→12/18						
 Hauptbremszylinder								
1.6	121	02/12→12/18		+ DSC		03.2123-3131.3	010977	ATE Ø 23,8
1.6 BlueHDi 120	88	03/14→12/18		- DSC		03.2123-3641.3	010963	ATE Ø 23,8
1.6 HDi	82 - 85	11/10→12/18						
1.6 THP	110 - 115	11/10→12/18						
1.6 VTi	85 - 88	11/10→12/18						
2.0 BlueHDi 150	110	04/14→12/18						
2.0 BlueHDi 180	133	04/14→12/18						
2.0 HDi	100 - 120	11/10→12/18						
2.0 HDi 180 RXH	133	10/14→12/18						
2.0 HDi RXH Hybrid4	147	11/10→12/18						
2.2 HDi	150	11/10→12/18						
PEUGEOT - 508 SW Kasten/Kombi (8E_) 11/11→								
 Bremskraftverstärker								
1.6 HDi	84	03/13→12/18		für Linkslenker; für Fahrzeuge ohne Start-Stopp-Funktion; + DSC		03.7860-7802.4	300280	ATE Ø 10" pneumatisch
2.0 HDi	103 - 120	03/13→12/18		für Linkslenker; + DSC		03.7860-7802.4	300280	ATE Ø 10" pneumatisch
2.2 HDi	150	11/11→						
 Hauptbremszylinder								
1.6 HDi	84	03/13→12/18		+ DSC		03.2123-3131.3	010977	ATE Ø 23,8
2.0 HDi	103 - 120	03/13→12/18		- DSC		03.2123-3641.3	010963	ATE Ø 23,8
2.2 HDi	150	11/11→						
PEUGEOT - 605 (6B) 06/89→09/99								
 Hauptbremszylinder								
2.0	79 - 89	06/89→09/99		04/90→; - ABS		24.2122-1703.3	010422	Ø 22,2
				04/90→; + ABS		24.2122-1708.3	010437	Ø 22,2
2.0 16V	97	07/94→09/99		09/94→; →Orga 07692; - ABS		24.2122-1703.3	010422	Ø 22,2
				Orga 07693→		24.2122-1708.3	010437	Ø 22,2
				09/94→; →Orga 07692; + ABS		24.2122-1708.3	010437	Ø 22,2
2.1 TD 12V	80	08/94→09/99		- ABS		24.2122-1703.3	010422	Ø 22,2
				+ ABS		24.2122-1708.3	010437	Ø 22,2
2.1 Turbo Diesel	80	06/89→09/99		10/90→; - ABS		24.2122-1703.3	010422	Ø 22,2
				10/90→; + ABS		24.2122-1708.3	010437	Ø 22,2
3.0	123	10/89→09/99		04/90→ 08/94; - ABS		24.2122-1703.3	010422	Ø 22,2
PEUGEOT - 806 (221) 06/94→08/02								
 Hauptbremszylinder								
1.8	73	07/95→08/02		10/96→; →Orga 08206; - ABS		24.2122-1703.3	010422	Ø 22,2
				10/96→; →Orga 08206; + ABS		24.2122-1708.3	010437	Ø 22,2
				Orga 08207→; → 06/02; - ABS		24.2122-1741.3	010695	Ø 22,2
1.9 TD	66 - 68	07/95→08/02		→Orga 08206; - ABS		24.2123-1707.3	010492	Ø 23,8
2.0 16V	100	09/00→08/02		Orga 08207→; → 06/02; + ABS		24.2123-1733.3	010657	BOS Ø 23,8
				Orga 08207→; → 06/02; - ABS		24.2123-1738.3	010658	Ø 23,8
2.0	89	06/94→08/02		08/94→; →Orga 08206; - ABS		24.2123-1707.3	010492	Ø 23,8
2.0 Turbo	108	06/94→08/02		Orga 08207→; → 06/02; + ABS		24.2123-1733.3	010657	BOS Ø 23,8
				Orga 08207→; → 06/02; - ABS		24.2123-1738.3	010658	Ø 23,8
2.0 16V	97	05/98→09/00		10/98→; →Orga 08206; - ABS		24.2123-1707.3	010492	Ø 23,8
				Orga 08207→; + ABS		24.2123-1733.3	010657	BOS Ø 23,8
				Orga 08207→; - ABS		24.2123-1738.3	010658	Ø 23,8
2.0 HDi	80	08/99→08/02		→ 06/02; + ABS		24.2123-1733.3	010657	BOS Ø 23,8
2.0 HDi 16V	80	08/99→08/02		→ 06/02; - ABS		24.2123-1738.3	010658	Ø 23,8
2.1 td 12V	80	06/96→08/99		→Orga 08206; - ABS		24.2123-1707.3	010492	Ø 23,8
				Orga 08207→; + ABS		24.2123-1733.3	010657	BOS Ø 23,8













	kw					! #		
PEUGEOT - 806 (221) 06/94 → 08/02								
 Hauptbremszylinder								
2.1 td 12V	80	06/96 → 08/99		Orga 08207 →; - ABS			24.2123-1738.3 010658	Ø 23,8
PEUGEOT - 807 (EB_) 06/02 →								
 Bremskraftverstärker								
2.0 2.0 HDi 2.2	100 100 116	06/02 → 06/06 → 06/02 →		Orga 10528 →; für Linkslenker; → 06/14			03.7860-2002.4 300216	ATE Ø 10" pneumatisch
2.0 16V 2.0 HDi 2.2 HDi	103 88 94	09/05 → 02/06 → 06/02 →		10528 → 10919; für Linkslenker			03.7860-2002.4 300216	ATE Ø 10" pneumatisch
				Orga 10920 →; für Linkslenker; → 06/14			03.7860-4432.4 300313	ATE Ø 10" pneumatisch
2.0 HDi 2.2 HDi	79 100	06/02 → 05/06 04/04 → 05/06		10528 → 10919; für Linkslenker			03.7860-2002.4 300216	ATE Ø 10" pneumatisch
				Orga 10920 →; für Linkslenker			03.7860-4432.4 300313	ATE Ø 10" pneumatisch
2.0 HDi	80	04/04 →		10528 → 10919; für Linkslenker			03.7860-2002.4 300216	ATE Ø 10" pneumatisch
				Orga 10920 →; → 05/06; für Linkslenker			03.7860-4432.4 300313	ATE Ø 10" pneumatisch
 Hauptbremszylinder								
2.0 2.0 HDi 2.2 2.2 HDi	100 88 116 94	06/02 → 02/06 → 06/02 → 06/02 →		Orga 10528 →; → 06/14			03.2122-2163.3 010800	ATE Ø 22,2
2.0 16V 2.0 HDi	103 100	09/05 → 06/06 →		→ 06/14			03.2122-2163.3 010800	ATE Ø 22,2
2.0 HDi 2.2 HDi	79 100	06/02 → 05/06 04/04 → 05/06		Orga 10528 →			03.2122-2163.3 010800	ATE Ø 22,2
2.0 HDi	80	04/04 →		Orga 10528 →; → 05/06			03.2122-2163.3 010800	ATE Ø 22,2
2.0 HDi	120	06/09 →		→ 06/14			03.2123-3421.3 010933	ATE Ø 23,8
2.2 HDi	120	06/06 →		10/07 → 06/14			03.2123-3421.3 010933	ATE Ø 23,8
2.2 HDi	125	06/06 → 06/10		10/07 →			03.2123-3421.3 010933	ATE Ø 23,8
PEUGEOT - 807 Van (EB_) 06/02 →								
 Bremskraftverstärker								
2.0 HDi HDi	79 - 80 94	06/02 → 05/06 04/04 → 05/06		10528 → 10919; für Linkslenker			03.7860-2002.4 300216	ATE Ø 10" pneumatisch
				Orga 10920 →; für Linkslenker			03.7860-4432.4 300313	ATE Ø 10" pneumatisch
 Hauptbremszylinder								
2.0 HDi	120	05/10 →					03.2123-3421.3 010933	ATE Ø 23,8
2.0 HDi HDi	79 - 80 94	06/02 → 05/06 04/04 → 05/06		Orga 10528 →			03.2122-2163.3 010800	ATE Ø 22,2
PEUGEOT - 1007 (KM_) 04/05 →								
 Hauptbremszylinder								
1.4 1.4 16V 1.4 HDi 1.6 16V	54 65 50 80	04/05 → 10/05 → 04/05 → 04/05 →		→ Orga 11009; - DSC			24.2122-1764.3 010851	BOS Ø 22,2
							24.2122-1766.3 010840	TRW Ø 22,2
				→ Orga 11009; + DSC			24.2122-1767.3 010841	TRW Ø 22,2 ohne Drucksensor
				Orga 11010 →; → 02/11; + DSC			24.4122-1703.3 010843	TRW Ø 22,2
				Orga 11010 →; → 02/11; - DSC			24.4122-1704.3 010847	TRW Ø 22,2
1.6 HDi	80	06/07 →		→ 02/11; + DSC			24.4122-1703.3 010843	TRW Ø 22,2
				→ 02/11; - DSC			24.4122-1704.3 010847	TRW Ø 22,2
PEUGEOT - 2008 I (CU_) 03/13 →								
 Hauptbremszylinder								
1.2 PureTech 82 1.2 VTi	61 60	01/18 → 12/19 03/13 → 12/18		Orga 13384 →			24.4123-1704.3 010828	TRW Ø 23,8
1.2 THP 110 / PureTech 110 1.2 THP 130 / PureTech 130 1.4 HDi 1.5 BlueHDi 100 1.5 BlueHDi 120 1.6 BlueHDi 1.6 BlueHDi 100 1.6 BlueHDi 120 1.6 BlueHDi 75 1.6 HDi 1.6 THP 165 1.6 VTi	81 96 50 75 88 85 73 88 55 68 - 84 121 85 - 88	01/15 → 01/15 → 06/13 → 05/18 → 05/18 → 07/14 → 01/15 → 07/14 → 01/15 → 03/13 → 03/13 → 02/16 → 03/13 → 03/13 →					24.4123-1704.3 010828	TRW Ø 23,8











	kw			 	! #		
PEUGEOT - 2008 I Van (CU_) 03/13→							
 Hauptbremszylinder							
BlueHDi 100	75	05/18→				24.4123-1704.3	010828 TRW Ø 23,8
BlueHDi 120	88	05/18→					
PureTech 130	96	01/18→					
PEUGEOT - 3008 Großraumlimousine (0U_) 05/09→12/17							
 Bremskraftverstärker							
1.6 HDi	82	12/09→08/16		Orga 12621→; für Fahrzeuge mit Start-Stopp-Funktion		03.7860-3734.4	300317 ATE Ø 10" pneumatisch
1.6 HDi	84	03/13→08/16		für Fahrzeuge mit Start-Stopp-Funktion		03.7860-3734.4	300317 ATE Ø 10" pneumatisch
1.6 Turbo	121	05/14→08/16				03.7860-3734.4	300317 ATE Ø 10" pneumatisch
2.0 HDi Hybrid4	147	02/11→08/16					
 Hauptbremszylinder							
1.2	96	01/15→08/16				03.4153-0173.3	010815 ATE Ø 23,8
1.6 BlueHDi 120	88	05/14→08/16					
1.6 HDi	80	06/09→08/16					
	84						
1.6 HDi 115 / BlueHDi 115	85	02/13→08/16					
1.6 THP	110	06/09→08/16					
	120						
1.6 Turbo	121	05/14→08/16					
1.6 VTi	88	06/09→08/16					
2.0 HDi	100	06/09→08/16					
	120						
2.0 HDi 150 / BlueHDi 150	110	06/09→08/16					
2.0 HDi Hybrid4	147	02/11→08/16					
PEUGEOT - 3008 Van (0U_) 05/09→12/17							
 Hauptbremszylinder							
HDi	120	06/09→08/16				03.4153-0173.3	010815 ATE Ø 23,8
HDi 110	80	06/09→08/16					
HDi 150	110	06/09→08/16					
PEUGEOT - 5008 (0U_, 0E_) 06/09→03/17							
 Bremskraftverstärker							
1.6 BlueHDi 115	85	11/14→03/17		für Fahrzeuge mit Start-Stopp-Funktion		03.7860-3734.4	300317 ATE Ø 10" pneumatisch
1.6 BlueHDi 120	88	05/14→03/17					
1.6 HDi	84	03/13→03/17					
1.6 HDi	82	08/10→03/17		Orga 12656→; für Fahrzeuge mit Start-Stopp-Funktion		03.7860-3734.4	300317 ATE Ø 10" pneumatisch
 Hauptbremszylinder							
1.2	96	01/15→03/17				03.4153-0173.3	010815 ATE Ø 23,8
1.6 16V	88	09/09→03/17					
	115						
1.6 HDi	80	09/09→03/17					
	84						
2.0 HDi	120	09/09→03/17					
2.0 HDi 136 / BlueHDi 136	100	02/12→03/17					
2.0 HDi 150 / BlueHDi 150	110	06/09→03/17		09/09→		03.4153-0173.3	010815 ATE Ø 23,8
PEUGEOT - 5008 I Van (0U_) 06/09→03/17							
 Bremskraftverstärker							
HDi / e-HDi	84	03/13→03/17		für Fahrzeuge mit Start-Stopp-Funktion		03.7860-3734.4	300317 ATE Ø 10" pneumatisch
HDi	82	08/10→03/17		Orga 12656→; für Fahrzeuge mit Start-Stopp-Funktion		03.7860-3734.4	300317 ATE Ø 10" pneumatisch
 Hauptbremszylinder							
HDi / e-HDi	84	03/13→03/17				03.4153-0173.3	010815 ATE Ø 23,8
HDi	82	08/10→03/17					
HDi 136	100	02/12→03/17					
HDi 150	110	06/09→03/17					
HDi 165	120	06/09→03/17					
PEUGEOT - BOXER Bus 09/05→							
 Hauptbremszylinder							
2.2 HDi 100	74	04/06→		Nutzlast ab [kg] 1.200 Nutzlast bis [kg] 1.400; + DSC; nicht für Facelift; Nutzlast-Code: 12Q / 14Q		24.4125-1701.3	010867 BOS Ø 25,4 ohne Bremsflüssigkeitsbehälter
2.2 HDi 110	81	03/11→					
2.2 HDi 120	88	04/06→					
2.2 HDi 130	96	03/11→					
→							



	kw			 	! #		
PEUGEOT - BOXER Bus 09/05 →							
 Hauptbremszylinder							
2.2 HDi 150 2.8 HDi 3.0 HDi 145 3.0 HDi 160 3.0 HDi 175	110 93 107 115 130	03/11 → 09/05 → 09/09 04/10 → 12/13 04/06 → 12/15 03/11 →		Nutzlast ab [kg] 1.200 Nutzlast bis [kg] 1.400; - DSC; nicht für Facelift; Nutzlast-Code: 12Q / 14Q		24.4125-1702.3 010872	BOS Ø 25,4 ohne Bremsflüssigkeitsbehälter
				Nutzlast ab [kg] 1.600 Nutzlast bis [kg] 2.000; + DSC; nicht für Facelift; Nutzlast-Code: 16Q / 20Q		24.4126-1701.3 010868	BOS Ø 27 ohne Bremsflüssigkeitsbehälter
				Nutzlast ab [kg] 1.600 Nutzlast bis [kg] 2.000; - DSC; nicht für Facelift; Nutzlast-Code: 16Q / 20Q		24.4126-1702.3 010875	BOS Ø 27 ohne Bremsflüssigkeitsbehälter
PEUGEOT - BOXER Bus (230P) 03/94 → 12/09							
 Hauptbremszylinder							
1.9 D	51	03/94 → 04/02		→ S 15064995; Nutzlast [kg]: 1.000; für Linkslenker; - ABS		24.2122-1715.3 010481	Ø 22,2
				S 15064996 → S 16206253; Nutzlast [kg]: 1.000; + ABS		24.2125-1702.3 010482	Ø 25,4
				S 15064996 → S 16205754; Nutzlast [kg]: 1.000; für Linkslenker; - ABS		24.2125-1703.3 010483	Ø 25,4
				S 16206254 →; → 03/02; Nutzlast [kg]: 1.000; + ABS		24.2125-1726.3 010718	Ø 25,4
1.9 TD 1.9 TD 4x4	66 - 68 68	03/94 → 04/02 07/96 → 04/02		→ S 15064995; Nutzlast ab [kg] 1.000 Nutzlast bis [kg] 1.400; für Linkslenker; - ABS		24.2122-1715.3 010481	Ø 22,2
				S 15064996 → S 16206253; Nutzlast ab [kg] 1.000 Nutzlast bis [kg] 1.400; + ABS		24.2125-1702.3 010482	Ø 25,4
				S 15064996 → S 16205754; Nutzlast ab [kg] 1.000 Nutzlast bis [kg] 1.400; für Linkslenker; - ABS		24.2125-1703.3 010483	Ø 25,4
				S 16206254 →; → 03/02; Nutzlast ab [kg] 1.000 Nutzlast bis [kg] 1.400; + ABS		24.2125-1726.3 010718	Ø 25,4
2.0 i 2.0 i 4x4	80 80	03/94 → 04/02 08/96 → 04/02		→ S 15064995; Nutzlast ab [kg] 1.000 Nutzlast bis [kg] 1.400; für Linkslenker; - ABS		24.2122-1715.3 010481	Ø 22,2
				S 15064996 → S 16206253; Nutzlast ab [kg] 1.000 Nutzlast bis [kg] 1.400; + ABS		24.2125-1702.3 010482	Ø 25,4
				→ S 16194399; Nutzlast [kg]: 1.800; + ABS		24.2125-1702.3 010482	Ø 25,4
				→ S 16205352; Nutzlast [kg]: 1.800; für Linkslenker; - ABS		24.2125-1703.3 010483	Ø 25,4
				S 15064996 → S 16205754; Nutzlast ab [kg] 1.000 Nutzlast bis [kg] 1.400; für Linkslenker; - ABS		24.2125-1703.3 010483	Ø 25,4
				S 16206254 →; → 03/02; Nutzlast ab [kg] 1.000 Nutzlast bis [kg] 1.400; + ABS		24.2125-1726.3 010718	Ø 25,4
				S 16194400 →; → 03/02; Nutzlast [kg]: 1.800; + ABS		24.2125-1726.3 010718	Ø 25,4
2.5 D 2.5 D 4x4	63 63	08/94 → 04/02 07/96 → 04/02		→ S 15064995; Nutzlast [kg]: 1.400; für Linkslenker; - ABS		24.2122-1715.3 010481	Ø 22,2
				→ S 16194399; Nutzlast [kg]: 1.800; + ABS		24.2125-1702.3 010482	Ø 25,4
				S 15064996 → S 16206253; Nutzlast [kg]: 1.400; + ABS		24.2125-1702.3 010482	Ø 25,4
				→ S 16205352; Nutzlast [kg]: 1.800; für Linkslenker; - ABS		24.2125-1703.3 010483	Ø 25,4
				S 15064996 → S 16205754; Nutzlast [kg]: 1.400; für Linkslenker; + ABS		24.2125-1703.3 010483	Ø 25,4
				S 16206254 →; → 03/02; Nutzlast [kg]: 1.400; + ABS		24.2125-1726.3 010718	Ø 25,4
				S 16194400 →; → 03/02; Nutzlast [kg]: 1.800; + ABS		24.2125-1726.3 010718	Ø 25,4
2.5 DT	62	10/97 → 11/01		→ S 15064995; Nutzlast [kg]: 1.400; für Linkslenker; - ABS		24.2122-1715.3 010481	Ø 22,2
				→ S 16194399; Nutzlast [kg]: 1.800; + ABS		24.2125-1702.3 010482	Ø 25,4
				S 15064996 → S 16206253; Nutzlast [kg]: 1.400; + ABS		24.2125-1702.3 010482	Ø 25,4
				→ S 16205352; Nutzlast [kg]: 1.800; für Linkslenker; - ABS		24.2125-1703.3 010483	Ø 25,4
				S 15064996 → S 16205754; Nutzlast [kg]: 1.400; für Linkslenker; + ABS		24.2125-1703.3 010483	Ø 25,4
				S 16206254 →; Nutzlast [kg]: 1.400; + ABS		24.2125-1726.3 010718	Ø 25,4
				S 16194400 →; Nutzlast [kg]: 1.800; + ABS		24.2125-1726.3 010718	Ø 25,4
→							









	kw			 	! #		
PEUGEOT - BOXER Bus (230P) 03/94→12/09							
 Hauptbremszylinder							
2.5 TD 4x4	76	07/96→04/02	→ S 15064995; Nutzlast [kg]: 1.400; für Linkslenker; - ABS	24.2122-1715.3	010481	Ø 22,2	
			→ S 16194399; Nutzlast [kg]: 1.800; + ABS	24.2125-1702.3	010482	Ø 25,4	
			S 15064996→ S 16206253; Nutzlast [kg]: 1.400; + ABS	24.2125-1702.3	010482	Ø 25,4	
			→ S 16205352; Nutzlast [kg]: 1.800; für Linkslenker; - ABS	24.2125-1703.3	010483	Ø 25,4	
			S 15064996→ S 16205754; Nutzlast [kg]: 1.400; für Linkslenker; - ABS	24.2125-1703.3	010483	Ø 25,4	
			S 16206254→; → 03/02; Nutzlast [kg]: 1.400; + ABS	24.2125-1726.3	010718	Ø 25,4	
			S 16194400→; → 03/02; Nutzlast [kg]: 1.800; + ABS	24.2125-1726.3	010718	Ø 25,4	
2.5 TDI 2.5 TDI 4x4	79	01/97→04/02	→ S 16206253; Nutzlast [kg]: 1.400; + ABS	24.2125-1702.3	010482	Ø 25,4	
			→ S 16194399; Nutzlast [kg]: 1.800; + ABS	24.2125-1702.3	010482	Ø 25,4	
			→ S 16205352; Nutzlast [kg]: 1.800; für Linkslenker; - ABS	24.2125-1703.3	010483	Ø 25,4	
			S 15064996→ S 16205754; Nutzlast [kg]: 1.400; für Linkslenker; - ABS	24.2125-1703.3	010483	Ø 25,4	
			S 16194400→; → 03/02; Nutzlast [kg]: 1.800; + ABS	24.2125-1726.3	010718	Ø 25,4	
			S 16206254→; → 03/02; Nutzlast [kg]: 1.400; + ABS	24.2125-1726.3	010718	Ø 25,4	
2.8 D	64	01/99→02/02	→ S 15064995; Nutzlast [kg]: 1.400; für Linkslenker; - ABS	24.2122-1715.3	010481	Ø 22,2	
			→ S 16194399; Nutzlast [kg]: 1.800; + ABS	24.2125-1702.3	010482	Ø 25,4	
			S 15064995→ S 16206253; Nutzlast [kg]: 1.400; + ABS	24.2125-1702.3	010482	Ø 25,4	
			→ S 16205352; Nutzlast [kg]: 1.800; für Linkslenker; - ABS	24.2125-1703.3	010483	Ø 25,4	
			S 15064996→ S 16205754; Nutzlast [kg]: 1.400; für Linkslenker; - ABS	24.2125-1703.3	010483	Ø 25,4	
			S 16206254→; Nutzlast [kg]: 1.400; + ABS	24.2125-1726.3	010718	Ø 25,4	
			S 16194400→; Nutzlast [kg]: 1.800; + ABS	24.2125-1726.3	010718	Ø 25,4	
2.8 HDI	94	11/00→04/02	→ S 16206253; Nutzlast [kg]: 1.400; + ABS	24.2125-1702.3	010482	Ø 25,4	
			→ S 16194399; Nutzlast [kg]: 1.800; + ABS	24.2125-1702.3	010482	Ø 25,4	
			→ S 16205352; Nutzlast [kg]: 1.800; für Linkslenker; - ABS	24.2125-1703.3	010483	Ø 25,4	
			→ S 16205754; Nutzlast [kg]: 1.400; für Linkslenker; - ABS	24.2125-1703.3	010483	Ø 25,4	
			S 16206254→; → 03/02; Nutzlast [kg]: 1.400; + ABS	24.2125-1726.3	010718	Ø 25,4	
			S 16194400→; → 03/02; Nutzlast [kg]: 1.800; + ABS	24.2125-1726.3	010718	Ø 25,4	
2.8 HDi 4x4	94	10/00→04/02	→ S 15064995; Nutzlast ab [kg] 1.000 Nutzlast bis [kg] 1.400; für Linkslenker; - ABS	24.2122-1715.3	010481	Ø 22,2	
			S 15064995→ S 16206253; Nutzlast ab [kg] 1.000 Nutzlast bis [kg] 1.400; + ABS	24.2125-1702.3	010482	Ø 25,4	
			→ S 16194399; Nutzlast [kg]: 1.800; + ABS	24.2125-1702.3	010482	Ø 25,4	
			→ S 16205352; Nutzlast [kg]: 1.800; für Linkslenker; - ABS	24.2125-1703.3	010483	Ø 25,4	
			S 15064996→ S 16205754; Nutzlast ab [kg] 1.000 Nutzlast bis [kg] 1.400; für Linkslenker; - ABS	24.2125-1703.3	010483	Ø 25,4	
			S 16206254→; → 03/02; Nutzlast ab [kg] 1.000 Nutzlast bis [kg] 1.400; + ABS	24.2125-1726.3	010718	Ø 25,4	
			S 16194400→; → 03/02; Nutzlast [kg]: 1.800; + ABS	24.2125-1726.3	010718	Ø 25,4	
2.8 HDi All-wheel Drive	93	10/00→11/01	→ S 15064995; Nutzlast ab [kg] 1.000 Nutzlast bis [kg] 1.400; für Linkslenker; - ABS	24.2122-1715.3	010481	Ø 22,2	
			S 15064995→ S 16206253; Nutzlast ab [kg] 1.000 Nutzlast bis [kg] 1.400; + ABS	24.2125-1702.3	010482	Ø 25,4	
			→ S 16194399; Nutzlast [kg]: 1.800; + ABS	24.2125-1702.3	010482	Ø 25,4	
→							













	kw					! #		
PEUGEOT - BOXER Bus (230P) 03/94→12/09								
 Hauptbremszylinder								
2.8 HDi All-wheel Drive	93	10/00→11/01		→ S 16205352; Nutzlast [kg]: 1.800; für Linkslenker; - ABS		24.2125-1703.3	010483	Ø 25,4
				S 15064996→ S 16205754; Nutzlast ab [kg] 1.000 Nutzlast bis [kg] 1.400; für Linkslenker; - ABS		24.2125-1703.3	010483	Ø 25,4
				S 16206254→; Nutzlast ab [kg] 1.000 Nutzlast bis [kg] 1.400; + ABS		24.2125-1726.3	010718	Ø 25,4
				S 16194400→; Nutzlast [kg]: 1.800; + ABS		24.2125-1726.3	010718	Ø 25,4
 Bremskraftregler								
1.9 D	51	03/94→04/02		→ S 16206244; Nutzlast [kg]: 1.000; - ABS		24.6512-1701.3	320153	lastabhängig 2x
1.9 TD	66	03/94→04/02		→ S 16206244; Nutzlast ab [kg] 1.000 Nutzlast bis [kg] 1.400; - ABS		24.6512-1701.3	320153	lastabhängig 2x
1.9 TD 4x4	68	07/96→04/02						
2.0 i	80	03/94→04/02		→ S 16206244; Nutzlast ab [kg] 1.000 Nutzlast bis [kg] 1.800; - ABS		24.6512-1701.3	320153	lastabhängig 2x
2.0 i 4x4	80	08/96→04/02						
2.5 TD 4x4	76	07/96→04/02		→ S 16206244; Nutzlast ab [kg] 1.400 Nutzlast bis [kg] 1.800; - ABS		24.6512-1701.3	320153	lastabhängig 2x
2.5 TDI	79	01/97→04/02						
2.5 TDI 4x4	79	01/97→04/02						
2.8 D	64	01/99→02/02						
2.8 HDi	94	11/00→04/02						
2.8 HDi	93	10/00→11/01		11/00→; → S 16206244; Nutzlast ab [kg] 1.400 Nutzlast bis [kg] 1.800; - ABS		24.6512-1701.3	320153	lastabhängig 2x
PEUGEOT - BOXER Bus (244, Z_) 12/01→								
 Hauptbremszylinder								
2.0	81	12/01→06/06		→ 03/06; Nutzlast ab [kg] 1.000 Nutzlast bis [kg] 1.800; + ABS		24.2125-1726.3	010718	Ø 25,4
2.0 HDi	62	12/01→06/06						
2.2 HDi	74	12/01→06/06						
2.8 HDi	94	12/01→06/06						
2.8 HDi 4x4	107							
2.0 BiFuel	81	12/01→06/06		04/02→ 03/06; Nutzlast ab [kg] 1.000 Nutzlast bis [kg] 1.800; + ABS		24.2125-1726.3	010718	Ø 25,4
2.8 HDi	90	03/02→08/05		Nutzlast ab [kg] 1.000 Nutzlast bis [kg] 1.800; + ABS		24.2125-1726.3	010718	Ø 25,4
 Bremskraftregler								
2.8 HDi 4x4	94	12/01→06/06		→ 03/06; Nutzlast ab [kg] 1.000 Nutzlast bis [kg] 1.800; - ABS		24.6512-1701.3	320153	lastabhängig 2x
PEUGEOT - BOXER Kasten 04/06→								
 Hauptbremszylinder								
2.2 HDi 100	74	04/06→		Nutzlast ab [kg] 1.200 Nutzlast bis [kg] 1.400; + DSC; nicht für Facelift; Nutzlast-Code: 12Q / 14Q		24.4125-1701.3	010867	BOS Ø 25,4 ohne Bremsflüssigkeitsbehälter
2.2 HDi 110	81	03/11→						
2.2 HDi 120	88	04/06→						
2.2 HDi 130	96	03/11→		Nutzlast ab [kg] 1.200 Nutzlast bis [kg] 1.400; - DSC; nicht für Facelift; Nutzlast-Code: 12Q / 14Q		24.4125-1702.3	010872	BOS Ø 25,4 ohne Bremsflüssigkeitsbehälter
2.2 HDi 130 4x4	96	03/11→						
2.2 HDi 150	110	03/11→						
2.2 HDi 150 4x4	110	03/11→						
3.0 HDi 145	107	04/10→12/13		Nutzlast ab [kg] 1.600 Nutzlast bis [kg] 2.000; + DSC; nicht für Facelift; Nutzlast-Code: 16Q / 20Q		24.4126-1701.3	010868	BOS Ø 27 ohne Bremsflüssigkeitsbehälter
3.0 HDi 155	115	07/06→12/15						
3.0 HDi 160	116	04/06→12/15						
3.0 HDi 175	130	03/11→		Nutzlast ab [kg] 1.600 Nutzlast bis [kg] 2.000; - DSC; nicht für Facelift; Nutzlast-Code: 16Q / 20Q		24.4126-1702.3	010875	BOS Ø 27 ohne Bremsflüssigkeitsbehälter
PEUGEOT - BOXER Kasten (230L) 03/94→08/06								
 Hauptbremszylinder								
1.9 D	50	07/99→04/02		→ S 16206253; Nutzlast [kg]: 1.000; + ABS		24.2125-1702.3	010482	Ø 25,4
				→ S 16205754; Nutzlast [kg]: 1.000; - ABS; für Linkslenker		24.2125-1703.3	010483	Ø 25,4
				S 16206254→; → 03/02; Nutzlast [kg]: 1.000; + ABS		24.2125-1726.3	010718	Ø 25,4
1.9 D	51	03/94→04/02		→ S 15064995; Nutzlast [kg]: 1.000; - ABS; für Linkslenker		24.2122-1715.3	010481	Ø 22,2
				S 15064996→ S 16206253; Nutzlast [kg]: 1.000; + ABS		24.2125-1702.3	010482	Ø 25,4
				S 15064996→ S 16205754; Nutzlast [kg]: 1.000; - ABS; für Linkslenker		24.2125-1703.3	010483	Ø 25,4
				S 16206254→; → 03/02; Nutzlast [kg]: 1.000; + ABS		24.2125-1726.3	010718	Ø 25,4
→								

	kw			 	! #		
PEUGEOT - BOXER Kasten (230L) 03/94→08/06							
 Hauptbremszylinder							
1.9 TD	66	07/99→04/02	→ S 16206253; Nutzlast ab [kg] 1.000 Nutzlast bis [kg] 1.400; + ABS	24.2125-1702.3	010482	Ø 25,4	
			→ S 16205754; Nutzlast ab [kg] 1.000 Nutzlast bis [kg] 1.400; - ABS; für Linkslenker	24.2125-1703.3	010483	Ø 25,4	
			S 16206254→; → 03/02; Nutzlast ab [kg] 1.000 Nutzlast bis [kg] 1.400; + ABS	24.2125-1726.3	010718	Ø 25,4	
1.9 TD	68	03/94→04/02	→ S 15064995; Nutzlast ab [kg] 1.000 Nutzlast bis [kg] 1.400; - ABS; für Linkslenker	24.2122-1715.3	010481	Ø 22,2	
			S 15064996→ S 16206253; Nutzlast ab [kg] 1.000 Nutzlast bis [kg] 1.400; + ABS	24.2125-1702.3	010482	Ø 25,4	
			S 15064996→ S 16205754; Nutzlast ab [kg] 1.000 Nutzlast bis [kg] 1.400; - ABS; für Linkslenker	24.2125-1703.3	010483	Ø 25,4	
			S 16206254→; → 03/02; Nutzlast ab [kg] 1.000 Nutzlast bis [kg] 1.400; + ABS	24.2125-1726.3	010718	Ø 25,4	
2.0 HDI	62	08/01→04/02	→ 03/02; Nutzlast ab [kg] 1.000 Nutzlast bis [kg] 1.800; + ABS	24.2125-1726.3	010718	Ø 25,4	
2.0 i	80	06/94→04/02	→ S 15064995; Nutzlast ab [kg] 1.000 Nutzlast bis [kg] 1.400; - ABS; für Linkslenker	24.2122-1715.3	010481	Ø 22,2	
			S 15064996→ S 16206253; Nutzlast ab [kg] 1.000 Nutzlast bis [kg] 1.400; + ABS	24.2125-1702.3	010482	Ø 25,4	
			→ S 16194399; Nutzlast [kg]: 1.800; + ABS	24.2125-1702.3	010482	Ø 25,4	
			→ S 16205352; Nutzlast [kg]: 1.800; - ABS; für Linkslenker	24.2125-1703.3	010483	Ø 25,4	
			S 15064996→ S 16205754; Nutzlast ab [kg] 1.000 Nutzlast bis [kg] 1.400; - ABS; für Linkslenker	24.2125-1703.3	010483	Ø 25,4	
			S 16206254→; → 03/02; Nutzlast ab [kg] 1.000 Nutzlast bis [kg] 1.400; + ABS	24.2125-1726.3	010718	Ø 25,4	
			S 16194400→; → 03/02; Nutzlast [kg]: 1.800; + ABS	24.2125-1726.3	010718	Ø 25,4	
2.5 D 2.5 D 4x4	63	03/94→04/02	→ S 15064995; Nutzlast [kg]: 1.400; - ABS; für Linkslenker	24.2122-1715.3	010481	Ø 22,2	
	63	07/99→04/02	→ S 16194399; Nutzlast [kg]: 1.800; + ABS	24.2125-1702.3	010482	Ø 25,4	
			S 15064996→ S 16206253; Nutzlast [kg]: 1.400; + ABS	24.2125-1702.3	010482	Ø 25,4	
			→ S 16205352; Nutzlast [kg]: 1.800; - ABS; für Linkslenker	24.2125-1703.3	010483	Ø 25,4	
			S 15064996→ S 16205754; Nutzlast [kg]: 1.400; - ABS; für Linkslenker	24.2125-1703.3	010483	Ø 25,4	
			S 16194400→; → 03/02; Nutzlast [kg]: 1.800; + ABS	24.2125-1726.3	010718	Ø 25,4	
			S 16206254→; → 03/02; Nutzlast [kg]: 1.400; + ABS	24.2125-1726.3	010718	Ø 25,4	
2.5 DT 2.8 D	62	10/97→11/01	→ S 15064995; Nutzlast [kg]: 1.400; - ABS; für Linkslenker	24.2122-1715.3	010481	Ø 22,2	
	64	01/99→02/02	→ S 16194399; Nutzlast [kg]: 1.800; + ABS	24.2125-1702.3	010482	Ø 25,4	
			S 15064996→ S 16206253; Nutzlast [kg]: 1.400; + ABS	24.2125-1702.3	010482	Ø 25,4	
			→ S 16205352; Nutzlast [kg]: 1.800; - ABS; für Linkslenker	24.2125-1703.3	010483	Ø 25,4	
			S 15064996→ S 16205754; Nutzlast [kg]: 1.400; - ABS; für Linkslenker	24.2125-1703.3	010483	Ø 25,4	
			S 16194400→; Nutzlast [kg]: 1.800; + ABS	24.2125-1726.3	010718	Ø 25,4	
			S 16206254→; Nutzlast [kg]: 1.400; + ABS	24.2125-1726.3	010718	Ø 25,4	
2.5 TDI 2.5 TDI 4x4 2.8 HDI	79	01/97→04/02	→ S 16206253; Nutzlast [kg]: 1.400; + ABS	24.2125-1702.3	010482	Ø 25,4	
	79	07/99→04/02	→ S 16194399; Nutzlast [kg]: 1.800; + ABS	24.2125-1702.3	010482	Ø 25,4	
	94	11/00→04/02	→ S 16205352; Nutzlast [kg]: 1.800; - ABS; für Linkslenker	24.2125-1703.3	010483	Ø 25,4	
			→ S 16205754; Nutzlast [kg]: 1.400; - ABS; für Linkslenker	24.2125-1703.3	010483	Ø 25,4	
			S 16194400→; → 03/02; Nutzlast [kg]: 1.800; + ABS	24.2125-1726.3	010718	Ø 25,4	
			S 16206254→; → 03/02; Nutzlast [kg]: 1.400; + ABS	24.2125-1726.3	010718	Ø 25,4	

→

	kw					! #		
PEUGEOT - BOXER Kasten (230L) 03/94→08/06								
 Bremskraftregler								
1.9 D	50-51	03/94→04/02			→ S 16206244; Nutzlast [kg]: 1.000; - ABS		24.6512-1701.3 320153	lastabhängig 2x
1.9 TD	66-68	03/94→04/02			→ S 16206244; Nutzlast ab [kg] 1.000 Nutzlast bis [kg] 1.400; - ABS		24.6512-1701.3 320153	lastabhängig 2x
2.0 HDI 2.0 i	62 80	08/01→04/02 06/94→04/02			→ S 16206244; Nutzlast ab [kg] 1.000 Nutzlast bis [kg] 1.800; - ABS		24.6512-1701.3 320153	lastabhängig 2x
2.5 D 2.5 D 4x4 2.5 DT 2.5 TDI 2.5 TDI 4x4 2.8 D 2.8 HDI	63 63 62 79 79 64 94	03/94→04/02 07/99→04/02 10/97→11/01 01/97→04/02 07/99→04/02 01/99→02/02 11/00→04/02			→ S 16206244; Nutzlast ab [kg] 1.400 Nutzlast bis [kg] 1.800; - ABS		24.6512-1701.3 320153	lastabhängig 2x
2.8 HDi	93	10/00→11/01			11/00→; → S 16206244; Nutzlast ab [kg] 1.400 Nutzlast bis [kg] 1.800; - ABS		24.6512-1701.3 320153	lastabhängig 2x
PEUGEOT - BOXER Kasten (244) 12/01→								
 Hauptbremszylinder								
2.0 2.0 HDi 2.2 HDi 2.8 HDi	81 62 74 93-107	12/01→06/06 04/02→06/06 12/01→06/06 04/04→09/09			→ 03/06; Nutzlast ab [kg] 1.000 Nutzlast bis [kg] 1.800; + ABS		24.2125-1726.3 010718	Ø 25,4
2.0 BiFuel	81	12/01→06/06			04/02→ 03/06; Nutzlast ab [kg] 1.000 Nutzlast bis [kg] 1.800; + ABS		24.2125-1726.3 010718	Ø 25,4
2.3 HDi 2.8 HDi 2.8 HDi 4x4	93 94 94	02/07→ 12/01→06/06 12/01→06/06			Nutzlast ab [kg] 1.000 Nutzlast bis [kg] 1.800; + ABS		24.2125-1726.3 010718	Ø 25,4
 Bremskraftregler								
2.8 HDi 4x4	94	12/01→06/06			Nutzlast ab [kg] 1.000 Nutzlast bis [kg] 1.800; - ABS		24.6512-1701.3 320153	lastabhängig 2x
PEUGEOT - BOXER Pritsche/Fahrgestell 04/06→								
 Hauptbremszylinder								
2.2 HDi 100 2.2 HDi 110 2.2 HDi 120 2.2 HDi 130 2.2 HDi 150 3.0 HDi 145 3.0 HDi 155 3.0 HDi 160 3.0 HDi 175	74 81 88 96 110 107 115 116 130	04/06→ 03/11→ 04/06→ 03/11→ 03/11→ 04/10→12/13 04/06→12/15 04/06→12/15 03/11→			Nutzlast ab [kg] 1.200 Nutzlast bis [kg] 1.400; + DSC; nicht für Facelift; Nutzlast-Code: 12Q / 14Q		24.4125-1701.3 010867	BOS Ø 25,4 ohne Bremsflüssigkeitsbehälter
					Nutzlast ab [kg] 1.200 Nutzlast bis [kg] 1.400; - DSC; nicht für Facelift; Nutzlast-Code: 12Q / 14Q		24.4125-1702.3 010872	BOS Ø 25,4 ohne Bremsflüssigkeitsbehälter
					Nutzlast ab [kg] 1.600 Nutzlast bis [kg] 2.000; + DSC; nicht für Facelift; Nutzlast-Code: 16Q / 20Q		24.4126-1701.3 010868	BOS Ø 27 ohne Bremsflüssigkeitsbehälter
					Nutzlast ab [kg] 1.600 Nutzlast bis [kg] 2.000; - DSC; nicht für Facelift; Nutzlast-Code: 16Q / 20Q		24.4126-1702.3 010875	BOS Ø 27 ohne Bremsflüssigkeitsbehälter
PEUGEOT - BOXER Pritsche/Fahrgestell (244) 12/01→								
 Hauptbremszylinder								
2.0 BiFuel	81	12/01→06/06			04/02→ 03/06; Nutzlast ab [kg] 1.000 Nutzlast bis [kg] 1.800; + ABS		24.2125-1726.3 010718	Ø 25,4
2.0 HDi 2.2 HDi 2.8 HDi 2.8 HDi 4x4	62 74 94-107 94	12/01→06/06 12/01→06/06 12/01→06/06 12/01→06/06			→ 03/06; Nutzlast ab [kg] 1.000 Nutzlast bis [kg] 1.800; + ABS		24.2125-1726.3 010718	Ø 25,4
 Bremskraftregler								
2.8 HDi 4x4	94	12/01→06/06			→ 03/06; Nutzlast ab [kg] 1.000 Nutzlast bis [kg] 1.800; - ABS		24.6512-1701.3 320153	lastabhängig 2x
PEUGEOT - BOXER Pritsche/Fahrgestell (ZCT_) 03/94→04/02								
 Hauptbremszylinder								
1.9 D	51	03/94→04/02			→ S 15064995; für Linkslenker; - ABS; Nutzlast ab [kg] 1.000 Nutzlast bis [kg] 1.400		24.2122-1715.3 010481	Ø 22,2
					S 15064996→ S 16206253; + ABS; Nutzlast ab [kg] 1.000 Nutzlast bis [kg] 1.400		24.2125-1702.3 010482	Ø 25,4
					S 15064996→ S 16205754; für Linkslenker; - ABS; Nutzlast ab [kg] 1.000 Nutzlast bis [kg] 1.400		24.2125-1703.3 010483	Ø 25,4
→								

	kw			 	! #		
PEUGEOT - BOXER Pritsche/Fahrgestell (ZCT_) 03/94 → 04/02							
 Hauptbremszylinder							
1.9 D	51	03/94 → 04/02		S 16206254 →; + ABS; Nutzlast ab [kg] 1.000 Nutzlast bis [kg] 1.400		24.2125-1726.3 010718	Ø 25,4
1.9 TD	66	06/94 → 04/02		12/98 →; → S 16206253; Nutzlast ab [kg] 1.000 Nutzlast bis [kg] 1.400; + ABS		24.2125-1702.3 010482	Ø 25,4
				12/98 →; → S 16205754; Nutzlast ab [kg] 1.000 Nutzlast bis [kg] 1.400; - ABS; für Linkslenker		24.2125-1703.3 010483	Ø 25,4
				S 16206254 →; → 03/02; Nutzlast ab [kg] 1.000 Nutzlast bis [kg] 1.400; + ABS		24.2125-1726.3 010718	Ø 25,4
1.9 TD	68	07/94 → 04/02		07/96 →; → S 16206253; Nutzlast ab [kg] 1.000 Nutzlast bis [kg] 1.400; + ABS		24.2125-1702.3 010482	Ø 25,4
				07/96 →; → S 16205754; Nutzlast ab [kg] 1.000 Nutzlast bis [kg] 1.400; - ABS; für Linkslenker		24.2125-1703.3 010483	Ø 25,4
				S 16206254 →; → 03/02; Nutzlast ab [kg] 1.000 Nutzlast bis [kg] 1.400; + ABS		24.2125-1726.3 010718	Ø 25,4
2.0 2.0 i	81	12/01 → 04/02		→ S 15064995; für Linkslenker; - ABS; Nutzlast ab [kg] 1.000 Nutzlast bis [kg] 1.400		24.2122-1715.3 010481	Ø 22,2
	80	06/94 → 04/02		S 15064996 → S 16206253; + ABS; Nutzlast ab [kg] 1.000 Nutzlast bis [kg] 1.400		24.2125-1702.3 010482	Ø 25,4
				→ S 16194399; Nutzlast [kg]: 1.800; + ABS		24.2125-1702.3 010482	Ø 25,4
				→ S 16205352; Nutzlast [kg]: 1.800; - ABS; für Linkslenker		24.2125-1703.3 010483	Ø 25,4
				S 15064996 → S 16205754; für Linkslenker; - ABS; Nutzlast ab [kg] 1.000 Nutzlast bis [kg] 1.400		24.2125-1703.3 010483	Ø 25,4
				S 16206254 →; → 03/02; Nutzlast ab [kg] 1.000 Nutzlast bis [kg] 1.400; + ABS		24.2125-1726.3 010718	Ø 25,4
				S 16194400 →; → 03/02; Nutzlast [kg]: 1.800; + ABS		24.2125-1726.3 010718	Ø 25,4
				→ S 15064995; Nutzlast [kg]: 1.400; - ABS; für Linkslenker		24.2122-1715.3 010481	Ø 22,2
2.5 D 2.5 D 4x4	63	03/94 → 04/02		→ S 16194399; Nutzlast [kg]: 1.800; + ABS		24.2125-1702.3 010482	Ø 25,4
	63	07/99 → 04/02		S 15064996 → S 16206253; Nutzlast [kg]: 1.400; + ABS		24.2125-1702.3 010482	Ø 25,4
				→ S 16205352; Nutzlast [kg]: 1.800; - ABS; für Linkslenker		24.2125-1703.3 010483	Ø 25,4
				S 15064996 → S 16205754; Nutzlast [kg]: 1.400; - ABS; für Linkslenker		24.2125-1703.3 010483	Ø 25,4
				S 16206254 →; → 03/02; Nutzlast [kg]: 1.400; + ABS		24.2125-1726.3 010718	Ø 25,4
				S 16194400 →; → 03/02; Nutzlast [kg]: 1.800; + ABS		24.2125-1726.3 010718	Ø 25,4
				→ S 16206253; Nutzlast [kg]: 1.400; + ABS		24.2125-1702.3 010482	Ø 25,4
2.5 TDI 2.5 TDI 4x4 2.8 HDI	79	01/97 → 04/02		→ S 16194399; Nutzlast [kg]: 1.800; + ABS		24.2125-1702.3 010482	Ø 25,4
	79	07/99 → 04/02		→ S 16205352; Nutzlast [kg]: 1.800; - ABS; für Linkslenker		24.2125-1703.3 010483	Ø 25,4
				→ S 16205754; Nutzlast [kg]: 1.400; - ABS; für Linkslenker		24.2125-1703.3 010483	Ø 25,4
				S 16206254 →; → 03/02; Nutzlast [kg]: 1.400; + ABS		24.2125-1726.3 010718	Ø 25,4
				S 16194400 →; → 03/02; Nutzlast [kg]: 1.800; + ABS		24.2125-1726.3 010718	Ø 25,4
				→ S 16206253; Nutzlast [kg]: 1.400; + ABS		24.2125-1702.3 010482	Ø 25,4
2.8 D	64	01/99 → 02/02		→ S 16194399; Nutzlast [kg]: 1.800; + ABS		24.2125-1702.3 010482	Ø 25,4
				S 15064995 → S 16206253; Nutzlast [kg]: 1.400; + ABS		24.2125-1702.3 010482	Ø 25,4
				→ S 16205352; Nutzlast [kg]: 1.800; - ABS; für Linkslenker		24.2125-1703.3 010483	Ø 25,4
				S 15064996 → S 16205754; Nutzlast [kg]: 1.400; - ABS; für Linkslenker		24.2125-1703.3 010483	Ø 25,4
				S 16206254 →; Nutzlast [kg]: 1.400; + ABS		24.2125-1726.3 010718	Ø 25,4
				S 16194400 →; Nutzlast [kg]: 1.800; + ABS		24.2125-1726.3 010718	Ø 25,4
				→ S 15064995; Nutzlast [kg]: 1.400; - ABS; für Linkslenker		24.2122-1715.3 010481	Ø 22,2
→							

	kw					! #		
PEUGEOT - BOXER Pritsche/Fahrgestell (ZCT_) 03/94→04/02								
 Bremskraftregler								
1.9 D	51	03/94→04/02			→ S 16206244; Nutzlast ab [kg] 1.000 Nutzlast bis [kg] 1.400; - ABS		24.6512-1701.3 320153	lastabhängig 2x
1.9 TD	66	06/94→04/02			12/98→; → S 16206244; Nutzlast ab [kg] 1.000 Nutzlast bis [kg] 1.400; - ABS		24.6512-1701.3 320153	lastabhängig 2x
1.9 TD	68	07/94→04/02			07/96→; → S 16206244; Nutzlast ab [kg] 1.000 Nutzlast bis [kg] 1.400; - ABS		24.6512-1701.3 320153	lastabhängig 2x
2.0	81	12/01→04/02			→ S 16206244; Nutzlast ab [kg] 1.000 Nutzlast bis [kg] 1.800; - ABS		24.6512-1701.3 320153	lastabhängig 2x
2.0 i	80	06/94→04/02						
2.5 D	63	03/94→04/02			→ S 16206244; Nutzlast ab [kg] 1.400 Nutzlast bis [kg] 1.800; - ABS		24.6512-1701.3 320153	lastabhängig 2x
2.5 D 4x4	63	07/99→04/02						
2.5 TDI	79	01/97→04/02						
2.5 TDI 4x4	79	07/99→04/02						
2.8 D	64	01/99→02/02						
2.8 HDI	94	11/00→04/02						
2.8 HDi	93	10/00→11/01			11/00→; → S 16206244; Nutzlast ab [kg] 1.400 Nutzlast bis [kg] 1.800; - ABS		24.6512-1701.3 320153	lastabhängig 2x
PEUGEOT - EXPERT (224_) 10/95→12/06								
 Hauptbremszylinder								
1.6	58	02/96→09/00			→Orga 08206; - ABS; Nutzlast [kg]: 800		24.2122-1703.3 010422	Ø 22,2
1.8	74	10/96→09/00						
1.9 D	51	12/03→12/06			→Orga 08206; + ABS; Nutzlast [kg]: 800		24.2122-1708.3 010437	Ø 22,2
1.9 TD	66	02/96→09/00			Orga 08207→; - ABS; Nutzlast [kg]: 800		24.2122-1741.3 010695	Ø 22,2
					→Orga 08206; - ABS; Nutzlast [kg]: 900		24.2123-1707.3 010492	Ø 23,8
					Orga 08207→; + ABS; Nutzlast [kg]: 900		24.2123-1733.3 010657	BOS Ø 23,8
					Orga 08207→; - ABS; Nutzlast [kg]: 900		24.2123-1738.3 010658	Ø 23,8
2.0	100	07/00→12/06			+ ABS		24.2123-1733.3 010657	BOS Ø 23,8
2.0 HDi	69	10/00→10/06			- ABS		24.2123-1738.3 010658	Ø 23,8
2.0 HDI	80	07/00→12/06						
2.0 HDI 16V	80	07/00→12/06						
PEUGEOT - EXPERT Kasten (222) 07/95→03/08								
 Hauptbremszylinder								
1.6	58	02/96→09/00			→Orga 08206; - ABS; Nutzlast [kg]: 800		24.2122-1703.3 010422	Ø 22,2
1.8	74	10/96→09/00						
1.9 D 70	51	12/98→12/06			→Orga 08206; + ABS; Nutzlast [kg]: 800		24.2122-1708.3 010437	Ø 22,2
1.9 TD	66	02/96→09/00			Orga 08207→; - ABS; Nutzlast [kg]: 800		24.2122-1741.3 010695	Ø 22,2
					→Orga 08206; - ABS; Nutzlast [kg]: 900		24.2123-1707.3 010492	Ø 23,8
					Orga 08207→; + ABS; Nutzlast [kg]: 900		24.2123-1733.3 010657	BOS Ø 23,8
					Orga 08207→; - ABS; Nutzlast [kg]: 900		24.2123-1738.3 010658	Ø 23,8
2.0	100	09/02→12/06			+ ABS		24.2123-1733.3 010657	BOS Ø 23,8
2.0 HDI	69	07/00→12/06			- ABS		24.2123-1738.3 010658	Ø 23,8
	80							
PEUGEOT - EXPERT Kasten (VF3A_, VF3U_, VF3X_) 01/07→								
 Hauptbremszylinder								
1.6 HDi 90 16V	66	01/07→			für Linkslenker; + ESP		03.2125-0671.3 010965	ATE Ø 25,4
1.6 HDi 90 8V	66	01/07→						
2.0 16V	103	01/07→			für Linkslenker; - ESP		03.2125-0676.3 011009	ATE Ø 25,4 ohne Bremsflüssigkeitsbehälter
2.0 HDi 100	72	03/11→						
2.0 HDi 120	88	01/07→			für Rechtslenker; - ESP		24.2123-3396.3 011035	ATE Ø 23,8 ohne Bremsflüssigkeitsbehälter
2.0 HDi 120 4x4	88	01/10→						
2.0 HDi 130	94	03/11→						
2.0 HDi 130 4x4	94	01/12→03/16						
2.0 HDi 140	100	01/07→						
2.0 HDi 165	120	09/09→						
PEUGEOT - EXPERT Pritsche/Fahrgestell 01/07→								
 Hauptbremszylinder								
1.6 HDi 90 16V	66	01/07→			für Linkslenker; + ESP		03.2125-0671.3 010965	ATE Ø 25,4
1.6 HDi 90 8V	66	01/07→						
2.0 16V	103	01/07→03/16			für Linkslenker; - ESP		03.2125-0676.3 011009	ATE Ø 25,4 ohne Bremsflüssigkeitsbehälter
2.0 HDi 120	88	01/07→						
2.0 HDi 130	94	03/11→			für Rechtslenker; - ESP		24.2123-3396.3 011035	ATE Ø 23,8 ohne Bremsflüssigkeitsbehälter
2.0 HDi 140	100	01/07→						
2.0 HDi 165	120	09/09→						
PEUGEOT - EXPERT Pritsche/Fahrgestell (223) 12/95→12/06								
 Hauptbremszylinder								
1.6	58	02/96→09/00			→Orga 08206; - ABS; Nutzlast [kg]: 800		24.2122-1703.3 010422	Ø 22,2
1.9 D	51	06/98→09/01			→Orga 08206; + ABS; Nutzlast [kg]: 800		24.2122-1708.3 010437	Ø 22,2
1.9 TD	66	02/96→09/00			Orga 08207→; - ABS; Nutzlast [kg]: 800		24.2122-1741.3 010695	Ø 22,2
→								

PEUGEOT - EXPERT Pritsche/Fahrgestell (223) 12/95→12/06

Hauptbremszylinder

1.6 1.9 D 1.9 TD	58	02/96→09/00	→Orga 08206; - ABS; Nutzlast [kg]: 900	24.2123-1707.3 010492	Ø 23,8
	51	06/98→09/01	Orga 08207→; + ABS; Nutzlast [kg]: 900	24.2123-1733.3 010657	BOS Ø 23,8
	66	02/96→09/00	Orga 08207→; - ABS; Nutzlast [kg]: 900	24.2123-1738.3 010658	Ø 23,8
2.0 HDi 2.0 HDI	69 - 80	10/00→10/06	- ABS; Nutzlast [kg]: 800	24.2122-1741.3 010695	Ø 22,2
	80	10/00→10/06	+ ABS; Nutzlast [kg]: 900	24.2123-1733.3 010657	BOS Ø 23,8
	80	10/00→10/06	- ABS; Nutzlast [kg]: 900	24.2123-1738.3 010658	Ø 23,8

PEUGEOT - EXPERT TEPEE (VF3X_) 01/07→













Hauptbremszylinder













1.6 HDi 90 16V	66	01/07→03/16	für Linkslenker; + ESP	03.2125-0671.3 010965	ATE Ø 25,4
1.6 HDi 90 8V	66	01/07→03/16	für Linkslenker; - ESP	03.2125-0676.3 011009	ATE Ø 25,4 ohne Bremsflüssigkeitsbehälter
2.0 16V	103	01/07→03/16			
2.0 HDi 100	72	03/11→03/16			
2.0 HDi 120	88	01/07→03/16	für Rechtslenker; - ESP	24.2123-3396.3 011035	ATE Ø 23,8 ohne Bremsflüssigkeitsbehälter
2.0 HDi 120 4x4	88	01/07→03/16			
2.0 HDi 130	94	03/11→			
2.0 HDi 130 4x4	94	03/11→03/16			
2.0 HDi 140	100	01/07→			
2.0 HDi 165	120	09/09→			















PEUGEOT - PARTNER Großraumlimousine (5_, G_) 05/96→













Hauptbremszylinder











1.1 1.9 D	44	06/96→10/02	Orga 08610→; - ABS	03.2123-2781.3 010631	ATE Ø 23,8
	50	06/96→12/02		24.2123-1714.3 010587	BDX Ø 23,8
			07/96→; →Orga 08609; - ABS	24.2123-1710.3 010504	Ø 23,8
			07/96→; →Orga 08609; + ABS; für Linkslenker	24.2123-1713.3 010505	Ø 23,8
1.4	55	06/96→12/15	Orga 08610→; → 03/08; - ABS	03.2123-2781.3 010631	ATE Ø 23,8
				24.2123-1714.3 010587	BDX Ø 23,8
			07/96→; →Orga 08609; - ABS	24.2123-1710.3 010504	Ø 23,8
			07/96→; →Orga 08609; + ABS; für Linkslenker	24.2123-1713.3 010505	Ø 23,8
1.6 16V 1.6 Flexfuel 2.0 HDi 4x4	80 80 66	07/01→03/08 09/00→10/02 04/04→08/05	Orga 08610→; → 03/08; + ABS	24.2123-1715.3 010520	BDX Ø 23,8
			- ESP / - ABS	03.2123-2781.3 010631	ATE Ø 23,8
				24.2123-1714.3 010587	BDX Ø 23,8
			- ESP / + ABS	24.2123-1715.3 010520	BDX Ø 23,8
1.6 HDi 75	55	08/05→07/08	→ 03/08; - ABS	03.2123-2781.3 010631	ATE Ø 23,8
				24.2123-1714.3 010587	BDX Ø 23,8
			→ 03/08; + ABS	24.2123-1715.3 010520	BDX Ø 23,8
1.6 HDi 90	66	08/05→12/15	02/06→ 03/08; - ABS	03.2123-2781.3 010631	ATE Ø 23,8
				24.2123-1714.3 010587	BDX Ø 23,8
			02/06→ 03/08; + ABS	24.2123-1715.3 010520	BDX Ø 23,8
1.6 HDI 92	68	11/09→12/10	- ABS	24.2123-1714.3 010587	BDX Ø 23,8
			+ ABS / - ESP	24.2123-1715.3 010520	BDX Ø 23,8
1.8	66	05/97→12/02	Orga 08610→; - ABS	03.2123-2781.3 010631	ATE Ø 23,8
				24.2123-1714.3 010587	BDX Ø 23,8
			→Orga 08609; - ABS	24.2123-1710.3 010504	Ø 23,8
			→Orga 08609; + ABS; für Linkslenker	24.2123-1713.3 010505	Ø 23,8
1.9 D	51	01/99→07/08	Orga 08610→; + ABS	24.2123-1715.3 010520	BDX Ø 23,8
			Orga 08610→; → 03/08; - ABS	03.2123-2781.3 010631	ATE Ø 23,8
				24.2123-1714.3 010587	BDX Ø 23,8
			→Orga 08609; - ABS	24.2123-1710.3 010504	Ø 23,8
2.0 HDI	66	02/00→07/08	→Orga 08609; + ABS; für Linkslenker	24.2123-1713.3 010505	Ø 23,8
			Orga 08610→; → 03/08; + ABS	24.2123-1715.3 010520	BDX Ø 23,8
			→ 03/08; - ESP / - ABS	03.2123-2781.3 010631	ATE Ø 23,8
				24.2123-1714.3 010587	BDX Ø 23,8
Electric	28	01/98→12/01	→ 03/08; - ESP / + ABS	24.2123-1715.3 010520	BDX Ø 23,8
			Orga 08610→; - ABS	03.2123-2781.3 010631	ATE Ø 23,8
				24.2123-1714.3 010587	BDX Ø 23,8
			→Orga 08609; - ABS	24.2123-1710.3 010504	Ø 23,8
Electric	28	01/98→12/01	→Orga 08609; für Linkslenker; - ABS	24.2123-1713.3 010505	Ø 23,8
			Orga 08610→; + ABS	24.2123-1715.3 010520	BDX Ø 23,8

	kw					! #		
PEUGEOT - PARTNER Kasten/Großraumlimousine 04/08→								
 Hauptbremszylinder								
1.2 THP 1.6	81 66 - 88	02/16→ 04/08→		+ ESP; →Orga 14685			24.4123-1714.3 010979	TRW Ø 23,8
1.6 BlueHDi 100	73	04/15→						
1.6 BlueHDi 100 4x4	73	04/15→						
1.6 BlueHDi 120	88	04/15→						
1.6 HDi	55 - 84	04/08→						
1.6 HDi 16V	66 - 68	04/08→						
1.6 HDi 16V 4x4	66	04/12→						
1.6 HDi 4x4	84	07/12→						
1.6 HDi 90	68	04/10→						
1.6 HDi / BlueHDi 75	55	07/11→		01/15→; + ESP; →Orga 14685			24.4123-1714.3 010979	TRW Ø 23,8
PEUGEOT - PARTNER Kasten/Großraumlimousine (5_, G_) 06/96→								
 Hauptbremszylinder								
1.1	44	06/96→09/05		Orga 08610→; - ABS			03.2123-2781.3 010631	ATE Ø 23,8
1.8 D	43	06/96→12/02					24.2123-1714.3 010587	BDX Ø 23,8
1.9 D	51	06/96→12/02		07/96→; →Orga 08609; - ABS			24.2123-1710.3 010504	Ø 23,8
				07/96→; →Orga 08609; + ABS; für Linkslenker			24.2123-1713.3 010505	Ø 23,8
				Orga 08610→; + ABS			24.2123-1715.3 010520	BDX Ø 23,8
1.4	48 - 54	11/02→12/10		Orga 08610→; - ABS			03.2123-2781.3 010631	ATE Ø 23,8
1.4 CNG	55	04/03→10/06					24.2123-1714.3 010587	BDX Ø 23,8
1.8	66	03/97→08/00		→Orga 08609; - ABS			24.2123-1710.3 010504	Ø 23,8
1.9 D 4x4	51	04/04→07/11		→Orga 08609; + ABS; für Linkslenker			24.2123-1713.3 010505	Ø 23,8
				Orga 08610→; + ABS			24.2123-1715.3 010520	BDX Ø 23,8
1.4	55	06/96→12/15		Orga 08610→; → 03/08; - ABS			03.2123-2781.3 010631	ATE Ø 23,8
1.9 D	51	06/96→12/15					24.2123-1714.3 010587	BDX Ø 23,8
				07/96→; →Orga 08609; - ABS			24.2123-1710.3 010504	Ø 23,8
				07/96→; →Orga 08609; + ABS; für Linkslenker			24.2123-1713.3 010505	Ø 23,8
				Orga 08610→; → 03/08; + ABS			24.2123-1715.3 010520	BDX Ø 23,8
1.6 HDi 75	55	08/05→07/08		- ABS			03.2123-2781.3 010631	ATE Ø 23,8
2.0 HDi 4x4	66	04/04→08/05					24.2123-1714.3 010587	BDX Ø 23,8
				+ ABS			24.2123-1715.3 010520	BDX Ø 23,8
1.6 HDi 90	66	08/05→12/15		→ 03/08; - ABS			03.2123-2781.3 010631	ATE Ø 23,8
2.0 HDi	66	04/00→07/08					24.2123-1714.3 010587	BDX Ø 23,8
				→ 03/08; + ABS			24.2123-1715.3 010520	BDX Ø 23,8
1.6 HDi 92	68	11/09→12/10		- ABS			24.2123-1714.3 010587	BDX Ø 23,8
				+ ABS / - ESP			24.2123-1715.3 010520	BDX Ø 23,8
Electric	25	06/96→12/02		01/98→; - ABS			03.2123-2781.3 010631	ATE Ø 23,8
							24.2123-1714.3 010587	BDX Ø 23,8
				01/98→; + ABS			24.2123-1715.3 010520	BDX Ø 23,8
PEUGEOT - PARTNER ORIGIN Großraumlimousine (G_) 07/08→12/13								
 Hauptbremszylinder								
1.4	55	07/08→12/13		- ABS			24.2123-1714.3 010587	BDX Ø 23,8
1.6 16V	81	09/11→12/13						
1.6 HDi 75	55	08/08→12/13		+ ABS			24.2123-1715.3 010520	BDX Ø 23,8
1.9 D	51	08/08→12/13						
PEUGEOT - PARTNER ORIGIN Kasten/Großraumlimousine (G_) 07/08→12/15								
 Hauptbremszylinder								
1.4	55	08/08→12/15		- ABS			24.2123-1714.3 010587	BDX Ø 23,8
1.6	81	09/11→12/15						
1.6 HDi 75	55	08/08→12/15		+ ABS			24.2123-1715.3 010520	BDX Ø 23,8
1.6 HDi 90	66	08/08→12/15						
1.9 D	51	08/08→12/15						
Electric	42	01/11→12/12						
PEUGEOT - PARTNER Pritsche/Fahrgestell 01/09→								
 Hauptbremszylinder								
1.6 BlueHDi 100	73	04/15→		+ ESP; →Orga 14685			24.4123-1714.3 010979	TRW Ø 23,8
1.6 HDi	55 - 66	01/09→						
1.6 HDi 16V	66	01/09→						











	kW					! #		
PEUGEOT - PARTNER Pritsche/Fahrgestell (5_, G_) 03/97→07/08								
 Hauptbremszylinder								
1.6 HDi 75	55	02/06→07/08		- ABS		03.2123-2781.3 010631	ATE Ø 23,8	
				+ ABS		24.2123-1714.3 010587	BDX Ø 23,8	
1.8	66	03/97→08/00		Orga 08610→; - ABS		03.2123-2781.3 010631	ATE Ø 23,8	
				→Orga 08609; - ABS		24.2123-1714.3 010587	BDX Ø 23,8	
				→Orga 08609; - ABS		24.2123-1710.3 010504	Ø 23,8	
				→Orga 08609; + ABS; für Linkslenker		24.2123-1713.3 010505	Ø 23,8	
				Orga 08610→; + ABS		24.2123-1715.3 010520	BDX Ø 23,8	
1.9 D	51	01/99→07/08		Orga 08610→; → 03/08; - ABS		03.2123-2781.3 010631	ATE Ø 23,8	
				→Orga 08609; - ABS		24.2123-1714.3 010587	BDX Ø 23,8	
				→Orga 08609; - ABS		24.2123-1710.3 010504	Ø 23,8	
				→Orga 08609; + ABS; für Linkslenker		24.2123-1713.3 010505	Ø 23,8	
				Orga 08610→; → 03/08; + ABS		24.2123-1715.3 010520	BDX Ø 23,8	
2.0 HDi	66	11/02→07/08		→ 03/08; - ABS		03.2123-2781.3 010631	ATE Ø 23,8	
				→ 03/08; - ABS		24.2123-1714.3 010587	BDX Ø 23,8	
				→ 03/08; + ABS		24.2123-1715.3 010520	BDX Ø 23,8	
PEUGEOT - PARTNER TEPEE 04/08→								
 Hauptbremszylinder								
1.2 THP	81	02/16→		+ ESP; →Orga 14685		24.4123-1714.3 010979	TRW Ø 23,8	
1.6 BlueHDi 100	73	12/14→						
1.6 BlueHDi 100 4x4	73	04/15→						
1.6 BlueHDi 120	88	12/14→						
1.6 HDi	66 -	04/08→						
	84							
1.6 HDi / BlueHDi 75	55	06/08→12/18						
1.6 HDi 16V	66	04/08→						
1.6 HDi 75	55	06/08→						
1.6 HDi 90	68	04/10→						
1.6 VTi	66 -	04/08→						
	88							
1.6 VTi	81	09/08→		04/10→; + ESP; →Orga 14685		24.4123-1714.3 010979	TRW Ø 23,8	
PORSCHE - 911 (996) 08/97→09/05								
 Hauptbremszylinder								
3.4 Carrera	221 -	08/97→07/01				24.2123-1717.3 010521	Ø 23,8	
	235							
3.6 Carrera	235	10/01→08/04						
3.6 Carrera S	254	02/03→08/05						
3.6 S	331	08/04→08/05						
3.4 Carrera 4	221 -	08/97→07/01				24.2123-1730.3 010620	Ø 23,8	
	235							
3.6 Carrera 4	235	10/01→08/04						
3.6 Carrera 4S	254	02/03→07/04						
PORSCHE - 911 (997) 07/04→12/13								
 Hauptbremszylinder								
3.6 Carrera	235 -	07/04→12/08				24.2123-1766.3 010825	TRW Ø 23,8	
	239							
PORSCHE - 911 Cabriolet (996) 08/97→08/05								
 Hauptbremszylinder								
3.4 Carrera	221 -	08/97→09/01				24.2123-1717.3 010521	Ø 23,8	
	235							
3.6 Carrera	235	10/01→08/05						
3.6 Carrera S	254	06/02→08/05						
3.4 Carrera 4	221 -	08/97→09/01				24.2123-1730.3 010620	Ø 23,8	
	235							
3.6 Carrera 4	235	10/01→08/05						
3.6 Carrera 4S	254	06/02→08/05						
PORSCHE - 911 Cabriolet (997) 04/05→12/13								
 Hauptbremszylinder								
3.6 Carrera	235 -	04/05→12/11				24.2123-1766.3 010825	TRW Ø 23,8	
	254							
3.6 Carrera 4	239 -	04/05→12/12						
	254							













	kw					! #		
PORSCHE - 911 Targa (996) 12/01→08/05								
 Hauptbremszylinder								
3.6	235	12/01→08/05					24.2123-1717.3 010521	Ø 23,8
PORSCHE - BOXSTER (986) 09/96→12/04								
 Hauptbremszylinder								
2.5	150	09/96→08/99		→ 07/99			24.2123-1717.3 010521	Ø 23,8
2.7	155	06/99→12/02		08/99→ 12/00			24.2123-1717.3 010521	Ø 23,8
				12/01→ 06/02			24.2123-1730.3 010620	Ø 23,8
2.7	162	08/99→07/02		→ 12/00			24.2123-1717.3 010521	Ø 23,8
S 3.2	185	08/99→07/02		12/01→ 06/02			24.2123-1730.3 010620	Ø 23,8
2.7	168	07/02→12/04					24.2123-1730.3 010620	Ø 23,8
S 3.2	191 - 196	07/02→12/04						
PORSCHE - BOXSTER (987) 06/04→12/13								
 Hauptbremszylinder								
2.7	176	11/04→12/06		→ 07/06; für Fahrzeuge ohne Keramik-			24.2123-1766.3 010825	TRW Ø 23,8
S 3.2	206	11/04→12/06		bremse				
2.7	180	07/06→12/09		für Fahrzeuge ohne Keramikbremse			24.2123-1766.3 010825	TRW Ø 23,8
S 3.4	217	07/06→12/09						
2.9	155 - 188	02/09→03/12		→ 09/11; für Fahrzeuge ohne Keramik-			24.2123-1766.3 010825	TRW Ø 23,8
S 3.4	228 - 235	06/09→05/12		bremse				
S 3.4	223	08/08→12/09		06/09→; für Fahrzeuge ohne Keramik-			24.2123-1766.3 010825	TRW Ø 23,8
				bremse				
PORSCHE - BOXSTER Spyder (987) 09/07→12/11								
 Hauptbremszylinder								
3.4 RS 60	223	09/07→12/08		08/08→; für Fahrzeuge ohne Keramik-			24.2123-1766.3 010825	TRW Ø 23,8
				bremse				
PORSCHE - CAYENNE (9PA) 09/02→12/10								
 Bremskraftverstärker								
3.0 TDI	176	02/09→09/10		→ 04/10; für Linkslenker			03.7868-4102.4 300250	ATE Ø 10 / 8" pneumatisch
3.6	213	02/07→09/10						
S 4.8	283	02/07→09/10						
Pedalwegsensor, Bremspedal								
3.2	177	08/03→09/07		10/03→ 12/06			03.0655-0006.2 370006	ATE
3.2	184	10/03→09/07		→ 12/06			03.0655-0006.2 370006	ATE
S 4.5	250	09/02→09/07						
Turbo 4.5	331	09/02→09/07						
 Hauptbremszylinder								
3.0 TDI	176	02/09→09/10		→ 04/10; für Linkslenker			03.2126-3014.3 010811	ATE Ø 27
3.6	213	02/07→09/10		→ 04/10; für Rechtslenker			24.2126-3032.3 011036	ATE Ø 27 ohne Bremsflüssig-
GTS 4.8	298	10/07→09/10						keitsbehälter
S 4.8	283	02/07→09/10						
Turbo S 4.8	368 - 404	02/07→09/10						
3.2	177	08/03→09/07		10/03→ 12/06; für Linkslenker			03.2126-3014.3 010811	ATE Ø 27
				10/03→; für Rechtslenker; → 12/06			24.2126-3032.3 011036	ATE Ø 27 ohne Bremsflüssig-
								keitsbehälter
3.2	184	10/03→09/07		→ 12/06; für Linkslenker			03.2126-3014.3 010811	ATE Ø 27
S 4.5	250	09/02→09/07		für Rechtslenker; → 12/06			24.2126-3032.3 011036	ATE Ø 27 ohne Bremsflüssig-
Turbo 4.5	331	09/02→09/07						keitsbehälter
Turbo 4.8	373	09/07→12/09		für Linkslenker			03.2126-3014.3 010811	ATE Ø 27
Turbo S 4.5	368 - 383	01/04→09/07		für Rechtslenker			24.2126-3032.3 011036	ATE Ø 27 ohne Bremsflüssig-
								keitsbehälter
PORSCHE - CAYMAN (987) 11/05→12/13								
 Hauptbremszylinder								
2.7	180	07/06→12/09		für Fahrzeuge ohne Keramikbremse			24.2123-1766.3 010825	TRW Ø 23,8
S 3.4	217	11/05→12/09						
2.9	155 - 195	02/09→06/13		→ 05/12; für Fahrzeuge ohne Keramik-			24.2123-1766.3 010825	TRW Ø 23,8
R 3.4	243	11/10→12/12		bremse				
S 3	223	08/08→12/12						
4 Sport	223	08/08→12/12						
S 3.4	235	02/09→06/13						

	kw					! #		
RENAULT - 19 II Cabriolet (D53_, 853_) 04/92→06/01								
 Hauptbremszylinder								
1.8	86	01/95→06/01		→ 03/95; - ABS		03.2120-2031.3	010106	ATE Ø 20,6
				→ 03/95; + ABS		24.2120-1725.3	010579	BDX Ø 20,6
RENAULT - AVANTIME (DE0_) 09/01→05/03								
 Hauptbremszylinder								
2.0 16V Turbo	120	11/01→05/03				03.2123-1486.3	010488	Ø 23,8
2.2 dCi	110	05/02→05/03		- ASR		03.2123-1486.3	010488	Ø 23,8
3.0 V6	152	09/01→05/03		+ ASR		03.2123-2621.3	010701	ATE Ø 23,8
RENAULT - CAPTUR I (J5_, H5_) 06/13→								
 Hauptbremszylinder								
0.9 TCe 90	66	06/13→		für Linkslenker		24.4123-1723.3	011074	Ø 23,8 ohne Bremsflüssigkeitsbehälter
1.2 T	83 - 85	06/13→						
1.2 TCe	97	02/18→		für Rechtslenker		24.4123-1724.3	011075	TRW Ø 23,8 ohne Bremsflüssigkeitsbehälter
1.2 TCe 120	87 - 88	06/13→						
1.3 TCe 130	96	03/18→						
1.3 TCe 150	110	03/18→						
1.5 dCi	63	06/13→						
1.5 dCi 110	81	01/15→						
1.5 dCi 90	66	06/13→						
1.6	84	02/18→						
RENAULT - CLIO II (BB_, CB_) 03/98→12/16								
 Bremskraftverstärker								
1.0	40	02/00→05/01		für Linkslenker; - ABS		03.7750-1332.4	300155	ATE Ø 9" pneumatisch
1.2	43	09/98→02/10						
1.2 LPG	43 - 44	09/98→06/09						
1.4	55	09/98→05/05						
1.5 dCi	47	06/05→12/10						
1.6	66 - 81	09/98→02/09						
1.6 16V	79	09/98→04/05						
1.6 Flex	81	05/00→12/06						
1.9 D	47 - 48	09/98→05/05						
1.2 16V	55	06/01→08/16		→ 10/03; für Linkslenker; - ABS		03.7750-1332.4	300155	
				→ 10/03; + ESP		03.7853-0702.4	300195	
1.4 16V	70	10/99→09/04		→ 07/00; für Linkslenker; - ABS		03.7750-1332.4	300155	
				→ 07/00; + ESP		03.7853-0702.4	300195	
1.4 16V	72	02/00→07/08		für Linkslenker; - ABS		03.7750-1332.4	300155	
1.5 dCi	42 - 74	06/01→12/12		+ ESP		03.7853-0702.4	300195	
1.9 dTi	59	12/99→05/05		02/00→; für Linkslenker; - ABS		03.7750-1332.4	300155	
 Hauptbremszylinder								
1.0	40	02/00→05/01		für Linkslenker; - ABS		03.2120-4381.3	010526	ATE Ø 20,6
1.2	43	09/98→02/10		für Linkslenker; + ABS		03.2120-4461.3	010571	ATE Ø 20,6
1.2 LPG	43 - 44	09/98→06/09		für Linkslenker; + ESP		03.2120-4468.3	010789	ATE Ø 20,6
1.4	55	09/98→05/05						
1.4 16V	72	02/00→07/08						
1.5 dCi	42 - 74	06/01→12/12						
1.6	66 - 81	09/98→02/09						
1.6 16V	79	09/98→04/05						
1.6 Flex	81	05/00→12/06						
1.9 D	47 - 48	09/98→05/05						
1.2 16V	55	06/01→08/16		→ 10/03; für Linkslenker; - ABS		03.2120-4381.3	010526	ATE Ø 20,6
				→ 10/03; für Linkslenker; + ABS		03.2120-4461.3	010571	ATE Ø 20,6
				→ 10/03; für Linkslenker; + ESP		03.2120-4468.3	010789	ATE Ø 20,6
1.4 16V	70	10/99→09/04		→ 07/00; für Linkslenker; - ABS		03.2120-4381.3	010526	ATE Ø 20,6
				→ 07/00; für Linkslenker; + ABS		03.2120-4461.3	010571	ATE Ø 20,6
				→ 07/00; für Linkslenker; + ESP		03.2120-4468.3	010789	ATE Ø 20,6
1.9 dTi	59	12/99→05/05		02/00→; für Linkslenker; - ABS		03.2120-4381.3	010526	ATE Ø 20,6
				02/00→; für Linkslenker; + ABS		03.2120-4461.3	010571	ATE Ø 20,6
				02/00→; für Linkslenker; + ESP		03.2120-4468.3	010789	ATE Ø 20,6
2.0 16V Sport	124 - 132	02/00→06/09		für Linkslenker		03.2122-1926.3	010916	ATE Ø 22,2













	kw				! #		
RENAULT - CLIO II Kasten/Schrägheck (SB0/1/2_) 09/98→							
 Bremskraftverstärker							
1.2 1.9 D	44 40 - 48	03/99→10/03 03/99→05/01		- ABS		03.7750-1332.4 300155	ATE Ø 9" pneumatisch
1.9 DTi	59	02/00→05/01					
1.5 dCi	48 - 60	06/01→		für Linkslenker; → 12/12; - ABS		03.7750-1332.4 300155	ATE Ø 9" pneumatisch
				→ 12/12; + ESP		03.7853-0702.4 300195	ATE Ø 9" pneumatisch
1.5 dCi	59	06/01→10/04		für Linkslenker; - ABS		03.7750-1332.4 300155	ATE Ø 9" pneumatisch
				+ ESP		03.7853-0702.4 300195	ATE Ø 9" pneumatisch
1.5 dCi	47	06/05→12/10		für Linkslenker; - ABS		03.7750-1332.4 300155	ATE Ø 9" pneumatisch
1.6	79	11/03→		→ 04/05; + ESP		03.7853-0702.4 300195	ATE Ø 9" pneumatisch
 Hauptbremszylinder							
1.2 1.9 D	44 40 - 48	03/99→10/03 03/99→05/01		- ABS		03.2120-4381.3 010526	ATE Ø 20,6
1.9 DTi	59	02/00→05/01		- ESP		03.2120-4461.3 010571	ATE Ø 20,6
				+ ESP		03.2120-4468.3 010789	ATE Ø 20,6
1.5 dCi	48 - 60	06/01→		für Linkslenker; → 12/12; - ABS		03.2120-4381.3 010526	ATE Ø 20,6
				für Linkslenker; → 12/12; - ESP		03.2120-4461.3 010571	ATE Ø 20,6
				für Linkslenker; → 12/12; + ESP		03.2120-4468.3 010789	ATE Ø 20,6
1.5 dCi	59	06/01→10/04		für Linkslenker; - ABS		03.2120-4381.3 010526	ATE Ø 20,6
				für Linkslenker; - ESP		03.2120-4461.3 010571	ATE Ø 20,6
				für Linkslenker; + ESP		03.2120-4468.3 010789	ATE Ø 20,6
1.5 dCi	47	06/05→12/10		für Linkslenker; - ABS		03.2120-4381.3 010526	ATE Ø 20,6
				für Linkslenker; + ABS		03.2120-4461.3 010571	ATE Ø 20,6
				für Linkslenker; + ESP		03.2120-4468.3 010789	ATE Ø 20,6
1.6	79	11/03→		→ 04/05; - ABS		03.2120-4381.3 010526	ATE Ø 20,6
				→ 04/05; - ESP		03.2120-4461.3 010571	ATE Ø 20,6
				→ 04/05; + ESP		03.2120-4468.3 010789	ATE Ø 20,6
RENAULT - CLIO III (BR0/1, CR0/1) 01/05→12/14							
 Bremskraftverstärker							
1.2 1.2 16V	57 43 - 48	10/05→12/12 06/05→12/14		12/07→; für Linkslenker; + ABS		03.7863-1232.4 300314	ATE Ø 10" pneumatisch
1.4 16V	72	06/05→12/12		→ 11/07; für Linkslenker; + ABS		03.7863-4502.4 300230	ATE Ø 10" pneumatisch
1.5 dCi	50 - 76	06/05→12/12					
1.6	79	09/05→12/10					
1.2 16V	55 - 74	06/05→12/14		12/07→; für Linkslenker; → 12/12; + ABS		03.7863-1232.4 300314	ATE Ø 10" pneumatisch
1.5 dCi	78	06/05→12/14		→ 11/07; für Linkslenker; + ABS		03.7863-4502.4 300230	ATE Ø 10" pneumatisch
1.6 16V	82	06/05→12/14					
2.0 16V	102	09/06→12/14					
1.2 16V	76	09/10→12/14		→ 12/12; für Linkslenker; + ABS		03.7863-1232.4 300314	ATE Ø 10" pneumatisch
1.5 dCi	55 - 65	08/10→12/14					
1.6 16V GT	94	06/09→12/14					
1.2 16V Hi-Flex	55	07/08→12/14		für Linkslenker; + ABS		03.7863-1232.4 300314	ATE Ø 10" pneumatisch
1.2 Ethanol	55	07/08→12/12					
1.5 dCi	48	05/05→07/10		→ 10/06; für Linkslenker; + ABS		03.7863-4502.4 300230	ATE Ø 10" pneumatisch
1.5 dCi	60	11/07→12/12		12/07→; für Linkslenker; + ABS		03.7863-1232.4 300314	ATE Ø 10" pneumatisch
1.6 16V	65	06/05→10/07		für Linkslenker; + ABS		03.7863-4502.4 300230	ATE Ø 10" pneumatisch
2.0 16V Sport	148	09/08→12/14		für Linkslenker; → 12/12		03.7860-3702.4 300305	ATE Ø 9" pneumatisch
2.0 16V Sport	145	02/06→12/12		für Linkslenker		03.7860-3702.4 300305	ATE Ø 9" pneumatisch
 Hauptbremszylinder							
1.2 1.2 16V	57 43 - 58	10/05→12/12 06/05→12/14		- ABS		03.2123-2821.3 010944	ATE Ø 23,8
1.4 16V	72	06/05→12/12		12/07→; für Linkslenker; - ESP		03.2123-2863.3 010790	ATE Ø 23,8
1.5 dCi	50 - 76	06/05→12/12		12/07→; für Linkslenker; + ESP		03.2123-2923.3 010791	ATE Ø 23,8
				→ 11/07; für Linkslenker; - ESP		03.2123-3241.3 010882	ATE Ø 23,8
1.6	79	09/05→12/10		→ 11/07; für Linkslenker; + ESP		03.2123-3493.3 010792	ATE Ø 23,8
1.2 16V	76	09/10→12/14		→ 12/12; - ABS		03.2123-2821.3 010944	ATE Ø 23,8
1.5 dCi	55 - 65	08/10→12/14		für Linkslenker; → 12/12; - ESP		03.2123-2863.3 010790	ATE Ø 23,8
1.6 16V GT	94	06/09→12/14		für Linkslenker; → 12/12; + ESP		03.2123-2923.3 010791	ATE Ø 23,8
1.2 16V	55 - 74	06/05→12/14		→ 12/12; - ABS		03.2123-2821.3 010944	ATE Ø 23,8
1.5 dCi	78	06/05→12/14		12/07→; für Linkslenker; → 12/12; - ESP		03.2123-2863.3 010790	ATE Ø 23,8
1.6 16V	82	06/05→12/14		12/07→; für Linkslenker; → 12/12; + ESP		03.2123-2923.3 010791	ATE Ø 23,8
→							





























	kw				! #		
RENAULT - CLIO III (BR0/1, CR0/1) 01/05→12/14							
 Hauptbremszylinder							
2.0 16V	102	09/06→12/14		→ 11/07; für Linkslenker; - ESP		03.2123-3241.3 010882	ATE Ø 23,8
				→ 11/07; für Linkslenker; + ESP		03.2123-3493.3 010792	ATE Ø 23,8
1.2 16V Hi-Flex 1.2 Ethanol	55 55	07/08→12/14 07/08→12/12		- ABS		03.2123-2821.3 010944	ATE Ø 23,8
				für Linkslenker; - ESP		03.2123-2863.3 010790	ATE Ø 23,8
				für Linkslenker; + ESP		03.2123-2923.3 010791	ATE Ø 23,8
1.5 dCi	48	05/05→07/10		→ 10/06; - ABS		03.2123-2821.3 010944	ATE Ø 23,8
				→ 10/06; für Linkslenker; - ESP		03.2123-3241.3 010882	ATE Ø 23,8
				→ 10/06; für Linkslenker; + ESP		03.2123-3493.3 010792	ATE Ø 23,8
1.5 dCi	60	11/07→12/12		- ABS		03.2123-2821.3 010944	ATE Ø 23,8
				12/07→; für Linkslenker; - ESP		03.2123-2863.3 010790	ATE Ø 23,8
				12/07→; für Linkslenker; + ESP		03.2123-2923.3 010791	ATE Ø 23,8
1.6 16V	65	06/05→10/07		- ABS		03.2123-2821.3 010944	ATE Ø 23,8
				für Linkslenker; - ESP		03.2123-3241.3 010882	ATE Ø 23,8
				für Linkslenker; + ESP		03.2123-3493.3 010792	ATE Ø 23,8
2.0 16V Sport	148	09/08→12/14		→ 12/12; - ABS		03.2123-2821.3 010944	ATE Ø 23,8
				für Linkslenker; → 12/12		03.2123-3493.3 010792	ATE Ø 23,8
2.0 16V Sport	145	02/06→12/12		- ABS		03.2123-2821.3 010944	ATE Ø 23,8
				für Linkslenker		03.2123-3493.3 010792	ATE Ø 23,8
RENAULT - CLIO III Grandtour (KR0/1_) 11/07→							
 Bremskraftverstärker							
1.2 16V	55 - 76	11/07→12/14		für Linkslenker		03.7863-4502.4 300230	ATE Ø 10" pneumatisch
1.2 16V Hi-Flex	55 - 58	11/07→12/14					
1.4 16V	72	11/07→12/12					
1.5 dCi	48 - 78	11/07→12/12					
1.6 16V	80 - 94	11/07→12/12					
 Hauptbremszylinder							
1.2 16V	55 - 76	11/07→12/14		- ABS		03.2123-2821.3 010944	ATE Ø 23,8
1.2 16V Hi-Flex	55 - 58	11/07→12/14		- ESP		03.2123-3241.3 010882	ATE Ø 23,8
				+ ESP		03.2123-3493.3 010792	ATE Ø 23,8
1.5 dCi	48 - 78	11/07→12/12					
1.6 16V	80 - 82	11/07→12/12					
1.4 16V	72	11/07→12/12		- ESP		03.2123-3241.3 010882	ATE Ø 23,8
				+ ESP		03.2123-3493.3 010792	ATE Ø 23,8
1.6 16V	94	11/07→12/12		- ESP		03.2123-2863.3 010790	ATE Ø 23,8
				+ ESP		03.2123-2923.3 010791	ATE Ø 23,8
RENAULT - CLIO III Kasten/Schrägheck (SB_, SR_) 06/05→							
 Bremskraftverstärker							
1.2	55	11/05→12/14		12/07→; für Linkslenker; → 12/12; + ABS		03.7863-1232.4 300314	ATE Ø 10" pneumatisch
				→ 11/07; für Linkslenker; + ABS		03.7863-4502.4 300230	ATE Ø 10" pneumatisch
1.2	74	11/07→12/11		12/07→; für Linkslenker; + ABS		03.7863-1232.4 300314	ATE Ø 10" pneumatisch
1.5 dCi	50 - 63	06/05→07/10		→ 11/07; für Linkslenker; + ABS		03.7863-4502.4 300230	ATE Ø 10" pneumatisch
1.2 Hi-Flex	58	11/07→12/09		für Linkslenker		03.7863-4502.4 300230	ATE Ø 10" pneumatisch
1.5 dCi	55	08/10→12/14		für Linkslenker; + ABS		03.7863-1232.4 300314	ATE Ø 10" pneumatisch
1.5 dCi	78	10/05→10/07		für Linkslenker; + ABS		03.7863-4502.4 300230	ATE Ø 10" pneumatisch
1.5 dCi	65	08/10→12/14		→ 12/12; für Linkslenker; + ABS		03.7863-1232.4 300314	ATE Ø 10" pneumatisch
 Hauptbremszylinder							
1.2	55	11/05→12/14		→ 12/12; - ABS		03.2123-2821.3 010944	ATE Ø 23,8
				12/07→; für Linkslenker; → 12/12; - ESP		03.2123-2863.3 010790	ATE Ø 23,8
				12/07→; für Linkslenker; → 12/12; + ESP		03.2123-2923.3 010791	ATE Ø 23,8
				→ 11/07; für Linkslenker; - ESP		03.2123-3241.3 010882	ATE Ø 23,8
				→ 11/07; für Linkslenker; + ESP		03.2123-3493.3 010792	ATE Ø 23,8
1.2	74	11/07→12/11		- ABS		03.2123-2821.3 010944	ATE Ø 23,8
1.5 dCi	50 - 63	06/05→07/10		12/07→; für Linkslenker; - ESP		03.2123-2863.3 010790	ATE Ø 23,8
				12/07→; für Linkslenker; + ESP		03.2123-2923.3 010791	ATE Ø 23,8
→							











	kw					! #		
RENAULT - CLIO III Kasten/Schrägheck (SB_, SR_) 06/05→								
 Hauptbremszylinder								
1.2 1.5 dCi	74 50 - 63	11/07→12/11 06/05→07/10		→ 11/07; für Linkslenker; - ESP → 11/07; für Linkslenker; + ESP		03.2123-3241.3 03.2123-3493.3	010882 010792	ATE Ø 23,8 ATE Ø 23,8
1.2 Hi-Flex	58	11/07→12/09		- ABS - ESP + ESP		03.2123-2821.3 03.2123-3241.3 03.2123-3493.3	010944 010882 010792	ATE Ø 23,8 ATE Ø 23,8 ATE Ø 23,8
1.5 dCi	55	08/10→12/14		- ABS für Linkslenker; - ESP für Linkslenker; + ESP		03.2123-2821.3 03.2123-2863.3 03.2123-2923.3	010944 010790 010791	ATE Ø 23,8 ATE Ø 23,8 ATE Ø 23,8
1.5 dCi	78	10/05→10/07		- ABS für Linkslenker; - ESP für Linkslenker; + ESP		03.2123-2821.3 03.2123-3241.3 03.2123-3493.3	010944 010882 010792	ATE Ø 23,8 ATE Ø 23,8 ATE Ø 23,8
1.5 dCi	65	08/10→12/14		→ 12/12; - ABS für Linkslenker; → 12/12; - ESP für Linkslenker; → 12/12; + ESP		03.2123-2821.3 03.2123-2863.3 03.2123-2923.3	010944 010790 010791	ATE Ø 23,8 ATE Ø 23,8 ATE Ø 23,8
RENAULT - CLIO IV (BH_) 11/12→								
 Hauptbremszylinder								
0.9 TCe 75 0.9 TCe 90 0.9 TCe 90 LPG 1.2 16V 1.2 LPG 1.2 LPG 16V	56 66 66 54 - 55 53 54	05/18→ 11/12→ 06/16→ 11/12→ 01/14→ 11/12→06/15		für Linkslenker		24.4120-1771.3	011076	Ø 20,6 ohne Bremsflüssigkeitsbehälter
1.2 TCe 120	87 - 88	03/13→		für Linkslenker für Rechtslenker		24.4123-1723.3 24.4123-1724.3	011074 011075	Ø 23,8 ohne Bremsflüssigkeitsbehälter TRW Ø 23,8 ohne Bremsflüssigkeitsbehälter
1.5 dCi 1.5 dCi 110 1.5 dCi 90	62 - 63 81 66	11/12→ 06/16→ 11/12→		für Linkslenker; Schaltgetriebe für Linkslenker; Automatikgetriebe für Rechtslenker; Automatikgetriebe		24.4120-1771.3 24.4123-1723.3 24.4123-1724.3	011076 011074 011075	Ø 20,6 ohne Bremsflüssigkeitsbehälter Ø 23,8 ohne Bremsflüssigkeitsbehälter TRW Ø 23,8 ohne Bremsflüssigkeitsbehälter
1.5 dCi 75	55	11/12→		für Linkslenker; Schaltgetriebe		24.4120-1771.3	011076	Ø 20,6 ohne Bremsflüssigkeitsbehälter
RENAULT - CLIO IV Grandtour (KH_) 11/12→								
 Hauptbremszylinder								
0.9 TCe 75 0.9 TCe 90 1.2 16V 1.2 TCe 120 1.5 dCi 110 1.5 dCi 75 1.5 dCi 90	56 66 54 87 - 88 81 55 66	08/18→ 01/13→ 01/13→ 03/13→ 01/14→ 06/16→ 01/13→ 11/12→		für Linkslenker		24.4123-1723.3	011074	Ø 23,8 ohne Bremsflüssigkeitsbehälter
RENAULT - CLIO IV Kasten/Kombi (KH_) 01/13→								
 Hauptbremszylinder								
0.9 TCe 90 1.5 dCi 75 1.5 dCi 90	66 55 66	01/14→ 01/14→ 01/14→		für Linkslenker		24.4123-1723.3	011074	Ø 23,8 ohne Bremsflüssigkeitsbehälter
RENAULT - CLIO IV Kasten/Schrägheck (BH_) 01/14→								
 Hauptbremszylinder								
0.9 TCe 90 0.9 TCe 90 LPG 1.2 16V 1.2 16V LPG 1.5 dCi 75	66 66 54 - 55 53 55	01/14→ 08/15→ 01/14→ 01/14→ 01/14→		für Linkslenker für Linkslenker; Schaltgetriebe		24.4120-1771.3 24.4120-1771.3	011076 011076	Ø 20,6 ohne Bremsflüssigkeitsbehälter Ø 20,6 ohne Bremsflüssigkeitsbehälter
1.5 dCi 90	66	01/14→		für Linkslenker; Schaltgetriebe für Linkslenker; Automatikgetriebe für Rechtslenker; Automatikgetriebe		24.4120-1771.3 24.4123-1723.3 24.4123-1724.3	011076 011074 011075	Ø 20,6 ohne Bremsflüssigkeitsbehälter Ø 23,8 ohne Bremsflüssigkeitsbehälter TRW Ø 23,8 ohne Bremsflüssigkeitsbehälter





















	kw			 	! #		
RENAULT - DOKKER 12/13→							
 Hauptbremszylinder							
1.5 dCi 1.6	66 62	12/13→ 12/13→		- ESP		24.4152-0381.3 011032	ATE Ø 22,2 ohne Bremsflüssigkeitsbehälter
				+ ESP		24.4152-0391.3 011033	ATE Ø 22,2 ohne Bremsflüssigkeitsbehälter
RENAULT - DUSTER (HS_) 01/11→							
 Bremskraftverstärker							
1.5 dCi 1.6 16V	63 76	02/12→ 02/12→		→ 10/13; + ABS		03.7853-4602.4 300302	ATE Ø 9" pneumatisch
1.5 dCi 4x4 1.6 16V	66 75 - 84	06/11→ 02/12→		für Linkslenker; + ABS		03.7853-4602.4 300302	ATE Ø 9" pneumatisch
1.6 16V 4x4	75 - 84	06/11→					
2.0	98 -	10/11→					
2.0 4x4	105 99 - 105	10/11→					
1.5 dCi 4x4	80	09/13→01/18		+ ABS		03.7853-4602.4 300302	ATE Ø 9" pneumatisch
 Hauptbremszylinder							
1.5 dCi 1.6 16V	63 76	02/12→ 02/12→		→ 10/13; - ESP		03.2122-2031.3 010938	ATE Ø 22,2
				→ 10/13; + ESP		03.2122-2261.3 010964	ATE Ø 22,2
				11/13→; + ABS / - ESP		24.4152-0381.3 011032	ATE Ø 22,2 ohne Bremsflüssigkeitsbehälter
				11/13→; + ABS / + ESP		24.4152-0391.3 011033	ATE Ø 22,2 ohne Bremsflüssigkeitsbehälter
1.5 dCi 4x4 1.6 16V	66 75 - 84	06/11→ 02/12→		für Linkslenker; + ABS		03.2122-2031.3 010938	ATE Ø 22,2
1.6 16V 4x4	75 - 84	06/11→		für Linkslenker; + ESP		03.2122-2261.3 010964	ATE Ø 22,2
2.0	98 -	10/11→					
2.0 4x4	105 99 - 105	10/11→					
1.5 dCi 4x4	80	09/13→01/18		+ ABS / - ESP		03.2122-2031.3 010938	ATE Ø 22,2
				+ ABS / + ESP		03.2122-2261.3 010964	ATE Ø 22,2
RENAULT - ESPACE III (JE0_) 11/96→10/02							
 Hauptbremszylinder							
1.9 dTi 2.0	72 84 - 102	02/99→10/02 11/96→10/02		+ ABS		03.2123-1486.3 010488	Ø 23,8
2.0 16V	103	10/98→10/02					
2.2 12V TD 2.2 D	83 84	11/96→10/00 11/97→01/00		+ ABS		03.2123-1486.3 010488	Ø 23,8
3.0 V6 24V	140	10/98→10/02		- ABS		03.2123-1741.3 010537	ATE Ø 23,8
2.2 dCi	95	10/00→10/02				03.2123-1486.3 010488	Ø 23,8
2.2 dCi	85	07/00→10/02				03.2123-1741.3 010537	ATE Ø 23,8
RENAULT - ESPACE IV (JK0/1_) 11/02→							
 Bremskraftverstärker							
1.9 dCi 2.0	85 - 88	11/02→		für Linkslenker		03.7868-1602.4 300220	ATE Ø 10 / 8" pneumatisch
2.0 dCi	98 - 125	11/02→					
2.0 Turbo	96 - 127	01/06→					
2.2 dCi	120 102 - 110	11/02→ 11/02→					
3.0 dCi	120 - 133	11/02→					
3.5 V6	177	11/02→					
 Hauptbremszylinder							
1.9 dCi	85 - 88	11/02→		→ 12/04; + ESP		03.4125-0014.3 010794	ATE Ø 25,4
2.0	98 - 100	11/02→12/15		- ESP		03.4125-0021.3 010888	ATE Ø 25,4
2.0 Turbo	120	11/02→		01/05→; + ESP		03.4155-0043.3 010795	ATE Ø 25,4
2.2 dCi	110	11/02→08/06					
3.0 dCi →	130	11/02→08/06					









	kW			 	! #		
RENAULT - ESPACE IV (JK0/1_) 11/02→							
 Hauptbremszylinder							
3.5 V6	177	11/02→		→ 12/04; + ESP		03.4125-0014.3 010794	ATE Ø 25,4
				- ESP		03.4125-0021.3 010888	ATE Ø 25,4
				01/05→; + ESP		03.4155-0043.3 010795	ATE Ø 25,4
2.0	125	04/05→		- ESP		03.4125-0021.3 010888	ATE Ø 25,4
2.0 dCi	96 - 127	01/06→		+ ESP		03.4155-0043.3 010795	ATE Ø 25,4
2.2 dCi	102	02/06→					
3.0 dCi	120 - 133	09/05→					
RENAULT - EXPRESS Pick-up 07/95→10/99							
 Hauptbremszylinder							
1.9 D	47	07/95→10/99		→ 03/98		03.2120-2031.3 010106	ATE Ø 20,6
RENAULT - GRAND SCÉNIC II (JM0/1_) 04/04→06/09							
 Hauptbremszylinder							
1.5 dCi	74 - 76	04/04→11/08				24.2123-1760.3 010779	TRW Ø 23,8
1.6	77 - 83	04/04→11/08				24.4123-1721.3 011052	BOS Ø 23,8 ohne Bremsflüssigkeitsbehälter
1.9 dCi	81 - 88	04/04→01/09					
2.0 dCi	110	09/05→11/08					
1.5 dCi	78	05/05→01/09		06/06→		24.2123-1760.3 010779	TRW Ø 23,8
						24.4123-1721.3 011052	BOS Ø 23,8 ohne Bremsflüssigkeitsbehälter
1.6 Flex	82	06/06→06/09				24.2123-1760.3 010779	TRW Ø 23,8
				→ 03/09		24.4123-1721.3 011052	BOS Ø 23,8 ohne Bremsflüssigkeitsbehälter
1.9 dCi	96	04/04→02/08				24.2123-1760.3 010779	TRW Ø 23,8
				05/05→		24.4123-1721.3 011052	BOS Ø 23,8 ohne Bremsflüssigkeitsbehälter
2.0	99 - 120	04/04→06/09		→ 03/09		24.2123-1760.3 010779	TRW Ø 23,8
						24.4123-1721.3 011052	BOS Ø 23,8 ohne Bremsflüssigkeitsbehälter
RENAULT - GRAND SCÉNIC III (JZ0/1_) 02/09→							
 Hauptbremszylinder							
1.2 TCe	85 - 96	04/12→				24.4123-1715.3 010980	TRW Ø 23,8
1.4 16V	96	02/09→					
1.5 dCi	63 - 81	02/09→					
1.6 16V	81	02/09→					
1.6 16V Bifuel	79 - 81	02/09→					
1.6 dCi	96	04/11→					
1.6 E85	81	02/09→					
1.9 dCi	96	02/09→					
2.0 16V	103	02/09→					
2.0 dCi	110 - 118	02/09→					
1.2 TCe	97	01/13→		03/13→		24.4123-1715.3 010980	TRW Ø 23,8
RENAULT - KADJAR (HA_, HL_) 06/15→							
 Hauptbremszylinder							
1.2 TCe 130	96	06/15→		für Linkslenker		24.4123-1728.3 011089	Ø 23,8 ohne Bremsflüssigkeitsbehälter
1.3 TCe 140	103	08/18→					
1.3 TCe 160	116 - 117	08/18→					
1.5 BLUE dCi 115	85	08/18→					
1.5 dCi 110	81	06/15→					
1.6 dCi 130	96	06/15→					
1.6 dCi 130 4x4	96	06/15→					
1.6 TCe 165	120	11/16→					
1.7 Blue dCi 150	110	08/18→					
1.7 Blue dCi 150 4WD	110	08/18→					
RENAULT - KANGOO / GRAND KANGOO II (KW0/1_) 02/08→							
 Hauptbremszylinder							
1.2 TCe 115	84	07/13→		+ ABS; → 12/14		24.4122-1720.3 011065	ATE Ø 22,2 ohne Bremsflüssigkeitsbehälter
1.5 dCi	78	02/08→					
1.5 dCi 105	76	02/08→					
→							

















	kw			 	! #		
RENAULT - KANGOO / GRAND KANGOO II (KW0/1_) 02/08→							
 Hauptbremszylinder							
1.5 dCi 110	80 - 81	09/10→		+ ABS; → 12/14		24.4122-1720.3 011065	ATE Ø 22,2 ohne Bremsflüssigkeitsbehälter
1.5 dCi 70	50	02/08→					
1.5 dCi 75	55	11/12→					
1.5 dCi 85	63	02/08→					
1.5 dCi 90	66	06/08→					
1.6	64	02/08→					
1.6 16V	78	02/08→					
1.6 16V FLEX	78	02/08→					
1.6 16V LPG	78	12/08→					
RENAULT - KANGOO (KC0/1_) 08/97→							
 Hauptbremszylinder							
1.0	50	01/02→01/07		für Linkslenker		24.2122-1727.3 010586	BDX Ø 22,2
1.0 RN	43	01/02→01/07					
1.2 16V	55	06/01→		→ 12/07; - ABS		24.2122-1727.3 010586	BDX Ø 22,2
1.5 dCi	45 - 60	12/01→					
1.6 16V	70	06/01→					
1.6 16V 4x4	70	10/01→					
1.9 dCi 4x4	59 - 62	10/01→					
1.9 dTi	59	02/00→					
1.9 RXED	48	09/99→06/01		- ABS		24.2122-1727.3 010586	BDX Ø 22,2
D 65 1.9	47	08/97→06/01		03/98→; - ABS		24.2122-1727.3 010586	BDX Ø 22,2
RENAULT - KANGOO BE BOP (KW0/1_) 02/09→							
 Hauptbremszylinder							
1.5 dCi	66 - 80	02/09→		→ 12/10; + ABS		24.4122-1720.3 011065	ATE Ø 22,2 ohne Bremsflüssigkeitsbehälter
1.5 dCi 75	55	09/10→					
1.6	78	02/09→12/12					
RENAULT - KANGOO Express (FC0/1_) 08/97→							
 Hauptbremszylinder							
1.0	43	01/02→01/07		für Linkslenker		24.2122-1727.3 010586	BDX Ø 22,2
1.0	50	01/02→01/07		07/03→; - ABS		24.2122-1727.3 010586	BDX Ø 22,2
1.2	44	07/98→07/01		- ABS		24.2122-1727.3 010586	BDX Ø 22,2
1.2 BiFuel	43	07/98→07/01					
1.6	66	09/99→06/01					
1.9 D	48	09/99→06/03					
1.2 16V	55	10/01→		→ 12/07; - ABS		24.2122-1727.3 010586	BDX Ø 22,2
1.5 dCi	42 - 62	12/01→					
1.6 16V	70	10/01→					
1.6 16V 4x4	70	10/01→					
1.6 16V bivalent	60	06/05→					
1.9 dCi	62	07/03→					
1.9 dCi 4x4	59 - 62	10/01→					
1.9 dTi	59	02/00→					
1.4	55	08/97→06/08		03/98→ 12/07; - ABS		24.2122-1727.3 010586	BDX Ø 22,2
RENAULT - KANGOO Express (FW0/1_) 02/08→							
 Hauptbremszylinder							
1.2 TCe 115	84	07/13→		+ ABS; → 12/14		24.4122-1720.3 011065	ATE Ø 22,2 ohne Bremsflüssigkeitsbehälter
1.5 dCi 105	76	02/08→					
1.5 dCi 110	80 - 81	09/10→					
1.5 dCi 70	50	02/08→					
1.5 dCi 75	55	09/10→					
1.5 dCi 85	63	02/08→					
1.5 dCi 90	66	06/09→					
1.6	64	02/08→					
1.6 16V	78	02/08→					
1.6 16V FLEX	78	02/08→					
1.6 16V LPG	78	02/08→					
Z.E.	44	10/11→					
RENAULT - KAPTUR (H5_) 03/16→							
 Hauptbremszylinder							
1.6	84	03/16→				24.4152-0391.3 011033	ATE Ø 22,2 ohne Bremsflüssigkeitsbehälter
2.0 4WD	105	03/16→					













	kw			 	! #		
RENAULT - KOLEOS II (HC_) 04/16→							
 Hauptbremszylinder							
1.6 dCi 130 1.7 BLUE dCi 150 2.0 BLUE DCi 185 2.0 BLUE DCi 185 4WD 2.0 BLUE dCi 190 4WD 2.0 dCi 175 2.0 dCi 175 4WD 2.0 TCe 2.5 Sce 2.5 Sce 4WD	96 110 135 135 140 130 130 107 126 126	04/16→ 06/19→ 01/20→ 01/20→ 06/19→ 04/16→ 04/16→ 04/16→ 04/16→ 04/16→		für Linkslenker		24.4123-1728.3 011089	Ø 23,8 ohne Bremsflüssigkeitsbehälter
RENAULT - LAGUNA I (B56_, 556_) 11/93→08/02							
 Hauptbremszylinder							
1.6 16V 1.8 16V 1.9 dTi 3.0 24V	79 88 72 140	11/97→03/01 04/98→03/01 10/97→03/01 03/97→03/01		02/99→ 02/01 → 01/99		24.2123-1701.3 010424 24.2123-1725.3 010549	Ø 23,8 Ø 23,8
1.8	69	06/95→02/01		- ABS → 01/97; + ABS 02/97→; + ABS		03.2122-1001.3 010562 10.6123-0312.3 010457 24.2123-1725.3 010549	Ø 22,2 ATE Ø 23,8 Ø 23,8
1.8 2.2 D	66 - 69 61	11/93→03/01 11/93→03/01		→ 02/01; - ABS → 01/97; + ABS 02/97→ 02/01; + ABS		03.2122-1001.3 010562 10.6123-0312.3 010457 24.2123-1725.3 010549	Ø 22,2 ATE Ø 23,8 Ø 23,8
1.8	66	08/95→03/01		02/99→ 02/01; + ABS 02/97→ 02/01; + ABS		24.2123-1701.3 010424 24.2123-1725.3 010549	Ø 23,8 Ø 23,8
1.9 dCi 2.0 2.0 16V	79 80 103	09/99→03/01 03/99→03/01 09/99→03/01		→ 02/01		24.2123-1701.3 010424	Ø 23,8
2.0	84	06/95→02/01		→ 01/97; + ABS		10.6123-0312.3 010457	ATE Ø 23,8
2.0	83	11/93→03/01		02/97→ 02/01; + ABS → 02/01; - ABS		24.2123-1725.3 010549 24.2123-1725.3 010549	Ø 23,8 Ø 23,8
2.0 16V	102	06/95→03/01		→ 02/01; + ABS 02/99→ 02/01; + ABS 02/97→ 01/99; + ABS → 02/01; - ABS		10.6123-0312.3 010457 24.2123-1701.3 010424 24.2123-1725.3 010549 24.2123-1725.3 010549	ATE Ø 23,8 Ø 23,8 Ø 23,8 Ø 23,8
2.2 dT	83	03/96→03/01		→ 01/97; + ABS 02/99→ 02/01; + ABS 02/97→ 01/99; + ABS → 02/01; - ABS		10.6123-0312.3 010457 24.2123-1701.3 010424 24.2123-1725.3 010549 24.2123-1725.3 010549	ATE Ø 23,8 Ø 23,8 Ø 23,8 Ø 23,8
3.0	123	11/93→03/01		→ 01/97; + ABS 02/97→ 02/01		10.6123-0312.3 010457 24.2123-1725.3 010549	ATE Ø 23,8 Ø 23,8
RENAULT - LAGUNA I Grandtour (K56_) 09/95→08/02							
 Hauptbremszylinder							
1.6 16V 1.8 16V 1.9 dTi 3.0 24V	79 88 72 140	11/97→03/01 04/98→03/01 10/97→03/01 03/97→03/01		02/99→ 02/01 → 01/99		24.2123-1701.3 010424 24.2123-1725.3 010549	Ø 23,8 Ø 23,8
1.8	66	09/95→03/01		→ 01/97; + ABS 02/99→ 02/01; + ABS 02/97→ 02/01; + ABS 02/97→ 01/99; + ABS → 02/01; - ABS		10.6123-0312.3 010457 24.2123-1701.3 010424 24.2123-1725.3 010549 24.2123-1725.3 010549 24.2123-1725.3 010549	ATE Ø 23,8 Ø 23,8 Ø 23,8 Ø 23,8 Ø 23,8
1.8 2.2 D	69 61	09/95→03/01 09/95→03/01		→ 01/97; + ABS 02/97→ 02/01; + ABS → 02/01; - ABS		10.6123-0312.3 010457 24.2123-1725.3 010549 24.2123-1725.3 010549	ATE Ø 23,8 Ø 23,8 Ø 23,8
1.9 dCi	79	09/99→03/01		→ 02/01		24.2123-1701.3 010424	Ø 23,8
2.0	84	10/98→01/01		+ ABS - ABS		10.6123-0312.3 010457 24.2123-1725.3 010549	ATE Ø 23,8 Ø 23,8
2.0	83	09/95→03/01		→ 01/97; + ABS 11/95→ 01/97; + ABS → 02/01; + ABS 02/99→ 02/01; + ABS 11/95→ 02/01; - ABS 02/97→ 02/01; + ABS 02/97→ 01/99; + ABS		10.6123-0312.3 010457 10.6123-0312.3 010457 10.6123-0312.3 010457 24.2123-1701.3 010424 24.2123-1725.3 010549 24.2123-1725.3 010549 24.2123-1725.3 010549	ATE Ø 23,8 ATE Ø 23,8 ATE Ø 23,8 Ø 23,8 Ø 23,8 Ø 23,8 Ø 23,8













	kw					! #		
RENAULT - LAGUNA I Grandtour (K56_) 09/95→08/02								
 Hauptbremszylinder								
2.0	83	09/95→03/01		→ 02/01			24.2123-1725.3 010549	Ø 23,8
				→ 02/01; - ABS			24.2123-1725.3 010549	Ø 23,8
2.0 16V	102	09/95→03/01		→ 01/97; + ABS			10.6123-0312.3 010457	ATE Ø 23,8
				→ 02/01; + ABS			10.6123-0312.3 010457	ATE Ø 23,8
				02/99→ 02/01; + ABS			24.2123-1701.3 010424	Ø 23,8
				09/99→ 02/01			24.2123-1701.3 010424	Ø 23,8
				02/97→ 01/99			24.2123-1725.3 010549	Ø 23,8
				→ 02/01; - ABS			24.2123-1725.3 010549	Ø 23,8
2.2 dT	83	03/96→03/01		→ 01/97; + ABS			10.6123-0312.3 010457	ATE Ø 23,8
				02/99→ 02/01; + ABS			24.2123-1701.3 010424	Ø 23,8
				02/97→ 01/99; + ABS			24.2123-1725.3 010549	Ø 23,8
				→ 02/01; - ABS			24.2123-1725.3 010549	Ø 23,8
3.0	123	02/96→03/01		03/96→ 01/97; + ABS			10.6123-0312.3 010457	ATE Ø 23,8
				→ 02/01; + ABS			10.6123-0312.3 010457	ATE Ø 23,8
				02/97→ 02/01			24.2123-1725.3 010549	Ø 23,8
RENAULT - LAGUNA II (BG0/1_) 03/01→12/07								
 Bremskraftverstärker								
1.6 1.6 16V 1.6 LPG 1.8 16V	76 79 79 86 - 89	03/01→05/05 03/01→05/05 03/01→05/05 03/01→05/05		06/01→; für Linkslenker			03.7873-1202.4 300197	ATE Ø 11" pneumatisch
1.6 16V 1.9 dCi 2.0 16V 2.0 dCi 2.2 dCi	82 79 - 96 99 - 150 127 102	02/05→08/07 03/01→12/07 08/02→12/07 01/06→08/07 05/05→08/07		→ 06/07; für Linkslenker			03.7873-1202.4 300197	ATE Ø 11" pneumatisch
1.8 16V 1.9 dCi 2.0 16V IDE 3.0 V6 24V	85 - 88 88 103 152	03/01→12/07 03/01→09/07 04/01→09/07 03/01→08/07		06/01→ 06/07; für Linkslenker			03.7873-1202.4 300197	ATE Ø 11" pneumatisch
1.9 dCi 1.9 dCi 2.0 16V 2.0 16V Turbo 2.0 dCi 2.2 dCi	68 - 74 77 98 120 110 85 - 110	10/01→05/05 06/01→05/05 08/02→12/06 01/03→03/05 08/05→08/06 10/01→08/06		für Linkslenker			03.7873-1202.4 300197	ATE Ø 11" pneumatisch
Pedalwegsensoren, Bremspedal								
1.6 1.6 16V 1.6 LPG 1.8 16V	76 79 79 86 - 89	03/01→05/05 03/01→05/05 03/01→05/05 03/01→05/05		→ 05/01; für Linkslenker			03.0655-0007.2 370007	ATE
				für Rechtslenker			03.0655-0007.2 370007	ATE
1.6 16V 1.9 dCi 2.0 16V 2.0 dCi 2.2 dCi	82 79 - 96 99 - 150 127 102	02/05→08/07 03/01→12/07 08/02→12/07 01/06→08/07 05/05→08/07		→ 06/07; für Rechtslenker			03.0655-0007.2 370007	ATE
1.8 16V 1.9 dCi 2.0 16V IDE 3.0 V6 24V	85 - 88 88 103 152	03/01→12/07 03/01→09/07 04/01→09/07 03/01→08/07		→ 05/01; für Linkslenker			03.0655-0007.2 370007	ATE
				→ 06/07; für Rechtslenker			03.0655-0007.2 370007	ATE
1.9 dCi 1.9 dCi 2.0 16V 2.0 16V Turbo 2.0 dCi 2.2 dCi	68 - 74 77 98 120 110 85 - 110	10/01→05/05 06/01→05/05 08/02→12/06 01/03→03/05 08/05→08/06 10/01→08/06		für Rechtslenker			03.0655-0007.2 370007	ATE
2.9 V6 24V	155	03/01→08/07					03.0655-0007.2 370007	ATE
 Hauptbremszylinder								
1.6 →	76	03/01→05/05		→ 03/05			03.4123-0081.3 010585	ATE Ø 23,8







	kW			 	! #		
RENAULT - LAGUNA II (BG0/1_) 03/01→12/07							
 Hauptbremszylinder							
1.6 16V 1.6 LPG 1.8 16V 1.9 dCi 1.9 dCi 2.0 16V 2.2 dCi	79 79 86 - 89 68 - 74 77 98 85 - 110	03/01→05/05 03/01→05/05 03/01→05/05 10/01→05/05 06/01→05/05 08/02→12/06 10/01→08/06		04/05→		03.4153-0063.3 010773	ATE Ø 23,8
1.6 16V 1.9 dCi 2.0 dCi 2.2 dCi	82 85 - 96 127 102	02/05→08/07 05/05→12/07 01/06→08/07 05/05→08/07		→ 06/07		03.4153-0063.3 010773	ATE Ø 23,8
1.8 16V 1.9 dCi 2.0 16V 2.0 16V IDE 3.0 V6 24V	85 - 88 79 - 88 99 - 150 103 152	03/01→12/07 03/01→09/07 08/02→12/07 04/01→09/07 03/01→08/07		→ 03/05 04/05→ 06/07		03.4123-0081.3 010585 03.4153-0063.3 010773	ATE Ø 23,8 ATE Ø 23,8
2.0 16V Turbo 2.0 dCi 2.9 V6 24V	120 110 155	01/03→03/05 08/05→08/06 03/01→08/07				03.4153-0063.3 010773 03.4123-0081.3 010585	ATE Ø 23,8 ATE Ø 23,8
Verschlusschraube, Hauptbremszylinder							
1.6 1.6 16V 1.6 LPG 1.8 16V 1.9 dCi 1.9 dCi 2.0 16V 2.0 16V IDE 2.2 dCi 3.0 V6 24V 2.9 V6 24V	76 79 79 85 - 89 68 - 88 77 98 - 150 103 85 - 110 152 155	03/01→05/05 03/01→05/05 03/01→05/05 03/01→12/07 03/01→09/07 06/01→05/05 08/02→12/07 04/01→09/07 10/01→08/06 03/01→08/07 03/01→08/07		→ 03/05; - ESP - ESP		03.3517-0300.1 390323 03.3517-0300.1 390323	
RENAULT - LAGUNA II Grandtour (KG0/1_) 03/01→12/07							
 Bremskraftverstärker							
1.6 1.8 16V 3.0 V6 24V	76 85 - 89 152	03/01→10/05 03/01→05/05 03/01→12/07		06/01→; für Linkslenker		03.7873-1202.4 300197	ATE Ø 11" pneumatisch
1.6 16V 1.6 Bifuel 1.9 dCi 2.0 16V 2.0 dCi 2.2 dCi	82 79 79 - 96 98 - 150 127 102	02/05→08/07 06/05→12/07 03/01→12/07 08/02→12/07 01/06→12/07 05/05→12/07		→ 06/07; für Linkslenker		03.7873-1202.4 300197	ATE Ø 11" pneumatisch
1.6 16V 1.9 dCi 2.0 16V IDE 1.9 dCi	79 88 103 66	03/01→12/07 03/01→09/07 04/01→09/07 08/03→09/07		06/01→ 06/07; für Linkslenker 03/04→ 06/07; für Linkslenker		03.7873-1202.4 300197 03.7873-1202.4 300197	ATE Ø 11" pneumatisch ATE Ø 11" pneumatisch
1.9 dCi 1.9 dCi 2.0 16V Turbo 2.0 dCi 2.2 dCi 2.9 V6 24V	68 - 74 77 120 110 85 - 110 155	10/01→05/05 06/01→05/05 01/03→08/05 08/05→08/06 10/01→08/06 10/03→12/07		für Linkslenker		03.7873-1202.4 300197	ATE Ø 11" pneumatisch
Pedalwegsensor, Bremspedal							
1.6 1.8 16V 3.0 V6 24V	76 85 - 89 152	03/01→10/05 03/01→05/05 03/01→12/07		→ 05/01; für Linkslenker für Rechtslenker		03.0655-0007.2 370007 03.0655-0007.2 370007	ATE ATE
1.6 16V 1.6 Bifuel 1.9 dCi	82 79 79 - 96	02/05→08/07 06/05→12/07 03/01→12/07		→ 06/07; für Rechtslenker		03.0655-0007.2 370007	ATE











	kW					! #		
RENAULT - LAGUNA II Grandtour (KG0/1_) 03/01→12/07								
Pedalwegsensord, Bremspedal								
2.0 16V	98 - 150	08/02→12/07		→ 06/07; für Rechtslenker		03.0655-0007.2	370007	ATE
2.0 dCi	127	01/06→12/07						
2.2 dCi	102	05/05→12/07						
1.6 16V	79	03/01→12/07		→ 05/01; für Linkslenker		03.0655-0007.2	370007	ATE
2.0 16V IDE	103	04/01→09/07		→ 06/07; für Rechtslenker		03.0655-0007.2	370007	ATE
1.9 dCi	66	08/03→09/07		03/04→ 06/07; für Rechtslenker		03.0655-0007.2	370007	ATE
1.9 dCi	68 - 74	10/01→05/05		für Rechtslenker		03.0655-0007.2	370007	ATE
1.9 dCi	77	06/01→05/05						
2.0 16V Turbo	120	01/03→08/05						
2.0 dCi	110	08/05→08/06						
2.2 dCi	85 - 110	10/01→08/06						
2.9 V6 24V	155	10/03→12/07						
1.9 dCi	88	03/01→09/07		→ 05/01; für Linkslenker		03.0655-0007.2	370007	ATE
				06/01→ 06/07; für Rechtslenker		03.0655-0007.2	370007	ATE
 Hauptbremszylinder								
1.6	76	03/01→10/05		→ 03/05		03.4123-0081.3	010585	ATE Ø 23,8
1.8 16V	85 - 89	03/01→05/05		04/05→		03.4153-0063.3	010773	ATE Ø 23,8
1.9 dCi	68 - 74	10/01→05/05						
1.9 dCi	77	06/01→05/05						
2.2 dCi	85 - 110	10/01→08/06						
2.9 V6 24V	155	10/03→12/07						
3.0 V6 24V	152	03/01→12/07						
1.6 16V	79 - 82	03/01→12/07		→ 03/05		03.4123-0081.3	010585	ATE Ø 23,8
1.9 dCi	79 - 88	03/01→12/07		04/05→ 06/07		03.4153-0063.3	010773	ATE Ø 23,8
2.0 16V	98 - 99	08/02→12/07						
2.0 16V IDE	103	04/01→09/07						
1.6 Bifuel	79	06/05→12/07		→ 06/07		03.4153-0063.3	010773	ATE Ø 23,8
1.9 dCi	85 - 96	05/05→12/07						
2.0 16V	125 - 150	01/05→09/07						
2.0 dCi	127	01/06→12/07						
2.2 dCi	102	05/05→12/07						
1.9 dCi	66	08/03→09/07		03/04→ 03/05		03.4123-0081.3	010585	ATE Ø 23,8
				04/05→ 06/07		03.4153-0063.3	010773	ATE Ø 23,8
1.9 dCi	81	01/05→12/07		→ 03/05		03.4123-0081.3	010585	ATE Ø 23,8
				→ 06/07		03.4153-0063.3	010773	ATE Ø 23,8
2.0 16V Turbo	120	01/03→08/05				03.4153-0063.3	010773	ATE Ø 23,8
2.0 dCi	110	08/05→08/06						
Verschlusschraube, Hauptbremszylinder								
1.6	76	03/01→10/05		→ 03/05; - ESP		03.3517-0300.1	390323	
1.6 16V	79 - 82	03/01→12/07						
1.8 16V	85 - 89	03/01→05/05						
1.9 dCi	68 - 88	03/01→12/07						
1.9 dCi	77	06/01→05/05						
2.0 16V	98 - 99	08/02→12/07						
2.0 16V IDE	103	04/01→09/07						
2.2 dCi	85 - 110	10/01→08/06						
2.9 V6 24V	155	10/03→12/07						
3.0 V6 24V	152	03/01→12/07						
1.9 dCi	66	08/03→09/07		03/04→ 03/05; - ESP		03.3517-0300.1	390323	
RENAULT - LODGY (JS_) 07/13→								
 Hauptbremszylinder								
1.5 dCi	62	01/15→		- ESP		24.4152-0381.3	011032	ATE Ø 22,2 ohne Bremsflüssigkeitsbehälter
1.6	59	07/13→		+ ESP		24.4152-0391.3	011033	ATE Ø 22,2 ohne Bremsflüssigkeitsbehälter











	kw			 	! #		
RENAULT - LOGAN/STEPWAY II (L8_) 09/12→							
 Hauptbremszylinder							
1.2	55	11/13→		für Linkslenker; + ABS		24.4120-1771.3 011076	Ø 20,6 ohne Bremsflüssigkeitsbehälter
1.2 16V LPG	53	11/13→					
1.5 dCi	62 - 66	12/13→					
1.6	59 - 83	11/13→					
RENAULT - LOGAN I (LS_) 09/04→							
 Bremskraftverstärker							
1.4	55	09/04→		→ 10/09; + ABS		03.7750-8532.4 300264	ATE Ø 9" pneumatisch
1.4 LPG	53	02/08→10/13		11/09→; + ABS		03.7853-4602.4 300302	ATE Ø 9" pneumatisch
1.5 dCi	48	04/06→10/13		→ 04/13; + ABS		03.7853-4602.4 300302	ATE Ø 9" pneumatisch
1.5 dCi	50 - 63	04/07→		→ 10/09; + ABS		03.7750-8532.4 300264	ATE Ø 9" pneumatisch
1.6	64 - 77	09/04→		11/09→ 04/13; + ABS		03.7853-4602.4 300302	ATE Ø 9" pneumatisch
 Hauptbremszylinder							
1.4	55	09/04→		+ ABS		24.2120-1754.3 010949	Ø 20,6
1.4 LPG	53	02/08→10/13		- ABS		24.2120-1762.3 011002	Ø 20,6 ohne Bremsflüssigkeitsbehälter
1.5 dCi	48 - 63	04/06→		+ ABS; → 04/13		24.2120-1754.3 010949	Ø 20,6
1.6	64 - 77	09/04→		- ABS; → 04/13		24.2120-1762.3 011002	Ø 20,6 ohne Bremsflüssigkeitsbehälter
RENAULT - LOGAN I Kombi (KS_) 04/07→							
 Bremskraftverstärker							
1.4	55	10/07→		→ 10/09; + ABS		03.7750-8532.4 300264	ATE Ø 9" pneumatisch
1.5 dCi	50 - 63	04/07→		11/09→ 04/13; + ABS		03.7853-4602.4 300302	ATE Ø 9" pneumatisch
1.6	64 - 77	04/07→					
1.5 dCi	66	06/11→06/15		→ 04/13; + ABS		03.7853-4602.4 300302	ATE Ø 9" pneumatisch
 Hauptbremszylinder							
1.4	55	10/07→		+ ABS; → 04/13		24.2120-1754.3 010949	Ø 20,6
1.5 dCi	50 - 66	04/07→		- ABS; → 04/13		24.2120-1762.3 011002	Ø 20,6 ohne Bremsflüssigkeitsbehälter
1.6	64 - 77	04/07→					
RENAULT - LOGAN II Kombi (K8_) 11/13→							
 Hauptbremszylinder							
1.2 16V	54	12/13→		für Linkslenker; + ABS		24.4120-1771.3 011076	Ø 20,6 ohne Bremsflüssigkeitsbehälter
1.2 16V LPG	53	12/13→					
1.5 dCi	62 - 66	12/13→					
1.6	59 - 78	12/13→					
RENAULT - LOGAN EXPRESS (US_) 04/07→							
 Bremskraftverstärker							
1.5 dCi	50	04/07→		→ 04/13; + ABS		03.7750-8532.4 300264	ATE Ø 9" pneumatisch
1.6	64	04/07→					
 Hauptbremszylinder							
1.5 dCi	50	04/07→		09/07→ 04/13; + ABS		03.2122-2031.3 010938	ATE Ø 22,2
1.6	64	04/07→					
RENAULT - MASTER II Bus (JD) 03/98→							
 Hauptbremszylinder							
1.9 dCi 80	60	11/01→		→ 10/03; + ABS		24.2025-1706.3 010676	Ø 25,4
1.9 dTI	59	09/00→		11/03→ 08/06; - ABS		24.2025-1708.3 010692	Ø 25,4
2.2 dCI 90	66	09/00→		→ 10/03; - ABS		24.2025-1708.3 010692	Ø 25,4
2.5 dCi 120	84	10/01→		11/03→ 08/06; + ABS		24.2123-1759.3 010768	BOS Ø 23,8
2.5 D	59	07/98→01/01		+ ABS		24.2025-1706.3 010676	Ø 25,4
2.8 dTI	84	07/98→10/01		- ABS		24.2025-1708.3 010692	Ø 25,4
2.5 dCi	74 - 107	08/06→		- ABS; → 12/10		24.2025-1708.3 010692	Ø 25,4
→							









	kw					! #		
RENAULT - MASTER II Bus (JD) 03/98→								
 Hauptbremszylinder								
2.5 dCi 100	73	10/03→			→ 08/06; - ABS		24.2025-1708.3 010692	Ø 25,4
3.0 dCi 140	100	10/03→			→ 08/06; + ABS		24.2123-1759.3 010768	BOS Ø 23,8
RENAULT - MASTER II Kasten (FD) 07/98→								
 Hauptbremszylinder								
1.9 dCi 80	60	11/01→			→ 10/03; + ABS		24.2025-1706.3 010676	Ø 25,4
1.9 dTi	59	09/00→			11/03→ 08/06; - ABS		24.2025-1708.3 010692	Ø 25,4
2.2 dCi 90	66	09/00→						
2.5 dCi 120	84	10/01→			→ 10/03; - ABS		24.2025-1708.3 010692	Ø 25,4
					11/03→ 08/06; + ABS		24.2123-1759.3 010768	BOS Ø 23,8
2.5 D	59	07/98→01/01			+ ABS		24.2025-1706.3 010676	Ø 25,4
2.8 D	63	01/02→09/04			- ABS		24.2025-1708.3 010692	Ø 25,4
2.8 dTi	84	07/98→10/01						
2.5 dCi	74	08/06→01/10			- ABS		24.2025-1708.3 010692	Ø 25,4
2.5 dCi	88 - 107	08/06→			- ABS; → 12/10		24.2025-1708.3 010692	Ø 25,4
2.5 dCi 100	73	10/03→			→ 08/06; - ABS		24.2025-1708.3 010692	Ø 25,4
3.0 dCi 140	100	10/03→10/06			→ 08/06; + ABS		24.2123-1759.3 010768	BOS Ø 23,8
RENAULT - MASTER II Pritsche/Fahrgestell (ED/HD/UD) 07/98→								
 Hauptbremszylinder								
2.2 dCi 90	66	09/00→			→ 10/03; + ABS		24.2025-1706.3 010676	Ø 25,4
2.5 dCi 120	84	10/01→			11/03→ 08/06; - ABS		24.2025-1708.3 010692	Ø 25,4
					→ 10/03; - ABS		24.2025-1708.3 010692	Ø 25,4
					11/03→ 08/06; + ABS		24.2123-1759.3 010768	BOS Ø 23,8
2.5 D	59	07/98→01/01			+ ABS		24.2025-1706.3 010676	Ø 25,4
2.8 dTi	84	07/98→10/01			- ABS		24.2025-1708.3 010692	Ø 25,4
2.5 dCi	74 - 107	08/06→			- ABS; → 12/10		24.2025-1708.3 010692	Ø 25,4
2.5 dCi 100	73	10/03→			→ 08/06; - ABS		24.2025-1708.3 010692	Ø 25,4
3.0 dCi 140	100	10/03→			→ 08/06; + ABS		24.2123-1759.3 010768	BOS Ø 23,8
RENAULT - MASTER III Bus (JV) 02/11→								
 Bremskraftverstärker								
2.3 dCi 100 FWD	74	02/11→					03.7868-5202.4 300309	ATE Ø 10 / 8" pneumatisch
2.3 dCi 110 FWD	81	09/14→						
2.3 dCi 125 FWD	92	02/11→						
2.3 dCi 135 FWD	100	07/14→						
2.3 dCi 145 FWD	107	02/11→						
2.3 dCi 165 FWD	120	07/14→						
2.3 dCi 170 FWD	125	07/15→						
2.3 dCi 180 FWD	132	01/20→						
2.3 dCi 150 FWD	110	10/12→			01/13→		03.7868-5202.4 300309	ATE Ø 10 / 8" pneumatisch
 Hauptbremszylinder								
2.3 dCi 100 FWD	74	02/11→					03.2126-3121.3 010967	ATE Ø 27
2.3 dCi 110 FWD	81	09/14→						
2.3 dCi 125 FWD	92	02/11→						
2.3 dCi 135 FWD	100	07/14→						
2.3 dCi 145 FWD	107	02/11→						
2.3 dCi 165 FWD	120	07/14→						
2.3 dCi 170 FWD	125	07/15→						
2.3 dCi 180 FWD	132	01/20→						
2.3 dCi 150 FWD	110	10/12→			01/13→		03.2126-3121.3 010967	ATE Ø 27
RENAULT - MASTER III Kasten (FV) 02/10→								
 Bremskraftverstärker								
2.3 dCi 100 FWD	74	02/10→					03.7868-5202.4 300309	ATE Ø 10 / 8" pneumatisch
2.3 dCi 100 RWD	74	02/10→						
2.3 dCi 110 FWD	81	09/14→						
2.3 dCi 125 FWD	92	02/10→						
2.3 dCi 125 RWD	92	02/10→						
2.3 dCi 130 FWD	96	06/16→						
2.3 dCi 130 RWD	96	03/12→						
2.3 dCi 135 FWD	100	07/14→						
2.3 dCi 135 RWD	100	07/14→						
2.3 dCi 145 FWD	107	02/10→						
2.3 dCi 145 RWD	107	02/10→						
2.3 dCi 150 FWD	110	03/13→						
2.3 dCi 150 RWD	110	03/13→						
2.3 dCi 165 FWD	120	07/14→						
2.3 dCi 165 RWD	120	07/14→						

	kw			 	! #		
RENAULT - MASTER III Kasten (FV) 02/10→							
 Bremskraftverstärker							
2.3 dCi 170 FWD	125	07/15→				03.7868-5202.4 300309	ATE Ø 10 / 8" pneumatisch
2.3 dCi 180 FWD	132	07/19→					
Z.E.	57	03/18→					
 Hauptbremszylinder							
2.3 dCi 100 FWD	74	02/10→				03.2126-3121.3 010967	ATE Ø 27
2.3 dCi 100 RWD	74	02/10→					
2.3 dCi 110 FWD	81	09/14→					
2.3 dCi 125 FWD	92	02/10→					
2.3 dCi 125 RWD	92	02/10→					
2.3 dCi 130 FWD	96	06/16→					
2.3 dCi 130 RWD	96	03/12→					
2.3 dCi 135 FWD	100	07/14→					
2.3 dCi 135 RWD	100	07/14→					
2.3 dCi 145 FWD	107	02/10→					
2.3 dCi 145 RWD	107	02/10→					
2.3 dCi 150 FWD	110	03/13→					
2.3 dCi 150 RWD	110	03/13→					
2.3 dCi 165 FWD	120	07/14→					
2.3 dCi 165 RWD	120	07/14→					
2.3 dCi 170 FWD	125	07/15→					
2.3 dCi 180 FWD	132	07/19→					
Z.E.	57	03/18→					
RENAULT - MASTER III Pritsche/Fahrgestell (EV, HV, UV) 02/10→							
 Bremskraftverstärker							
2.3 dCi 100 FWD	74	02/10→				03.7868-5202.4 300309	ATE Ø 10 / 8" pneumatisch
2.3 dCi 100 RWD	74	02/10→					
2.3 dCi 110 FWD	81	09/14→					
2.3 dCi 125 FWD	92	02/10→					
2.3 dCi 125 RWD	92	02/10→					
2.3 dCi 130 FWD	96	03/12→					
2.3 dCi 130 RWD	96	07/16→					
2.3 dCi 135 FWD	100	07/14→					
2.3 dCi 135 RWD	100	07/14→					
2.3 dCi 145 FWD	107	02/10→					
2.3 dCi 145 RWD	107	02/10→					
2.3 dCi 150 FWD	110	03/13→					
2.3 dCi 150 RWD	110	03/13→					
2.3 dCi 165 FWD	120	07/14→					
2.3 dCi 165 RWD	120	07/14→					
2.3 dCi 170 FWD	125	06/16→					
2.3 dCi 180 FWD	132	07/19→					
Z.E.	57	03/18→					
 Hauptbremszylinder							
2.3 dCi 100 FWD	74	02/10→				03.2126-3121.3 010967	ATE Ø 27
2.3 dCi 100 RWD	74	02/10→					
2.3 dCi 110 FWD	81	09/14→					
2.3 dCi 125 FWD	92	02/10→					
2.3 dCi 125 RWD	92	02/10→					
2.3 dCi 130 FWD	96	03/12→					
2.3 dCi 130 RWD	96	07/16→					
2.3 dCi 135 FWD	100	07/14→					
2.3 dCi 135 RWD	100	07/14→					
2.3 dCi 145 FWD	107	02/10→					
2.3 dCi 145 RWD	107	02/10→					
2.3 dCi 150 FWD	110	03/13→					
2.3 dCi 150 RWD	110	03/13→					
2.3 dCi 165 FWD	120	07/14→					
2.3 dCi 165 RWD	120	07/14→					
2.3 dCi 170 FWD	125	06/16→					
2.3 dCi 180 FWD	132	07/19→					
Z.E.	57	03/18→					
RENAULT - MEGANE I (BA0/1_) 08/95→12/04							
 Bremskraftverstärker							
1.4 16V	70	03/99→08/03		→ 12/02; + ABS; für Linkslenker	03.7760-5502.4 300151	ATE Ø 10" pneumatisch	
				→ 12/02; - ABS	03.7863-2002.4 300126	ATE Ø 10" pneumatisch	
1.4 e	55	01/96→08/03		03/99→ 12/02; + ABS; für Linkslenker	03.7760-5502.4 300151	ATE Ø 10" pneumatisch	
				03/99→ 12/02; - ABS	03.7760-5602.4 300121	ATE Ø 10" pneumatisch	
1.6 16V	81	11/01→12/04		→ 12/02; + ABS; für Linkslenker; für Fahrzeuge ohne verstärktes Fahrwerk	03.7760-5102.4 300140	ATE Ø 10" pneumatisch	
				→ 12/02; + ABS; für Linkslenker	03.7760-5502.4 300151	ATE Ø 10" pneumatisch	
					03.7863-2002.4 300126	ATE Ø 10" pneumatisch	
→							











	kw			 	! #		
RENAULT - MEGANE I (BA0/1_) 08/95→12/04							
Bremskraftverstärker							
1.6 16V	81	11/01→12/04		→ 12/02; + ABS; für Linkslenker; für Fahrzeuge mit verstärktem Fahrwerk	03.7760-5502.4	300151	ATE Ø 10" pneumatisch
				→ 12/02; - ABS; für Fahrzeuge mit verstärktem Fahrwerk	03.7760-5602.4	300121	ATE Ø 10" pneumatisch
				→ 12/02; - ABS	03.7760-5602.4	300121	ATE Ø 10" pneumatisch
1.6 16V 1.6 LPG	79 80	03/99→08/02 10/00→08/02		+ ABS; für Linkslenker; für Fahrzeuge ohne verstärktes Fahrwerk	03.7760-5102.4	300140	ATE Ø 10" pneumatisch
				+ ABS; für Linkslenker	03.7760-5502.4	300151	ATE Ø 10" pneumatisch
				+ ABS; für Linkslenker; für Fahrzeuge mit verstärktem Fahrwerk	03.7760-5502.4	300151	ATE Ø 10" pneumatisch
				- ABS	03.7760-5602.4	300121	ATE Ø 10" pneumatisch
				- ABS; für Fahrzeuge mit verstärktem Fahrwerk	03.7760-5602.4	300121	ATE Ø 10" pneumatisch
1.8 16V	85	01/01→08/03		→ 12/02; für Linkslenker	03.7863-2002.4	300126	ATE Ø 10" pneumatisch
1.9 dCi	75	02/01→08/03		→ 12/02; + ABS; für Linkslenker	03.7760-5102.4	300140	ATE Ø 10" pneumatisch
				→ 12/02; - ABS	03.7863-2002.4	300126	ATE Ø 10" pneumatisch
				→ 12/02; - ABS	03.7760-5602.4	300121	ATE Ø 10" pneumatisch
1.9 D Eco	47	01/96→08/03		06/98→ 12/02; + ABS; für Linkslenker	03.7760-5502.4	300151	ATE Ø 10" pneumatisch
				06/98→ 12/02; - ABS	03.7760-5602.4	300121	ATE Ø 10" pneumatisch
1.9 dTi	72	03/97→02/01		03/99→; für Linkslenker	03.7760-5102.4	300140	ATE Ø 10" pneumatisch
1.9 dTi	59	02/01→08/03		→ 12/02; + ABS; für Linkslenker	03.7863-2002.4	300126	ATE Ø 10" pneumatisch
Hauptbremszylinder							
1.4 16V	70	03/99→08/03		→ 12/02; für Rechtslenker	03.2120-4441.3	010510	ATE Ø 20,6
				→ 12/02; - ABS	03.2122-1541.3	010511	Ø 22,2
1.4 e	55	01/96→08/03		→ 12/02; - ABS	03.2120-2031.3	010106	ATE Ø 20,6
				06/98→ 02/99; - ABS	03.2120-2031.3	010106	ATE Ø 20,6
				06/98→ 02/99; + ABS	03.2120-4441.3	010510	ATE Ø 20,6
				03/99→ 12/02; - ABS	03.2122-1541.3	010511	Ø 22,2
				→ 12/02; + ABS; für Linkslenker	24.2120-1723.3	010545	BDX Ø 20,6
				→ 12/02; + ABS; für Rechtslenker	24.2120-1725.3	010579	BDX Ø 20,6
1.4 Eco 1.6 i	52 55	01/96→03/99 01/96→03/99		- ABS	03.2120-2031.3	010106	ATE Ø 20,6
				+ ABS	24.2120-1723.3	010545	BDX Ø 20,6
1.6 16V	81	11/01→12/04		→ 12/02; - ABS	03.2122-1541.3	010511	Ø 22,2
				→ 12/02; - ABS; für Fahrzeuge mit verstärktem Fahrwerk	03.2122-1541.3	010511	Ø 22,2
				→ 12/02; + ABS; für Linkslenker; für Fahrzeuge ohne verstärktes Fahrwerk	03.2123-2146.3	010572	Ø 23,8
				→ 12/02; + ABS; für Linkslenker	03.2123-2146.3	010572	Ø 23,8
1.6 16V 1.6 LPG	79 80	03/99→08/02 10/00→08/02		- ABS	03.2122-1541.3	010511	Ø 22,2
				- ABS; für Fahrzeuge mit verstärktem Fahrwerk	03.2122-1541.3	010511	Ø 22,2
				+ ABS; für Linkslenker; für Fahrzeuge ohne verstärktes Fahrwerk	03.2123-2146.3	010572	Ø 23,8
				+ ABS; für Linkslenker	03.2123-2146.3	010572	Ø 23,8
1.6 e	66	01/96→03/99		- ABS	03.2120-2031.3	010106	ATE Ø 20,6
				+ ABS	24.2120-1723.3	010545	BDX Ø 20,6
				+ ABS; für Linkslenker	24.2120-1723.3	010545	BDX Ø 20,6
				+ ABS; für Rechtslenker	24.2120-1725.3	010579	BDX Ø 20,6
1.6 LPG	66	08/95→03/99		01/96→; - ABS	03.2120-2031.3	010106	ATE Ø 20,6
				01/96→; + ABS	24.2120-1723.3	010545	BDX Ø 20,6
				01/96→; + ABS; für Linkslenker	24.2120-1723.3	010545	BDX Ø 20,6
				01/96→; + ABS; für Rechtslenker	24.2120-1725.3	010579	BDX Ø 20,6
1.8 16V	85	01/01→08/03		→ 12/02; für Linkslenker	03.2123-2146.3	010572	Ø 23,8
1.9 D	69	04/96→02/01		09/96→; - ABS	03.2120-2031.3	010106	ATE Ø 20,6
				09/96→; + ABS	24.2120-1723.3	010545	BDX Ø 20,6
1.9 DCi 1.9 dTi	77 59	03/99→08/03 02/01→08/03		→ 12/02; + ABS; für Linkslenker	03.2123-2146.3	010572	Ø 23,8
1.9 dCi	75	02/01→08/03		→ 12/02; - ABS	03.2122-1541.3	010511	Ø 22,2
				→ 12/02; + ABS; für Linkslenker	03.2123-2146.3	010572	Ø 23,8
1.9 D Eco	47	01/96→08/03		→ 12/02; - ABS; für Rechtslenker	03.2120-2031.3	010106	ATE Ø 20,6
				→ 12/02; - ABS	03.2120-2031.3	010106	ATE Ø 20,6
				→ 12/02; - ABS; für Linkslenker; nicht für Fahrschulwagen	03.2120-2031.3	010106	ATE Ø 20,6













	kw			 	! #		
RENAULT - MEGANE I (BA0/1_) 08/95→12/04							
 Hauptbremszylinder							
1.9 D Eco	47	01/96→08/03		→ 12/02; + ABS; für Linkslenker	03.2120-4441.3	010510	ATE Ø 20,6
					24.2120-1723.3	010545	BDX Ø 20,6
				→ 12/02; + ABS; für Linkslenker; nicht für Fahrschulwagen	03.2120-4441.3	010510	ATE Ø 20,6
					24.2120-1723.3	010545	BDX Ø 20,6
				06/98→ 12/02; für Rechtslenker	03.2120-4441.3	010510	ATE Ø 20,6
				06/98→ 12/02; - ABS	03.2122-1541.3	010511	Ø 22,2
1.9 dT	76	08/98→10/99		- ABS	03.2120-2031.3	010106	ATE Ø 20,6
					03.2122-1541.3	010511	Ø 22,2
				+ ABS	03.2120-4441.3	010510	ATE Ø 20,6
					24.2120-1723.3	010545	BDX Ø 20,6
				+ ABS; für Linkslenker	03.2120-4441.3	010510	ATE Ø 20,6
					24.2120-1723.3	010545	BDX Ø 20,6
1.9 dT	66	01/96→08/03		+ ABS; für Rechtslenker	24.2120-1725.3	010579	BDX Ø 20,6
				→ 12/02; - ABS	03.2120-2031.3	010106	ATE Ø 20,6
					03.2122-1541.3	010511	Ø 22,2
				03/96→ 12/02; - ABS	03.2120-2031.3	010106	ATE Ø 20,6
				→ 12/02; + ABS; für Linkslenker	03.2120-4441.3	010510	ATE Ø 20,6
					24.2120-1723.3	010545	BDX Ø 20,6
1.9 dTi	72	03/97→02/01		→ 12/02; + ABS	03.2120-4441.3	010510	ATE Ø 20,6
					24.2120-1723.3	010545	BDX Ø 20,6
				+ ABS; für Linkslenker	03.2120-4441.3	010510	ATE Ø 20,6
					24.2120-1723.3	010545	BDX Ø 20,6
				03/99→; + ABS; für Linkslenker	03.2123-2146.3	010572	Ø 23,8
				03/99→; + ABS	03.2123-2146.3	010572	Ø 23,8
				+ ABS; für Rechtslenker	24.2120-1725.3	010579	BDX Ø 20,6
				→ 02/99; + ABS; für Rechtslenker	24.2120-1725.3	010579	BDX Ø 20,6
				→ 12/02; - ABS	03.2120-2031.3	010106	ATE Ø 20,6
					24.2120-1723.3	010545	BDX Ø 20,6
1.9 TDI	69	09/96→08/03		→ 12/02; + ABS	24.2120-1723.3	010545	BDX Ø 20,6
2.0 16V	108	07/96→08/03		→ 12/02	24.2123-1701.3	010424	Ø 23,8
2.0 i	80	03/99→08/03		→ 12/02	03.2120-2031.3	010106	ATE Ø 20,6
2.0 i	84	01/96→08/03		→ 12/02; - ABS	03.2120-2031.3	010106	ATE Ø 20,6
					03.2122-1541.3	010511	Ø 22,2
				→ 12/02; + ABS; für Linkslenker	03.2120-4441.3	010510	ATE Ø 20,6
				24.2120-1723.3	010545	BDX Ø 20,6	
				→ 12/02; + ABS; für Rechtslenker	24.2120-1725.3	010579	BDX Ø 20,6
RENAULT - MEGANE I Cabriolet (EA0/1_) 10/96→08/03							
 Bremskraftverstärker							
1.4 16V	70	03/99→08/03		+ ABS; für Linkslenker	03.7760-5502.4	300151	ATE Ø 10" pneumatisch
				- ABS	03.7760-5602.4	300121	ATE Ø 10" pneumatisch
				10/00→; + ABS; für Linkslenker	03.7863-2002.4	300126	ATE Ø 10" pneumatisch
1.6 16V	79	03/99→07/03		+ ABS; für Linkslenker	03.7760-5102.4	300140	ATE Ø 10" pneumatisch
				10/00→; - ABS	03.7760-5602.4	300121	ATE Ø 10" pneumatisch
				10/00→; + ABS; für Linkslenker	03.7863-2002.4	300126	ATE Ø 10" pneumatisch
2.0 16V	102	01/02→08/03		für Linkslenker	03.7760-5102.4	300140	ATE Ø 10" pneumatisch
2.0 16V IDE	103	11/99→08/03		für Linkslenker	03.7760-5102.4	300140	ATE Ø 10" pneumatisch
				10/00→; - ABS	03.7760-5602.4	300121	ATE Ø 10" pneumatisch
				10/00→; + ABS; für Linkslenker	03.7863-2002.4	300126	ATE Ø 10" pneumatisch
 Hauptbremszylinder							
1.4 16V	70	03/99→08/03		- ABS	03.2122-1541.3	010511	Ø 22,2
				10/00→; + ABS; für Linkslenker	03.2123-2146.3	010572	Ø 23,8
→							

	kw					! #		
RENAULT - MEGANE I Cabriolet (EA0/1_) 10/96→08/03								
 Hauptbremszylinder								
1.6 16V	79	03/99→07/03		10/00→; - ABS		03.2122-1541.3	010511	Ø 22,2
				10/00→; + ABS; für Linkslenker		03.2123-2146.3	010572	Ø 23,8
				+ ABS; für Linkslenker		03.2123-2146.3	010572	Ø 23,8
1.6 e	66	10/96→03/99		- ABS; für Linkslenker		03.2120-2031.3	010106	ATE Ø 20,6
2.0	84	04/97→08/03		+ ABS; für Linkslenker		03.2120-4441.3	010510	ATE Ø 20,6
2.0 i	80	03/99→08/03				24.2120-1723.3	010545	BDX Ø 20,6
				+ ABS; für Rechtslenker		24.2120-1725.3	010579	BDX Ø 20,6
2.0 16V	102	01/02→08/03		für Linkslenker		03.2123-2146.3	010572	Ø 23,8
2.0 16V	108	10/96→11/99				24.2123-1701.3	010424	Ø 23,8
2.0 16V IDE	103	11/99→08/03		10/00→; - ABS		03.2122-1541.3	010511	Ø 22,2
				für Linkslenker		03.2123-2146.3	010572	Ø 23,8
				10/00→; + ABS; für Linkslenker		03.2123-2146.3	010572	Ø 23,8
RENAULT - MEGANE I Classic (LA0/1_) 09/96→08/08								
 Bremskraftverstärker								
1.4	55	09/96→08/03		09/98→ 12/02; + ABS		03.7760-5502.4	300151	ATE Ø 10" pneumatisch
				04/98→ 12/02; + ABS		03.7760-5602.4	300121	ATE Ø 10" pneumatisch
1.4 16V	70	03/99→08/03		→ 12/02; + ABS; für Linkslenker		03.7760-5502.4	300151	ATE Ø 10" pneumatisch
				→ 12/02; - ABS		03.7760-5602.4	300121	ATE Ø 10" pneumatisch
1.6	64	02/00→09/00		+ ABS		03.7760-5502.4	300151	ATE Ø 10" pneumatisch
				- ABS		03.7760-5602.4	300121	ATE Ø 10" pneumatisch
1.6 16V	81	09/99→12/01		+ ABS; für Linkslenker; für Fahrzeuge ohne verstärktes Fahrwerk		03.7760-5102.4	300140	ATE Ø 10" pneumatisch
				+ ABS		03.7760-5502.4	300151	ATE Ø 10" pneumatisch
				+ ABS; für Linkslenker; für Fahrzeuge mit verstärktem Fahrwerk		03.7760-5502.4	300151	ATE Ø 10" pneumatisch
				- ABS		03.7760-5602.4	300121	ATE Ø 10" pneumatisch
				- ABS; für Fahrzeuge mit verstärktem Fahrwerk		03.7760-5602.4	300121	ATE Ø 10" pneumatisch
1.6 16V	79	03/99→07/03		→ 12/02; + ABS; für Linkslenker; für Fahrzeuge ohne verstärktes Fahrwerk		03.7760-5102.4	300140	ATE Ø 10" pneumatisch
				09/99→ 12/02; + ABS		03.7760-5502.4	300151	ATE Ø 10" pneumatisch
				→ 12/02; + ABS; für Linkslenker; für Fahrzeuge mit verstärktem Fahrwerk		03.7760-5502.4	300151	ATE Ø 10" pneumatisch
				→ 12/02; - ABS; für Fahrzeuge mit verstärktem Fahrwerk		03.7760-5602.4	300121	ATE Ø 10" pneumatisch
				09/99→ 12/02; - ABS		03.7760-5602.4	300121	ATE Ø 10" pneumatisch
1.6 e	66	09/96→03/99		+ ABS; für Linkslenker		03.7760-5502.4	300151	ATE Ø 10" pneumatisch
				- ABS; für Linkslenker; für Fahrzeuge mit verstärktem Fahrwerk		03.7760-5602.4	300121	ATE Ø 10" pneumatisch
1.8 16V	85	01/01→08/03		→ 12/02; + ABS; für Linkslenker		03.7863-2002.4	300126	ATE Ø 10" pneumatisch
1.9 D	47	09/96→08/03		09/98→ 12/02; + ABS; für Linkslenker		03.7760-5502.4	300151	ATE Ø 10" pneumatisch
				09/98→ 12/02; - ABS		03.7760-5602.4	300121	ATE Ø 10" pneumatisch
1.9 dCi	75	02/01→08/03		→ 12/02; + ABS; für Linkslenker		03.7760-5102.4	300140	ATE Ø 10" pneumatisch
						03.7863-2002.4	300126	ATE Ø 10" pneumatisch
1.9 dTi	72	03/97→02/01		03/99→; für Linkslenker		03.7760-5102.4	300140	ATE Ø 10" pneumatisch
				03/99→; + ABS; für Linkslenker		03.7760-5502.4	300151	ATE Ø 10" pneumatisch
				- ABS		03.7760-5602.4	300121	ATE Ø 10" pneumatisch
				+ ABS; für Linkslenker		03.7863-2002.4	300126	ATE Ø 10" pneumatisch
1.9 TDI	69	09/96→08/03		→ 12/02; + ABS		03.7760-5502.4	300151	ATE Ø 10" pneumatisch
				→ 12/02; - ABS		03.7760-5602.4	300121	ATE Ø 10" pneumatisch
2.0 i	84	09/96→08/03		09/98→ 12/02; + ABS; für Linkslenker		03.7760-5502.4	300151	ATE Ø 10" pneumatisch
				→ 12/02; - ABS; für Linkslenker		03.7760-5602.4	300121	ATE Ø 10" pneumatisch
2.0 RT	103	03/01→08/03		→ 02/03; - ABS		03.7760-5602.4	300121	ATE Ø 10" pneumatisch
				→ 02/03; + ABS; für Linkslenker		03.7863-2002.4	300126	ATE Ø 10" pneumatisch
 Hauptbremszylinder								
1.4	55	09/96→08/03		→ 12/02; - ABS		03.2120-2031.3	010106	ATE Ø 20,6
				→ 03/99; + ABS		03.2120-4441.3	010510	ATE Ø 20,6
				04/98→ 12/02; - ABS		03.2122-1541.3	010511	Ø 22,2
				09/98→ 02/99; + ABS		24.2120-1723.3	010545	BDX Ø 20,6
				→ 12/02; + ABS		24.2120-1723.3	010545	BDX Ø 20,6
→								











	kw			 	! #		
RENAULT - MEGANE I Classic (LA0/1) 09/96→08/08							
 Hauptbremszylinder							
1.4 16V	70	03/99→08/03	→ 12/02; + ABS; für Rechtslenker	03.2120-4441.3	010510	ATE Ø 20,6	
			→ 12/02; - ABS	03.2122-1541.3	010511	Ø 22,2	
1.6	64	02/00→09/00	- ABS	03.2122-1541.3	010511	Ø 22,2	
1.6 16V	81	09/99→12/01	- ABS	03.2122-1541.3	010511	Ø 22,2	
			- ABS; für Fahrzeuge mit verstärktem Fahrwerk	03.2122-1541.3	010511	Ø 22,2	
			+ ABS; für Linkslenker; für Fahrzeuge ohne verstärktes Fahrwerk	03.2123-2146.3	010572	Ø 23,8	
1.6 16V	79	03/99→07/03	09/99→ 12/02; - ABS	03.2122-1541.3	010511	Ø 22,2	
			→ 12/02; - ABS; für Fahrzeuge mit verstärktem Fahrwerk	03.2122-1541.3	010511	Ø 22,2	
			→ 12/02; + ABS; für Linkslenker; für Fahrzeuge ohne verstärktes Fahrwerk	03.2123-2146.3	010572	Ø 23,8	
1.6 e	66	09/96→03/99	- ABS	03.2120-2031.3	010106	ATE Ø 20,6	
			+ ABS; für Linkslenker	03.2120-4441.3	010510	ATE Ø 20,6	
			+ ABS; für Rechtslenker	24.2120-1723.3	010545	BDX Ø 20,6	
1.6 i	55	09/96→03/99	- ABS	24.2120-1725.3	010579	BDX Ø 20,6	
			+ ABS	03.2120-2031.3	010106	ATE Ø 20,6	
			+ ABS	03.2120-4441.3	010510	ATE Ø 20,6	
1.8 16V	85	01/01→08/03	→ 12/02; + ABS; für Linkslenker	24.2120-1723.3	010545	BDX Ø 20,6	
			→ 12/02; + ABS; für Linkslenker	03.2123-2146.3	010572	Ø 23,8	
			→ 12/02; + ABS; für Rechtslenker	03.2120-2031.3	010106	ATE Ø 20,6	
1.9 D	47	09/96→08/03	→ 12/02; - ABS	03.2120-4441.3	010510	ATE Ø 20,6	
			→ 12/02; + ABS	24.2120-1723.3	010545	BDX Ø 20,6	
			→ 12/02; + ABS; für Linkslenker	03.2120-4441.3	010510	ATE Ø 20,6	
			→ 12/02; + ABS; für Rechtslenker	24.2120-1723.3	010545	BDX Ø 20,6	
			09/98→ 12/02; - ABS	03.2122-1541.3	010511	Ø 22,2	
1.9 dCi	75	02/01→08/03	→ 12/02; + ABS; für Rechtslenker	24.2120-1725.3	010579	BDX Ø 20,6	
			→ 12/02; - ABS	03.2122-1541.3	010511	Ø 22,2	
1.9 dT	76	08/98→10/99	→ 12/02; + ABS; für Linkslenker	03.2123-2146.3	010572	Ø 23,8	
			- ABS	03.2120-2031.3	010106	ATE Ø 20,6	
			+ ABS	03.2120-4441.3	010510	ATE Ø 20,6	
			+ ABS; für Linkslenker	24.2120-1723.3	010545	BDX Ø 20,6	
			+ ABS; für Rechtslenker	03.2120-4441.3	010510	ATE Ø 20,6	
1.9 dT	66	09/96→08/03	+ ABS; für Linkslenker	24.2120-1723.3	010545	BDX Ø 20,6	
			+ ABS; für Rechtslenker	24.2120-1725.3	010579	BDX Ø 20,6	
			→ 12/02; - ABS	03.2120-2031.3	010106	ATE Ø 20,6	
			→ 12/02; + ABS	03.2120-4441.3	010510	ATE Ø 20,6	
			→ 12/02; + ABS; für Linkslenker	24.2120-1723.3	010545	BDX Ø 20,6	
1.9 dTi	72	03/97→02/01	→ 12/02; + ABS; für Rechtslenker	24.2120-1725.3	010579	BDX Ø 20,6	
			- ABS	03.2120-2031.3	010106	ATE Ø 20,6	
			+ ABS; für Linkslenker	03.2120-4441.3	010510	ATE Ø 20,6	
			+ ABS; für Rechtslenker	03.2123-2146.3	010572	Ø 23,8	
			+ ABS; für Linkslenker; für Fahrzeuge ohne verstärktes Fahrwerk	24.2120-1723.3	010545	BDX Ø 20,6	
			+ ABS; für Linkslenker	03.2123-2146.3	010572	Ø 23,8	
			03/99→; - ABS; für Linkslenker	03.2122-1541.3	010511	Ø 22,2	
→ 02/99; + ABS; für Rechtslenker	03.2122-1541.3	010511	Ø 22,2				
1.9 TDI	69	09/96→08/03	→ 12/02; + ABS; für Rechtslenker	24.2120-1725.3	010579	BDX Ø 20,6	
			→ 12/02; - ABS	03.2122-1541.3	010511	Ø 22,2	
2.0 i	84	09/96→08/03	→ 12/02; - ABS	03.2120-2031.3	010106	ATE Ø 20,6	
			→ 12/02	03.2120-2031.3	010106	ATE Ø 20,6	
			→ 12/02; + ABS; für Linkslenker	03.2120-4441.3	010510	ATE Ø 20,6	
			→ 12/02; + ABS; für Rechtslenker	24.2120-1723.3	010545	BDX Ø 20,6	
			03/99→ 12/02; - ABS; für Linkslenker	03.2122-1541.3	010511	Ø 22,2	
2.0 RT	103	03/01→08/03	→ 12/02; + ABS; für Rechtslenker	24.2120-1725.3	010579	BDX Ø 20,6	
			→ 02/03; - ABS	03.2122-1541.3	010511	Ø 22,2	
2.0 RT	112	10/96→02/99	→ 02/03; + ABS; für Linkslenker	03.2123-2146.3	010572	Ø 23,8	
			+ ABS; für Linkslenker	03.2120-2031.3	010106	ATE Ø 20,6	













	kw					! #		
RENAULT - MEGANE I Coach (DA0/1_) 03/96→08/03								
 Bremskraftverstärker								
1.4 16V	70	03/99→07/03		→ 02/03; + ABS; für Linkslenker		03.7760-5502.4	300151	ATE Ø 10" pneumatisch
				→ 02/03; - ABS		03.7760-5602.4	300121	ATE Ø 10" pneumatisch
				10/00→ 02/03; + ABS; für Linkslenker		03.7863-2002.4	300126	ATE Ø 10" pneumatisch
1.6 16V	79	03/99→07/03		→ 02/03; + ABS; für Linkslenker		03.7760-5102.4	300140	ATE Ø 10" pneumatisch
				10/00→ 02/03; - ABS		03.7760-5602.4	300121	ATE Ø 10" pneumatisch
				10/00→ 02/03; + ABS; für Linkslenker		03.7863-2002.4	300126	ATE Ø 10" pneumatisch
1.9 dCi	75	02/01→08/03		→ 02/03; + ABS; für Linkslenker		03.7760-5102.4	300140	ATE Ø 10" pneumatisch
						03.7863-2002.4	300126	ATE Ø 10" pneumatisch
1.9 dTi	72	03/97→02/01		03/99→; für Linkslenker		03.7760-5102.4	300140	ATE Ø 10" pneumatisch
2.0 16V	108	03/96→11/99						
2.0 16V	102	01/02→08/03		→ 02/03; für Linkslenker		03.7760-5102.4	300140	ATE Ø 10" pneumatisch
				→ 02/03; - ABS		03.7760-5602.4	300121	ATE Ø 10" pneumatisch
				→ 02/03; + ABS; für Linkslenker		03.7863-2002.4	300126	ATE Ø 10" pneumatisch
2.0 16V IDE	103	11/99→08/03		→ 02/03; für Linkslenker		03.7760-5102.4	300140	ATE Ø 10" pneumatisch
				10/00→ 02/03; - ABS		03.7760-5602.4	300121	ATE Ø 10" pneumatisch
				10/00→ 02/03; + ABS; für Linkslenker		03.7863-2002.4	300126	ATE Ø 10" pneumatisch
 Hauptbremszylinder								
1.4 16V	70	03/99→07/03		→ 02/03; für Rechtslenker		03.2120-4441.3	010510	ATE Ø 20,6
				→ 02/03; - ABS		03.2122-1541.3	010511	Ø 22,2
				10/00→ 02/03; + ABS; für Linkslenker		03.2123-2146.3	010572	Ø 23,8
1.6 16V	79	03/99→07/03		10/00→ 02/03; - ABS		03.2122-1541.3	010511	Ø 22,2
				10/00→ 02/03; + ABS; für Linkslenker		03.2123-2146.3	010572	Ø 23,8
				→ 02/03; + ABS; für Linkslenker		03.2123-2146.3	010572	Ø 23,8
1.6 e	66	03/96→03/99		- ABS; für Linkslenker		03.2120-2031.3	010106	ATE Ø 20,6
				+ ABS		03.2120-4441.3	010510	ATE Ø 20,6
				+ ABS; für Linkslenker		24.2120-1723.3	010545	BDX Ø 20,6
				+ ABS; für Rechtslenker		24.2120-1725.3	010579	BDX Ø 20,6
1.9 dCi	75	02/01→08/03		→ 02/03; - ABS		03.2122-1541.3	010511	Ø 22,2
2.0 16V	102	01/02→08/03		→ 02/03; + ABS; für Linkslenker		03.2123-2146.3	010572	Ø 23,8
1.9 dTi	72	03/97→02/01		05/97→; - ABS		03.2120-2031.3	010106	ATE Ø 20,6
				05/97→ 02/99; + ABS		03.2120-4441.3	010510	ATE Ø 20,6
						24.2120-1723.3	010545	BDX Ø 20,6
				03/99→; + ABS		03.2123-2146.3	010572	Ø 23,8
2.0 16V	108	03/96→11/99		03/99→; für Linkslenker		03.2123-2146.3	010572	Ø 23,8
				→ 02/99		24.2123-1701.3	010424	Ø 23,8
2.0 16V IDE	103	11/99→08/03		10/00→ 02/03; - ABS		03.2122-1541.3	010511	Ø 22,2
				→ 02/03; für Linkslenker		03.2123-2146.3	010572	Ø 23,8
				10/00→ 02/03; + ABS; für Linkslenker		03.2123-2146.3	010572	Ø 23,8
2.0 i	80 - 84	03/96→08/03		→ 02/03; - ABS; für Linkslenker		03.2120-2031.3	010106	ATE Ø 20,6
				→ 02/03; + ABS		03.2120-4441.3	010510	ATE Ø 20,6
				→ 02/03; + ABS; für Linkslenker		24.2120-1723.3	010545	BDX Ø 20,6
				→ 02/03; + ABS; für Rechtslenker		24.2120-1725.3	010579	BDX Ø 20,6
RENAULT - MEGANE I Grandtour (KA0/1_) 03/99→08/03								
 Bremskraftverstärker								
1.4 16V	70	03/99→08/03		+ ABS; für Fahrzeuge mit verstärktem Fahrwerk		03.7760-5502.4	300151	ATE Ø 10" pneumatisch
				- ABS		03.7760-5602.4	300121	ATE Ø 10" pneumatisch
				+ ABS; für Linkslenker		03.7863-2002.4	300126	ATE Ø 10" pneumatisch
1.4 e	55	03/99→08/03		+ ABS; für Fahrzeuge mit verstärktem Fahrwerk		03.7760-5502.4	300151	ATE Ø 10" pneumatisch
1.6 e	66	03/99→08/03						
1.9 D	47	04/99→08/03		- ABS		03.7760-5602.4	300121	ATE Ø 10" pneumatisch
1.6 16V	79	03/99→08/03		+ ABS; für Linkslenker; für Fahrzeuge ohne verstärktes Fahrwerk		03.7760-5102.4	300140	ATE Ø 10" pneumatisch
				- ABS		03.7760-5602.4	300121	ATE Ø 10" pneumatisch
				+ ABS; für Linkslenker		03.7863-2002.4	300126	ATE Ø 10" pneumatisch
1.6 Bifuel	80	03/99→09/00		- ABS		03.7760-5602.4	300121	ATE Ø 10" pneumatisch
1.8 16V	85	01/01→08/03		+ ABS; für Linkslenker		03.7863-2002.4	300126	ATE Ø 10" pneumatisch
1.9 dCi	75	02/01→08/03		+ ABS; für Linkslenker; für Fahrzeuge ohne verstärktes Fahrwerk		03.7760-5102.4	300140	ATE Ø 10" pneumatisch
				+ ABS; für Linkslenker		03.7863-2002.4	300126	ATE Ø 10" pneumatisch
→								













	kw					! #		
RENAULT - MEGANE I Grandtour (KA0/1_) 03/99→08/03								
 Bremskraftverstärker								
1.9 dTi	72	03/99→02/01		+ ABS; für Linkslenker; für Fahrzeuge ohne verstärktes Fahrwerk		03.7760-5102.4	300140	ATE Ø 10" pneumatisch
				- ABS		03.7760-5602.4	300121	ATE Ø 10" pneumatisch
1.9 dTi	59	02/01→08/03		- ABS		03.7760-5602.4	300121	ATE Ø 10" pneumatisch
				+ ABS; für Linkslenker		03.7863-2002.4	300126	ATE Ø 10" pneumatisch
 Hauptbremszylinder								
1.4 16V	70	03/99→08/03		- ABS		03.2122-1541.3	010511	Ø 22,2
1.4 e	55	03/99→08/03						
1.6 e	66	03/99→08/03						
1.9 D	47	04/99→08/03						
1.6 16V	79	03/99→08/03		- ABS		03.2123-1551.3	010512	Ø 23,8
1.6 Bifuel	80	03/99→09/00		+ ABS		03.2123-2146.3	010572	Ø 23,8
1.9 dCi	75	02/01→08/03						
1.9 dTi	72	03/99→02/01						
1.8 16V	85	01/01→08/03		+ ABS		03.2123-2146.3	010572	Ø 23,8
						03.2123-2621.3	010701	ATE Ø 23,8
1.9 dTi	59	02/01→08/03		- ABS		03.2123-2146.3	010572	Ø 23,8
				+ ABS		03.2123-2621.3	010701	ATE Ø 23,8
RENAULT - MEGANE I Hatchback Van (SA0/1_) 08/95→07/03								
 Bremskraftverstärker								
1.9	47	08/95→09/00		06/98→; + ABS; für Linkslenker		03.7760-5502.4	300151	ATE Ø 10" pneumatisch
				06/98→; - ABS		03.7760-5602.4	300121	ATE Ø 10" pneumatisch
1.9 dCi	59	10/00→07/03		+ ABS; für Linkslenker		03.7863-2002.4	300126	ATE Ø 10" pneumatisch
 Hauptbremszylinder								
1.9	47	08/95→09/00		- ABS; für Rechtslenker		03.2120-2031.3	010106	ATE Ø 20,6
				- ABS		03.2120-2031.3	010106	ATE Ø 20,6
				- ABS; für Linkslenker; nicht für Fahrschulwagen		03.2120-2031.3	010106	ATE Ø 20,6
				06/98→; für Rechtslenker		03.2120-4441.3	010510	ATE Ø 20,6
				+ ABS; für Linkslenker; nicht für Fahrschulwagen		03.2120-4441.3	010510	ATE Ø 20,6
						24.2120-1723.3	010545	BDX Ø 20,6
				+ ABS; für Linkslenker		03.2120-4441.3	010510	ATE Ø 20,6
						24.2120-1723.3	010545	BDX Ø 20,6
				06/98→; - ABS		03.2122-1541.3	010511	Ø 22,2
				+ ABS; für Rechtslenker		24.2120-1725.3	010579	BDX Ø 20,6
				→ 03/99; + ABS; für Rechtslenker		24.2120-1725.3	010579	BDX Ø 20,6
1.9 dCi	59	10/00→07/03		+ ABS; für Linkslenker		03.2123-2146.3	010572	Ø 23,8
RENAULT - Megane I Kombi van (KA_) 02/00→07/03								
 Bremskraftverstärker								
1.4	70	04/01→07/03		+ ABS; für Fahrzeuge mit verstärktem Fahrwerk		03.7760-5502.4	300151	ATE Ø 10" pneumatisch
				- ABS		03.7760-5602.4	300121	ATE Ø 10" pneumatisch
				+ ABS; für Linkslenker		03.7863-2002.4	300126	ATE Ø 10" pneumatisch
1.6	79	04/01→07/03		+ ABS; für Linkslenker; für Fahrzeuge ohne verstärktes Fahrwerk		03.7760-5102.4	300140	ATE Ø 10" pneumatisch
1.6 BiFuel	79 - 80	04/01→07/03		- ABS		03.7760-5602.4	300121	ATE Ø 10" pneumatisch
				+ ABS; für Linkslenker		03.7863-2002.4	300126	ATE Ø 10" pneumatisch
1.8	85	04/01→07/03		+ ABS; für Linkslenker		03.7863-2002.4	300126	ATE Ø 10" pneumatisch
1.9 D	47	02/00→09/00		+ ABS; für Fahrzeuge mit verstärktem Fahrwerk		03.7760-5502.4	300151	ATE Ø 10" pneumatisch
				- ABS		03.7760-5602.4	300121	ATE Ø 10" pneumatisch
1.9 dCi	75 - 77	04/01→07/03		+ ABS; für Linkslenker; für Fahrzeuge ohne verstärktes Fahrwerk		03.7760-5102.4	300140	ATE Ø 10" pneumatisch
				+ ABS; für Linkslenker		03.7863-2002.4	300126	ATE Ø 10" pneumatisch
1.9 DTI	59	04/01→07/03		- ABS		03.7760-5602.4	300121	ATE Ø 10" pneumatisch
				+ ABS; für Linkslenker		03.7863-2002.4	300126	ATE Ø 10" pneumatisch
 Hauptbremszylinder								
1.4	70	04/01→07/03		- ABS		03.2122-1541.3	010511	Ø 22,2
1.9 D	47	02/00→09/00						
1.6	79	04/01→07/03		- ABS		03.2123-1551.3	010512	Ø 23,8
1.6 BiFuel	79 - 80	04/01→07/03		+ ABS		03.2123-2146.3	010572	Ø 23,8



























	kw			 	! #		
RENAULT - Megane I Kombi van (KA_) 02/00→07/03							
 Hauptbremszylinder							
1.9 dCi	75 - 77	04/01→07/03		- ABS		03.2123-1551.3 010512	Ø 23,8
				+ ABS		03.2123-2146.3 010572	Ø 23,8
1.8	85	04/01→07/03		+ ABS		03.2123-2146.3 010572	Ø 23,8
						03.2123-2621.3 010701	ATE Ø 23,8
1.9 DTI	59	04/01→07/03		- ABS		03.2123-2146.3 010572	Ø 23,8
				+ ABS		03.2123-2621.3 010701	ATE Ø 23,8
RENAULT - MEGANE II (BM0/1_, CM0/1_) 07/01→10/12							
 Hauptbremszylinder							
1.4 16V	60 - 72	11/02→02/08				24.2123-1760.3 010779	TRW Ø 23,8
1.5 dCi	63 - 78	10/03→06/08				24.4123-1721.3 011052	BOS Ø 23,8 ohne Bremsflüssigkeitsbehälter
1.6	77 - 79	06/05→01/11					
1.6 16V	82 - 83	11/02→06/08					
1.6 Flex-Fuel	77	01/07→02/08					
1.9 dCi	88	11/02→02/08					
2.0	169	08/06→02/08					
2.0 16V	99	11/02→02/08					
2.0 16V Turbo	120	05/04→02/08					
2.0 dCi	110 - 127	09/05→02/08					
1.5 dCi	60	09/02→02/08		11/02→		24.2123-1760.3 010779	TRW Ø 23,8
						24.4123-1721.3 011052	BOS Ø 23,8 ohne Bremsflüssigkeitsbehälter
1.5 dCi	76	01/07→03/09		→ 11/08		24.2123-1760.3 010779	TRW Ø 23,8
1.9 dCi	96	05/05→12/09				24.4123-1721.3 011052	BOS Ø 23,8 ohne Bremsflüssigkeitsbehälter
2.0 Renault Sport	165	05/04→10/09					
1.6 Bifuel	77	06/05→02/08		01/07→		24.2123-1760.3 010779	TRW Ø 23,8
						24.4123-1721.3 011052	BOS Ø 23,8 ohne Bremsflüssigkeitsbehälter
1.9 dCi	66	11/02→12/05				24.4123-1721.3 011052	BOS Ø 23,8 ohne Bremsflüssigkeitsbehälter
1.9 dCi	68 - 85	11/02→02/08		01/06→		24.2123-1760.3 010779	TRW Ø 23,8
						24.4123-1721.3 011052	BOS Ø 23,8 ohne Bremsflüssigkeitsbehälter
RENAULT - MEGANE II Coupé-Cabriolet (EM0/1_) 09/03→03/10							
 Hauptbremszylinder							
1.5 dCi	76	01/07→06/09				24.2123-1760.3 010779	TRW Ø 23,8
1.6	77 - 83	09/03→03/09				24.4123-1721.3 011052	BOS Ø 23,8 ohne Bremsflüssigkeitsbehälter
1.9 dCi	81 - 96	09/03→03/09					
2.0	102	09/03→02/07					
2.0 16V Turbo	120	05/04→03/09					
2.0 dCi	110	09/05→03/09					
1.5 dCi	78	03/06→01/09		→ 06/08		24.2123-1760.3 010779	TRW Ø 23,8
						24.4123-1721.3 011052	BOS Ø 23,8 ohne Bremsflüssigkeitsbehälter
1.6 16V	82	01/06→06/08		01/07→		24.2123-1760.3 010779	TRW Ø 23,8
						24.4123-1721.3 011052	BOS Ø 23,8 ohne Bremsflüssigkeitsbehälter
1.9 dCi	85	09/03→03/09		01/06→		24.2123-1760.3 010779	TRW Ø 23,8
						24.4123-1721.3 011052	BOS Ø 23,8 ohne Bremsflüssigkeitsbehälter
2.0	99	09/03→12/09		→ 03/07		24.2123-1760.3 010779	TRW Ø 23,8
						24.4123-1721.3 011052	BOS Ø 23,8 ohne Bremsflüssigkeitsbehälter
RENAULT - MEGANE II Hatchback Van (KM0/2_) 08/03→07/09							
 Hauptbremszylinder							
1.5 dCi	60 - 78	08/03→03/09				24.2123-1760.3 010779	TRW Ø 23,8
						24.4123-1721.3 011052	BOS Ø 23,8 ohne Bremsflüssigkeitsbehälter











	kw			 	! #		
RENAULT - MEGANE II Kasten/Kombi (KM_) 08/03→07/09							
 Hauptbremszylinder							
1.5 dCi	60	08/03→07/09				24.2123-1760.3 010779	TRW Ø 23,8
1.6	78	08/03→07/09				24.4123-1721.3 011052	BOS Ø 23,8 ohne Bremsflüssigkeitsbehälter
1.9 dCi	82	10/03→01/08					
	96	02/06→10/06					
RENAULT - MEGANE II Kombi (KM0/1_) 08/03→08/12							
 Hauptbremszylinder							
1.4	72	08/03→07/09		09/03→ 12/08		24.2123-1760.3 010779	TRW Ø 23,8
1.6	83	08/03→07/09				24.4123-1721.3 011052	BOS Ø 23,8 ohne Bremsflüssigkeitsbehälter
1.9 dCi	88	08/03→07/09					
2.0	99	08/03→07/09					
1.5 dCi	63 - 78	02/04→07/09				24.2123-1760.3 010779	TRW Ø 23,8
1.6 16V	75 - 77	05/05→07/09				24.4123-1721.3 011052	BOS Ø 23,8 ohne Bremsflüssigkeitsbehälter
1.6 LPG 16V	82	01/06→08/09					
1.9 dCi	66 - 68	03/04→02/07					
2.0	102	12/06→01/11					
1.5 dCi	60	08/03→05/06		09/03→		24.2123-1760.3 010779	TRW Ø 23,8
						24.4123-1721.3 011052	BOS Ø 23,8 ohne Bremsflüssigkeitsbehälter
1.5 dCi	76	01/07→07/09		→ 12/08		24.2123-1760.3 010779	TRW Ø 23,8
1.6 16V Hi-Flex	77	02/08→07/09				24.4123-1721.3 011052	BOS Ø 23,8 ohne Bremsflüssigkeitsbehälter
1.9 dCi	81 - 85	05/05→07/09					
2.0 dCi	110	09/05→07/09					
1.6 16V	81	05/06→10/11		→ 07/09		24.2123-1760.3 010779	TRW Ø 23,8
						24.4123-1721.3 011052	BOS Ø 23,8 ohne Bremsflüssigkeitsbehälter
1.6 16V	82	01/06→08/09		01/07→ 12/08		24.2123-1760.3 010779	TRW Ø 23,8
						24.4123-1721.3 011052	BOS Ø 23,8 ohne Bremsflüssigkeitsbehälter
1.9 dCi	96	05/05→07/09		→ 02/07		24.2123-1760.3 010779	TRW Ø 23,8
						24.4123-1721.3 011052	BOS Ø 23,8 ohne Bremsflüssigkeitsbehälter
RENAULT - MEGANE II Stufenheck (LM0/1_) 08/03→							
 Hauptbremszylinder							
1.4	60	09/03→		→ 08/06		24.2123-1760.3 010779	TRW Ø 23,8
						24.4123-1721.3 011052	BOS Ø 23,8 ohne Bremsflüssigkeitsbehälter
1.4	72	09/03→		→ 12/08		24.2123-1760.3 010779	TRW Ø 23,8
1.5 dCi	78	05/05→12/10				24.4123-1721.3 011052	BOS Ø 23,8 ohne Bremsflüssigkeitsbehälter
1.6	77 - 83	09/03→					
1.6 Hi-Flex	85	03/06→					
1.9 dCi	81 - 96	09/03→					
2.0 dCi	110	09/05→					
1.5 dCi	74	02/04→12/10		→ 03/06; für Fahrzeuge ohne Sportfahrwerk		24.2123-1760.3 010779	TRW Ø 23,8
				→ 03/06; für Fahrzeuge mit Sportfahrwerk		24.2125-1742.3 010978	TRW Ø 25,4
				→ 03/06		24.4123-1721.3 011052	BOS Ø 23,8 ohne Bremsflüssigkeitsbehälter
1.5 dCi	60	08/03→12/10		09/03→ 12/08		24.2123-1760.3 010779	TRW Ø 23,8
						24.4123-1721.3 011052	BOS Ø 23,8 ohne Bremsflüssigkeitsbehälter
1.5 dCi	76	10/03→12/10		01/07→; für Fahrzeuge ohne Sportfahrwerk; → 12/08		24.2123-1760.3 010779	TRW Ø 23,8
				01/07→; für Fahrzeuge mit Sportfahrwerk; → 12/08		24.2125-1742.3 010978	TRW Ø 25,4
				01/07→ 12/08		24.4123-1721.3 011052	BOS Ø 23,8 ohne Bremsflüssigkeitsbehälter
1.5 dCi	63	05/05→12/10		für Fahrzeuge ohne Sportfahrwerk; → 12/08		24.2123-1760.3 010779	TRW Ø 23,8
1.9 dCi	68	03/04→				24.2125-1742.3 010978	TRW Ø 25,4
2.0	99	09/03→		für Fahrzeuge mit Sportfahrwerk; → 12/08		24.4123-1721.3 011052	BOS Ø 23,8 ohne Bremsflüssigkeitsbehälter
				→ 12/08			
1.6	81	09/03→11/08				24.2123-1760.3 010779	TRW Ø 23,8
2.0	101	04/06→11/10					
→							





























	kw			 	! #		
RENAULT - MEGANE II Stufenheck (LM0/1_) 08/03→							
 Hauptbremszylinder							
1.6 2.0	81 101	09/03→11/08 04/06→11/10				24.4123-1721.3 011052	BOS Ø 23,8 ohne Bremsflüssigkeitsbehälter
1.6 16V	82	01/06→		01/07→ 12/08		24.2123-1760.3 010779 24.4123-1721.3 011052	TRW Ø 23,8 BOS Ø 23,8 ohne Bremsflüssigkeitsbehälter
1.9 dCi	66	09/03→12/05		für Fahrzeuge ohne Sportfahrwerk		24.2123-1760.3 010779	TRW Ø 23,8
				für Fahrzeuge mit Sportfahrwerk		24.2125-1742.3 010978	TRW Ø 25,4
						24.4123-1721.3 011052	BOS Ø 23,8 ohne Bremsflüssigkeitsbehälter
RENAULT - MEGANE III Combi Van (KZ0/1) 01/09→08/15							
 Hauptbremszylinder							
1.5 dCi	63 - 81	01/09→08/15				24.4123-1715.3 010980	TRW Ø 23,8
RENAULT - MEGANE III Coupe (DZ0/1_) 11/08→09/16							
 Hauptbremszylinder							
1.2 TCe 1.4 TCe 1.5 dCi 1.6 16V 1.6 16V Bifuel 1.6 dCi 1.9 dCi 2.0 CVT 2.0 dCi 2.0 TCe	85 - 97 96 63 - 81 74 - 81 81 96 96 103 110 - 120 132 - 184	03/12→08/15 04/09→08/15 11/08→08/15 11/08→08/15 11/08→08/15 04/11→08/15 11/08→08/15 05/09→08/15 04/09→08/15 11/08→08/15				24.4123-1715.3 010980	TRW Ø 23,8
RENAULT - MEGANE III Grandtour (KZ0/1) 11/08→01/16							
 Hauptbremszylinder							
1.2 TCe 1.4 TCe 1.5 dCi 1.6 16V 1.6 BiFuel 1.6 dCi 1.9 dCi 2.0 CVT 2.0 dCi 2.0 TCe	85 - 97 96 63 - 81 74 - 81 81 96 96 103 110 - 120 140 - 162	03/12→01/16 05/09→08/15 02/09→08/15 05/09→08/15 11/08→08/15 04/11→08/15 05/09→08/15 05/09→08/15 04/09→08/15 09/12→01/16				24.4123-1715.3 010980	TRW Ø 23,8
2.0 TCe	132	11/08→08/15		05/09→		24.4123-1715.3 010980	TRW Ø 23,8
RENAULT - MEGANE III Hatchback Van (BZ_) 11/08→08/15							
 Hauptbremszylinder							
1.5 dCi	66 - 81	11/08→08/15				24.4123-1715.3 010980	TRW Ø 23,8
RENAULT - MEGANE III Schrägheck (BZ0/1_, B3_) 11/08→							
 Hauptbremszylinder							
1.2 TCe 1.4 TCe 1.5 dCi 1.6 1.6 16V 1.6 16V BiFuel 1.6 16V Hi-Flex 1.6 dCi 1.9 dCi 2.0 2.0 CVT 2.0 dCi 2.0 TCe	85 - 97 96 63 - 81 86 74 - 85 81 81 96 96 105 103 110 - 120 132	03/12→01/16 04/09→08/15 11/08→01/16 01/14→01/16 11/08→01/16 05/09→08/15 11/08→08/15 04/11→08/15 11/08→01/16 01/11→08/15 02/09→08/15 04/09→08/15 11/08→08/15				24.4123-1715.3 010980	TRW Ø 23,8















	kw					! #			
RENAULT - MEGANE CC (EZ0/1_) 06/10→08/15									
 Hauptbremszylinder									
1.2 TCe	85	09/12→08/15					24.4123-1715.3	010980	TRW Ø 23,8
1.4 TCe	96	06/10→08/15							
1.5 dCi	78 - 81	06/10→08/15							
1.6 16V	81	06/10→08/15							
1.6 16V Hi-Flex	81	06/10→08/15							
1.6 dCi	96	04/11→08/15							
1.9 dCi	96	06/10→08/15							
2.0 CVT	103	06/10→08/15							
2.0 dCi	118	06/10→08/15							
2.0 TCe	132	06/10→08/15							
1.2 TCe	97	01/13→08/15		04/13→			24.4123-1715.3	010980	TRW Ø 23,8
RENAULT - MEGANE Scenic (JA0/1_) 10/96→12/01									
 Bremskraftverstärker									
1.4 i	55	01/97→09/99		10/98→			03.7760-5102.4	300140	ATE Ø 10" pneumatisch
1.6 i	55	01/97→09/99							
1.6 16V	79	04/98→10/99		10/98→ 09/99; für Linkslenker			03.7760-5102.4	300140	ATE Ø 10" pneumatisch
1.6 e	66	10/96→10/99							
2.0 RXE 4x4	84	05/97→10/99							
1.9 D	47	03/97→09/99		10/98→; für Linkslenker			03.7760-5102.4	300140	ATE Ø 10" pneumatisch
1.9 dTi	72	04/97→09/99		10/98→			03.7760-5102.4	300140	ATE Ø 10" pneumatisch
2.0 i	80	01/99→09/99		für Linkslenker			03.7760-5102.4	300140	ATE Ø 10" pneumatisch
2.0 i	84	01/97→09/99		10/98→; für Linkslenker			03.7760-5102.4	300140	ATE Ø 10" pneumatisch
 Hauptbremszylinder									
1.4 i	55	01/97→09/99		→ 09/98; - ABS			03.2120-2031.3	010106	ATE Ø 20,6
1.6 i	55	01/97→09/99		10/98→; - ABS			03.2123-1551.3	010512	Ø 23,8
				10/98→; + ABS			03.2123-2146.3	010572	Ø 23,8
				→ 09/98; + ABS			24.2120-1723.3	010545	BDX Ø 20,6
1.6 16V	79	04/98→10/99		10/98→ 09/99; - ABS; für Linkslenker			03.2123-1551.3	010512	Ø 23,8
2.0 RXE 4x4	84	05/97→10/99		10/98→ 09/99; + ABS; für Linkslenker			03.2123-2146.3	010572	Ø 23,8
1.6 e	66	10/96→10/99		11/96→ 09/98; - ABS; Schaltgetriebe			03.2120-2031.3	010106	ATE Ø 20,6
				10/98→ 09/99; - ABS; für Linkslenker			03.2123-1551.3	010512	Ø 23,8
				10/98→ 09/99; + ABS; für Linkslenker			03.2123-2146.3	010572	Ø 23,8
				11/96→ 09/98; + ABS; für Linkslenker; Schaltgetriebe			24.2120-1723.3	010545	BDX Ø 20,6
				11/96→ 09/98; + ABS; für Rechtslenker; Schaltgetriebe			24.2120-1725.3	010579	BDX Ø 20,6
1.9 D	47	03/97→09/99		10/98→; - ABS			03.2123-1551.3	010512	Ø 23,8
1.9 dTi	72	04/97→09/99		10/98→; - ABS; für Linkslenker			03.2123-1551.3	010512	Ø 23,8
				10/98→; + ABS			03.2123-2146.3	010572	Ø 23,8
				10/98→; + ABS; für Linkslenker			03.2123-2146.3	010572	Ø 23,8
2.0 i	80	01/99→09/99		- ABS; für Linkslenker			03.2123-1551.3	010512	Ø 23,8
				+ ABS; für Linkslenker			03.2123-2146.3	010572	Ø 23,8
2.0 i	84	01/97→09/99		10/98→; - ABS; für Linkslenker			03.2123-1551.3	010512	Ø 23,8
				10/98→; + ABS; für Linkslenker			03.2123-2146.3	010572	Ø 23,8
RENAULT - MODUS / GRAND MODUS (F/JP0_) 09/04→									
 Bremskraftverstärker									
1.2	76	04/11→		→ 06/13			03.7863-1232.4	300314	ATE Ø 10" pneumatisch
1.2 16V Hi-Flex	55	10/08→							
1.5 dCi 75	55	10/10→							
1.5 dCi 90	65	10/10→							
1.2	48 - 58	12/04→		für Linkslenker; → 06/13; + ABS			03.7863-4502.4	300230	ATE Ø 10" pneumatisch
1.2 16V	74	05/07→							
1.2	55	12/04→		→ 01/05; für Linkslenker			03.7863-1232.4	300314	ATE Ø 10" pneumatisch
				für Linkslenker; → 06/13; + ABS			03.7863-4502.4	300230	ATE Ø 10" pneumatisch
1.2 GPL	55	05/08→12/12					03.7863-1232.4	300314	ATE Ø 10" pneumatisch
1.4	72	12/04→		→ 01/05; für Linkslenker			03.7863-1232.4	300314	ATE Ø 10" pneumatisch
				02/05→; für Linkslenker; → 10/07; + ABS			03.7863-4502.4	300230	ATE Ø 10" pneumatisch
1.5 dCi	50 - 63	09/04→		→ 01/05; für Linkslenker			03.7863-1232.4	300314	ATE Ø 10" pneumatisch
1.6	65 - 82	12/04→		02/05→; für Linkslenker; → 06/13; + ABS			03.7863-4502.4	300230	ATE Ø 10" pneumatisch
1.5 dCi	48	12/04→		02/05→; für Linkslenker; → 06/13; + ABS			03.7863-4502.4	300230	ATE Ø 10" pneumatisch
1.5 dCi	76	05/07→		11/07→ 06/13			03.7863-1232.4	300314	ATE Ø 10" pneumatisch
→									













	kw					! #		
RENAULT - MODUS / GRAND MODUS (F/JP0_) 09/04 →								
 Bremskraftverstärker								
1.5 dCi	76	05/07 →			→ 10/07; für Linkslenker; + ABS		03.7863-4502.4 300230	ATE Ø 10" pneumatisch
 Hauptbremszylinder								
1.2	48 - 76	12/04 →			für Linkslenker; → 06/13; - ESP		03.2123-3241.3 010882	ATE Ø 23,8
1.5 dCi 75	55	10/10 →			für Linkslenker; → 06/13; + ESP		03.2123-3493.3 010792	ATE Ø 23,8
1.5 dCi 90	65	10/10 →						
1.2	55	12/04 →			für Linkslenker; → 06/13; - ABS		03.2123-2821.3 010944	ATE Ø 23,8
1.4	72	12/04 →			für Linkslenker; → 01/05; + ABS / - ESP		03.2123-2863.3 010790	ATE Ø 23,8
1.5 dCi	50 - 63	12/04 →			für Linkslenker; → 01/05; + ESP		03.2123-2923.3 010791	ATE Ø 23,8
					02/05 →; für Linkslenker; → 06/13; - ESP		03.2123-3241.3 010882	ATE Ø 23,8
					02/05 →; für Linkslenker; → 06/13; + ESP		03.2123-3493.3 010792	ATE Ø 23,8
1.2 16V	74	05/07 →			für Linkslenker; → 06/13; - ABS		03.2123-2821.3 010944	ATE Ø 23,8
1.5 dCi	76	05/07 →			für Linkslenker; → 06/13; - ESP		03.2123-3241.3 010882	ATE Ø 23,8
					für Linkslenker; → 06/13; + ESP		03.2123-3493.3 010792	ATE Ø 23,8
1.2 16V Hi-Flex	55	10/08 →			für Linkslenker; → 06/13; - ABS		03.2123-2821.3 010944	ATE Ø 23,8
1.2 GPL	55	05/08 → 12/12			für Linkslenker; - ABS		03.2123-2821.3 010944	ATE Ø 23,8
1.5 dCi	60	09/04 →			09/05 →; für Linkslenker; → 06/13; - ABS		03.2123-2821.3 010944	ATE Ø 23,8
					für Linkslenker; → 01/05; + ABS / - ESP		03.2123-2863.3 010790	ATE Ø 23,8
					für Linkslenker; → 01/05; + ESP		03.2123-2923.3 010791	ATE Ø 23,8
					02/05 →; für Linkslenker; → 06/13; - ESP		03.2123-3241.3 010882	ATE Ø 23,8
					02/05 →; für Linkslenker; → 06/13; + ESP		03.2123-3493.3 010792	ATE Ø 23,8
1.5 dCi	48	12/04 →			02/05 →; für Linkslenker; → 06/13; - ESP		03.2123-3241.3 010882	ATE Ø 23,8
					02/05 →; für Linkslenker; → 06/13; + ESP		03.2123-3493.3 010792	ATE Ø 23,8
1.5 dCi	78	05/05 →			05/07 →; für Linkslenker; → 06/13; - ESP		03.2123-3241.3 010882	ATE Ø 23,8
					05/07 →; für Linkslenker; → 06/13; + ESP		03.2123-3493.3 010792	ATE Ø 23,8
1.6	65 - 82	12/04 →			für Linkslenker; → 06/13; - ABS		03.2123-2821.3 010944	ATE Ø 23,8
					für Linkslenker; → 01/05; + ABS / - ESP		03.2123-2863.3 010790	ATE Ø 23,8
					für Linkslenker; → 01/05; + ESP		03.2123-2923.3 010791	ATE Ø 23,8
					für Linkslenker; → 06/13; - ESP		03.2123-3241.3 010882	ATE Ø 23,8
					für Linkslenker; → 06/13; + ESP		03.2123-3493.3 010792	ATE Ø 23,8
RENAULT - SAFRANE II (B54_) 07/96 → 12/00								
 Hauptbremszylinder								
2.0 16V	100	07/96 → 12/00			08/96 →; für Rechtslenker		24.2122-1707.3 010438	Ø 22,2
					08/96 →; für Linkslenker		24.2123-1701.3 010424	Ø 23,8
2.2 dT	83	07/96 → 12/00			08/96 →		24.2123-1701.3 010424	Ø 23,8
2.5 20V	121	07/96 → 12/00						
2.9 24V	140	03/99 → 12/00					24.2123-1701.3 010424	Ø 23,8
3.0 V6	123	07/96 → 12/00			→ 07/96		24.2123-1701.3 010424	Ø 23,8
					10/96 →		24.2123-1701.3 010424	Ø 23,8
RENAULT - SANDERO/STEPWAY I (BS_) 11/07 →								
 Bremskraftverstärker								
1.4	55	02/09 →			+ ABS		03.7853-4602.4 300302	ATE Ø 9" pneumatisch
1.4 LPG	53	02/09 →						
1.6	62 - 82	12/07 →						
1.6 Flex	82	08/08 →						
 Hauptbremszylinder								
1.4	55	02/09 →			+ ABS		03.2120-4611.3 010937	ATE Ø 20,6
1.4 LPG	53	02/09 →			- ABS		24.2120-1762.3 011002	Ø 20,6 ohne Bremsflüssigkeitsbehälter
1.6	62 - 82	12/07 →						
1.6 Flex	82	08/08 →						
RENAULT - SANDERO/STEPWAY II (B8_) 11/13 →								
 Hauptbremszylinder								
1.2 16V	54 - 55	12/13 →			für Linkslenker; + ABS		24.4120-1771.3 011076	Ø 20,6 ohne Bremsflüssigkeitsbehälter
1.2 16V LPG	53	12/13 →						
1.5 dCi	62	12/13 →						
1.6	59 - 83	11/13 →						
1.6 16V	75	04/14 →						
1.6 Flex	78	03/14 → 07/18						
TCe 90	66	09/15 →						

	kW					! #		
RENAULT - SCÉNIC I Großraumlimousine (JA0/1_, FA0_) 08/99→07/10								
 Bremskraftverstärker								
1.4 16V 1.6	70 75 - 79	09/99→08/03 09/99→09/03		→ 06/03; - ABS; für Linkslenker		03.7760-5102.4	300140	ATE Ø 10" pneumatisch
1.6 BiFuel 1.8 16V 1.9 dCi 1.9 dCi RX4	75 79 75 85 75	03/01→08/03 01/01→08/03 09/99→08/03 11/00→08/03		→ 06/03; für Linkslenker; + ABS		03.7863-2002.4	300126	ATE Ø 10" pneumatisch
2.0 16V 2.0 16V RX4	103 102	09/99→08/03 06/00→08/03						
1.6 BiFuel 1.8 4x4	79 85	09/99→04/01 07/00→04/01		- ABS; für Linkslenker		03.7760-5102.4	300140	ATE Ø 10" pneumatisch
1.9 D	47	09/99→03/01		+ ABS; für Linkslenker		03.7863-2002.4	300126	ATE Ø 10" pneumatisch
1.9 dTi 2.0 16V	72 102	09/99→08/03 07/00→08/03		→ 06/03; - ABS; für Linkslenker		03.7760-5102.4	300140	ATE Ø 10" pneumatisch
1.9 dTi	59	02/01→08/03		→ 06/03; für Linkslenker; + ABS		03.7863-2002.4	300126	ATE Ø 10" pneumatisch
 Hauptbremszylinder								
1.4 16V 1.6	70 75 - 79	09/99→08/03 09/99→09/03		→ 06/03; für Linkslenker; - ABS		03.2123-1551.3	010512	Ø 23,8
1.6 BiFuel 1.8 16V 1.9 dCi 1.9 dCi RX4	75 85 75 74 - 75	03/01→08/03 01/01→08/03 09/99→08/03 11/00→08/03		→ 06/03; für Linkslenker; + ABS / - ESP		03.2123-2146.3	010572	Ø 23,8
2.0 16V 2.0 16V RX4	102 - 103 102	09/99→08/03 06/00→08/03		→ 06/03; + ABS / + ESP; für Linkslenker		03.2123-2621.3	010701	ATE Ø 23,8
1.6 BiFuel 1.8 4x4	79 85	09/99→04/01 07/00→04/01		für Linkslenker; - ABS		03.2123-1551.3	010512	Ø 23,8
1.9 D	47	09/99→03/01		+ ABS / - ESP; für Linkslenker		03.2123-2146.3	010572	Ø 23,8
1.9 dTi	72	09/99→08/03		+ ABS / + ESP; für Linkslenker		03.2123-2621.3	010701	ATE Ø 23,8
1.9 dTi	59	02/01→08/03		→ 06/03; für Linkslenker; - ABS		03.2123-1551.3	010512	Ø 23,8
				→ 06/03; + ABS; für Linkslenker		03.2123-2146.3	010572	Ø 23,8
				→ 06/03; für Linkslenker; + ABS / - ESP		03.2123-2146.3	010572	Ø 23,8
				→ 06/03; + ABS / + ESP; für Linkslenker		03.2123-2621.3	010701	ATE Ø 23,8
RENAULT - SCÉNIC II (JM0/1_) 06/03→07/10								
 Hauptbremszylinder								
1.4 1.5 dCi	72 60 - 78	06/03→11/08 06/03→11/08				24.2123-1760.3	010779	TRW Ø 23,8
1.6 1.6 BiFuel 1.6 Hi-Flex 1.9 D 1.9 dCi	77 - 83 83 81 85 72 - 96	06/03→11/08 08/03→05/06 03/05→07/10 06/06→11/08 06/03→11/08				24.4123-1721.3	011052	BOS Ø 23,8 ohne Bremsflüssigkeitsbehälter
1.9 dCi 130 2.0 16V Turbo 2.0 dCi	97 120 110	10/05→12/09 05/04→11/08 09/05→11/08						
1.6 16V	82	10/05→11/08		01/07→		24.2123-1760.3	010779	TRW Ø 23,8
						24.4123-1721.3	011052	BOS Ø 23,8 ohne Bremsflüssigkeitsbehälter
2.0	99 - 101	06/03→06/09		→ 03/09		24.2123-1760.3	010779	TRW Ø 23,8
						24.4123-1721.3	011052	BOS Ø 23,8 ohne Bremsflüssigkeitsbehälter
RENAULT - SCÉNIC III (JZ0/1_) 12/08→								
 Hauptbremszylinder								
1.2 TCe	85 - 96	04/12→				24.4123-1715.3	010980	TRW Ø 23,8
1.4 16V 1.5 dCi	96 63 - 81	02/09→ 04/09→						
1.6 16V 1.6 16V Bifuel 1.6 dCi 1.9 dCi 2.0 16V 2.0 dCi	81 79 96 96 101 118	02/09→ 04/12→12/13 04/11→ 02/09→ 12/08→ 04/09→						
→								













	kw					! #		
RENAULT - SCÉNIC III (JZ0/1_) 12/08→								
 Hauptbremszylinder								
1.2 TCe	97	01/13→		03/13→			24.4123-1715.3 010980	TRW Ø 23,8
1.5 dCi	78	02/09→		04/09→			24.4123-1715.3 010980	TRW Ø 23,8
2.0 16V	103	02/09→						
2.0 dCi	110	02/09→						
1.6 16V Bifuel	81	02/09→		06/09→			24.4123-1715.3 010980	TRW Ø 23,8
1.6 E85	81	02/09→						
RENAULT - SCÉNIC III VAN (JZ0/1_) 12/08→								
 Hauptbremszylinder								
1.4 TCe	96	01/13→					24.4123-1715.3 010980	TRW Ø 23,8
1.5 dCi	70 - 81	04/09→						
1.6 dCi	96	01/13→						
1.6 VVT	81	01/13→						
1.9 dCi	96	01/13→						
RENAULT - THALIA I (LB_) 02/98→								
 Bremskraftverstärker								
1.2 16V	55	04/02→					03.7750-1332.4 300155	ATE Ø 9" pneumatisch
1.4	55	08/00→						
1.4 16V	72	08/00→						
1.5 dCi	47 - 62	06/01→						
1.6	82	01/04→12/08						
1.6 16V	79	07/00→02/09						
1.9 D	48	02/98→05/01						
 Hauptbremszylinder								
1.2 16V	55	04/02→		- ABS			03.2120-2031.3 010106	ATE Ø 20,6
1.4	55	08/00→		+ ABS			03.2120-4461.3 010571	ATE Ø 20,6
1.4 16V	72	08/00→						
1.5 dCi	47 - 62	06/01→						
1.4	72	05/00→02/09		- ABS			03.2120-2031.3 010106	ATE Ø 20,6
1.6	82	01/04→12/08		- ABS; 04/08→			03.2120-2031.3 010106	ATE Ø 20,6
				+ ABS			03.2120-4461.3 010571	ATE Ø 20,6
RENAULT - THALIA II (LU_) 09/08→								
 Hauptbremszylinder								
1.2 16V	55	09/08→06/14		- ABS			03.2120-2031.3 010106	ATE Ø 20,6
1.2 LPG	55	01/10→12/13						
1.4	55	09/08→06/14						
1.5 dCi	47 - 66	09/08→						
1.4	72	01/09→12/11		für Linkslenker; + ABS			03.2120-4461.3 010571	ATE Ø 20,6
1.6 16V	77 - 79	09/08→		+ ABS			03.2120-4461.3 010571	ATE Ø 20,6
RENAULT - THALIA III (L8_) 12/13→								
 Hauptbremszylinder								
0.9 TCe	66	06/14→		für Linkslenker; + ABS			24.4120-1771.3 011076	Ø 20,6 ohne Bremsflüssigkeitsbehälter
1.2 16V	55	12/13→						
1.2 LPG	55	03/14→						
1.5 dCi	55 - 70	12/13→						
1.0 SCe	54	01/17→11/19		für Linkslenker			24.4120-1771.3 011076	Ø 20,6 ohne Bremsflüssigkeitsbehälter
RENAULT - TRAFIC II Bus (JL) 03/01→								
 Hauptbremszylinder								
1.9 dCi	59	04/01→07/03		für Linkslenker; - ESP			24.2120-1738.3 010759	TRW Ø 20,6
				für Rechtslenker; - ESP			24.2125-1731.3 010826	TRW Ø 25,4
1.9 dCi	75	01/12→12/18		für Linkslenker; - ESP			24.2120-1740.3 010764	TRW Ø 20,6
				für Rechtslenker; - ESP			24.2125-1731.3 010826	TRW Ø 25,4
1.9 dCi 100	74	03/01→10/06		→ 09/03; für Linkslenker; - ESP			24.2120-1738.3 010759	TRW Ø 20,6
				10/03→; für Linkslenker; - ESP			24.2120-1740.3 010764	TRW Ø 20,6
				10/03→; für Rechtslenker; - ESP			24.2125-1731.3 010826	TRW Ø 25,4
1.9 dCi 80	60	03/01→10/06		→ 09/03; für Linkslenker; - ESP			24.2120-1738.3 010759	TRW Ø 20,6
				10/03→; für Linkslenker; - ESP			24.2120-1740.3 010764	TRW Ø 20,6
				für Rechtslenker; - ESP			24.2125-1731.3 010826	TRW Ø 25,4
→								













	kw					! #		
RENAULT - TRAFIC II Bus (JL) 03/01→								
 Hauptbremszylinder								
2.0	88	03/01→			→ 08/14; - ESP		24.2125-1731.3 010826	TRW Ø 25,4
2.0 16V	86	08/06→			für Linkslenker; → 08/14; - ESP		24.2120-1740.3 010764	TRW Ø 20,6
					für Rechtslenker; → 08/14; - ESP		24.2125-1731.3 010826	TRW Ø 25,4
2.0 dCi 115 2.5 dCi 145	84	08/06→			10/06→ 08/14; + ABS / - ESP		24.2120-1748.3 010894	TRW Ø 20,6
	107	08/06→			10/06→ 08/14; + ABS / + ESP		24.2120-1753.3 010946	TRW Ø 20,6
2.0 dCi 90	66	08/06→			10/06→ 08/14; - ESP		24.2125-1731.3 010826	TRW Ø 25,4
2.5 dCi 115	84	02/08→			→ 08/14; + ABS / - ESP		24.2120-1748.3 010894	TRW Ø 20,6
					→ 08/14; + ABS / + ESP		24.2120-1753.3 010946	TRW Ø 20,6
2.5 dCi 135	99	05/03→10/06			- ESP		24.2125-1731.3 010826	TRW Ø 25,4
RENAULT - TRAFIC II Kasten (FL) 03/01→								
 Hauptbremszylinder								
1.9 dCi	59	04/01→07/03			für Linkslenker; - ESP		24.2120-1738.3 010759	TRW Ø 20,6
					für Rechtslenker; - ESP		24.2125-1731.3 010826	TRW Ø 25,4
1.9 dCi	75	03/01→			→ 09/03; für Linkslenker; - ESP		24.2120-1738.3 010759	TRW Ø 20,6
					10/03→ 08/14; für Linkslenker; - ESP		24.2120-1740.3 010764	TRW Ø 20,6
					für Rechtslenker; → 08/14; - ESP		24.2125-1731.3 010826	TRW Ø 25,4
1.9 dCi 100	74	03/01→10/06			→ 09/03; für Linkslenker; - ESP		24.2120-1738.3 010759	TRW Ø 20,6
					10/03→; für Linkslenker; - ESP		24.2120-1740.3 010764	TRW Ø 20,6
					10/03→; für Rechtslenker; - ESP		24.2125-1731.3 010826	TRW Ø 25,4
1.9 dCi 80	60	03/01→10/06			→ 09/03; für Linkslenker; - ESP		24.2120-1738.3 010759	TRW Ø 20,6
					10/03→; für Linkslenker; - ESP		24.2120-1740.3 010764	TRW Ø 20,6
					für Rechtslenker; - ESP		24.2125-1731.3 010826	TRW Ø 25,4
2.0 2.5 dCi	88	03/01→			→ 08/14; - ESP		24.2125-1731.3 010826	TRW Ø 25,4
	84	08/07→						
2.0 16V	86	08/06→			für Linkslenker; → 08/14; - ESP		24.2120-1740.3 010764	TRW Ø 20,6
					für Rechtslenker; → 08/14; - ESP		24.2125-1731.3 010826	TRW Ø 25,4
2.0 dCi 115 2.5 dCi 145	84	08/06→			10/06→ 08/14; + ABS / - ESP		24.2120-1748.3 010894	TRW Ø 20,6
	107	08/06→			10/06→ 08/14; + ABS / + ESP		24.2120-1753.3 010946	TRW Ø 20,6
2.0 dCi 90	66	08/06→			10/06→ 08/14; - ESP		24.2125-1731.3 010826	TRW Ø 25,4
2.5 dCi 135	99	05/03→10/06			- ESP		24.2125-1731.3 010826	TRW Ø 25,4
RENAULT - TRAFIC II Pritsche/Fahrgestell (EL) 03/01→								
 Hauptbremszylinder								
1.9 dCi	59	09/01→07/03			für Linkslenker; - ESP		24.2120-1738.3 010759	TRW Ø 20,6
					für Rechtslenker; - ESP		24.2125-1731.3 010826	TRW Ø 25,4
1.9 dCi 100	74	03/01→10/06			→ 09/03; für Linkslenker; - ESP		24.2120-1738.3 010759	TRW Ø 20,6
					10/03→; für Linkslenker; - ESP		24.2120-1740.3 010764	TRW Ø 20,6
					10/03→; für Rechtslenker; - ESP		24.2125-1731.3 010826	TRW Ø 25,4
1.9 dCi 80	60	03/01→10/06			→ 09/03; für Linkslenker; - ESP		24.2120-1738.3 010759	TRW Ø 20,6
					10/03→; für Linkslenker; - ESP		24.2120-1740.3 010764	TRW Ø 20,6
					für Rechtslenker; - ESP		24.2125-1731.3 010826	TRW Ø 25,4
2.0	88	03/01→10/06			- ESP		24.2125-1731.3 010826	TRW Ø 25,4
2.0 16V	86	08/06→			für Linkslenker; → 08/14; - ESP		24.2120-1740.3 010764	TRW Ø 20,6
					für Rechtslenker; → 08/14; - ESP		24.2125-1731.3 010826	TRW Ø 25,4
2.0 dCi 115 2.5 dCi 145	84	08/06→			10/06→ 08/14; + ABS / - ESP		24.2120-1748.3 010894	TRW Ø 20,6
	107	08/06→			10/06→ 08/14; + ABS / + ESP		24.2120-1753.3 010946	TRW Ø 20,6
2.0 dCi 90	66	08/06→			10/06→ 08/14; - ESP		24.2125-1731.3 010826	TRW Ø 25,4
2.5 dCi	84	08/07→			→ 08/14; - ESP		24.2125-1731.3 010826	TRW Ø 25,4
2.5 dCi 135	99	03/01→10/06			05/03→; - ESP		24.2125-1731.3 010826	TRW Ø 25,4
RENAULT - TRAFIC Bus (T_, P_, V_) 03/89→03/01								
 Hauptbremszylinder								
2.5 D	55	05/89→03/01			11/97→; + ABS		24.2025-1706.3 010676	Ø 25,4
2.5 D 4x4	55	08/89→03/01			11/97→; - ABS		24.2025-1708.3 010692	Ø 25,4
RENAULT - TRAFIC Kasten (T_, P_, V_) 03/89→10/02								
 Hauptbremszylinder								
2.5 D	55	05/89→03/01			11/97→; + ABS		24.2025-1706.3 010676	Ø 25,4
2.5 D 4x4	55	05/89→03/01			11/97→; - ABS		24.2025-1708.3 010692	Ø 25,4









	kw					! #		
RENAULT - TWINGO I (C06_) 03/93→10/12								
 Hauptbremszylinder								
1.2	40 - 43	05/96→06/07		- ABS			24.2120-1706.3 010262	Ø 20,6
1.2 16V	44 - 55	01/01→06/07		+ ABS			24.2120-1723.3 010545	BDX Ø 20,6
1.2 LPG	43	09/00→06/07						
1.2 LPG	44	10/03→06/07		08/04→; - ABS			24.2120-1706.3 010262	Ø 20,6
				08/04→; + ABS			24.2120-1723.3 010545	BDX Ø 20,6
RENAULT - TWINGO I Kasten/Schrägheck (S06_) 03/93→06/12								
 Hauptbremszylinder								
1.2	43 - 55	05/96→06/12		- ABS			24.2120-1706.3 010262	Ø 20,6
				+ ABS			24.2120-1723.3 010545	BDX Ø 20,6
RENAULT - TWINGO II (CNO_) 03/07→								
 Bremskraftverstärker								
1.2	43	03/07→09/14		für Linkslenker; → 07/14; + ESP			03.7750-7332.4 300298	ATE Ø 9" pneumatisch
1.2 16V	55 - 56	03/07→		für Linkslenker; → 07/14; - ESP			03.7853-3902.4 300270	ATE Ø 9" pneumatisch
1.2 TCe 100	75	02/11→						
1.2 Turbo	74	03/07→09/14						
1.5 dCi	47 - 62	03/07→09/14						
1.5 dCi 75	55	10/10→						
1.5 dCi 90	63	10/10→						
1.6 RS	98	05/08→09/14		für Linkslenker; → 07/14			03.7750-8832.4 300299	ATE Ø 9" pneumatisch
 Hauptbremszylinder								
1.2	43	03/07→09/14		für Linkslenker; → 07/14; - ESP			03.2120-4581.3 010915	ATE Ø 20,6
1.2 16V	55 - 56	03/07→		für Linkslenker; → 07/14; + ESP			03.2120-4641.3 010932	ATE Ø 20,6
1.2 TCe 100	75	02/11→						
1.2 Turbo	74	03/07→09/14						
1.5 dCi	47 - 62	03/07→09/14						
1.5 dCi 75	55	10/10→						
1.5 dCi 90	63	10/10→						
1.6 RS	98	05/08→09/14		für Linkslenker; → 07/14			03.2123-2751.3 011014	ATE Ø 23,8
RENAULT - TWINGO II Kasten/Schrägheck (CNO_) 09/10→09/14								
 Bremskraftverstärker								
1.2	55	09/10→09/14		für Linkslenker; + ESP			03.7750-7332.4 300298	ATE Ø 9" pneumatisch
1.5 dCi	55	10/10→09/14		für Linkslenker; - ESP			03.7853-3902.4 300270	ATE Ø 9" pneumatisch
 Hauptbremszylinder								
1.2	55	09/10→09/14		für Linkslenker; - ESP			03.2120-4581.3 010915	ATE Ø 20,6
1.5 dCi	55	10/10→09/14		für Linkslenker; + ESP			03.2120-4641.3 010932	ATE Ø 20,6
RENAULT - TWINGO III (BCM_, BCA_) 09/14→								
 Hauptbremszylinder								
0.9 TCe 110	80	11/16→					24.4150-1071.3 011046	ATE Ø 20,6 ohne Bremsflüssigkeitsbehälter
0.9 TCe 90	66	09/14→						
0.9 TCe 90 LPG	66	08/18→						
0.9 TCe 95	68	03/19→						
1.0 S Ce 65	48	03/19→						
1.0 S Ce 70	51 - 52	09/14→						
1.0 S Ce 75	54	03/19→						
Z.E:	60	05/20→						
RENAULT - VEL SATIS (BJO_) 06/02→								
 Bremskraftverstärker								
2.0 16 V Turbo	125	04/04→		→ 10/05; für Linkslenker; für Fahrzeuge ohne autom. Distanzregelung			03.7858-2802.4 300303	ATE Ø 9 / 8" pneumatisch
2.0 16V Turbo	120	06/02→08/09						
2.0 Turbo	108	04/05→						
2.2 dCi	83 - 110	06/02→						
3.0 dCi	130	06/02→06/06						
3.5	170	10/04→						
3.5 V6	177	06/02→						
→								















	kW			 	! #		
RENAULT - VEL SATIS (BJ0_) 06/02→							
Pedalwegsensord, Bremspedal							
2.0 16 V Turbo	125	04/04→		→ 10/05; für Fahrzeuge mit autom. Distanzregelung		03.0655-0005.2 370005	ATE
2.0 16V Turbo	120	06/02→08/09					
2.0 Turbo	108	04/05→					
2.2 dCi	83 - 110	06/02→					
3.0 dCi	130	06/02→06/06					
3.5	170	10/04→					
3.5 V6	177	06/02→					
 Hauptbremszylinder							
2.0 16 V Turbo	125	04/04→		→ 03/05		03.4125-0014.3 010794	ATE Ø 25,4
2.2 dCi	83 - 102	04/04→		04/05→ 12/09		03.4155-0043.3 010795	ATE Ø 25,4
3.5 V6	177	06/02→					
2.0 16V Turbo	120	06/02→08/09		→ 03/05		03.4125-0014.3 010794	ATE Ø 25,4
2.2 dCi	110	06/02→08/09		04/05→		03.4155-0043.3 010795	ATE Ø 25,4
3.0 dCi	130	06/02→06/06					
2.0 dCi	110 - 127	08/05→		→ 12/09		03.4155-0043.3 010795	ATE Ø 25,4
2.0 Turbo	108	04/05→					
3.0 dCi	133	06/06→08/09				03.4155-0043.3 010795	ATE Ø 25,4
3.5	170	10/04→		→ 03/05		03.4125-0014.3 010794	ATE Ø 25,4
				→ 12/09		03.4155-0043.3 010795	ATE Ø 25,4
RENAULT - WIND (E4M_) 07/10→							
 Bremskraftverstärker							
1.2	74	07/10→		für Linkslenker; → 09/13		03.7750-8832.4 300299	ATE Ø 9" pneumatisch
1.2 TCe 100	75	02/11→					
1.6	98	07/10→					
 Hauptbremszylinder							
1.2	74	07/10→		für Linkslenker; → 09/13		03.2123-2751.3 011014	ATE Ø 23,8
1.2 TCe 100	75	02/11→					
1.6	98	07/10→					
SAAB - 9-3 (YS3D) 02/98→08/03							
 Bremskraftverstärker							
2.0 i	96	02/98→09/02		01/01→; für Linkslenker		03.7750-2932.4 300175	ATE Ø 9" pneumatisch
2.0 SE Turbo	147	02/98→09/02					
2.0 Turbo	113 - 151	02/98→09/02					
2.2 TiD	92	11/00→09/02					
2.3 i	110	02/98→09/02					
2.0 Turbo	110	03/99→09/02		für Linkslenker		03.7750-2932.4 300175	ATE Ø 9" pneumatisch
 Hauptbremszylinder							
2.0 i	96	02/98→09/02		→ 12/00; für Linkslenker		03.2123-1121.3 010176	Ø 23,8
2.0 SE Turbo	147	02/98→09/02					
2.0 Turbo	113 - 151	02/98→09/02		01/01→		03.2123-1626.3 010727	ATE Ø 23,8
2.2 TiD	92	11/00→09/02					
2.3 i	110	02/98→09/02					
2.0 Turbo	110	03/99→09/02				03.2123-1626.3 010727	ATE Ø 23,8
2.2 TiD	85	02/98→11/00		für Linkslenker		03.2123-1121.3 010176	Ø 23,8
SAAB - 9-3 (YS3F, E79, D79, D75) 09/02→02/15							
 Hauptbremszylinder							
1	110	09/02→02/15		für Linkslenker; → 06/12		24.2125-1732.3 010827	TRW Ø 25,4
8t	110	09/02→02/15					
8t BioPower	110	01/07→02/15					
1.9 TiD	88 - 110	09/04→02/15					
1.9 TTiD	96 - 132	12/07→02/15					
2.0 t	120 - 177	09/02→02/15					
2.0 t BioPower	129 - 154	09/02→02/15					
2.0 t Bio Power	120 - 162	01/07→02/15					
2.0 t BioPower XWD	120 - 162	01/08→02/15					
2.0 Turbo Performance	185	04/04→02/15					
2.0 Turbo XWD	154	01/08→02/15					
2.0 t XWD	120 - 177	01/07→02/15					
→							















	kw					! #		
SAAB - 9-3 (YS3F, E79, D79, D75) 09/02→02/15								
 Hauptbremszylinder								
2.2 TiD	92	09/02→02/15			für Linkslenker; → 06/12		24.2125-1732.3 010827	TRW Ø 25,4
1.8 i	90	01/04→02/15			03/04→; für Linkslenker; → 06/12		24.2125-1732.3 010827	TRW Ø 25,4
2.0 T16	143	06/06→02/15			für Linkslenker		24.2125-1732.3 010827	TRW Ø 25,4
2.8 Turbo V6	184	03/05→02/15			→ 12/05; für Linkslenker		24.2125-1732.3 010827	TRW Ø 25,4
SAAB - 9-3 Cabriolet (YS3D) 02/98→08/03								
 Bremskraftverstärker								
2.0 i	96	02/98→08/03			09/00→ 07/03; für Linkslenker		03.7750-2932.4 300175	ATE Ø 9" pneumatisch
2.0 Turbo	113 - 151	02/98→08/03						
2.3 i	110	02/98→08/03						
2.3 Turbo	165	10/99→08/03						
2.0 SE Turbo	147	02/98→08/03			01/01→ 07/03; für Linkslenker		03.7750-2932.4 300175	ATE Ø 9" pneumatisch
2.0 Turbo	110	01/01→08/03			→ 07/03; für Linkslenker		03.7750-2932.4 300175	ATE Ø 9" pneumatisch
2.3	169	09/99→01/02			09/00→; für Linkslenker		03.7750-2932.4 300175	ATE Ø 9" pneumatisch
 Hauptbremszylinder								
2.0 i	96	02/98→08/03			→ 08/00; für Linkslenker		03.2123-1121.3 010176	Ø 23,8
2.0 Turbo	113 - 151	02/98→08/03			09/00→ 07/03		03.2123-1626.3 010727	ATE Ø 23,8
2.3 i	110	02/98→08/03						
2.3 Turbo	165	10/99→08/03						
2.0 SE Turbo	147	02/98→08/03			→ 08/00; für Linkslenker		03.2123-1121.3 010176	Ø 23,8
					01/01→ 07/03		03.2123-1626.3 010727	ATE Ø 23,8
2.0 Turbo	110	01/01→08/03			→ 07/03		03.2123-1626.3 010727	ATE Ø 23,8
2.3	169	09/99→01/02			10/99→ 08/00; für Linkslenker		03.2123-1121.3 010176	Ø 23,8
					09/00→		03.2123-1626.3 010727	ATE Ø 23,8
SAAB - 9-3 Cabriolet (YS3F) 08/03→02/15								
 Hauptbremszylinder								
1	110	08/03→02/15			→ 06/12; für Linkslenker		24.2125-1732.3 010827	TRW Ø 25,4
8t	110	08/03→02/15						
8t BioPower	110	01/07→02/15						
1.8 i	90	01/04→02/15						
1.9 TiD	88 - 110	09/04→02/15						
1.9 TTiD	96 - 132	12/07→02/15						
2.0 t	120 - 162	08/03→02/15						
2.0 t BioPower	120 - 162	01/07→02/15						
2.0 Turbo Performance	185	04/04→02/15						
2.0	130 - 143	09/04→09/07			für Linkslenker		24.2125-1732.3 010827	TRW Ø 25,4
2.0 t BioPower	147	06/07→02/15			07/07→ 06/12; für Linkslenker		24.2125-1732.3 010827	TRW Ø 25,4
2.0 T BioPower	145	06/07→02/15						
SAAB - 9-3 Kombi (E50) 03/05→02/15								
 Hauptbremszylinder								
1.8 i	90	03/05→02/15			→ 06/12; für Linkslenker		24.2125-1732.3 010827	TRW Ø 25,4
1.8 t	110	03/05→02/15						
1.8t 2.0	110	03/05→02/15						
1.9 TiD	88 - 110	03/05→02/15						
1.9 TTiD	96 - 132	12/07→02/15						
2.0 t	110 - 177	03/05→02/15						
2.0 T16	143	04/06→02/15						
2.0 t BioPower	110 - 162	01/07→02/15						
2.0 t Bio Power	147	02/09→02/15						
2.0 t BioPower XWD	120 - 162	01/07→02/15						
2.0 t Bio Power XWD	154	06/08→02/15						
2.0 t XWD	120 - 177	01/07→02/15						
2.0 t XWD	154	06/08→02/15			07/08→ 06/12; für Linkslenker		24.2125-1732.3 010827	TRW Ø 25,4
SAAB - 9-3X (YS3) 02/09→02/15								
 Hauptbremszylinder								
1.9 TTiD AWD	132	02/09→12/12			03/09→ 06/12; für Linkslenker		24.2125-1732.3 010827	TRW Ø 25,4











	kw			 	! #		
SAAB - 9-3X (YS3) 02/09→02/15							
 Hauptbremszylinder							
2.0 t BioPower XWD 2.0 t XWD	154 154	02/09→12/12 02/09→02/15		03/09→ 06/12; für Linkslenker		24.2125-1732.3 010827	TRW Ø 25,4
2.0 T16 XWD 2.0 t BioPower XWD	162 162	01/11→02/15 01/11→12/12		→ 06/12; für Linkslenker		24.2125-1732.3 010827	TRW Ø 25,4
SAAB - 9-5 (YS3E) 09/97→12/09							
 Bremskraftverstärker							
1.9 TiD 2.0 t BioPower 2.2 TiD 2.3 t BioPower 2.3 Turbo	110 110 88 136 - 152 134 - 191	01/06→12/09 01/05→12/09 03/02→12/09 11/06→12/09 07/03→12/09		für Linkslenker		03.7745-3902.4 300129	ATE Ø 8 / 7" pneumatisch
2.0 t 2.3 t	110 - 136 125 - 136	09/97→12/09 09/97→12/09		→ 12/01; für Linkslenker 01/02→; für Linkslenker		03.7745-3003.4 300157 03.7745-3902.4 300129	ATE Ø 8 / 7" pneumatisch ATE Ø 8 / 7" pneumatisch
2.3 Turbo 3.0 TiD 3.0 V6t	184 130 147	09/01→12/09 07/01→08/05 01/98→08/05					
2.0 t Biopower 2.0 Turbo SE 2.3 Turbo 2.3 Turbo	132 141 169 224	09/05→12/09 10/98→07/00 10/99→09/01 06/03→08/05		06/06→; für Linkslenker für Linkslenker → 03/04; für Linkslenker		03.7745-3902.4 300129 03.7745-3003.4 300157 03.7745-3902.4 300129	ATE Ø 8 / 7" pneumatisch ATE Ø 8 / 7" pneumatisch ATE Ø 8 / 7" pneumatisch
SAAB - 9-5 (YS3G) 01/10→01/12							
 Bremskraftverstärker							
1.6 Turbo 2.0 t BioPower 2.0 t BioPower XWD 2.0 TiD 2.0 TTiD 2.0 TTiD XWD 2.0 Turbo 2.0 Turbo XWD 2.8 Turbo V6 XWD	132 162 162 118 140 140 162 162 221	05/10→01/12 05/10→01/12 05/10→01/12 05/10→01/12 05/10→01/12 05/10→01/12 05/10→01/12 05/10→01/12 05/10→01/12		für Linkslenker		03.7858-0732.4 300272	ATE Ø 9 / 8" pneumatisch
 Hauptbremszylinder							
1.6 Turbo 2.0 t BioPower 2.0 t BioPower XWD 2.0 TiD 2.0 TTiD 2.0 TTiD XWD 2.0 Turbo 2.0 Turbo XWD 2.8 Turbo V6 XWD	132 162 162 118 140 140 162 162 221	05/10→01/12 05/10→01/12 05/10→01/12 05/10→01/12 05/10→01/12 05/10→01/12 05/10→01/12 05/10→01/12 05/10→01/12		für Linkslenker für Rechtslenker		03.2125-0421.3 010934 24.4155-0201.3 011125	ATE Ø 25,4 ATE Ø 25,4 ohne Bremsflüssigkeitsbehälter
SAAB - 9-5 Kombi (YS3E) 10/98→12/09							
 Bremskraftverstärker							
1.9 TiD 2.0 t BioPower 2.2 TiD 2.3 t BioPower 2.3 Turbo	110 - 129 110 88 136 - 152 162 - 224	01/06→12/09 01/06→12/09 03/02→12/09 11/06→12/09 06/03→12/09		für Linkslenker		03.7745-3902.4 300129	ATE Ø 8 / 7" pneumatisch
2.0 t 2.3 t	110 125 - 136	10/98→12/09 10/98→12/09		→ 12/01; für Linkslenker 01/02→; für Linkslenker		03.7745-3003.4 300157 03.7745-3902.4 300129	ATE Ø 8 / 7" pneumatisch ATE Ø 8 / 7" pneumatisch
3.0 TiD 3.0 V6t	130 147	07/01→08/05 10/98→08/05					
2.0 t 2.3 Turbo 2.0 t Biopower 2.3 t BioPower 2.3 Turbo	136 - 141 169 154 184	10/98→07/01 10/99→09/01 09/05→12/09 11/06→12/09 09/01→12/09		für Linkslenker 06/06→; für Linkslenker 01/07→; für Linkslenker 01/02→; für Linkslenker		03.7745-3003.4 300157 03.7745-3902.4 300129 03.7745-3902.4 300129 03.7745-3902.4 300129	ATE Ø 8 / 7" pneumatisch ATE Ø 8 / 7" pneumatisch ATE Ø 8 / 7" pneumatisch ATE Ø 8 / 7" pneumatisch
SEAT - ALHAMBRA (7V8, 7V9) 04/96→03/10							
 Bremskraftverstärker							
1.8 T 20V →	110	10/97→03/10		7M-W-507042→; → 05/00; für Linkslenker; + ABS		03.7755-1902.4 300138	ATE Ø 9 / 8" pneumatisch











	kw			 	! #								
SEAT - ALHAMBRA (7V8, 7V9) 04/96→03/10													
 Bremskraftverstärker													
1.8 T 20V	110	10/97→03/10		06/00→; → 7M-3-515799; für Linkslenker; - ESP	03.7755-6302.4	300221	ATE Ø 9 / 8" pneumatisch						
				06/00→; für Rechtslenker; - ESP	03.7755-6302.4	300221	ATE Ø 9 / 8" pneumatisch						
				7M-3-515800→; für Linkslenker; - ESP	03.7755-6302.4	300221	ATE Ø 9 / 8" pneumatisch						
				05/98→; → 7M-W-507041; für Linkslenker; + ABS	03.7760-3002.4	300120	ATE Ø 10" pneumatisch						
				05/98→ 05/00; für Rechtslenker; + ABS	03.7760-3002.4	300120	ATE Ø 10" pneumatisch						
				06/00→; → 7M-3-515799; für Linkslenker; + ESP	03.7858-3302.4	300122	ATE Ø 9 / 8" pneumatisch						
				7M-3-515800→; für Linkslenker; + ESP	03.7858-9502.4	300205	ATE Ø 9 / 8" pneumatisch						
1.9 TDI 2.0 i	66 85	04/96→03/10 04/96→03/10		7M-W-507042→; → 05/00; für Linkslenker; + ABS	03.7755-1902.4	300138	ATE Ø 9 / 8" pneumatisch						
				06/00→; → 7M-3-515799; für Linkslenker; - ESP	03.7755-6302.4	300221	ATE Ø 9 / 8" pneumatisch						
				06/00→; für Rechtslenker; - ESP	03.7755-6302.4	300221	ATE Ø 9 / 8" pneumatisch						
				7M-3-515800→; für Linkslenker; - ESP	03.7755-6302.4	300221	ATE Ø 9 / 8" pneumatisch						
				→ 05/00; für Rechtslenker; + ABS	03.7760-3002.4	300120	ATE Ø 10" pneumatisch						
				→ 7M-W-507041; für Linkslenker; + ABS	03.7760-3002.4	300120	ATE Ø 10" pneumatisch						
				06/00→; → 7M-3-515799; für Linkslenker; + ESP	03.7858-3302.4	300122	ATE Ø 9 / 8" pneumatisch						
1.9 TDI	81	08/96→06/00		7M-W-507042→; → 05/00; für Linkslenker; + ABS	03.7755-1902.4	300138	ATE Ø 9 / 8" pneumatisch						
				10/97→ 05/00; für Rechtslenker; + ABS	03.7760-3002.4	300120	ATE Ø 10" pneumatisch						
1.9 TDI 2.8 V6	85 - 96 150	06/00→03/10 06/00→03/10		7M-3-515800→; für Linkslenker; - ESP	03.7755-6302.4	300221	ATE Ø 9 / 8" pneumatisch						
				für Rechtslenker; - ESP	03.7755-6302.4	300221	ATE Ø 9 / 8" pneumatisch						
				→ 7M-3-515799; für Linkslenker; - ESP	03.7755-6302.4	300221	ATE Ø 9 / 8" pneumatisch						
				→ 7M-3-515799; für Linkslenker; + ESP	03.7858-3302.4	300122	ATE Ø 9 / 8" pneumatisch						
				7M-3-515800→; für Linkslenker; + ESP	03.7858-9502.4	300205	ATE Ø 9 / 8" pneumatisch						
1.9 TDI 2.0 TDI	110 103	05/05→05/07 11/05→03/10		- ESP	03.7755-6302.4	300221	ATE Ø 9 / 8" pneumatisch						
				für Linkslenker; + ESP	03.7858-9502.4	300205	ATE Ø 9 / 8" pneumatisch						
1.9 TDI 4motion 2.8 V6 4motion	85 150	06/00→03/10 06/00→03/10		02/01→; → 7M-3-515799; für Linkslenker; - ESP	03.7755-6302.4	300221	ATE Ø 9 / 8" pneumatisch						
				02/01→; für Rechtslenker; - ESP	03.7755-6302.4	300221	ATE Ø 9 / 8" pneumatisch						
				7M-3-515800→; für Linkslenker; - ESP	03.7755-6302.4	300221	ATE Ø 9 / 8" pneumatisch						
				02/01→; → 7M-3-515799; für Linkslenker; + ESP	03.7858-3302.4	300122	ATE Ø 9 / 8" pneumatisch						
				7M-3-515800→; für Linkslenker; + ESP	03.7858-9502.4	300205	ATE Ø 9 / 8" pneumatisch						
Pedalwegsensoren, Bremspedal													
1.8 T 20V 1.9 TDI 1.9 TDI 4motion 2.0 i 2.8 V6 2.8 V6 4motion	110 66 - 96 85 85 150 150	10/97→03/10 04/96→03/10 06/00→03/10 04/96→03/10 06/00→03/10 06/00→03/10		7M-3-515800→; für Linkslenker; + ESP	03.0655-0006.2	370006	ATE						
			1.9 TDI 2.0 TDI	110 103	05/05→05/07 11/05→03/10		für Linkslenker; + ESP	03.0655-0006.2	370006	ATE			
						Hauptbremszylinder							
						1.8 T 20V	110	10/97→03/10		05/98→; → 7M-W-507041; + ABS	03.2123-1526.3	010477	Ø 23,8
										05/98→; → 7M-W-507041; - ABS	03.2123-1548.3	010478	Ø 23,8
										06/00→; → 7M-3-515799; - ESP	03.2125-0332.3	010952	Ø 25,4
	7M-W-507042→; → 05/00; + ABS	03.2125-0332.3	010952	Ø 25,4									
	7M-3-515800→; - ESP	03.2125-0332.3	010952	Ø 25,4									
	7M-W-507042→; → 05/00; - ABS	03.2125-8404.3	010583	ATE Ø 25,4									
	06/00→; → 7M-3-515799; + ESP	03.2125-9604.3	010581	Ø 25,4									
1.9 TDI 2.0 i	66 85	04/96→03/10 04/96→03/10		→ 7M-W-507041; + ABS	03.2123-1526.3	010477	Ø 23,8						
				→ 7M-W-507041; - ABS	03.2123-1548.3	010478	Ø 23,8						
				06/00→; → 7M-3-515799; - ESP	03.2125-0332.3	010952	Ø 25,4						
				7M-W-507042→; → 05/00; + ABS	03.2125-0332.3	010952	Ø 25,4						
				7M-3-515800→; - ESP	03.2125-0332.3	010952	Ø 25,4						
				7M-W-507042→; → 05/00; - ABS	03.2125-8404.3	010583	ATE Ø 25,4						
			06/00→; → 7M-3-515799; + ESP	03.2125-9604.3	010581	Ø 25,4							
→													

	kw					! #		
SEAT - ALHAMBRA (7V8, 7V9) 04/96→03/10								
 Hauptbremszylinder								
1.9 TDI	81	08/96→06/00		10/97→; → 7M-W-507041; + ABS		03.2123-1526.3 010477	Ø 23,8	
				10/97→; → 7M-W-507041; - ABS		03.2123-1548.3 010478	Ø 23,8	
				7M-W-507042→; → 05/00; + ABS		03.2125-0332.3 010952	Ø 25,4	
				7M-W-507042→; → 05/00; - ABS		03.2125-8404.3 010583	ATE Ø 25,4	
1.9 TDI	85 - 96	06/00→03/10		→ 7M-3-515799; - ESP		03.2125-0332.3 010952	Ø 25,4	
2.8 V6	150	06/00→03/10		7M-3-515800→; - ESP		03.2125-0332.3 010952	Ø 25,4	
				→ 7M-3-515799; + ESP		03.2125-9604.3 010581	Ø 25,4	
1.9 TDI	110	05/05→05/07		- ESP		03.2125-0332.3 010952	Ø 25,4	
2.0 TDI	103	11/05→03/10						
1.9 TDI 4motion	85	06/00→03/10		02/01→; → 7M-3-515799; - ESP		03.2125-0332.3 010952	Ø 25,4	
2.8 V6 4motion	150	06/00→03/10		7M-3-515800→; - ESP		03.2125-0332.3 010952	Ø 25,4	
				02/01→; → 7M-3-515799; + ESP		03.2125-9604.3 010581	Ø 25,4	
Verschlusschraube, Hauptbremszylinder								
1.8 T 20V	110	10/97→03/10		05/98→; → 7M-W-507041; - ABS		03.3517-5100.1 390326		
1.9 TDI	66	04/96→03/10		→ 7M-W-507041; - ABS		03.3517-5100.1 390326		
2.0 i	85	04/96→03/10						
1.9 TDI	81	08/96→06/00		10/97→; → 7M-W-507041; - ABS		03.3517-5100.1 390326		
SEAT - ALHAMBRA (710, 711) 06/10→12/22								
 Bremskraftverstärker								
1.4 TSI	110	06/10→04/15		für Linkslenker		03.7873-4502.4 300284	ATE Ø 11" pneumatisch	
1.8 TSI	118	11/12→04/15						
2.0 TDI	85 - 130	06/10→12/22						
2.0 TDI 4Drive	103	05/11→04/15						
2.0 TSI	147	11/10→05/12						
 Hauptbremszylinder								
1.4 TSI	110	06/10→12/22		für Linkslenker		03.4153-0186.3 010816	ATE Ø 23,8	
1.8 TSI	118	11/12→04/15		für Rechtslenker		24.4153-0222.3 011047	ATE Ø 23,8 ohne Bremsflüssigkeitsbehälter	
2.0 TDI	85 - 135	06/10→12/22						
2.0 TDi 4Drive	130	11/18→12/22						
2.0 TDI 4Drive	103 - 135	05/11→12/22						
2.0 TSI	147 - 162	11/10→12/22						
SEAT - ALHAMBRA VAN (7V8, 7V9) 03/96→03/10								
 Bremskraftverstärker								
1.9 TDI	96	11/02→11/08		7M-3-515800→; für Linkslenker; - ESP		03.7755-6302.4 300221	ATE Ø 9 / 8" pneumatisch	
1.9 TDI 4motion	85	06/02→05/08		für Rechtslenker; - ESP		03.7755-6302.4 300221	ATE Ø 9 / 8" pneumatisch	
				→ 7M-3-515799; für Linkslenker; - ESP		03.7755-6302.4 300221	ATE Ø 9 / 8" pneumatisch	
				→ 7M-3-515799; für Linkslenker; + ESP		03.7858-3302.4 300122	ATE Ø 9 / 8" pneumatisch	
				7M-3-515800→; für Linkslenker; + ESP		03.7858-9502.4 300205	ATE Ø 9 / 8" pneumatisch	
Pedalwegsensor, Bremspedal								
1.9 TDI	96	11/02→11/08		7M-3-515800→; für Linkslenker; + ESP		03.0655-0006.2 370006	ATE	
1.9 TDI 4motion	85	06/02→05/08						
 Hauptbremszylinder								
1.9 TDI	96	11/02→11/08		→ 7M-3-515799; - ESP		03.2125-0332.3 010952	Ø 25,4	
1.9 TDI 4motion	85	06/02→05/08		7M-3-515800→; - ESP		03.2125-0332.3 010952	Ø 25,4	
				→ 7M-3-515799; + ESP		03.2125-9604.3 010581	Ø 25,4	
SEAT - ALHAMBRA VAN (711) 06/10→06/23								
 Hauptbremszylinder								
TDI	85 - 135	10/14→12/22		für Linkslenker		03.4153-0186.3 010816	ATE Ø 23,8	
TDI 4Drive	110	05/15→12/22		für Rechtslenker		24.4153-0222.3 011047	ATE Ø 23,8 ohne Bremsflüssigkeitsbehälter	
TSi	110	05/15→12/22						
SEAT - ALTEA (5P1) 03/04→								
 Bremskraftverstärker								
1.2 TSI	77	04/10→		05/10→; für Linkslenker		03.7863-3232.4 300307	ATE Ø 10" pneumatisch	
1.4 16V	63	05/06→				03.7863-3332.4 300308	ATE Ø 10" pneumatisch	
1.4 TSI	92	11/07→						
1.6 LPG	75	09/09→		→ 04/10; für Linkslenker; +PR 1AC / 1AT		03.7863-3232.4 300307	ATE Ø 10" pneumatisch	











	kw				! #		
SEAT - ALTEA (5P1) 03/04→							
Bremskraftverstärker							
1.6 TDI	77	10/09→		05/10→; für Linkslenker	03.7863-3232.4	300307	ATE Ø 10" pneumatisch
1.8 TFSI	118	01/07→			03.7863-3332.4	300308	ATE Ø 10" pneumatisch
1.9 TDI	66 - 77	04/04→		→ 04/10; für Linkslenker; +PR 1AC / 1AT	03.7863-3232.4	300307	ATE Ø 10" pneumatisch
2.0 TDI	103 - 125	11/05→					
2.0 TDI 16V	103	03/04→					
1.6	75	03/04→03/10		+PR 1AC / 1AT; für Linkslenker	03.7863-3232.4	300307	ATE Ø 10" pneumatisch
2.0 FSI	110	05/04→03/09					
2.0 TDI	100	03/04→05/09					
2.0 TFSI	147	04/06→05/09					
1.6 Multifuel	75	11/10→05/11		für Linkslenker	03.7863-3232.4	300307	ATE Ø 10" pneumatisch
1.6 TDI	66	11/10→			03.7863-3332.4	300308	ATE Ø 10" pneumatisch
Hauptbremszylinder							
1.2 TSI	77	04/10→		→ 04/10; für Linkslenker	03.2122-2129.3	010799	ATE Ø 22,2
1.4 TSI	92	11/07→			03.2122-2129.3	010799	ATE Ø 22,2
1.6 LPG	75	09/09→		05/10→; +PR 1AC / 1AT / 1AS; für Linkslenker	03.2122-2129.3	010799	ATE Ø 22,2
1.6 TDI	77	10/09→					
1.8 TFSI	118	01/07→		05/10→; +PR 1AC / 1AT / 1LJ; für Linkslenker	03.2123-3449.3	010808	ATE Ø 23,8
1.9 TDI	66 - 77	04/04→					
2.0 TDI	103 - 125	11/05→		→ 04/10; für Rechtslenker	24.2122-1981.3	011024	ATE Ø 22,2 ohne Bremsflüssigkeitsbehälter
2.0 TDI 16V	103	03/04→			24.4152-0132.3	011025	ATE Ø 22,2 ohne Bremsflüssigkeitsbehälter
				05/10→; für Rechtslenker; +PR 1AC / 1AT / 1AS / 1ZD / 1LJ / 1LV	24.4152-0132.3	011025	ATE Ø 22,2 ohne Bremsflüssigkeitsbehälter
				05/10→; für Rechtslenker	24.4153-0202.3	011027	ATE Ø 23,8 ohne Bremsflüssigkeitsbehälter
1.4 16V	63	05/06→		→ 04/10; für Linkslenker	03.2122-2129.3	010799	ATE Ø 22,2
				05/10→; +PR 1AC / 1AT / 1AS; für Linkslenker	03.2122-2129.3	010799	ATE Ø 22,2
				05/10→; +PR 1AC / 1AT / 1LJ; für Linkslenker	03.2123-3449.3	010808	ATE Ø 23,8
				→ 04/10; für Rechtslenker	24.2122-1981.3	011024	ATE Ø 22,2 ohne Bremsflüssigkeitsbehälter
					24.4152-0132.3	011025	ATE Ø 22,2 ohne Bremsflüssigkeitsbehälter
				05/10→; +PR 1LJ / 1LV / 1AC / 1AT / 1AS / 1ZD; für Rechtslenker	24.4152-0132.3	011025	ATE Ø 22,2 ohne Bremsflüssigkeitsbehälter
				05/10→; für Rechtslenker	24.4153-0202.3	011027	ATE Ø 23,8 ohne Bremsflüssigkeitsbehälter
1.6	75	03/04→03/10		für Linkslenker	03.2122-2129.3	010799	ATE Ø 22,2
				für Linkslenker; +PR 1AC / 1AT / 1LJ	03.2123-3449.3	010808	ATE Ø 23,8
				für Rechtslenker	24.2122-1981.3	011024	ATE Ø 22,2 ohne Bremsflüssigkeitsbehälter
					24.4152-0132.3	011025	ATE Ø 22,2 ohne Bremsflüssigkeitsbehälter
					24.4153-0202.3	011027	ATE Ø 23,8 ohne Bremsflüssigkeitsbehälter
				+PR 1AC / 1AT / 1AS / 1ZD / 1LJ / 1LV; für Rechtslenker	24.4152-0132.3	011025	ATE Ø 22,2 ohne Bremsflüssigkeitsbehälter
1.6 Multifuel	75	11/10→05/11		für Linkslenker; +PR 1AC / 1AT / 1AS	03.2122-2129.3	010799	ATE Ø 22,2
1.6 TDI	66	11/10→		für Linkslenker; +PR 1AC / 1AT / 1LJ	03.2123-3449.3	010808	ATE Ø 23,8
				+PR 1AC / 1AT / 1AS / 1ZD / 1LJ / 1LV; für Rechtslenker	24.4152-0132.3	011025	ATE Ø 22,2 ohne Bremsflüssigkeitsbehälter
				für Rechtslenker	24.4153-0202.3	011027	ATE Ø 23,8 ohne Bremsflüssigkeitsbehälter
2.0 FSI	110	05/04→03/09		für Linkslenker	03.2122-2129.3	010799	ATE Ø 22,2
				für Rechtslenker	24.2122-1981.3	011024	ATE Ø 22,2 ohne Bremsflüssigkeitsbehälter
					24.4152-0132.3	011025	ATE Ø 22,2 ohne Bremsflüssigkeitsbehälter
2.0 TDI	100	03/04→05/09		für Linkslenker	03.2122-2129.3	010799	ATE Ø 22,2
2.0 TFSI	147	04/06→05/09		für Rechtslenker	24.2122-1981.3	011024	ATE Ø 22,2 ohne Bremsflüssigkeitsbehälter
					24.4153-0202.3	011027	ATE Ø 23,8 ohne Bremsflüssigkeitsbehälter
				+PR 1AC / 1AT / 1AS / 1ZD / 1LJ / 1LV; für Rechtslenker	24.4152-0132.3	011025	ATE Ø 22,2 ohne Bremsflüssigkeitsbehälter
→							















	kw			 	! #		
SEAT - ALTEA (5P1) 03/04 →							
Drucksensor, Bremskraftverstärker							
1.2 TSI	77	04/10 →		→ 04/10; +PR 1AS; für Linkslenker		03.0655-0101.2 370008	ATE
1.4 16V	63	05/06 →					
1.4 TSI	92	11/07 →					
1.6 LPG	75	09/09 →					
1.6 TDI	77	10/09 →					
1.8 TFSI	118	01/07 →					
1.9 TDI	66 - 77	04/04 →					
2.0 TDI	103 - 125	11/05 →					
2.0 TDI 16V	103	03/04 →					
1.6	75	03/04 → 03/10		+PR 1AS; für Linkslenker		03.0655-0101.2 370008	ATE
2.0 FSI	110	05/04 → 03/09					
2.0 TDI	100	03/04 → 05/09					
2.0 TFSI	147	04/06 → 05/09					
SEAT - ALTEA XL (5P5, 5P8) 10/06 →							
Bremskraftverstärker							
1.2 TSI	77	04/10 →		05/10 →; für Linkslenker		03.7863-3232.4 300307	ATE Ø 10" pneumatisch
1.4 TSI	92	11/07 →				03.7863-3332.4 300308	ATE Ø 10" pneumatisch
1.6	75	10/06 →					
1.6 LPG	75	09/09 →		+PR 1AC / 1AT; → 04/10; für Linkslenker		03.7863-3232.4 300307	ATE Ø 10" pneumatisch
1.6 Multifuel	75	10/06 → 11/10					
1.6 TDI	77	10/09 →					
1.8 TFSI	118	01/07 →					
1.9 TDI	66 - 77	10/06 → 12/10					
1.9 TDI 4x4	77	06/09 → 12/10					
2.0 TDI	103	10/06 →					
2.0 TDI 16V	103	10/06 →					
2.0 TDI 4x4	103	06/07 →					
1.4 16V	63	10/06 →		05/10 →; für Linkslenker		03.7863-3232.4 300307	ATE Ø 10" pneumatisch
						03.7863-3332.4 300308	ATE Ø 10" pneumatisch
				05/08 →; +PR 1AC / 1AT; → 04/10; für Linkslenker		03.7863-3232.4 300307	ATE Ø 10" pneumatisch
1.6 TDI	66	11/10 →		für Linkslenker		03.7863-3232.4 300307	ATE Ø 10" pneumatisch
2.0 TDI 16V 4x4	103	10/10 →				03.7863-3332.4 300308	ATE Ø 10" pneumatisch
2.0 TFSI	155	05/09 →					
2.0 TFSI 4x4	155	05/09 →					
2.0 FSI	110	10/06 → 03/09		+PR 1AC / 1AT; für Linkslenker		03.7863-3232.4 300307	ATE Ø 10" pneumatisch
2.0 TDI	100 - 125	11/06 → 12/13					
2.0 TDI 4x4	125	06/07 → 06/13					
2.0 TFSI	147	10/06 → 05/09					
2.0 TFSI 4x4	147	06/07 → 05/09					
Hauptbremszylinder							
1.2 TSI	77	04/10 →		→ 04/10; für Linkslenker		03.2122-2129.3 010799	ATE Ø 22,2
1.4 TSI	92	11/07 →					
1.6	75	10/06 →		05/10 →; +PR 1AC / 1AT / 1AS; für Linkslenker		03.2122-2129.3 010799	ATE Ø 22,2
1.6 LPG	75	09/09 →					
1.6 Multifuel	75	10/06 → 11/10		05/10 →; +PR 1AC / 1AT / 1LJ; für Linkslenker		03.2123-3449.3 010808	ATE Ø 23,8
1.6 TDI	77	10/09 →					
1.8 TFSI	118	01/07 →		→ 04/10; für Rechtslenker		24.2122-1981.3 011024	ATE Ø 22,2 ohne Bremsflüssigkeitsbehälter
1.9 TDI	66 - 77	10/06 → 12/10				24.4152-0132.3 011025	ATE Ø 22,2 ohne Bremsflüssigkeitsbehälter
2.0 TDI	103	10/06 →					
2.0 TDI 16V	103	10/06 →					
2.0 TDI 4x4	103	06/07 →		05/10 →; +PR 1AC / 1AT / 1AS / 1ZD / 1LJ / 1LV; für Rechtslenker		24.4152-0132.3 011025	ATE Ø 22,2 ohne Bremsflüssigkeitsbehälter
2.0 TFSI	155	05/09 →					
2.0 TFSI 4x4	155	05/09 →		05/10 →; für Rechtslenker		24.4153-0202.3 011027	ATE Ø 23,8 ohne Bremsflüssigkeitsbehälter
1.4 16V	63	10/06 →		05/10 →; +PR 1AC / 1AT / 1AS; für Linkslenker		03.2122-2129.3 010799	ATE Ø 22,2
				05/08 → 04/10; für Linkslenker		03.2122-2129.3 010799	ATE Ø 22,2
				05/10 →; +PR 1AC / 1AT / 1LJ; für Linkslenker		03.2123-3449.3 010808	ATE Ø 23,8
				05/08 → 04/10; für Rechtslenker		24.2122-1981.3 011024	ATE Ø 22,2 ohne Bremsflüssigkeitsbehälter
						24.4152-0132.3 011025	ATE Ø 22,2 ohne Bremsflüssigkeitsbehälter
				05/10 →; +PR 1AC / 1AT / 1AS / 1ZD / 1LJ / 1LV; für Rechtslenker		24.4152-0132.3 011025	ATE Ø 22,2 ohne Bremsflüssigkeitsbehälter
				05/10 →; für Rechtslenker		24.4153-0202.3 011027	ATE Ø 23,8 ohne Bremsflüssigkeitsbehälter
1.6 TDI	66	11/10 →		für Linkslenker; +PR 1AC / 1AT / 1AS		03.2122-2129.3 010799	ATE Ø 22,2
2.0 TDI 16V 4x4	103	10/10 →		für Linkslenker; +PR 1AC / 1AT / 1LJ		03.2123-3449.3 010808	ATE Ø 23,8
→							







	kw					! #		
SEAT - ALTEA XL (5P5, 5P8) 10/06→								
 Hauptbremszylinder								
1.6 TDI 2.0 TDI 16V 4x4	66 103	11/10→ 10/10→		+PR 1AC / 1AT / 1AS / 1ZD / 1LJ / 1LV; für Rechtslenker		24.4152-0132.3	011025	ATE Ø 22,2 ohne Bremsflüssigkeitsbehälter
				für Rechtslenker		24.4153-0202.3	011027	ATE Ø 23,8 ohne Bremsflüssigkeitsbehälter
1.9 TDI 4x4	77	06/09→12/10		→ 04/10; für Linkslenker		03.2122-2129.3	010799	ATE Ø 22,2
				05/10→; +PR 1AC / 1AT / 1AS; für Linkslenker		03.2122-2129.3	010799	ATE Ø 22,2
				→ 04/10; für Rechtslenker		24.2122-1981.3	011024	ATE Ø 22,2 ohne Bremsflüssigkeitsbehälter
						24.4152-0132.3	011025	ATE Ø 22,2 ohne Bremsflüssigkeitsbehälter
				05/10→; +PR 1AC / 1AT / 1AS / 1ZD / 1LJ / 1LV; für Rechtslenker		24.4152-0132.3	011025	ATE Ø 22,2 ohne Bremsflüssigkeitsbehälter
				05/10→; für Rechtslenker		24.4153-0202.3	011027	ATE Ø 23,8 ohne Bremsflüssigkeitsbehälter
2.0 FSI 2.0 TDI 2.0 TFSI 4x4	110 100 147	10/06→03/09 11/06→03/09 06/07→05/09		für Linkslenker		03.2122-2129.3	010799	ATE Ø 22,2
				für Rechtslenker		24.2122-1981.3	011024	ATE Ø 22,2 ohne Bremsflüssigkeitsbehälter
						24.4153-0202.3	011027	ATE Ø 23,8 ohne Bremsflüssigkeitsbehälter
				+PR 1AC / 1AT / 1AS / 1ZD / 1LJ / 1LV; für Rechtslenker		24.4152-0132.3	011025	ATE Ø 22,2 ohne Bremsflüssigkeitsbehälter
2.0 TDI 2.0 TDI 4x4	125 125	06/07→12/13 06/07→06/13		für Linkslenker		03.2122-2129.3	010799	ATE Ø 22,2
				für Rechtslenker		24.2122-1981.3	011024	ATE Ø 22,2 ohne Bremsflüssigkeitsbehälter
						24.4152-0132.3	011025	ATE Ø 22,2 ohne Bremsflüssigkeitsbehälter
2.0 TFSI	147	10/06→05/09		für Linkslenker		03.2122-2129.3	010799	ATE Ø 22,2
				für Rechtslenker		24.2122-1981.3	011024	ATE Ø 22,2 ohne Bremsflüssigkeitsbehälter
				+PR 1AC / 1AT / 1AS / 1ZD / 1LJ / 1LV; für Rechtslenker		24.4152-0132.3	011025	ATE Ø 22,2 ohne Bremsflüssigkeitsbehälter
Drucksensor, Bremskraftverstärker								
1.2 TSI 1.4 TSI 1.6 1.6 LPG 1.6 Multifuel 1.6 TDI 1.8 TFSI 1.9 TDI	77 92 75 75 75 77 118 66 - 77	04/10→ 11/07→ 10/06→ 09/09→ 10/06→11/10 10/09→ 01/07→ 10/06→12/10		+PR 1AS; → 04/10; für Linkslenker		03.0655-0101.2	370008	ATE
1.9 TDI 4x4 2.0 TDI 2.0 TDI 16V 2.0 TDI 4x4	77 103 103 103	06/09→12/10 10/06→ 10/06→ 06/07→						
1.4 16V	63	10/06→		05/08→; +PR 1AS; → 04/10; für Linkslenker		03.0655-0101.2	370008	ATE
2.0 FSI 2.0 TDI 2.0 TDI 4x4 2.0 TFSI 2.0 TFSI 4x4	110 100 - 125 147 - 155 147 - 155	10/06→03/09 11/06→12/13 06/07→06/13 10/06→ 06/07→		+PR 1AS; für Linkslenker		03.0655-0101.2	370008	ATE
SEAT - AROSA (6H1) 05/97→06/04								
 Hauptbremszylinder								
1.0 1.4 1.4 16V 1.4 TDI	37 44 74 55	05/97→06/04 05/97→06/04 01/00→06/04 01/00→06/04		für Linkslenker; - ABS		03.2120-3943.3	010532	ATE Ø 20,6
				für Linkslenker; + ABS		03.2122-1344.3	010593	ATE Ø 22,2
1.7 SDI	44	08/97→06/04		11/97→; für Linkslenker; - ABS		03.2120-3943.3	010532	ATE Ø 20,6
				11/97→; für Linkslenker; + ABS		03.2122-1344.3	010593	ATE Ø 22,2
SEAT - ATECA (KH7, KHP) 04/16→								
 Hauptbremszylinder								
1.4 TSI 4Drive 1.5 TSI 4Drive 2.0 TDI 4Drive →	110 110 140	06/16→ 07/18→ 06/16→		für Linkslenker		24.4123-1719.3	011017	TRW Ø 23,8 ohne Bremsflüssigkeitsbehälter











	kw					! #		
SEAT - ATECA (KH7, KHP) 04/16→								
 Hauptbremszylinder								
2.0 TSI 4Drive	140	05/17→		für Linkslenker		24.4153-1522.3	011048	ATE Ø 23,8 ohne Bremsflüssigkeitsbehälter
2.0 TDI 4Drive	110	04/16→		06/16→; für Linkslenker		24.4123-1719.3	011017	TRW Ø 23,8 ohne Bremsflüssigkeitsbehälter
				für Linkslenker		24.4153-1522.3	011048	ATE Ø 23,8 ohne Bremsflüssigkeitsbehälter
SEAT - CORDOBA (6K1, 6K2) 02/93→12/02								
 Bremskraftverstärker								
1.0	51	06/01→08/02		für Linkslenker; - ABS		03.7750-6302.4	300161	ATE Ø 9" pneumatisch
				+ ABS; für Linkslenker; +PR 1KB		10.6350-3902.4	300213	ATE Ø 9" pneumatisch
				+ ABS; für Linkslenker; +PR 1KK / 1KM / 1KQ		10.6350-4002.4	300285	ATE Ø 9" pneumatisch
1.0 i	37	09/96→10/02		06/99→ 09/02; für Linkslenker; - ABS		03.7750-6302.4	300161	ATE Ø 9" pneumatisch
			1.4 i	44	06/94→10/02		06/99→ 09/02; für Linkslenker; + ABS; +PR 1KB	
1.4 i 16V	74	09/96→10/02		06/99→ 09/02; für Linkslenker; + ABS; +PR 1KB		10.6350-4002.4	300285	ATE Ø 9" pneumatisch
1.6 i	55 - 74	02/93→10/02		06/99→ 09/02; für Linkslenker; + ABS; +PR 1KK / 1KM / 1KQ		10.6350-4002.4	300285	ATE Ø 9" pneumatisch
1.9 TDI	66 - 81	08/96→10/02		→ 09/02; für Linkslenker; - ABS		03.7750-6302.4	300161	ATE Ø 9" pneumatisch
1.4 16V	115	07/00→10/02		→ 09/02; für Linkslenker; + ABS; +PR 1KB		10.6350-3902.4	300213	ATE Ø 9" pneumatisch
			1.8 T 20V Cupra	50	06/99→10/02		→ 09/02; für Linkslenker; + ABS; +PR 1KK / 1KM / 1KQ	
1.9 SDI	50	06/99→10/02		→ 09/02; für Linkslenker; + ABS; +PR 1KK / 1KM / 1KQ		10.6350-4002.4	300285	ATE Ø 9" pneumatisch
 Hauptbremszylinder								
1.0	51	06/01→08/02		für Linkslenker; - ABS		03.2122-1042.3	010137	Ø 22,2
				für Linkslenker; + ABS		03.2123-1424.3	010637	ATE Ø 23,8
1.0 i	37	09/96→10/02		06/99→ 09/02; für Linkslenker; - ABS		03.2122-1042.3	010137	Ø 22,2
				06/99→ 09/02; für Linkslenker; + ABS		03.2123-1424.3	010637	ATE Ø 23,8
1.4	40	12/97→04/99		- ABS		03.2120-3943.3	010532	ATE Ø 20,6
1.4 16V	55	05/00→10/02		→ 09/02; für Linkslenker; - ABS		03.2122-1042.3	010137	Ø 22,2
			1.8 T 20V Cupra	115	07/00→10/02		→ 09/02; für Linkslenker; + ABS	
1.9 SDI	50	06/99→10/02		→ 09/02; für Linkslenker; + ABS		03.2123-1424.3	010637	ATE Ø 23,8
1.4 i	44	06/94→10/02		→ 05/99; - ABS		03.2120-3943.3	010532	ATE Ø 20,6
1.4 i 16V	74	09/96→10/02		06/99→ 09/02; für Linkslenker; - ABS		03.2122-1042.3	010137	Ø 22,2
			1.6 i	74	07/96→10/02		06/99→ 09/02; für Linkslenker; + ABS	
1.6 i	55	02/93→10/02		11/93→ 05/99; - ABS		03.2120-3943.3	010532	ATE Ø 20,6
				06/99→ 09/02; für Linkslenker; - ABS		03.2122-1042.3	010137	Ø 22,2
				06/99→ 09/02; für Linkslenker; + ABS		03.2123-1424.3	010637	ATE Ø 23,8
1.6 i	55	05/94→06/99		→ 05/99; - ABS		03.2120-3943.3	010532	ATE Ø 20,6
			1.9 SDI	47	08/96→06/99		→ 05/99; - ABS	
1.8 i	66	02/93→09/02		11/93→ 05/99; - ABS		03.2120-3943.3	010532	ATE Ø 20,6
1.9 TDI	66 - 81	08/96→10/02		06/99→ 09/02; für Linkslenker; - ABS		03.2122-1042.3	010137	Ø 22,2
				→ 05/99; - ABS		03.2122-1042.3	010137	Ø 22,2
				06/99→ 09/02; für Linkslenker; + ABS		03.2123-1424.3	010637	ATE Ø 23,8
2.0 i	85	02/93→06/99		11/93→ 05/99; - ABS		03.2122-1042.3	010137	Ø 22,2
				11/93→ 05/99; für Linkslenker; + ABS		10.6123-0674.3	010639	ATE Ø 23,8
Verschlusschraube, Hauptbremszylinder								
1.4	40	12/97→04/99		- ABS		03.3517-0101.2	390322	
1.4 i	44	06/94→10/02		→ 05/99; - ABS		03.3517-0101.2	390322	
			1.4 i 16V	74	09/96→10/02		→ 05/99; - ABS	
1.6 i	55 - 74	05/94→10/02						
			1.9 SDI	47	08/96→06/99			
1.9 TDI	66 - 81	08/96→10/02						
1.6 i	55	02/93→10/02		11/93→ 05/99; - ABS		03.3517-0101.2	390322	
1.8 i	66	02/93→09/02						
2.0 i	85	02/93→06/99						
SEAT - CORDOBA (6L2) 09/02→11/09								
 Bremskraftverstärker								
1.2	47	10/02→06/06		für Linkslenker		03.7750-6302.4	300161	ATE Ø 9" pneumatisch
1.4 TDI	55	10/02→12/05						
1.2 12V	51	05/06→11/09		→ 06/09; für Linkslenker		03.7750-6302.4	300161	ATE Ø 9" pneumatisch
1.4 16V	63 - 74	10/02→11/09						

























	kw				! #		
SEAT - CORDOBA (6L2) 09/02→11/09							
 Bremskraftverstärker							
1.4 TDI	51 - 59	05/05→11/09		→ 06/09; für Linkslenker		03.7750-6302.4 300161	ATE Ø 9" pneumatisch
1.6	74	04/03→11/09					
1.6 16V	77	11/06→11/09					
1.9 TDI	96	10/02→11/09					
1.4 16V	55	09/02→12/07		10/02→; für Linkslenker		03.7750-6302.4 300161	ATE Ø 9" pneumatisch
1.9 SDI	47	09/02→11/09		10/02→ 06/09; für Linkslenker		03.7750-6302.4 300161	ATE Ø 9" pneumatisch
1.9 TDI	74	09/02→11/09					
2.0	85	09/02→11/09					
 Hauptbremszylinder							
1.2	47	10/02→06/06		+ ABS		24.2120-1734.3 010702	Ø 20,6
1.4 TDI	55	10/02→12/05		- ABS		24.2120-1736.3 010732	Ø 20,6
1.2 12V	51	05/06→11/09		→ 06/09; + ABS		24.2120-1734.3 010702	Ø 20,6
1.4 16V	63 - 74	10/02→11/09		→ 06/09; - ABS		24.2120-1736.3 010732	Ø 20,6
1.4 TDI	51 - 59	05/05→11/09					
1.6	74	04/03→11/09					
1.6 16V	77	11/06→11/09					
1.9 TDI	96	10/02→11/09					
1.4 16V	55	09/02→12/07		10/02→; + ABS		24.2120-1734.3 010702	Ø 20,6
				10/02→; - ABS		24.2120-1736.3 010732	Ø 20,6
1.9 SDI	47	09/02→11/09		10/02→ 06/09; + ABS		24.2120-1734.3 010702	Ø 20,6
1.9 TDI	74	09/02→11/09		10/02→ 06/09; - ABS		24.2120-1736.3 010732	Ø 20,6
2.0	85	09/02→11/09					
 Bremskraftregler							
1.2	47	10/02→06/06		- ABS		03.6583-0216.3 320247	ATE lastabhängig 8/3 4x
1.4 TDI	55	10/02→12/05					
1.2 12V	51	05/06→11/09		→ 06/09; - ABS		03.6583-0216.3 320247	ATE lastabhängig 8/3 4x
1.4 16V	63 - 74	10/02→11/09					
1.4 TDI	51 - 59	05/05→11/09					
1.6	74	04/03→11/09					
1.6 16V	77	11/06→11/09					
1.9 TDI	96	10/02→11/09					
1.4 16V	55	09/02→12/07		10/02→; - ABS		03.6583-0216.3 320247	ATE lastabhängig 8/3 4x
1.9 SDI	47	09/02→11/09		10/02→ 06/09; - ABS		03.6583-0216.3 320247	ATE lastabhängig 8/3 4x
1.9 TDI	74	09/02→11/09					
2.0	85	09/02→11/09					
SEAT - CORDOBA Vario (6K5) 07/96→12/02							
 Bremskraftverstärker							
1.4	74	02/00→07/00		für Linkslenker; - ABS		03.7750-6302.4 300161	ATE Ø 9" pneumatisch
				für Linkslenker; + ABS; +PR 1KB		10.6350-3902.4 300213	ATE Ø 9" pneumatisch
				für Linkslenker; + ABS; +PR 1KK / 1KM / 1KQ		10.6350-4002.4 300285	ATE Ø 9" pneumatisch
1.4 16V	55	06/99→12/02		→ 09/02; für Linkslenker; - ABS		03.7750-6302.4 300161	ATE Ø 9" pneumatisch
1.9 SDI	50	06/99→12/02		→ 09/02; für Linkslenker; + ABS; +PR 1KB		10.6350-3902.4 300213	ATE Ø 9" pneumatisch
				→ 09/02; für Linkslenker; + ABS; +PR 1KK / 1KM / 1KQ		10.6350-4002.4 300285	ATE Ø 9" pneumatisch
1.4 i	44	09/96→12/02		06/99→ 09/02; für Linkslenker; - ABS		03.7750-6302.4 300161	ATE Ø 9" pneumatisch
1.6 i	55 - 74	09/96→12/02		06/99→ 09/02; für Linkslenker; + ABS; +PR 1KB		10.6350-3902.4 300213	ATE Ø 9" pneumatisch
1.9 TDI	66 - 81	08/96→12/02		06/99→ 09/02; für Linkslenker; + ABS; +PR 1KK / 1KM / 1KQ		10.6350-4002.4 300285	ATE Ø 9" pneumatisch
 Hauptbremszylinder							
1.4	74	02/00→07/00		- ABS		03.2120-3943.3 010532	ATE Ø 20,6
				für Linkslenker; - ABS		03.2122-1042.3 010137	Ø 22,2
				für Linkslenker; + ABS		03.2123-1424.3 010637	ATE Ø 23,8
1.4 16V	55	06/99→12/02		→ 09/02; für Linkslenker; - ABS		03.2122-1042.3 010137	Ø 22,2
1.9 SDI	50	06/99→12/02		→ 09/02; für Linkslenker; + ABS		03.2123-1424.3 010637	ATE Ø 23,8
1.4 i	44	09/96→12/02		→ 05/99; - ABS		03.2120-3943.3 010532	ATE Ø 20,6
1.6 i	55 - 74	09/96→12/02		06/99→ 09/02; für Linkslenker; - ABS		03.2122-1042.3 010137	Ø 22,2
				06/99→ 09/02; für Linkslenker; + ABS		03.2123-1424.3 010637	ATE Ø 23,8
1.6 i	55	05/97→06/99		→ 05/99; - ABS		03.2120-3943.3 010532	ATE Ø 20,6
1.9 SDI	47	09/96→06/99					
→							

	kw			 	! #		
SEAT - CORDOBA Vario (6K5) 07/96→12/02							
 Hauptbremszylinder							
1.9 TDI	66 - 81	08/96→12/02		06/99→ 09/02; für Linkslenker; - ABS	03.2122-1042.3 010137		Ø 22,2
				→ 05/99; - ABS	03.2122-1042.3 010137		Ø 22,2
				06/99→ 09/02; für Linkslenker; + ABS	03.2123-1424.3 010637		ATE Ø 23,8
Verschlusschraube, Hauptbremszylinder							
1.4	74	02/00→07/00		- ABS	03.3517-0101.2 390322		
1.4 i	44	09/96→12/02		→ 05/99; - ABS	03.3517-0101.2 390322		
1.6 i	55 - 74	09/96→12/02					
1.9 SDI	47	09/96→06/99					
1.9 TDI	66 - 81	08/96→12/02					
SEAT - CORDOBA VARIO Kasten/Kombi (6K5) 08/00→12/02							
 Bremskraftverstärker							
1.9 TDI	81	08/00→12/02		→ 09/02; für Linkslenker; - ABS	03.7750-6302.4 300161		ATE Ø 9" pneumatisch
				→ 09/02; für Linkslenker; + ABS; +PR 1KB	10.6350-3902.4 300213		ATE Ø 9" pneumatisch
				→ 09/02; für Linkslenker; + ABS; +PR 1KK / 1KM / 1KQ	10.6350-4002.4 300285		ATE Ø 9" pneumatisch
 Hauptbremszylinder							
1.9 TDI	81	08/00→12/02		→ 09/02; für Linkslenker; - ABS	03.2122-1042.3 010137		Ø 22,2
				→ 09/02; für Linkslenker; + ABS	03.2123-1424.3 010637		ATE Ø 23,8
SEAT - EXEO (3R2) 12/08→05/13							
 Bremskraftverstärker							
1.6	75	03/09→09/10		04/09→	03.7858-4502.4 300202		ATE Ø 9 / 8" pneumatisch
1.8 T	110	12/08→05/10					
2.0 TDI	88 - 125	12/08→05/13					
2.0 TFSI	147	03/09→05/13					
1.8 TSI	88 - 118	05/10→05/13			03.7858-4502.4 300202		ATE Ø 9 / 8" pneumatisch
2.0 TFSI	155	05/10→05/13					
 Hauptbremszylinder							
1.6	75	03/09→09/10		04/09→	03.2125-0373.3 010810		ATE Ø 25,4
1.8 T	110	12/08→05/10					
2.0 TDI	88 - 125	12/08→05/13			24.2125-1720.3 010688		TRW Ø 25,4
2.0 TFSI	147	03/09→05/13					
1.8 TSI	88 - 118	05/10→05/13			03.2125-0373.3 010810		ATE Ø 25,4
2.0 TFSI	155	05/10→05/13			24.2125-1720.3 010688		TRW Ø 25,4
SEAT - EXEO ST (3R5) 05/09→05/13							
 Bremskraftverstärker							
1.6	75	06/09→09/10			03.7858-4502.4 300202		ATE Ø 9 / 8" pneumatisch
1.8 T	110	06/09→05/10					
1.8 TSI	88 - 118	05/10→05/13					
2.0 TDI	88 - 125	05/09→05/13					
2.0 TFSI	147 - 155	06/09→05/13					
 Hauptbremszylinder							
1.6	75	06/09→09/10			03.2125-0373.3 010810		ATE Ø 25,4
1.8 T	110	06/09→05/10					
1.8 TSI	88 - 118	05/10→05/13			24.2125-1720.3 010688		TRW Ø 25,4
2.0 TDI	88 - 125	05/09→05/13					
2.0 TFSI	147 - 155	06/09→05/13					
SEAT - IBIZA II (6K1) 03/93→05/02							
 Bremskraftverstärker							
1.0 16V	51	10/99→02/02		→ 01/02; für Linkslenker; - ABS	03.7750-6302.4 300161		ATE Ø 9" pneumatisch
1.4 16V	55	05/00→02/02					
1.8 T 20V Cupra	115	07/00→02/02		→ 01/02; für Linkslenker; +PR 0G1 / 0G3 / 1KB; Schaltgetriebe	10.6350-3902.4 300213		ATE Ø 9" pneumatisch
1.8 T 20V Cupra R	132	07/00→02/02					
→							







	kw			 	! #		
SEAT - IBIZA II (6K1) 03/93→05/02							
Bremskraftverstärker							
1.9 SDI	50	08/99→02/02		→ 01/02; für Linkslenker; +PR 0G4; Schaltgetriebe		10.6350-4002.4 300285	ATE Ø 9" pneumatisch
				→ 01/02; für Linkslenker; +PR 1KM / 1KK / 1KQ / 1ZK / 1KB; Automatikgetriebe		10.6350-4002.4 300285	ATE Ø 9" pneumatisch
1.0 i	37	09/96→02/02		08/99→ 01/02; für Linkslenker; - ABS		03.7750-6302.4 300161	ATE Ø 9" pneumatisch
1.4 i	44	09/93→02/02		08/99→ 01/02; für Linkslenker; +PR 0G1 / 0G3 / 1KB; Schaltgetriebe		10.6350-3902.4 300213	ATE Ø 9" pneumatisch
1.4 i 16V	74	06/97→02/02					
1.9 TDI	66 - 81	08/96→02/02		6K-TR069487→; → 07/99; für Linkslenker		10.6350-3902.4 300213	ATE Ø 9" pneumatisch
				08/99→ 01/02; für Linkslenker; +PR 0G4; Schaltgetriebe		10.6350-4002.4 300285	ATE Ø 9" pneumatisch
				08/99→ 01/02; für Linkslenker; +PR 1KM / 1KK / 1KQ / 1ZK / 1KB; Automatikgetriebe		10.6350-4002.4 300285	ATE Ø 9" pneumatisch
				6K-TR069487→; → 07/99; für Linkslenker; + ABS		10.6350-4002.4 300285	ATE Ø 9" pneumatisch
1.3 i	40	03/93→08/99		6K-TR069487→; → 07/99; für Linkslenker		10.6350-3902.4 300213	ATE Ø 9" pneumatisch
2.0 i 16V	110	08/96→08/99		6K-TR069487→; → 07/99; für Linkslenker; + ABS		10.6350-4002.4 300285	ATE Ø 9" pneumatisch
1.4	40	12/97→04/99		6K-TR069487→; für Linkslenker		10.6350-3902.4 300213	ATE Ø 9" pneumatisch
				6K-TR069487→; für Linkslenker; + ABS		10.6350-4002.4 300285	ATE Ø 9" pneumatisch
1.6 i	55 - 74	03/93→02/02		08/99→ 01/02; für Linkslenker; - ABS		03.7750-6302.4 300161	ATE Ø 9" pneumatisch
				→ 07/99; für Linkslenker; - ABS		03.7750-6302.4 300161	ATE Ø 9" pneumatisch
				08/99→ 01/02; für Linkslenker; +PR 0G1 / 0G3 / 1KB; Schaltgetriebe		10.6350-3902.4 300213	ATE Ø 9" pneumatisch
				6K-TR069487→; → 07/99; für Linkslenker		10.6350-3902.4 300213	ATE Ø 9" pneumatisch
				08/99→ 01/02; für Linkslenker; +PR 1KM / 1KK / 1KQ / 1ZK / 1KB; Automatikgetriebe		10.6350-4002.4 300285	ATE Ø 9" pneumatisch
				08/99→ 01/02; für Linkslenker; +PR 0G4; Schaltgetriebe		10.6350-4002.4 300285	ATE Ø 9" pneumatisch
				6K-TR069487→; → 07/99; für Linkslenker; + ABS		10.6350-4002.4 300285	ATE Ø 9" pneumatisch
1.6 i	55	09/94→06/99		für Linkslenker; - ABS		03.7750-6302.4 300161	ATE Ø 9" pneumatisch
1.9 D	47	04/93→06/99		6K-TR069487→; für Linkslenker		10.6350-3902.4 300213	ATE Ø 9" pneumatisch
				6K-TR069487→; für Linkslenker; + ABS		10.6350-4002.4 300285	ATE Ø 9" pneumatisch
1.8 i	66	03/93→08/99		→ 07/99; für Linkslenker; - ABS		03.7750-6302.4 300161	ATE Ø 9" pneumatisch
1.9 SDI	47	08/96→08/99		6K-TR069487→; → 07/99; für Linkslenker		10.6350-3902.4 300213	ATE Ø 9" pneumatisch
2.0 i	85	03/93→08/99		6K-TR069487→; → 07/99; für Linkslenker; + ABS		10.6350-4002.4 300285	ATE Ø 9" pneumatisch
Hauptbremszylinder							
1.0 16V	51	10/99→02/02		→ 01/02; für Linkslenker; - ABS		03.2122-1042.3 010137	Ø 22,2
1.4 16V	55	05/00→02/02		→ 01/02; für Linkslenker; + ABS		03.2123-1424.3 010637	ATE Ø 23,8
1.8 T 20V Cupra	115	07/00→02/02					
1.8 T 20V Cupra R	132	07/00→02/02					
1.9 SDI	50	08/99→02/02					
1.0 i	37	09/96→02/02		→ 07/99; - ABS		03.2120-3943.3 010532	ATE Ø 20,6
1.4 i	44	09/93→02/02		08/99→ 01/02; für Linkslenker; - ABS		03.2122-1042.3 010137	Ø 22,2
1.6 i	55 - 74	03/93→02/02		08/99→ 01/02; für Linkslenker; + ABS		03.2123-1424.3 010637	ATE Ø 23,8
1.3 i	40	03/93→08/99		→ 07/99; - ABS		03.2120-3943.3 010532	ATE Ø 20,6
1.8 i	66	03/93→08/99					
1.9 SDI	47	08/96→08/99					
1.4	40	12/97→04/99		- ABS		03.2120-3943.3 010532	ATE Ø 20,6
1.6 i	55	09/94→06/99					
1.9 D	47	04/93→06/99					
1.4 i 16V	74	06/97→02/02		08/99→ 01/02; für Linkslenker; - ABS		03.2122-1042.3 010137	Ø 22,2
				08/99→ 01/02; für Linkslenker; + ABS		03.2123-1424.3 010637	ATE Ø 23,8
1.9 TDI	66	08/96→02/02		08/99→ 01/02; für Linkslenker; - ABS		03.2122-1042.3 010137	Ø 22,2
				→ 07/99; - ABS		03.2122-1042.3 010137	Ø 22,2
				08/99→ 01/02; für Linkslenker; + ABS		03.2123-1424.3 010637	ATE Ø 23,8
1.9 TDI	81	02/97→02/02		03/97→ 07/99; - ABS		03.2122-1042.3 010137	Ø 22,2
				08/99→ 01/02; für Linkslenker; - ABS		03.2122-1042.3 010137	Ø 22,2
				08/99→ 01/02; für Linkslenker; + ABS		03.2123-1424.3 010637	ATE Ø 23,8
2.0 i	85	03/93→08/99		→ 07/99; - ABS		03.2122-1042.3 010137	Ø 22,2
				→ 07/99; für Linkslenker; + ABS		10.6123-0674.3 010639	ATE Ø 23,8
→							









	kW			 	! #			
SEAT - IBIZA II (6K1) 03/93→05/02								
Verschlusschraube, Hauptbremszylinder								
1.0 i	37	09/96→02/02		→ 07/99; - ABS		03.3517-0101.2 390322		
1.3 i	40	03/93→08/99						
1.4 i	44	09/93→02/02						
1.6 i	55 - 74	03/93→02/02						
1.8 i	66	03/93→08/99						
1.9 SDI	47	08/96→08/99						
1.9 TDI	66	08/96→02/02						
2.0 i	85	03/93→08/99						
1.4	40	12/97→04/99		- ABS			03.3517-0101.2 390322	
1.6 i	55	09/94→06/99						
1.9 D	47	04/93→06/99						
1.9 TDI	81	02/97→02/02		03/97→ 07/99; - ABS		03.3517-0101.2 390322		
SEAT - IBIZA III (6L1) 02/02→11/09								
 Hauptbremszylinder								
1.2	44 - 47	02/02→05/08		+ ABS		24.2120-1734.3 010702	Ø 20,6	
1.2 12V	51	05/06→11/09		- ABS		24.2120-1736.3 010732	Ø 20,6	
1.4 16V	55 - 74	02/02→11/09						
1.4 TDI	51 - 59	05/02→11/09						
1.6	74	02/03→11/09						
1.6 16V	77	11/06→11/09						
1.8 T Cupra R	132	01/04→02/08						
1.8 T FR	110	12/03→05/08						
1.9 SDI	47	02/02→12/05						
1.9 TDI	74 - 96	02/02→11/09						
1.9 TDI Cupra R	118	03/04→02/08						
1.9 TDI Joya Racer	112	07/03→06/04						
2.0	85	04/02→11/09						
 Bremskraftregler								
1.2	44 - 47	02/02→05/08		- ABS		03.6583-0216.3 320247	ATE lastabhängig 8/3 4x	
1.2 12V	51	05/06→11/09						
1.4 16V	55 - 74	02/02→11/09						
1.4 TDI	51 - 59	05/02→11/09						
1.6	74	02/03→11/09						
1.6 16V	77	11/06→11/09						
1.8 T Cupra R	132	01/04→02/08						
1.8 T FR	110	12/03→05/08						
1.9 SDI	47	02/02→12/05						
1.9 TDI	74 - 96	02/02→11/09						
1.9 TDI Cupra R	118	03/04→02/08						
1.9 TDI Joya Racer	112	07/03→06/04						
2.0	85	04/02→11/09						
SEAT - IBIZA IV (6J5, 6P1) 03/08→12/17								
 Bremskraftregler								
1.0	55	05/15→06/17		- ABS		03.6583-0216.3 320247	ATE lastabhängig 8/3 4x	
1.0 TSI	70 - 81	05/15→06/17						
1.2	44	07/09→05/11						
1.2 TDI	55	06/10→05/15						
1.2 TSI	63 - 81	09/10→06/17						
1.4 TDI	55 - 77	07/08→06/17						
1.6	81	07/15→06/17						
1.6 LPG	60	05/11→05/15						
1.9 TDI	66	07/08→06/10						
1.2	51	03/08→05/15		07/08→; - ABS				03.6583-0216.3 320247
1.2 LPG	51	03/08→05/11						
1.4	63	03/08→05/15						
1.4 LPG	63	03/08→05/11						
1.6	77	05/08→03/12						
1.9 TDI	77	03/08→06/10						
SEAT - IBIZA IV Kasten/Schrägheck (6J1) 04/08→05/15								
 Bremskraftregler								
1.2	51	04/08→05/15		- ABS		03.6583-0216.3 320247	ATE lastabhängig 8/3 4x	
1.2 TDI	55	05/10→05/15						

	kW			 	! #		
SEAT - IBIZA IV SC (6J1, 6P5) 06/08→12/18							
 Bremskraftregler							
1.0 1.0 TSI	55 70 - 81	05/15→12/16 05/15→12/16		- ABS		03.6583-0216.3 320247	ATE lastabhängig 8/3 4x
1.2	44 - 51	07/08→05/15					
1.2 TDI	55	05/10→05/15					
1.2 TSI	63 - 81	09/10→12/16					
1.4	63	07/08→05/15					
1.4 LPG	63	07/08→05/11					
1.4 TDI	55 - 77	07/08→12/16					
1.6	77 - 81	07/08→12/16					
1.6 LPG	60	05/11→05/15					
1.9 TDI	66 - 77	06/08→06/10					
SEAT - IBIZA IV ST (6J8, 6P8) 03/10→07/16							
 Bremskraftregler							
1.0 1.0 TSI	55 70 - 81	05/15→07/16 05/15→07/16		- ABS		03.6583-0216.3 320247	ATE lastabhängig 8/3 4x
1.2	44 - 51	05/10→05/15					
1.2 TDI	55	04/10→05/15					
1.2 TSI	63 - 81	09/10→07/16					
1.4	63	03/10→05/15					
1.4 TDI	55 - 77	05/15→07/16					
1.6	77	02/12→05/15					
SEAT - IBIZA V (KJ1, KJG) 01/17→							
 Hauptbremszylinder							
1.0 1.0 MPi	48 - 55	01/17→		für Linkslenker; +PR 1ZE / 1ZQ		24.4123-1719.3 011017	TRW Ø 23,8 ohne Bremsflüssigkeitsbehälter
1.0 TGI	59	07/18→					
1.0 TSI	66 - 85	11/17→					
1.5 TSI	110	07/17→					
1.6	81	05/17→					
1.6 TDI	59 - 85	09/17→					
SEAT - INCA (6K9) 11/95→11/03							
 Bremskraftverstärker							
1.4 16V	55	04/00→06/03		für Linkslenker; - ABS		03.7750-6302.4 300161	ATE Ø 9" pneumatisch
1.4 i	44	11/95→06/03		für Linkslenker; + ABS		10.6350-4002.4 300285	ATE Ø 9" pneumatisch
1.6 i	55	06/97→09/00					
1.7 D	42	09/96→06/03					
1.9 D	47	11/95→06/03					
1.9 SDI	47	11/95→06/03					
1.9 TDI	66	09/96→06/03					
 Hauptbremszylinder							
1.4 16V	55	04/00→06/03		- ABS		03.2122-1042.3 010137	Ø 22,2
				+ ABS		03.2123-1424.3 010637	ATE Ø 23,8
						03.2123-1484.3 010595	ATE Ø 23,8
1.4 i	44	11/95→06/03		für Linkslenker; - ABS		03.2122-1042.3 010137	Ø 22,2
1.6 i	55	06/97→09/00					
1.7 D	42	09/96→06/03		→ 9K-X-006000; für Rechtslenker; - ABS		03.2122-1042.3 010137	Ø 22,2
1.9 D	47	11/95→06/03		für Linkslenker; + ABS		03.2123-1424.3 010637	ATE Ø 23,8
1.9 SDI	47	11/95→06/03					
1.9 TDI	66	09/96→06/03		für Rechtslenker; + ABS		03.2123-1484.3 010595	ATE Ø 23,8
Verschlusschraube, Hauptbremszylinder							
1.4 16V	55	04/00→06/03		- ABS		03.3517-0101.2 390322	
1.4 i	44	11/95→06/03		für Linkslenker; - ABS		03.3517-0101.2 390322	
1.6 i	55	06/97→09/00					
1.7 D	42	09/96→06/03		→ 9K-X-006000; für Rechtslenker; - ABS		03.3517-0101.2 390322	
1.9 D	47	11/95→06/03					
1.9 SDI	47	11/95→06/03					
1.9 TDI	66	09/96→06/03					

	kw			 	! #		
SEAT - LEON (1M1) 11/99→06/06							
 Bremskraftverstärker							
1.4 16V	55	11/99→06/06		1M-1R023639→; → 07/05; für Linkslenker; + ESP		03.7860-0602.4 300141	ATE Ø 10" pneumatisch
1.6	74	11/99→06/06					
1.6 16 V	77	09/00→06/06		1M-1B018342→; → 07/05; für Linkslenker; + ESP		03.7860-0602.4 300141	ATE Ø 10" pneumatisch
1.8 20V	92	11/99→06/06					
1.8 20V T	132	11/99→06/06		→ 1M-1R023638; für Linkslenker; + ESP		03.7863-0402.4 300124	ATE Ø 10" pneumatisch
1.8 20V T 4	132	11/99→06/06					
1.8 T Cupra R	165	07/03→06/06		→ 1M-1B018341; für Linkslenker; + ESP		03.7863-0402.4 300124	ATE Ø 10" pneumatisch
1.9 SDI	50	11/99→06/06					
1.9 TDI	66 - 96	11/99→06/06					
1.9 TDI Syncro	110	05/02→06/06					
2.8 Cupra 4	150	02/01→06/06					
1.6	75	10/05→06/06		→ 1M-1B018341; für Linkslenker; + ESP		03.7863-0402.4 300124	ATE Ø 10" pneumatisch
				→ 1M-1R023638; für Linkslenker; + ESP		03.7863-0402.4 300124	ATE Ø 10" pneumatisch
1.8 T Cupra R	154	02/02→06/06		1M-1B018342→; → 07/05; für Linkslenker; + ESP		03.7860-0602.4 300141	ATE Ø 10" pneumatisch
				1M-1R023639→; → 07/05; für Linkslenker; + ESP		03.7860-0602.4 300141	ATE Ø 10" pneumatisch
				05/02→; → 1M-1B018341; + ESP; für Linkslenker		03.7863-0402.4 300124	ATE Ø 10" pneumatisch
				05/02→; → 1M-1R023638; + ESP; für Linkslenker		03.7863-0402.4 300124	ATE Ø 10" pneumatisch
1.9 TDI	74	10/05→06/06		1M-1B018342→; für Linkslenker; + ESP		03.7860-0602.4 300141	ATE Ø 10" pneumatisch
2.8	150	05/02→06/04		1M-1R023639→; für Linkslenker; + ESP		03.7860-0602.4 300141	ATE Ø 10" pneumatisch
				→ 1M-1B018341; für Linkslenker; + ESP		03.7863-0402.4 300124	ATE Ø 10" pneumatisch
				→ 1M-1R023638; für Linkslenker; + ESP		03.7863-0402.4 300124	ATE Ø 10" pneumatisch
1.9 TDI	110	09/00→06/06		1M-1B018342→; → 07/05; für Linkslenker; + ESP		03.7860-0602.4 300141	ATE Ø 10" pneumatisch
				1M-1R023639→; → 07/05; für Linkslenker; + ESP		03.7860-0602.4 300141	ATE Ø 10" pneumatisch
				02/01→; → 1M-1B018341; für Linkslenker; + ESP		03.7863-0402.4 300124	ATE Ø 10" pneumatisch
				02/01→; → 1M-1R023638; für Linkslenker; + ESP		03.7863-0402.4 300124	ATE Ø 10" pneumatisch
 Hauptbremszylinder							
1.4 16V	55	11/99→06/06		→ 08/00; für Linkslenker; + ESP		03.2123-2024.3 010597	ATE Ø 23,8
1.6	74	11/99→06/06					
1.8 20V	92	11/99→06/06		09/00→ 07/05; für Linkslenker; + ESP		03.2123-2715.3 010802	ATE Ø 23,8
1.8 20V T	132	11/99→06/06		09/00→ 07/05; für Rechtslenker; + ESP		03.2123-2774.3 010803	ATE Ø 23,8
1.9 SDI	50	11/99→06/06					
1.9 TDI	66	11/99→06/06		→ 07/05; für Linkslenker; - ESP		24.2123-1709.3 010503	Ø 23,8
1.6 16 V	77	09/00→06/06		→ 07/05; für Linkslenker; + ESP		03.2123-2715.3 010802	ATE Ø 23,8
1.8 T Cupra R	165	07/03→06/06		→ 07/05; + ESP; für Rechtslenker		03.2123-2774.3 010803	ATE Ø 23,8
1.9 TDI	96	05/03→06/06					
1.9 TDI Syncro	110	05/02→06/06		→ 07/05; für Linkslenker; - ESP		24.2123-1709.3 010503	Ø 23,8
2.8 Cupra 4	150	02/01→06/06					
1.8 20V T 4	132	11/99→06/06		→ 08/00; für Linkslenker; + ESP		03.2123-2024.3 010597	ATE Ø 23,8
				→ 07/05; für Linkslenker; + ESP		03.2123-2715.3 010802	ATE Ø 23,8
				→ 07/05; + ESP; für Rechtslenker		03.2123-2774.3 010803	ATE Ø 23,8
				→ 07/05; für Linkslenker; - ESP		24.2123-1709.3 010503	Ø 23,8
1.8 T Cupra R	154	02/02→06/06		05/02→ 07/05; für Linkslenker; + ESP		03.2123-2715.3 010802	ATE Ø 23,8
				05/02→ 07/05; + ESP; für Rechtslenker		03.2123-2774.3 010803	ATE Ø 23,8
				05/02→ 07/05; für Linkslenker; - ESP		24.2123-1709.3 010503	Ø 23,8
1.9 TDI	74	10/05→06/06		für Linkslenker; + ESP		03.2123-2715.3 010802	ATE Ø 23,8
2.8	150	05/02→06/04		für Rechtslenker; + ESP		03.2123-2774.3 010803	ATE Ø 23,8
				für Linkslenker; - ESP		24.2123-1709.3 010503	Ø 23,8
1.9 TDI	81	11/99→06/06		→ 08/00; für Linkslenker; + ESP		03.2123-2024.3 010597	ATE Ø 23,8
				→ 07/05; für Linkslenker; + ESP		03.2123-2715.3 010802	ATE Ø 23,8
				09/00→ 07/05; für Rechtslenker; + ESP		03.2123-2774.3 010803	ATE Ø 23,8
				→ 07/05; für Linkslenker; - ESP		24.2123-1709.3 010503	Ø 23,8
1.9 TDI	110	09/00→06/06		02/01→ 07/05; + ESP; für Linkslenker		03.2123-2715.3 010802	ATE Ø 23,8
				02/01→ 07/05; für Rechtslenker; + ESP		03.2123-2774.3 010803	ATE Ø 23,8
				02/01→ 07/05; für Linkslenker; - ESP		24.2123-1709.3 010503	Ø 23,8
SEAT - LEON (1P1) 05/05→12/13							
 Bremskraftverstärker							
1.2 TSI	77	02/10→12/12		→ 05/10; +PR 1AC / 1AT; für Linkslenker; für Kolben-Ø [mm]: 22,2		03.7863-3232.4 300307	ATE Ø 10" pneumatisch
1.4 16V	63	06/06→12/12					
1.4 TSI	92	11/07→12/12					
1.6 LPG	75	12/09→12/12					
→							











	kw			 	! #			
SEAT - LEON (1P1) 05/05→12/13								
Bremskraftverstärker								
1.6 TDI 1.8 TSI 2.0 Cupra R 2.0 TDI 2.0 TFSI	77 118 195 125 155	02/10→12/12 06/07→12/12 09/09→12/12 05/06→12/12 06/09→12/12		06/10→; +PR 1AC / 1AT; → 10/12; für Linkslenker; für Kolben-Ø [mm]: 22,2 → 05/10; +PR 1AC / 1AT; für Linkslenker; für Kolben-Ø [mm]: 23,81		03.7863-3232.4 03.7863-3332.4	300307 300308 300308	ATE Ø 10" pneumatisch ATE Ø 10" pneumatisch ATE Ø 10" pneumatisch
1.6 2.0 TDI 16V	75 103	07/05→12/12 07/05→12/12		06/10→; +PR 1AC / 1AT; → 10/12; für Linkslenker; für Kolben-Ø [mm]: 22,2 08/05→ 05/10; +PR 1AC / 1AT; für Linkslenker; für Kolben-Ø [mm]: 22,2 06/10→; +PR 1AC / 1AT; → 10/12; für Linkslenker; für Kolben-Ø [mm]: 23,81 08/05→ 05/10; +PR 1AC / 1AT; für Linkslenker; für Kolben-Ø [mm]: 23,81		03.7863-3232.4 03.7863-3232.4 03.7863-3332.4 03.7863-3332.4	300307 300307 300308 300308	ATE Ø 10" pneumatisch ATE Ø 10" pneumatisch ATE Ø 10" pneumatisch ATE Ø 10" pneumatisch
1.6 MultiFuel 1.6 TDI	75 66	07/05→08/13 11/10→12/12		für Linkslenker; → 10/12; +PR 1AC / 1AT; für Kolben-Ø [mm]: 22,2 für Linkslenker; → 10/12; +PR 1AC / 1AT; für Kolben-Ø [mm]: 23,81		03.7863-3232.4 03.7863-3332.4	300307 300308	ATE Ø 10" pneumatisch ATE Ø 10" pneumatisch
1.9 TDI 2.0 TDI 2.0 TFSI	66 103 177	06/07→12/10 10/05→10/10 11/06→05/11		→ 05/10; +PR 1AC / 1AT; für Linkslenker; für Kolben-Ø [mm]: 22,2 06/10→; +PR 1AC / 1AT; für Linkslenker; für Kolben-Ø [mm]: 22,2 → 05/10; +PR 1AC / 1AT; für Linkslenker; für Kolben-Ø [mm]: 23,81 06/10→; +PR 1AC / 1AT; für Linkslenker; für Kolben-Ø [mm]: 23,81		03.7863-3232.4 03.7863-3232.4 03.7863-3332.4 03.7863-3332.4	300307 300307 300308 300308	ATE Ø 10" pneumatisch ATE Ø 10" pneumatisch ATE Ø 10" pneumatisch ATE Ø 10" pneumatisch
1.9 TDI	77	07/05→12/10		06/10→; +PR 1AC / 1AT; für Linkslenker; für Kolben-Ø [mm]: 22,2 08/05→ 05/10; +PR 1AC / 1AT; für Linkslenker; für Kolben-Ø [mm]: 22,2 06/10→; +PR 1AC / 1AT; für Linkslenker; für Kolben-Ø [mm]: 23,81 08/05→ 05/10; +PR 1AC / 1AT; für Linkslenker; für Kolben-Ø [mm]: 23,81		03.7863-3232.4 03.7863-3232.4 03.7863-3332.4 03.7863-3332.4	300307 300307 300308 300308	ATE Ø 10" pneumatisch ATE Ø 10" pneumatisch ATE Ø 10" pneumatisch ATE Ø 10" pneumatisch
2.0 FSI 2.0 TDI 2.0 TFSI	110 100 147	07/05→05/10 07/05→05/10 05/05→03/09		08/05→; +PR 1AC / 1AT; für Linkslenker; für Kolben-Ø [mm]: 22,2 08/05→; +PR 1AC / 1AT; für Linkslenker; für Kolben-Ø [mm]: 23,81		03.7863-3232.4 03.7863-3332.4	300307 300308	ATE Ø 10" pneumatisch ATE Ø 10" pneumatisch
2.0 TFSI	136	09/05→05/06		+PR 1AC / 1AT; für Linkslenker; für Kolben-Ø [mm]: 22,2 +PR 1AC / 1AT; für Linkslenker; für Kolben-Ø [mm]: 23,81		03.7863-3232.4 03.7863-3332.4	300307 300308	ATE Ø 10" pneumatisch ATE Ø 10" pneumatisch
Hauptbremszylinder								
1.2 TSI 1.4 16V 1.4 TSI 1.6 LPG 1.6 TDI 1.8 TSI 2.0 Cupra R 2.0 TDI 2.0 TFSI	77 63 92 75 77 118 195 125 155	02/10→12/12 06/06→12/12 11/07→12/12 12/09→12/12 02/10→12/12 06/07→12/12 09/09→12/12 05/06→12/12 06/09→12/12		06/10→; +PR 1ZE / 1ZF; → 10/12; für Linkslenker F1P-6-027023→; → 05/10; für Linkslenker; +PR 1AC / 1AT / 1AS F1P-6-027023→; → 05/10; für Linkslenker; +PR 1AC / 1AT / 1LJ / 1ZA 06/10→; +PR 1LB / 1ZA / 1ZB; → 10/12; für Linkslenker → 05/10; für Rechtslenker		03.2122-2129.3 03.2122-2129.3 03.2123-3449.3 03.2123-3449.3 24.2122-1981.3 24.4152-0132.3 24.4153-0202.3 24.4152-0132.3 24.4152-0132.3 24.4153-0202.3 24.4153-0202.3 03.2122-2129.3 03.2122-2129.3 03.2123-3449.3 03.2123-3449.3	010799 010799 010808 010808 011024 011025 011027 011025 011025 011027 011027 010799 010799 010808 010808	ATE Ø 22,2 ATE Ø 22,2 ATE Ø 23,8 ATE Ø 23,8 ATE Ø 22,2 ohne Bremsflüssigkeitsbehälter ATE Ø 22,2 ohne Bremsflüssigkeitsbehälter ATE Ø 23,8 ohne Bremsflüssigkeitsbehälter ATE Ø 22,2 ohne Bremsflüssigkeitsbehälter ATE Ø 22,2 ohne Bremsflüssigkeitsbehälter ATE Ø 23,8 ohne Bremsflüssigkeitsbehälter ATE Ø 23,8 ohne Bremsflüssigkeitsbehälter ATE Ø 22,2 ATE Ø 22,2 ATE Ø 23,8 ATE Ø 23,8
1.6 2.0 TDI 16V	75 103	07/05→12/12 07/05→12/12		F1P-6-027023→; → 05/10; für Linkslenker; +PR 1AC / 1AT / 1AS 06/10→; +PR 1ZE / 1ZF; → 10/12; für Linkslenker 06/10→; +PR 1LB / 1ZA / 1ZB; → 10/12; für Linkslenker F1P-6-027023→; → 05/10; für Linkslenker; +PR 1AC / 1AT / 1LJ / 1ZA		03.2122-2129.3 03.2122-2129.3 03.2123-3449.3 03.2123-3449.3	010799 010799 010808 010808	ATE Ø 22,2 ATE Ø 22,2 ATE Ø 23,8 ATE Ø 23,8
→								

	kw			 	! #		
SEAT - LEON (1P1) 05/05→12/13							
 Hauptbremszylinder							
1.6 2.0 TDI 16V	75 103	07/05→12/12 07/05→12/12		08/05→ 05/10; für Rechtslenker	24.2122-1981.3	011024	ATE Ø 22,2 ohne Bremsflüssigkeitsbehälter
					24.4152-0132.3	011025	ATE Ø 22,2 ohne Bremsflüssigkeitsbehälter
					24.4153-0202.3	011027	ATE Ø 23,8 ohne Bremsflüssigkeitsbehälter
				06/10→; +PR 1ZE / 1ZF; → 10/12; für Rechtslenker	24.4152-0132.3	011025	ATE Ø 22,2 ohne Bremsflüssigkeitsbehälter
				F1P-6-027023→; → 05/10; für Rechtslenker; +PR 1AC / 1AT / 1AS	24.4152-0132.3	011025	ATE Ø 22,2 ohne Bremsflüssigkeitsbehälter
				06/10→; +PR 1LB / 1ZA / 1ZB; → 10/12; für Rechtslenker	24.4153-0202.3	011027	ATE Ø 23,8 ohne Bremsflüssigkeitsbehälter
1.6 MultiFuel	75	07/05→08/13		für Linkslenker; → 10/12; +PR 1ZE / 1ZF	03.2122-2129.3	010799	ATE Ø 22,2
				für Linkslenker; → 10/12; +PR 1LB / 1ZA / 1ZB	03.2123-3449.3	010808	ATE Ø 23,8
				für Rechtslenker; +PR 1AC / 1AT / 1AS	24.4152-0132.3	011025	ATE Ø 22,2 ohne Bremsflüssigkeitsbehälter
				+PR 1ZE / 1ZF; für Rechtslenker	24.4152-0132.3	011025	ATE Ø 22,2 ohne Bremsflüssigkeitsbehälter
				+PR 1LB / 1ZA / 1ZB; für Rechtslenker	24.4153-0202.3	011027	ATE Ø 23,8 ohne Bremsflüssigkeitsbehälter
				für Rechtslenker; +PR 1AC / 1AT / 1LJ / 1ZA	24.4153-0202.3	011027	ATE Ø 23,8 ohne Bremsflüssigkeitsbehälter
1.6 TDI	66	11/10→12/12		für Linkslenker; → 10/12; +PR 1ZE / 1ZF	03.2122-2129.3	010799	ATE Ø 22,2
				für Linkslenker; → 10/12; +PR 1LB / 1ZA / 1ZB	03.2123-3449.3	010808	ATE Ø 23,8
				für Rechtslenker; → 10/12; +PR 1ZE / 1ZF	24.4152-0132.3	011025	ATE Ø 22,2 ohne Bremsflüssigkeitsbehälter
				für Rechtslenker; → 10/12; +PR 1LB / 1ZA / 1ZB	24.4153-0202.3	011027	ATE Ø 23,8 ohne Bremsflüssigkeitsbehälter
1.9 TDI 2.0 TDI 2.0 TFSI	66 103 177	06/07→12/10 10/05→10/10 11/06→05/11		06/10→; +PR 1ZE / 1ZF; für Linkslenker	03.2122-2129.3	010799	ATE Ø 22,2
				F1P-6-027023→; → 05/10; für Linkslenker; +PR 1AC / 1AT / 1AS	03.2122-2129.3	010799	ATE Ø 22,2
				F1P-6-027023→; → 05/10; für Linkslenker; +PR 1AC / 1AT / 1LJ / 1ZA	03.2123-3449.3	010808	ATE Ø 23,8
				06/10→; +PR 1LB / 1ZA / 1ZB; für Linkslenker	03.2123-3449.3	010808	ATE Ø 23,8
				→ 05/10; für Rechtslenker	24.2122-1981.3	011024	ATE Ø 22,2 ohne Bremsflüssigkeitsbehälter
					24.4152-0132.3	011025	ATE Ø 22,2 ohne Bremsflüssigkeitsbehälter
					24.4153-0202.3	011027	ATE Ø 23,8 ohne Bremsflüssigkeitsbehälter
				06/10→; +PR 1ZE / 1ZF; für Rechtslenker	24.4152-0132.3	011025	ATE Ø 22,2 ohne Bremsflüssigkeitsbehälter
				F1P-6-027023→; → 05/10; für Rechtslenker; +PR 1AC / 1AT / 1AS	24.4152-0132.3	011025	ATE Ø 22,2 ohne Bremsflüssigkeitsbehälter
				F1P-6-027023→; → 05/10; für Rechtslenker; +PR 1AC / 1AT / 1LJ / 1ZA	24.4153-0202.3	011027	ATE Ø 23,8 ohne Bremsflüssigkeitsbehälter
1.9 TDI	77	07/05→12/10		F1P-6-027023→; → 05/10; für Linkslenker; +PR 1AC / 1AT / 1AS	03.2122-2129.3	010799	ATE Ø 22,2
				06/10→; +PR 1ZE / 1ZF; für Linkslenker	03.2122-2129.3	010799	ATE Ø 22,2
				06/10→; +PR 1LB / 1ZA / 1ZB; für Linkslenker	03.2123-3449.3	010808	ATE Ø 23,8
				F1P-6-027023→; → 05/10; für Linkslenker; +PR 1AC / 1AT / 1LJ / 1ZA	03.2123-3449.3	010808	ATE Ø 23,8
				08/05→ 05/10; für Rechtslenker	24.2122-1981.3	011024	ATE Ø 22,2 ohne Bremsflüssigkeitsbehälter
					24.4152-0132.3	011025	ATE Ø 22,2 ohne Bremsflüssigkeitsbehälter
					24.4153-0202.3	011027	ATE Ø 23,8 ohne Bremsflüssigkeitsbehälter
	06/10→; +PR 1ZE / 1ZF; für Rechtslenker	24.4152-0132.3	011025	ATE Ø 22,2 ohne Bremsflüssigkeitsbehälter			
	F1P-6-027023→; → 05/10; für Rechtslenker; +PR 1AC / 1AT / 1AS	24.4152-0132.3	011025	ATE Ø 22,2 ohne Bremsflüssigkeitsbehälter			

→



	kw			 	! #		
SEAT - LEON (1P1) 05/05→12/13							
 Hauptbremszylinder							
1.9 TDI	77	07/05→12/10		06/10→; +PR 1LB / 1ZA / 1ZB; für Rechtslenker	24.4153-0202.3	011027	ATE Ø 23,8 ohne Bremsflüssigkeitsbehälter
				F1P-6-027023→; → 05/10; für Rechtslenker; +PR 1AC / 1AT / 1LJ / 1ZA	24.4153-0202.3	011027	ATE Ø 23,8 ohne Bremsflüssigkeitsbehälter
2.0 FSI 2.0 TDI 2.0 TFSI	110	07/05→05/10		F1P-6-027023→; für Linkslenker; +PR 1AC / 1AT / 1AS	03.2122-2129.3	010799	ATE Ø 22,2
	100	07/05→05/10		F1P-6-027023→; für Linkslenker; +PR 1AC / 1AT / 1LJ / 1ZA	03.2123-3449.3	010808	ATE Ø 23,8
	147	05/05→03/09		08/05→; für Rechtslenker	24.2122-1981.3	011024	ATE Ø 22,2 ohne Bremsflüssigkeitsbehälter
				F1P-6-027023→; für Rechtslenker; +PR 1AC / 1AT / 1AS	24.4152-0132.3	011025	ATE Ø 22,2 ohne Bremsflüssigkeitsbehälter
				+PR 1ZE / 1ZF; für Rechtslenker	24.4152-0132.3	011025	ATE Ø 22,2 ohne Bremsflüssigkeitsbehälter
				+PR 1LB / 1ZA / 1ZB; für Rechtslenker	24.4153-0202.3	011027	ATE Ø 23,8 ohne Bremsflüssigkeitsbehälter
				F1P-6-027023→; für Rechtslenker; +PR 1AC / 1AT / 1LJ / 1ZA	24.4153-0202.3	011027	ATE Ø 23,8 ohne Bremsflüssigkeitsbehälter
2.0 TFSI	136	09/05→05/06		F1P-6-027023→; für Linkslenker; +PR 1AC / 1AT / 1AS	03.2122-2129.3	010799	ATE Ø 22,2
				F1P-6-027023→; für Linkslenker; +PR 1AC / 1AT / 1LJ / 1ZA	03.2123-3449.3	010808	ATE Ø 23,8
				für Rechtslenker	24.2122-1981.3	011024	ATE Ø 22,2 ohne Bremsflüssigkeitsbehälter
				F1P-6-027023→; für Rechtslenker; +PR 1AC / 1AT / 1AS	24.4152-0132.3	011025	ATE Ø 22,2 ohne Bremsflüssigkeitsbehälter
				+PR 1ZE / 1ZF; für Rechtslenker	24.4152-0132.3	011025	ATE Ø 22,2 ohne Bremsflüssigkeitsbehälter
				+PR 1LB / 1ZA / 1ZB; für Rechtslenker	24.4153-0202.3	011027	ATE Ø 23,8 ohne Bremsflüssigkeitsbehälter
Drucksensor, Bremskraftverstärker							
1.2 TSI	77	02/10→12/12		→ 10/12; +PR 1AS	03.0655-0101.2	370008	ATE
1.4 16V	63	06/06→12/12					
1.4 TSI	92	11/07→12/12					
1.6 LPG	75	12/09→12/12					
1.6 MultiFuel	75	07/05→08/13					
1.6 TDI	66 -	02/10→12/12					
	77						
1.8 TSI	118	06/07→12/12					
2.0 Cupra R	195	09/09→12/12					
2.0 TDI	125	05/06→12/12					
2.0 TFSI	155	06/09→12/12					
1.6	75	07/05→12/12		08/05→; +PR 1AS; → 10/12	03.0655-0101.2	370008	ATE
2.0 TDI 16V	103	07/05→12/12					
1.9 TDI	66	06/07→12/10		+PR 1AS	03.0655-0101.2	370008	ATE
2.0 TDI	103	10/05→10/10					
2.0 TFSI	136 -	09/05→05/11					
	177						
1.9 TDI	77	07/05→12/10		08/05→; +PR 1AS	03.0655-0101.2	370008	ATE
2.0 FSI	110	07/05→05/10					
2.0 TDI	100	07/05→05/10					
2.0 TFSI	147	05/05→03/09					
SEAT - LEON (5F1) 09/12→05/21							
 Hauptbremszylinder							
1.0 TSi	63	09/18→08/20		für Linkslenker	03.4153-5403.3	010994	ATE Ø 23,8
1.5 TGi	96	10/18→08/20			24.4123-1719.3	011017	TRW Ø 23,8 ohne Bremsflüssigkeitsbehälter
	96 -	09/18→08/20					
1.5 TSI	110	09/18→08/20			24.4153-1522.3	011048	ATE Ø 23,8 ohne Bremsflüssigkeitsbehälter
	140						
2.0 TSI	140	09/18→08/20		für Linkslenker; +PR 1ZA / 1ZE	24.4123-1719.3	011017	TRW Ø 23,8 ohne Bremsflüssigkeitsbehälter
					24.4153-1522.3	011048	ATE Ø 23,8 ohne Bremsflüssigkeitsbehälter
1.0 TSI	85	05/15→08/20		für Linkslenker	03.4153-5403.3	010994	ATE Ø 23,8
1.2 TSI	81	04/14→08/20			24.4123-1719.3	011017	TRW Ø 23,8 ohne Bremsflüssigkeitsbehälter
1.4 TSI	92 -	05/14→08/20					
2.0 Cupra	110	10/15→08/20			24.4153-1522.3	011048	ATE Ø 23,8 ohne Bremsflüssigkeitsbehälter
	213						
→							

SEAT - LEON (5F1) 09/12→05/21









Hauptbremszylinder









1.0 TSI	85	05/15→08/20		11/16→; für Linkslenker; +PR 1ZA / 1ZE	24.4123-1719.3	011017	TRW Ø 23,8 ohne Bremsflüssigkeitsbehälter
1.2 TSI	81	04/14→08/20					
1.4 TSI	92 - 110	05/14→08/20		für Linkslenker; +PR 1ZA / 1ZE	24.4153-1522.3	011048	ATE Ø 23,8 ohne Bremsflüssigkeitsbehälter
2.0 Cupra	213	10/15→08/20					
1.2 TSI	63 - 77	12/12→08/20		für Linkslenker	03.4153-5403.3	010994	ATE Ø 23,8
1.4 TSI	103	09/12→08/20			24.4123-1719.3	011017	TRW Ø 23,8 ohne Bremsflüssigkeitsbehälter
1.6 TDI	66 - 81	09/12→08/20		11/16→; für Linkslenker; +PR 1ZA / 1ZE	24.4123-1719.3	011017	TRW Ø 23,8 ohne Bremsflüssigkeitsbehälter
1.8 TSI	132	02/13→08/18					
2.0 Cupra	195 - 206	10/13→08/20		02/14→; für Linkslenker	24.4153-1522.3	011048	ATE Ø 23,8 ohne Bremsflüssigkeitsbehälter
2.0 TDI	81 - 135	09/12→08/20		02/14→; für Linkslenker; +PR 1ZA / 1ZE	24.4153-1522.3	011048	ATE Ø 23,8 ohne Bremsflüssigkeitsbehälter
1.4 TGI	81	02/13→08/18		10/13→; für Linkslenker	03.4153-5403.3	010994	ATE Ø 23,8
				11/16→; für Linkslenker; +PR 1ZA / 1ZE	24.4123-1719.3	011017	TRW Ø 23,8 ohne Bremsflüssigkeitsbehälter
				02/14→; für Linkslenker	24.4153-1522.3	011048	ATE Ø 23,8 ohne Bremsflüssigkeitsbehälter
				02/14→; für Linkslenker; +PR 1ZA / 1ZE	24.4153-1522.3	011048	ATE Ø 23,8 ohne Bremsflüssigkeitsbehälter
1.4 TSI	90	11/12→10/16		für Linkslenker	03.4153-5403.3	010994	ATE Ø 23,8
				für Linkslenker; +PR 1ZA / 1ZE	24.4123-1719.3	011017	TRW Ø 23,8 ohne Bremsflüssigkeitsbehälter
				02/14→; für Linkslenker	24.4153-1522.3	011048	ATE Ø 23,8 ohne Bremsflüssigkeitsbehälter
				02/14→; für Linkslenker; +PR 1ZA / 1ZE	24.4153-1522.3	011048	ATE Ø 23,8 ohne Bremsflüssigkeitsbehälter
1.6 TDI	85	11/16→08/20		01/17→; für Linkslenker	03.4153-5403.3	010994	ATE Ø 23,8
				01/17→; für Linkslenker; +PR 1ZA / 1ZE	24.4123-1719.3	011017	TRW Ø 23,8 ohne Bremsflüssigkeitsbehälter
				für Linkslenker; +PR 1ZA / 1ZE	24.4153-1522.3	011048	ATE Ø 23,8 ohne Bremsflüssigkeitsbehälter
				für Linkslenker	24.4153-1522.3	011048	ATE Ø 23,8 ohne Bremsflüssigkeitsbehälter
2.0 Cupra	221	01/17→08/18		für Linkslenker; +PR 1ZA / 1ZE	24.4123-1719.3	011017	TRW Ø 23,8 ohne Bremsflüssigkeitsbehälter
2.0 Cupra R	228	11/17→08/18			24.4153-1522.3	011048	ATE Ø 23,8 ohne Bremsflüssigkeitsbehälter

SEAT - LEON Kasten/Schrägheck (5F1) 09/12→08/20











Hauptbremszylinder











1.0 TSI	85	05/15→08/20		für Linkslenker	03.4153-5403.3	010994	ATE Ø 23,8
1.2 TSI	81	04/14→08/18			24.4123-1719.3	011017	TRW Ø 23,8 ohne Bremsflüssigkeitsbehälter
1.4 TSI	110	05/14→08/20			24.4153-1522.3	011048	ATE Ø 23,8 ohne Bremsflüssigkeitsbehälter
				11/16→; für Linkslenker; +PR 1ZA / 1ZE	24.4123-1719.3	011017	TRW Ø 23,8 ohne Bremsflüssigkeitsbehälter
				für Linkslenker; +PR 1ZA / 1ZE	24.4153-1522.3	011048	ATE Ø 23,8 ohne Bremsflüssigkeitsbehälter
1.2 TSI	63	01/13→08/18		für Linkslenker	03.4153-5403.3	010994	ATE Ø 23,8
1.8 TFSI	132	02/13→08/18			24.4123-1719.3	011017	TRW Ø 23,8 ohne Bremsflüssigkeitsbehälter
2.0 TDI	110 - 135	10/12→08/18		11/16→; für Linkslenker; +PR 1ZA / 1ZE	24.4123-1719.3	011017	TRW Ø 23,8 ohne Bremsflüssigkeitsbehälter
				02/14→; für Linkslenker	24.4153-1522.3	011048	ATE Ø 23,8 ohne Bremsflüssigkeitsbehälter
				02/14→; für Linkslenker; +PR 1ZA / 1ZE	24.4153-1522.3	011048	ATE Ø 23,8 ohne Bremsflüssigkeitsbehälter
1.4 TSI	90 - 103	09/12→10/16		für Linkslenker	03.4153-5403.3	010994	ATE Ø 23,8
1.6 TDI	66 - 81	09/12→10/16		für Linkslenker; +PR 1ZA / 1ZE	24.4123-1719.3	011017	TRW Ø 23,8 ohne Bremsflüssigkeitsbehälter
→							













	kw					! #		
SEAT - LEON Kasten/Schrägheck (5F1) 09/12→08/20								
 Hauptbremszylinder								
1.4 TSI	90 - 103	09/12→10/16		02/14→; für Linkslenker		24.4153-1522.3	011048	ATE Ø 23,8 ohne Bremsflüssigkeitsbehälter
1.6 TDI	66 - 81	09/12→10/16		02/14→; für Linkslenker; +PR 1ZA / 1ZE		24.4153-1522.3	011048	ATE Ø 23,8 ohne Bremsflüssigkeitsbehälter
1.6 TDI	85	11/16→08/20		01/17→; für Linkslenker		03.4153-5403.3	010994	ATE Ø 23,8
						24.4123-1719.3	011017	TRW Ø 23,8 ohne Bremsflüssigkeitsbehälter
				01/17→; für Linkslenker; +PR 1ZA / 1ZE		24.4123-1719.3	011017	TRW Ø 23,8 ohne Bremsflüssigkeitsbehälter
				für Linkslenker; +PR 1ZA / 1ZE		24.4153-1522.3	011048	ATE Ø 23,8 ohne Bremsflüssigkeitsbehälter
			für Linkslenker		24.4153-1522.3	011048	ATE Ø 23,8 ohne Bremsflüssigkeitsbehälter	
2.0 Cupra	213	09/15→10/16		für Linkslenker		03.4153-5403.3	010994	ATE Ø 23,8
						24.4153-1522.3	011048	ATE Ø 23,8 ohne Bremsflüssigkeitsbehälter
				für Linkslenker; +PR 1ZA / 1ZE		24.4123-1719.3	011017	TRW Ø 23,8 ohne Bremsflüssigkeitsbehälter
					24.4153-1522.3	011048	ATE Ø 23,8 ohne Bremsflüssigkeitsbehälter	
2.0 Cupra	221	01/17→08/18		für Linkslenker		03.4153-5403.3	010994	ATE Ø 23,8
						24.4123-1719.3	011017	TRW Ø 23,8 ohne Bremsflüssigkeitsbehälter
						24.4153-1522.3	011048	ATE Ø 23,8 ohne Bremsflüssigkeitsbehälter
				für Linkslenker; +PR 1ZA / 1ZE		24.4123-1719.3	011017	TRW Ø 23,8 ohne Bremsflüssigkeitsbehälter
					24.4153-1522.3	011048	ATE Ø 23,8 ohne Bremsflüssigkeitsbehälter	
SEAT - LEON SC (5F5) 01/13→12/18								
 Hauptbremszylinder								
1.0 TSI	85	05/15→08/18		für Linkslenker		03.4153-5403.3	010994	ATE Ø 23,8
1.2 TSI	81	05/14→08/18				24.4123-1719.3	011017	TRW Ø 23,8 ohne Bremsflüssigkeitsbehälter
1.4 TSI	92 - 110	05/14→08/18				24.4153-1522.3	011048	ATE Ø 23,8 ohne Bremsflüssigkeitsbehälter
2.0 Cupra	213	10/15→11/16				24.4153-1522.3	011048	ATE Ø 23,8 ohne Bremsflüssigkeitsbehälter
				11/16→; für Linkslenker; +PR 1ZA / 1ZE		24.4123-1719.3	011017	TRW Ø 23,8 ohne Bremsflüssigkeitsbehälter
				für Linkslenker; +PR 1ZA / 1ZE		24.4153-1522.3	011048	ATE Ø 23,8 ohne Bremsflüssigkeitsbehälter
1.2 TSI	63	01/13→08/18		für Linkslenker		03.4153-5403.3	010994	ATE Ø 23,8
1.4 TSI	103	02/13→11/16				24.4123-1719.3	011017	TRW Ø 23,8 ohne Bremsflüssigkeitsbehälter
1.6 TDI	66 - 81	02/13→08/18				24.4153-1522.3	011048	ATE Ø 23,8 ohne Bremsflüssigkeitsbehälter
1.8 TSI	132	02/13→08/18		11/16→; für Linkslenker; +PR 1ZA / 1ZE		24.4123-1719.3	011017	TRW Ø 23,8 ohne Bremsflüssigkeitsbehälter
2.0 Cupra	195 - 206	10/13→11/16				24.4153-1522.3	011048	ATE Ø 23,8 ohne Bremsflüssigkeitsbehälter
2.0 TDI	81 - 135	02/13→08/18		02/14→; für Linkslenker		24.4153-1522.3	011048	ATE Ø 23,8 ohne Bremsflüssigkeitsbehälter
				02/14→; für Linkslenker; +PR 1ZA / 1ZE		24.4153-1522.3	011048	ATE Ø 23,8 ohne Bremsflüssigkeitsbehälter
1.2 TSI	77	02/13→04/14		für Linkslenker		03.4153-5403.3	010994	ATE Ø 23,8
1.4 TSI	90	02/13→06/15				24.4123-1719.3	011017	TRW Ø 23,8 ohne Bremsflüssigkeitsbehälter
				02/14→; für Linkslenker		24.4153-1522.3	011048	ATE Ø 23,8 ohne Bremsflüssigkeitsbehälter
				02/14→; für Linkslenker; +PR 1ZA / 1ZE		24.4153-1522.3	011048	ATE Ø 23,8 ohne Bremsflüssigkeitsbehälter
1.6 TDI	85	11/16→08/18		01/17→; für Linkslenker		03.4153-5403.3	010994	ATE Ø 23,8
						24.4123-1719.3	011017	TRW Ø 23,8 ohne Bremsflüssigkeitsbehälter
				01/17→; für Linkslenker; +PR 1ZA / 1ZE		24.4123-1719.3	011017	TRW Ø 23,8 ohne Bremsflüssigkeitsbehälter
				für Linkslenker; +PR 1ZA / 1ZE		24.4153-1522.3	011048	ATE Ø 23,8 ohne Bremsflüssigkeitsbehälter
				für Linkslenker		24.4153-1522.3	011048	ATE Ø 23,8 ohne Bremsflüssigkeitsbehälter
2.0 Cupra	221	01/17→08/18		für Linkslenker; +PR 1ZA / 1ZE		24.4123-1719.3	011017	TRW Ø 23,8 ohne Bremsflüssigkeitsbehälter
						24.4153-1522.3	011048	ATE Ø 23,8 ohne Bremsflüssigkeitsbehälter













	kw			 	! #		
SEAT - LEON ST (5F8) 09/12→08/20							
 Hauptbremszylinder							
1.0 TSi 1.5 TGi 1.5 TSi 2.0 Cupra 2.0 Cupra 4Drive	63 96 96 - 110 213 - 221 221	09/18→08/20 10/18→08/20 09/18→08/20 10/15→08/20 11/16→08/20		für Linkslenker für Linkslenker; +PR 1ZA / 1ZE		03.4153-5403.3 010994 24.4123-1719.3 011017 24.4153-1522.3 011048 24.4123-1719.3 011017 24.4153-1522.3 011048	ATE Ø 23,8 TRW Ø 23,8 ohne Bremsflüssigkeitsbehälter ATE Ø 23,8 ohne Bremsflüssigkeitsbehälter TRW Ø 23,8 ohne Bremsflüssigkeitsbehälter ATE Ø 23,8 ohne Bremsflüssigkeitsbehälter
1.0 TSi 1.2 TSi 1.4 TSi 1.6 TDI 4Drive 1.8 TSi 4Drive 2.0 TDI 4Drive	85 81 92 - 110 77 - 81 132 110 - 135	05/15→08/20 05/14→08/20 05/14→08/20 04/14→08/20 11/14→08/18 04/14→08/20		für Linkslenker 11/16→; für Linkslenker; +PR 1ZA / 1ZE für Linkslenker; +PR 1ZA / 1ZE		03.4153-5403.3 010994 24.4123-1719.3 011017 24.4153-1522.3 011048 24.4123-1719.3 011017 24.4153-1522.3 011048	ATE Ø 23,8 TRW Ø 23,8 ohne Bremsflüssigkeitsbehälter ATE Ø 23,8 ohne Bremsflüssigkeitsbehälter TRW Ø 23,8 ohne Bremsflüssigkeitsbehälter ATE Ø 23,8 ohne Bremsflüssigkeitsbehälter
1.2 TSi 1.4 TGi 1.4 TSi 1.6 TDI 1.8 TSi 2.0 Cupra 2.0 TDI	63 - 77 81 103 66 - 81 132 195 - 206 81 - 135	08/13→08/20 10/13→08/18 10/13→08/20 09/13→08/20 10/13→08/18 10/13→08/20 02/13→08/20		für Linkslenker 11/16→; für Linkslenker; +PR 1ZA / 1ZE 02/14→; für Linkslenker 02/14→; für Linkslenker; +PR 1ZA / 1ZE		03.4153-5403.3 010994 24.4123-1719.3 011017 24.4123-1719.3 011017 24.4153-1522.3 011048 24.4153-1522.3 011048	ATE Ø 23,8 TRW Ø 23,8 ohne Bremsflüssigkeitsbehälter TRW Ø 23,8 ohne Bremsflüssigkeitsbehälter ATE Ø 23,8 ohne Bremsflüssigkeitsbehälter ATE Ø 23,8 ohne Bremsflüssigkeitsbehälter
1.4 TSi	90	09/12→06/15		für Linkslenker für Linkslenker; +PR 1ZA / 1ZE 02/14→; für Linkslenker 02/14→; für Linkslenker; +PR 1ZA / 1ZE		03.4153-5403.3 010994 24.4123-1719.3 011017 24.4153-1522.3 011048 24.4153-1522.3 011048	ATE Ø 23,8 TRW Ø 23,8 ohne Bremsflüssigkeitsbehälter ATE Ø 23,8 ohne Bremsflüssigkeitsbehälter ATE Ø 23,8 ohne Bremsflüssigkeitsbehälter
1.6 TDI	85	11/16→08/20		01/17→; für Linkslenker 01/17→; für Linkslenker; +PR 1ZA / 1ZE für Linkslenker; +PR 1ZA / 1ZE für Linkslenker		03.4153-5403.3 010994 24.4123-1719.3 011017 24.4153-1522.3 011048 24.4153-1522.3 011048	ATE Ø 23,8 TRW Ø 23,8 ohne Bremsflüssigkeitsbehälter ATE Ø 23,8 ohne Bremsflüssigkeitsbehälter ATE Ø 23,8 ohne Bremsflüssigkeitsbehälter
1.6 TDI 4Drive 2.0 TSi 2.0 TSi 4Drive	85 140 140	07/18→08/20 07/18→08/20 09/18→08/20		für Linkslenker für Linkslenker; +PR 1ZA / 1ZE		03.4153-5403.3 010994 24.4123-1719.3 011017 24.4153-1522.3 011048	ATE Ø 23,8 TRW Ø 23,8 ohne Bremsflüssigkeitsbehälter ATE Ø 23,8 ohne Bremsflüssigkeitsbehälter
SEAT - LEON ST Kasten/Kombi (5F8) 01/13→08/20							
 Hauptbremszylinder							
1.0 TSi 1.2 TSi 1.4 TSi 2.0 TDI 4Drive	85 81 110 110 - 135	05/15→08/20 05/14→08/18 05/14→08/20 09/14→08/18		für Linkslenker 11/16→; für Linkslenker; +PR 1ZA / 1ZE für Linkslenker; +PR 1ZA / 1ZE		03.4153-5403.3 010994 24.4123-1719.3 011017 24.4153-1522.3 011048 24.4123-1719.3 011017 24.4153-1522.3 011048	ATE Ø 23,8 TRW Ø 23,8 ohne Bremsflüssigkeitsbehälter ATE Ø 23,8 ohne Bremsflüssigkeitsbehälter TRW Ø 23,8 ohne Bremsflüssigkeitsbehälter ATE Ø 23,8 ohne Bremsflüssigkeitsbehälter
1.2 TSi 1.6 TDI 1.8 TFSI 2.0 Cupra 2.0 TDI	63 81 132 206 110 - 135	01/13→08/18 09/13→08/20 10/13→08/18 10/13→08/20 04/13→08/18		für Linkslenker 11/16→; für Linkslenker; +PR 1ZA / 1ZE		03.4153-5403.3 010994 24.4123-1719.3 011017 24.4123-1719.3 011017	ATE Ø 23,8 TRW Ø 23,8 ohne Bremsflüssigkeitsbehälter TRW Ø 23,8 ohne Bremsflüssigkeitsbehälter
→							























	kw					! #		
SEAT - LEON ST Kasten/Kombi (5F8) 01/13→08/20								
 Hauptbremszylinder								
1.2 TSI 1.6 TDI 1.8 TFSI 2.0 Cupra 2.0 TDI	63 81 132 206 110 - 135	01/13→08/18 09/13→08/20 10/13→08/18 10/13→08/20 04/13→08/18		02/14→; für Linkslenker			24.4153-1522.3 011048	ATE Ø 23,8 ohne Bremsflüssigkeitsbehälter
				02/14→; für Linkslenker; +PR 1ZA / 1ZE			24.4153-1522.3 011048	ATE Ø 23,8 ohne Bremsflüssigkeitsbehälter
1.6 TDI	85	11/16→08/20		01/17→; für Linkslenker			03.4153-5403.3 010994 24.4123-1719.3 011017	ATE Ø 23,8 TRW Ø 23,8 ohne Bremsflüssigkeitsbehälter
				01/17→; für Linkslenker; +PR 1ZA / 1ZE			24.4123-1719.3 011017	TRW Ø 23,8 ohne Bremsflüssigkeitsbehälter
				für Linkslenker; +PR 1ZA / 1ZE			24.4153-1522.3 011048	ATE Ø 23,8 ohne Bremsflüssigkeitsbehälter
				für Linkslenker			24.4153-1522.3 011048	ATE Ø 23,8 ohne Bremsflüssigkeitsbehälter
2.0 Cupra	221	11/16→08/18		für Linkslenker; +PR 1ZA / 1ZE			24.4123-1719.3 011017 24.4153-1522.3 011048	TRW Ø 23,8 ohne Bremsflüssigkeitsbehälter ATE Ø 23,8 ohne Bremsflüssigkeitsbehälter
2.0 Cupra 4Drive	221	11/16→08/18		für Linkslenker			03.4153-5403.3 010994 24.4123-1719.3 011017 24.4153-1522.3 011048	ATE Ø 23,8 TRW Ø 23,8 ohne Bremsflüssigkeitsbehälter ATE Ø 23,8 ohne Bremsflüssigkeitsbehälter
				für Linkslenker; +PR 1ZA / 1ZE			24.4123-1719.3 011017 24.4153-1522.3 011048	TRW Ø 23,8 ohne Bremsflüssigkeitsbehälter ATE Ø 23,8 ohne Bremsflüssigkeitsbehälter
SEAT - MARBELLA Kasten/Schrägheck (028A) 11/86→05/99								
 Hauptbremszylinder								
0.9	30	05/95→05/99					24.2119-0826.3 010349	Ø 19
SEAT - Mii (KF1, KE1) 10/11→								
 Hauptbremszylinder								
1.0	44 - 55	10/11→07/19		05/12→			24.4120-1703.3 011015	TRW Ø 20,6 ohne Bremsflüssigkeitsbehälter
1.0 EcoFuel	50	10/12→07/19					24.4120-1703.3 011015	TRW Ø 20,6 ohne Bremsflüssigkeitsbehälter
SEAT - TOLEDO I (1L2) 01/91→10/99								
 Hauptbremszylinder								
1.6 i	54	05/91→03/99		09/91→; → 1L-ZD101450			03.2120-2031.3 010106	ATE Ø 20,6
				1L-ZD101451→ 1L-ZD315000			03.2120-3943.3 010532	ATE Ø 20,6
				→ 09/98; 1L-ZD315001→			03.2122-1042.3 010137	Ø 22,2
1.6 i	55 - 74	01/93→03/99		→ 1L-ZD101450			03.2120-2031.3 010106	ATE Ø 20,6
				1L-ZD101451→ 1L-ZD315000			03.2120-3943.3 010532	ATE Ø 20,6
				→ 09/98; 1L-ZD315001→			03.2122-1042.3 010137	Ø 22,2
1.8 16V	92 - 98	05/91→03/99		09/91→ 03/94; für Linkslenker			10.6123-0674.3 010639	ATE Ø 23,8
1.9 D	47	12/95→03/99		→ 1L-ZD315000			03.2120-3943.3 010532	ATE Ø 20,6
				→ 09/98; 1L-ZD315001→			03.2122-1042.3 010137	Ø 22,2
1.9 D	50	05/91→03/99		09/91→; → 1L-ZD315000			03.2120-3943.3 010532	ATE Ø 20,6
				→ 09/98; 1L-ZD315001→			03.2122-1042.3 010137	Ø 22,2
1.9 TD	55	05/91→03/99		09/91→; → 1L-ZD315000; - ABS			03.2120-3943.3 010532	ATE Ø 20,6
				→ 09/98; 1L-ZD315001→; - ABS			03.2122-1042.3 010137	Ø 22,2
1.9 TDI	66 - 81	08/95→03/99		→ 09/98; - ABS			03.2122-1042.3 010137	Ø 22,2
				→ 09/98; für Linkslenker; + ABS			10.6123-0674.3 010639	ATE Ø 23,8
2.0 i	85	05/91→03/99		09/91→ 09/98; für Linkslenker			10.6123-0674.3 010639	ATE Ø 23,8
2.0 i 16V	110	11/93→03/99		03/94→ 09/98; für Linkslenker			10.6123-0674.3 010639	ATE Ø 23,8
Verschlusschraube, Hauptbremszylinder								
1.6 i	54	05/91→03/99		→ 09/98; 1L-ZD315001→			03.3517-0101.2 390322	
				09/91→; → 1L-ZD101450			03.3517-0101.2 390322	
				1L-ZD101451→ 1L-ZD315000			03.3517-0101.2 390322	
1.6 i	55 - 74	01/93→03/99		→ 1L-ZD101450			03.3517-0101.2 390322	
→								













	kw			 	! #		
SEAT - TOLEDO I (1L2) 01/91→10/99							
Verschlussschraube, Hauptbremszylinder							
1.6 i	55 - 74	01/93→03/99		→ 09/98; 1L-ZD315001→ 1L-ZD101451→ 1L-ZD315000		03.3517-0101.2 390322	
1.9 D	47	12/95→03/99		→ 1L-ZD315000 → 09/98; 1L-ZD315001→		03.3517-0101.2 390322	
1.9 D	50	05/91→03/99		→ 09/98; 1L-ZD315001→ 09/91→; → 1L-ZD315000		03.3517-0101.2 390322	
1.9 TD	55	05/91→03/99		→ 09/98; 1L-ZD315001→; - ABS 09/91→; → 1L-ZD315000; - ABS		03.3517-0101.2 390322	
1.9 TDI	66 - 81	08/95→03/99		→ 09/98; - ABS		03.3517-0101.2 390322	
SEAT - TOLEDO II (1M2) 10/98→05/06							
 Bremskraftverstärker							
1.4 16V 1.6 1.8 20V 1.9 TDI	55 74 92 66 - 110	01/00→05/02 10/98→07/04 10/98→07/04 10/98→05/06		1M-1R023639→; für Linkslenker; + ESP 1M-1B018342→; für Linkslenker; + ESP → 1M-1R023638; + ESP; für Linkslenker → 1M-1B018341; + ESP; für Linkslenker		03.7860-0602.4 300141 03.7860-0602.4 300141 03.7863-0402.4 300124 03.7863-0402.4 300124	ATE Ø 10" pneumatisch ATE Ø 10" pneumatisch ATE Ø 10" pneumatisch ATE Ø 10" pneumatisch
2.3 V5 2.3 V5 20V	110 125	10/98→11/00 09/00→11/03					
1.6 16V 1.9 TDI	77 96	06/00→05/06 05/03→05/06		1M-1R023639→; → 09/04; für Linkslenker; + ESP 1M-1B018342→; → 09/04; für Linkslenker; + ESP → 1M-1R023638; + ESP; für Linkslenker → 1M-1B018341; + ESP; für Linkslenker		03.7860-0602.4 300141 03.7860-0602.4 300141 03.7863-0402.4 300124 03.7863-0402.4 300124	ATE Ø 10" pneumatisch ATE Ø 10" pneumatisch ATE Ø 10" pneumatisch ATE Ø 10" pneumatisch
1.8 20VT	132	09/00→07/04		1M-1B018342→; für Linkslenker; + ESP 1M-1R023639→; für Linkslenker; + ESP 05/01→; → 1M-1B018341; für Linkslenker; + ESP 05/01→; → 1M-1R023638; für Linkslenker; + ESP		03.7860-0602.4 300141 03.7860-0602.4 300141 03.7863-0402.4 300124 03.7863-0402.4 300124	ATE Ø 10" pneumatisch ATE Ø 10" pneumatisch ATE Ø 10" pneumatisch ATE Ø 10" pneumatisch
 Hauptbremszylinder							
1.4 16V 1.6 1.8 20V 1.9 TDI	55 74 92 66 - 81	01/00→05/02 10/98→07/04 10/98→07/04 10/98→07/04		→ 08/00; für Linkslenker; + ESP 09/00→; für Linkslenker; + ESP 09/00→; + ESP; für Rechtslenker für Linkslenker; - ESP		03.2123-2024.3 010597 03.2123-2715.3 010802 03.2123-2774.3 010803 24.2123-1709.3 010503	ATE Ø 23,8 ATE Ø 23,8 ATE Ø 23,8 Ø 23,8
2.3 V5	110	10/98→11/00					
1.6 16V	77	06/00→05/06		→ 08/00; für Linkslenker; + ESP 09/00→ 09/04; für Linkslenker; + ESP 09/00→ 09/04; für Rechtslenker; + ESP → 09/04; - ESP; für Linkslenker		03.2123-2024.3 010597 03.2123-2715.3 010802 03.2123-2774.3 010803 24.2123-1709.3 010503	ATE Ø 23,8 ATE Ø 23,8 ATE Ø 23,8 Ø 23,8
1.8 20VT	132	09/00→07/04		05/01→; + ESP; für Linkslenker 05/01→; für Rechtslenker; + ESP		03.2123-2715.3 010802 03.2123-2774.3 010803	ATE Ø 23,8 ATE Ø 23,8
1.9 TDI 2.3 V5 20V	74 - 110 125	10/00→05/06 09/00→11/03		für Linkslenker; + ESP + ESP; für Rechtslenker für Linkslenker; - ESP		03.2123-2715.3 010802 03.2123-2774.3 010803 24.2123-1709.3 010503	ATE Ø 23,8 ATE Ø 23,8 Ø 23,8
1.9 TDI	96	05/03→05/06		→ 09/04; für Linkslenker; + ESP → 09/04; + ESP; für Rechtslenker → 09/04; - ESP; für Linkslenker		03.2123-2715.3 010802 03.2123-2774.3 010803 24.2123-1709.3 010503	ATE Ø 23,8 ATE Ø 23,8 Ø 23,8
SEAT - TOLEDO III (5P2) 04/04→05/09							
 Bremskraftverstärker							
1.4 16V 1.4 TSI 1.6 1.8 TFSI 1.9 TDI 2.0 FSI 2.0 TDI 2.0 TFSI	63 92 75 118 77 110 103 - 125 147	05/06→05/09 11/07→05/09 10/04→05/09 01/07→05/09 10/04→05/09 10/04→05/09 11/05→05/09 11/05→05/09		→ 03/09; für Linkslenker; +PR 1AC / 1AT		03.7863-3232.4 300307	ATE Ø 10" pneumatisch
2.0 TDI 2.0 TDI 16V	100 103	09/04→05/09 04/04→05/09		10/04→ 03/09; für Linkslenker; +PR 1AC / 1AT		03.7863-3232.4 300307	ATE Ø 10" pneumatisch
 Hauptbremszylinder							
1.4 16V 1.4 TSI →	63 92	05/06→05/09 11/07→05/09		→ 03/09; für Linkslenker		03.2122-2129.3 010799	ATE Ø 22,2











	kw					! #		
SEAT - TOLEDO III (5P2) 04/04→05/09								
 Hauptbremszylinder								
1.6	75	10/04→05/09		→ 03/09; für Rechtslenker		24.2122-1981.3	011024	ATE Ø 22,2 ohne Bremsflüssigkeitsbehälter
1.8 TFSI	118	01/07→05/09						
1.9 TDI	77	10/04→05/09						
2.0 FSI	110	10/04→05/09						
2.0 TDI	103 - 125	11/05→05/09						
2.0 TFSI	147	11/05→05/09						
2.0 TDI	100	09/04→05/09		10/04→ 03/09; für Linkslenker		03.2122-2129.3	010799	ATE Ø 22,2
2.0 TDI 16V	103	04/04→05/09		10/04→ 03/09; für Rechtslenker		24.2122-1981.3	011024	ATE Ø 22,2 ohne Bremsflüssigkeitsbehälter
Drucksensor, Bremskraftverstärker								
1.4 16V	63	05/06→05/09		→ 03/09; für Linkslenker; +PR 1AS		03.0655-0101.2	370008	ATE
1.4 TSI	92	11/07→05/09						
1.6	75	10/04→05/09						
1.8 TFSI	118	01/07→05/09						
1.9 TDI	77	10/04→05/09						
2.0 FSI	110	10/04→05/09						
2.0 TDI	103 - 125	11/05→05/09						
2.0 TFSI	147	11/05→05/09						
2.0 TDI	100	09/04→05/09		10/04→ 03/09; für Linkslenker; +PR 1AS		03.0655-0101.2	370008	ATE
2.0 TDI 16V	103	04/04→05/09						
SKODA - CITIGO (NF1) 10/11→08/19								
 Hauptbremszylinder								
1.0	44 - 55	10/11→08/19		05/12→		24.4120-1703.3	011015	TRW Ø 20,6 ohne Bremsflüssigkeitsbehälter
1.0 CNG	50	11/12→08/19				24.4120-1703.3	011015	TRW Ø 20,6 ohne Bremsflüssigkeitsbehälter
SKODA - FABIA I (6Y2) 08/99→03/08								
 Hauptbremszylinder								
1.0	37	12/99→08/02		02/00→; + ABS		24.2120-1734.3	010702	Ø 20,6
1.4	50	08/99→05/03		02/00→; - ABS		24.2120-1736.3	010732	Ø 20,6
1.2	40	07/01→04/07		08/02→; + ABS		24.2120-1734.3	010702	Ø 20,6
				08/02→; - ABS		24.2120-1736.3	010732	Ø 20,6
1.2	47	01/03→03/08		→ 12/07; + ABS		24.2120-1734.3	010702	Ø 20,6
1.4 16V	55 - 74	12/99→03/08		→ 12/07; - ABS		24.2120-1736.3	010732	Ø 20,6
1.4 TDI	51 - 59	04/03→03/08						
1.9 SDI	47	12/99→03/08						
2.0	85	12/99→03/08						
1.4	44 - 59	08/00→10/06		+ ABS		24.2120-1734.3	010702	Ø 20,6
				- ABS		24.2120-1736.3	010732	Ø 20,6
1.9 TDI	74	01/00→03/08		02/00→ 12/07; + ABS		24.2120-1734.3	010702	Ø 20,6
				02/00→ 12/07; - ABS		24.2120-1736.3	010732	Ø 20,6
1.9 TDI RS	96	06/03→03/08		09/03→ 12/07; + ABS		24.2120-1734.3	010702	Ø 20,6
				09/03→ 12/07; - ABS		24.2120-1736.3	010732	Ø 20,6
 Bremskraftregler								
1.4	44 - 59	08/00→10/06		+PR 1AL; - ABS; Schrägheck		03.6583-0216.3	320247	ATE lastabhängig 8/3 4x
1.4	50	08/99→05/03		02/00→; +PR 1AL; - ABS; Schrägheck		03.6583-0216.3	320247	ATE lastabhängig 8/3 4x
1.4 16V	55 - 74	12/99→03/08		→ 12/07; +PR 1AL; - ABS; Schrägheck		03.6583-0216.3	320247	ATE lastabhängig 8/3 4x
1.4 TDI	51 - 59	04/03→03/08						
1.9 SDI	47	12/99→03/08						
2.0	85	12/99→03/08						
1.9 TDI	74	01/00→03/08		02/00→ 12/07; +PR 1AL; - ABS; Schrägheck		03.6583-0216.3	320247	ATE lastabhängig 8/3 4x
1.9 TDI RS	96	06/03→03/08		09/03→ 12/07; +PR 1AL; - ABS; Schrägheck		03.6583-0216.3	320247	ATE lastabhängig 8/3 4x
SKODA - FABIA I Combi (6Y5) 04/00→12/07								
 Hauptbremszylinder								
1.2	40	07/01→12/07		08/02→; + ABS		24.2120-1734.3	010702	Ø 20,6
				08/02→; - ABS		24.2120-1736.3	010732	Ø 20,6
1.2	47	01/03→12/07		+ ABS		24.2120-1734.3	010702	Ø 20,6
→								

	kw			 	! #		
SKODA - FABIA I Combi (6Y5) 04/00→12/07							
 Hauptbremszylinder							
1.4	44 - 50	04/00→05/03		- ABS		24.2120-1736.3 010732	Ø 20,6
1.4 16V	55 - 74	04/00→12/07					
1.4 TDI	51 - 59	04/03→12/07					
1.9 SDI	47	04/00→12/07					
1.9 TDI	74	04/00→12/07					
2.0	85	04/00→12/07					
 Bremskraftregler							
1.4	44 - 50	04/00→05/03		+PR 1AL; - ABS; Schrägheck		03.6583-0216.3 320247	ATE lastabhängig 8/3 4x
1.4 16V	55 - 74	04/00→12/07					
1.4 TDI	51 - 59	04/03→12/07					
1.9 SDI	47	04/00→12/07					
1.9 TDI	74	04/00→12/07					
2.0	85	04/00→12/07					
SKODA - FABIA I Praktik (6Y5) 01/00→12/07							
 Hauptbremszylinder							
1.2	40	07/01→12/07		08/02→; + ABS		24.2120-1734.3 010702	Ø 20,6
				08/02→; - ABS		24.2120-1736.3 010732	Ø 20,6
1.2	47	01/03→12/07		+ ABS		24.2120-1734.3 010702	Ø 20,6
1.4	44 - 55	04/00→12/07		- ABS		24.2120-1736.3 010732	Ø 20,6
1.4 TDI	51 - 55	08/04→12/07					
1.9 SDI	47	07/01→12/07					
1.9 TDI	74	01/00→12/07		02/00→; + ABS		24.2120-1734.3 010702	Ø 20,6
				02/00→; - ABS		24.2120-1736.3 010732	Ø 20,6
 Bremskraftregler							
1.4	44 - 55	04/00→12/07		+PR 1AL; - ABS; Schrägheck		03.6583-0216.3 320247	ATE lastabhängig 8/3 4x
1.4 TDI	51 - 55	08/04→12/07					
1.9 SDI	47	07/01→12/07					
1.9 TDI	74	01/00→12/07		02/00→; +PR 1AL; - ABS; Schrägheck		03.6583-0216.3 320247	ATE lastabhängig 8/3 4x
SKODA - FABIA I Stufenheck (6Y3) 10/99→12/07							
 Hauptbremszylinder							
1.2	40	07/01→12/07		08/02→; + ABS		24.2120-1734.3 010702	Ø 20,6
				08/02→; - ABS		24.2120-1736.3 010732	Ø 20,6
1.2	47	01/03→12/07		+ ABS		24.2120-1734.3 010702	Ø 20,6
1.4	44 - 50	04/00→05/03		- ABS		24.2120-1736.3 010732	Ø 20,6
1.4 16V	55 - 74	10/99→12/07					
1.4 TDI	51 - 59	04/03→12/07					
2.0	85	12/99→12/07					
1.9 SDI	47	11/99→12/07		12/99→; + ABS		24.2120-1734.3 010702	Ø 20,6
				12/99→; - ABS		24.2120-1736.3 010732	Ø 20,6
1.9 TDI	74	01/00→12/07		02/00→; + ABS		24.2120-1734.3 010702	Ø 20,6
				02/00→; - ABS		24.2120-1736.3 010732	Ø 20,6
 Bremskraftregler							
1.4	44 - 50	04/00→05/03		+PR 1AL; - ABS; Schrägheck		03.6583-0216.3 320247	ATE lastabhängig 8/3 4x
1.4 16V	55 - 74	10/99→12/07					
1.4 TDI	51 - 59	04/03→12/07					
2.0	85	12/99→12/07					
1.9 SDI	47	11/99→12/07		12/99→; +PR 1AL; - ABS; Schrägheck		03.6583-0216.3 320247	ATE lastabhängig 8/3 4x
1.9 TDI	74	01/00→12/07		02/00→; +PR 1AL; - ABS; Schrägheck		03.6583-0216.3 320247	ATE lastabhängig 8/3 4x













	kw			 	! #		
SKODA - FABIA II (542) 12/06→12/14							
 Hauptbremszylinder							
1.2	44	12/06→12/14		03/07→06/14; +PR 1AL / 1LB / 1LM; für Linkslenker; - ABS	24.2119-1716.3	011120	FTE Ø 19 ohne Bremsflüssigkeitsbehälter
				03/07→06/14; +PR 1LN / 1LQ / 1LR; für Linkslenker; + ABS	24.2120-1734.3	010702	Ø 20,6
				03/07→06/14; +PR 1AL / 1LQ / 1LN / 1LR; für Linkslenker; - ABS	24.2120-1736.3	010732	Ø 20,6
1.2 1.4 1.4 LPG	51 63 63	01/07→12/14 01/07→12/14 01/07→11/14		03/07→06/14; +PR 1AL / 1LB / 1LM; für Linkslenker; - ABS	24.2119-1716.3	011120	FTE Ø 19 ohne Bremsflüssigkeitsbehälter
				03/07→06/14; +PR 1AC / 1AR / 1AT / 1LN / 1LQ / 1LR; für Linkslenker; + ABS	24.2120-1734.3	010702	Ø 20,6
				03/07→06/14; +PR 1AL / 1LQ / 1LN / 1LR; für Linkslenker; - ABS	24.2120-1736.3	010732	Ø 20,6
1.2 12V	44	11/11→12/14		→ 06/14; +PR 1AL / 1LB / 1LM; für Linkslenker; - ABS	24.2119-1716.3	011120	FTE Ø 19 ohne Bremsflüssigkeitsbehälter
				→ 06/14; +PR 1LN / 1LQ / 1LR; für Linkslenker; + ABS	24.2120-1734.3	010702	Ø 20,6
				→ 06/14; +PR 1AL / 1LQ / 1LN / 1LR; für Linkslenker; - ABS	24.2120-1736.3	010732	Ø 20,6
1.2 12V 1.2 LPG	55 44	10/10→12/14 03/09→11/11		+PR 1AL / 1LB / 1LM; für Linkslenker; - ABS	24.2119-1716.3	011120	FTE Ø 19 ohne Bremsflüssigkeitsbehälter
				für Linkslenker; +PR 1AC / 1AR / 1AT / 1LN / 1LQ / 1LR; + ABS	24.2120-1734.3	010702	Ø 20,6
				+PR 1AL / 1LQ / 1LN / 1LR; für Linkslenker; - ABS	24.2120-1736.3	010732	Ø 20,6
1.2 LPG 1.2 TSI	51 63 - 77	07/07→11/14 03/10→12/14		→ 06/14; +PR 1AL / 1LB / 1LM; für Linkslenker; - ABS	24.2119-1716.3	011120	FTE Ø 19 ohne Bremsflüssigkeitsbehälter
1.4 TSI RS 1.6	132 77	05/10→12/14 04/07→12/14		→ 06/14; +PR 1AC / 1AR / 1AT / 1LN / 1LQ / 1LR; für Linkslenker; + ABS	24.2120-1734.3	010702	Ø 20,6
				→ 06/14; +PR 1AL / 1LQ / 1LN / 1LR; für Linkslenker; - ABS	24.2120-1736.3	010732	Ø 20,6
1.2 TDI 1.6 TDI	55 55 - 77	05/10→12/14 03/10→12/14		→ 06/14; +PR 1AL / 1LB / 1LM; für Linkslenker; - ABS	24.2119-1716.3	011120	FTE Ø 19 ohne Bremsflüssigkeitsbehälter
				→ 06/14; +PR 1AC / 1AR / 1AT / 1LN / 1LQ / 1LR; für Linkslenker; + ABS	24.2120-1734.3	010702	Ø 20,6
				→ 06/14; +PR 1AL / 1LQ / 1LN / 1LR; für Linkslenker; - ABS	24.2120-1736.3	010732	Ø 20,6
				→ 06/14; +PR 1AC / 1AR / 1AT / 1LN / 1LQ / 1LR; für Rechtslenker; + ABS; für Fahrzeuge mit Rußpartikelfilter	24.2120-1768.3	011041	Ø 20,6 ohne Bremsflüssigkeitsbehälter
1.4 TDI	51 - 59	01/07→03/10		03/07→; +PR 1AL / 1LB / 1LM; für Linkslenker; - ABS	24.2119-1716.3	011120	FTE Ø 19 ohne Bremsflüssigkeitsbehälter
				03/07→; +PR 1AC / 1AR / 1AT / 1LN / 1LQ / 1LR; für Linkslenker; + ABS	24.2120-1734.3	010702	Ø 20,6
				03/07→; +PR 1AL / 1LQ / 1LN / 1LR; für Linkslenker; - ABS	24.2120-1736.3	010732	Ø 20,6
				03/07→; +PR 1AC / 1AR / 1AT / 1LN / 1LQ / 1LR; für Rechtslenker; + ABS; für Fahrzeuge mit Rußpartikelfilter	24.2120-1768.3	011041	Ø 20,6 ohne Bremsflüssigkeitsbehälter
1.9 TDI	77	04/07→03/10		+PR 1AL / 1LB / 1LM; für Linkslenker; - ABS	24.2119-1716.3	011120	FTE Ø 19 ohne Bremsflüssigkeitsbehälter
				für Linkslenker; +PR 1AC / 1AR / 1AT / 1LN / 1LQ / 1LR; + ABS	24.2120-1734.3	010702	Ø 20,6
				+PR 1AL / 1LQ / 1LN / 1LR; für Linkslenker; - ABS	24.2120-1736.3	010732	Ø 20,6
				für Rechtslenker; +PR 1AC / 1AR / 1AT / 1LN / 1LQ / 1LR; + ABS; für Fahrzeuge mit Rußpartikelfilter	24.2120-1768.3	011041	Ø 20,6 ohne Bremsflüssigkeitsbehälter
 Bremskraftregler							
1.2 1.4 1.4 LPG	44 - 51 63 63	12/06→12/14 01/07→12/14 01/07→11/14		03/07→06/14; - ABS	03.6583-0216.3	320247	ATE lastabhängig 8/3 4x
1.2 12V 1.2 LPG 1.2 TDI 1.2 TSI	44 51 55 63 - 77	11/11→12/14 07/07→11/14 05/10→12/14 03/10→12/14		→ 06/14; - ABS	03.6583-0216.3	320247	ATE lastabhängig 8/3 4x
1.6 1.6 TDI	77 55 - 77	04/07→12/14 03/10→12/14					
1.2 12V 1.2 LPG 1.9 TDI	55 44 77	10/10→12/14 03/09→11/11 04/07→03/10		- ABS	03.6583-0216.3	320247	ATE lastabhängig 8/3 4x
→							







	kw			 	! #		
SKODA - FABIA II (542) 12/06→12/14							
 Bremskraftregler							
1.4 TDI	51 - 59	01/07→03/10		03/07→; - ABS		03.6583-0216.3 320247	ATE lastabhängig 8/3 4x
SKODA - FABIA II Combi (545) 10/07→12/14							
 Hauptbremszylinder							
1.2 1.2 12V	44 44	10/07→11/14 11/11→12/14		→ 06/14; +PR 1AL / 1LB / 1LM; für Linkslenker; - ABS		24.2119-1716.3 011120	FTE Ø 19 ohne Bremsflüssigkeitsbehälter
				→ 06/14; +PR 1LN / 1LQ / 1LR; für Linkslenker; + ABS		24.2120-1734.3 010702	Ø 20,6
				→ 06/14; +PR 1AL / 1LQ / 1LN / 1LR; für Linkslenker; - ABS		24.2120-1736.3 010732	Ø 20,6
1.2 1.2 LPG 1.2 TSI	51 51 63 - 77	10/07→12/14 10/07→11/14 03/10→12/14		→ 06/14; +PR 1AL / 1LB / 1LM; für Linkslenker; - ABS		24.2119-1716.3 011120	FTE Ø 19 ohne Bremsflüssigkeitsbehälter
				→ 06/14; +PR 1AC / 1AR / 1AT / 1LN / 1LQ / 1LR; für Linkslenker; + ABS		24.2120-1734.3 010702	Ø 20,6
1.4 1.4 LPG 1.4 TSI RS 1.6	63 63 132 77	10/07→12/14 10/07→11/14 05/10→12/14 10/07→12/14		→ 06/14; +PR 1AL / 1LQ / 1LN / 1LR; für Linkslenker; - ABS		24.2120-1736.3 010732	Ø 20,6
1.2 LPG	44	03/09→11/11		+PR 1AL / 1LB / 1LM; für Linkslenker; - ABS		24.2119-1716.3 011120	FTE Ø 19 ohne Bremsflüssigkeitsbehälter
				für Linkslenker; +PR 1AC / 1AR / 1AT / 1LN / 1LQ / 1LR; + ABS		24.2120-1734.3 010702	Ø 20,6
				+PR 1AL / 1LQ / 1LN / 1LR; für Linkslenker; - ABS		24.2120-1736.3 010732	Ø 20,6
1.2 TDI 1.6 TDI	55 55 - 77	05/10→12/14 03/10→12/14		→ 06/14; +PR 1AL / 1LB / 1LM; für Linkslenker; - ABS		24.2119-1716.3 011120	FTE Ø 19 ohne Bremsflüssigkeitsbehälter
				→ 06/14; +PR 1AC / 1AR / 1AT / 1LN / 1LQ / 1LR; für Linkslenker; + ABS		24.2120-1734.3 010702	Ø 20,6
				→ 06/14; +PR 1AL / 1LQ / 1LN / 1LR; für Linkslenker; - ABS		24.2120-1736.3 010732	Ø 20,6
				→ 06/14; +PR 1AC / 1AR / 1AT / 1LN / 1LQ / 1LR; für Rechtslenker; + ABS; für Fahrzeuge mit Rußpartikelfilter		24.2120-1768.3 011041	Ø 20,6 ohne Bremsflüssigkeitsbehälter
1.4 TDI 1.9 TDI	51 - 59 77	10/07→03/10 10/07→03/10		+PR 1AL / 1LB / 1LM; für Linkslenker; - ABS		24.2119-1716.3 011120	FTE Ø 19 ohne Bremsflüssigkeitsbehälter
				für Linkslenker; +PR 1AC / 1AR / 1AT / 1LN / 1LQ / 1LR; + ABS		24.2120-1734.3 010702	Ø 20,6
				+PR 1AL / 1LQ / 1LN / 1LR; für Linkslenker; - ABS		24.2120-1736.3 010732	Ø 20,6
				für Rechtslenker; +PR 1AC / 1AR / 1AT / 1LN / 1LQ / 1LR; + ABS; für Fahrzeuge mit Rußpartikelfilter		24.2120-1768.3 011041	Ø 20,6 ohne Bremsflüssigkeitsbehälter
 Bremskraftregler							
1.2 1.2 12V 1.2 LPG 1.2 TDI 1.2 TSI 1.4 1.4 LPG 1.6 1.6 TDI	44 - 51 44 51 55 63 - 77 63 63 77 55 - 77	10/07→12/14 11/11→12/14 10/07→11/14 05/10→12/14 03/10→12/14 10/07→12/14 10/07→11/14 10/07→12/14 03/10→12/14		→ 06/14; - ABS		03.6583-0216.3 320247	ATE lastabhängig 8/3 4x
1.2 LPG 1.4 TDI 1.9 TDI	44 51 - 59 77	03/09→11/11 10/07→03/10 10/07→03/10		- ABS		03.6583-0216.3 320247	ATE lastabhängig 8/3 4x
SKODA - FELICIA I Pick-up (6UF, 6U7) 10/95→04/02							
 Hauptbremszylinder							
1.3	40	06/97→04/02		→ 12/00; - ABS		24.2122-1731.3 010656	Ø 22,2
1.3	43	10/95→04/02		06/97→ 12/00; - ABS		24.2122-1731.3 010656	Ø 22,2
1.3 1.9 D	50 47	06/97→04/02 06/97→04/02		→ 12/00		24.2122-1731.3 010656	Ø 22,2
1.6	55	06/97→04/02		→ 12/99		24.2122-1731.3 010656	Ø 22,2
 Bremskraftregler							
1.3	40 - 50	06/97→04/02		→ 12/00		03.6584-0107.3 320110	ATE lastabhängig 8/4 4x
1.3	43	10/95→04/02		06/97→ 12/00		03.6584-0107.3 320110	ATE lastabhängig 8/4 4x
→							







	kw					! #		
SKODA - FELICIA I Pick-up (6UF, 6U7) 10/95→04/02								
 Bremskraftregler								
1.6	55	06/97→04/02		→ 12/99		03.6584-0107.3	320110	ATE lastabhängig 8/4 4x
1.9 D	47	06/97→04/02		→ 12/00		03.6583-0167.3	320140	ATE lastabhängig 8/3 4x
SKODA - KAROQ (NU7, ND7) 07/17→								
 Hauptbremszylinder								
1.0 TSI	81 - 85	07/17→		für Linkslenker		24.4123-1719.3	011017	TRW Ø 23,8 ohne Bremsflüssigkeitsbehälter
1.4 TSI	110	07/17→				24.4153-1522.3	011048	ATE Ø 23,8 ohne Bremsflüssigkeitsbehälter
1.4 TSI 4x4	110	09/19→						
1.5 TSI	110	07/17→						
1.5 TSI 4x4	110	07/17→						
1.6 SRE	81	07/17→						
1.6 TDI	85	07/17→						
2.0 TDI	85 - 110	07/17→						
2.0 TDI 4x4	110 - 140	07/17→						
2.0 TSI 4x4	140	04/19→						
SKODA - KODIAQ (NS6, NS7, NV7) 10/16→								
 Hauptbremszylinder								
1.4 TSI	92 - 110	10/16→		für Linkslenker; +PR 1ZA		24.4123-1719.3	011017	TRW Ø 23,8 ohne Bremsflüssigkeitsbehälter
1.4 TSI 4x4	110	10/16→						
1.5 TSI	110	07/18→						
1.5 TSI 4x4	110	07/18→						
2.0 RS 4x4	180	06/21→						
2.0 RS Bi-TDI 4x4	176	11/18→						
2.0 TDI	85 - 110	10/16→						
2.0 TDI 4x4	110 - 147	10/16→						
2.0 TSI 4x4	132 - 140	10/16→						
SKODA - OCTAVIA I (1U2) 09/96→12/10								
 Bremskraftverstärker								
1.4	44	04/99→03/01		→ 07/00; für Linkslenker; + ESP		03.7863-0402.4	300124	ATE Ø 10" pneumatisch
1.4 16V	55	09/00→12/10		05/01→ 06/10; +PR 1AC / 1AH / 1AJ / 1AT; für Linkslenker		03.7863-3502.4	300128	ATE Ø 10" pneumatisch
1.6	75	11/00→12/10						
1.6	55	09/96→09/04		10/96→ 07/00; für Linkslenker; + ESP		03.7863-0402.4	300124	ATE Ø 10" pneumatisch
1.9 TDI	66	09/96→03/10		05/01→; +PR 1AC / 1AH / 1AJ / 1AT; für Linkslenker		03.7863-3502.4	300128	ATE Ø 10" pneumatisch
1.6	74	02/97→12/07		→ 07/00; für Linkslenker; + ESP		03.7863-0402.4	300124	ATE Ø 10" pneumatisch
1.9 SDI	50	06/97→12/03						
1.9 TDI	81	08/97→01/06		05/01→; +PR 1AC / 1AH / 1AJ / 1AT; für Linkslenker		03.7863-3502.4	300128	ATE Ø 10" pneumatisch
2.0	85	04/99→05/07						
1.8	92	09/96→07/00		10/96→; für Linkslenker; + ESP		03.7863-0402.4	300124	ATE Ø 10" pneumatisch
1.8 T	110	08/97→12/10		03/98→ 07/00; für Linkslenker; + ESP		03.7863-0402.4	300124	ATE Ø 10" pneumatisch
				05/01→ 06/10; +PR 1AC / 1AH / 1AJ / 1AT; für Linkslenker		03.7863-3502.4	300128	ATE Ø 10" pneumatisch
1.8 T 4x4	110	05/01→05/06		+PR 1AC / 1AH / 1AJ / 1AT; für Linkslenker		03.7863-3502.4	300128	ATE Ø 10" pneumatisch
RS 1.8 T	132	05/01→01/06						
1.9 TDI	74	10/05→12/10		→ 06/10; +PR 1AC / 1AH / 1AJ / 1AT; für Linkslenker		03.7863-3502.4	300128	ATE Ø 10" pneumatisch
1.9 TDI	96	09/02→09/04		01/03→; +PR 1AC / 1AH / 1AJ / 1AT; für Linkslenker		03.7863-3502.4	300128	ATE Ø 10" pneumatisch
 Hauptbremszylinder								
1.4	44	04/99→03/01		→ 07/00; für Linkslenker; + ESP		03.2123-2024.3	010597	ATE Ø 23,8
1.6	74	02/97→12/07						
1.9 SDI	50	06/97→12/03		08/00→; für Linkslenker; +PR 1AT		03.2123-2715.3	010802	ATE Ø 23,8
1.9 TDI	81	08/97→01/06		08/00→; für Rechtslenker; +PR 1AT		03.2123-2774.3	010803	ATE Ø 23,8
2.0	85	04/99→05/07		08/00→; für Linkslenker; +PR 1AC / 1AH / 1AJ		03.2123-2973.3	010951	ATE Ø 23,8
				08/00→; für Linkslenker; +PR 1AM		24.2123-1709.3	010503	Ø 23,8
				→ 07/00; für Linkslenker; - ESP		24.2123-1709.3	010503	Ø 23,8
1.4 16V	55	09/00→12/10		→ 06/10; für Linkslenker; +PR 1AT		03.2123-2715.3	010802	ATE Ø 23,8
1.6	75	11/00→12/10		→ 06/10; für Rechtslenker; +PR 1AT		03.2123-2774.3	010803	ATE Ø 23,8
1.9 TDI	74	10/05→12/10		→ 06/10; für Linkslenker; +PR 1AC / 1AH / 1AJ		03.2123-2973.3	010951	ATE Ø 23,8
				→ 06/10; für Linkslenker; +PR 1AM		24.2123-1709.3	010503	Ø 23,8
1.6	55	09/96→09/04		10/96→ 07/00; für Linkslenker; + ESP		03.2123-2024.3	010597	ATE Ø 23,8
→								









	kw				! #		
SKODA - OCTAVIA I (1U2) 09/96→12/10							
 Hauptbremszylinder							
1.9 TDI	66	09/96→03/10		08/00→; für Linkslenker; +PR 1AT	03.2123-2715.3	010802	ATE Ø 23,8
				08/00→; für Rechtslenker; +PR 1AT	03.2123-2774.3	010803	ATE Ø 23,8
				08/00→; für Linkslenker; +PR 1AC / 1AH / 1AJ	03.2123-2973.3	010951	ATE Ø 23,8
				08/00→; für Linkslenker; +PR 1AM	24.2123-1709.3	010503	Ø 23,8
				10/96→ 07/00; für Linkslenker; - ESP	24.2123-1709.3	010503	Ø 23,8
1.8	92	09/96→07/00		10/96→; für Linkslenker; + ESP	03.2123-2024.3	010597	ATE Ø 23,8
				10/96→; für Linkslenker; - ESP	24.2123-1709.3	010503	Ø 23,8
1.8 T	110	08/97→12/10		03/98→ 07/00; für Linkslenker; + ESP	03.2123-2024.3	010597	ATE Ø 23,8
				08/00→ 06/10; für Linkslenker; +PR 1AT	03.2123-2715.3	010802	ATE Ø 23,8
				08/00→ 06/10; für Rechtslenker; +PR 1AT	03.2123-2774.3	010803	ATE Ø 23,8
				08/00→ 06/10; für Linkslenker; +PR 1AC / 1AH / 1AJ	03.2123-2973.3	010951	ATE Ø 23,8
				08/00→ 06/10; für Linkslenker; +PR 1AM	24.2123-1709.3	010503	Ø 23,8
1.8 T 4x4 RS 1.8 T	110 132	05/01→05/06 05/01→01/06		für Linkslenker; +PR 1AT	03.2123-2715.3	010802	ATE Ø 23,8
				für Rechtslenker; +PR 1AT	03.2123-2774.3	010803	ATE Ø 23,8
				für Linkslenker; +PR 1AC / 1AH / 1AJ	03.2123-2973.3	010951	ATE Ø 23,8
				für Linkslenker; +PR 1AM	24.2123-1709.3	010503	Ø 23,8
1.9 TDI	96	09/02→09/04		01/03→; für Linkslenker; +PR 1AT	03.2123-2715.3	010802	ATE Ø 23,8
				01/03→; für Rechtslenker; +PR 1AT	03.2123-2774.3	010803	ATE Ø 23,8
				01/03→; für Linkslenker; +PR 1AC / 1AH / 1AJ	03.2123-2973.3	010951	ATE Ø 23,8
				01/03→; für Linkslenker; +PR 1AM	24.2123-1709.3	010503	Ø 23,8
 Bremskraftregler							
1.4	44	04/99→03/01		Trommelbremse	03.6584-0107.3	320110	ATE lastabhängig 8/4 4x
1.6	74	02/97→12/07					
1.9 SDI	50	06/97→12/03					
1.4 16V	55	09/00→12/10		→ 06/10; Trommelbremse	03.6584-0107.3	320110	ATE lastabhängig 8/4 4x
1.6	75	11/00→12/10					
1.6	55	09/96→09/04		10/96→; Trommelbremse	03.6584-0107.3	320110	ATE lastabhängig 8/4 4x
1.9 TDI	66	09/96→03/10					
SKODA - OCTAVIA I Combi (1U5) 07/98→12/10							
 Bremskraftverstärker							
1.4 16V	55	08/00→12/10		05/01→ 06/10; +PR 1AC / 1AH / 1AJ / 1AT; für Linkslenker	03.7863-3502.4	300128	ATE Ø 10" pneumatisch
1.6	75	09/00→12/10					
1.9 TDI	74	08/00→12/10					
1.6	55 - 74	07/98→12/07		→ 07/00; für Linkslenker; + ESP	03.7863-0402.4	300124	ATE Ø 10" pneumatisch
1.9 SDI	50	07/98→12/03		05/01→; +PR 1AC / 1AH / 1AJ / 1AT; für Linkslenker	03.7863-3502.4	300128	ATE Ø 10" pneumatisch
1.9 TDI	66 - 81	07/98→03/10					
1.9 TDI 4x4	66	11/99→02/06					
2.0	85	04/99→05/07					
1.8 20V	92	07/98→07/00		für Linkslenker; + ESP	03.7863-0402.4	300124	ATE Ø 10" pneumatisch
1.8 T	110	07/98→12/10		→ 07/00; für Linkslenker; + ESP	03.7863-0402.4	300124	ATE Ø 10" pneumatisch
				05/01→ 06/10; +PR 1AC / 1AH / 1AJ / 1AT; für Linkslenker	03.7863-3502.4	300128	ATE Ø 10" pneumatisch
1.8 T 4x4 RS 1.8 T	110 132	05/01→05/06 08/02→01/06		+PR 1AC / 1AH / 1AJ / 1AT; für Linkslenker	03.7863-3502.4	300128	ATE Ø 10" pneumatisch
1.9 TDI	96	09/02→09/04		01/03→; +PR 1AC / 1AH / 1AJ / 1AT; für Linkslenker	03.7863-3502.4	300128	ATE Ø 10" pneumatisch
1.9 TDI 4x4 2.0 4x4	74 85	09/00→01/06 08/00→09/04		05/01→; +PR 1AC / 1AH / 1AJ / 1AT; für Linkslenker	03.7863-3502.4	300128	ATE Ø 10" pneumatisch
 Hauptbremszylinder							
1.4 16V	55	08/00→12/10		→ 06/10; für Linkslenker; +PR 1AT	03.2123-2715.3	010802	ATE Ø 23,8
1.6	75	09/00→12/10		→ 06/10; für Rechtslenker; +PR 1AT	03.2123-2774.3	010803	ATE Ø 23,8
1.9 TDI	74	08/00→12/10		→ 06/10; für Linkslenker; +PR 1AC / 1AH / 1AJ	03.2123-2973.3	010951	ATE Ø 23,8
				→ 06/10; für Linkslenker; +PR 1AM	24.2123-1709.3	010503	Ø 23,8
1.6	55 - 74	07/98→12/07		→ 07/00; für Linkslenker; + ESP	03.2123-2024.3	010597	ATE Ø 23,8
1.9 SDI	50	07/98→12/03		08/00→; für Linkslenker; +PR 1AT	03.2123-2715.3	010802	ATE Ø 23,8
1.9 TDI	66 - 81	07/98→03/10		08/00→; für Rechtslenker; +PR 1AT	03.2123-2774.3	010803	ATE Ø 23,8
1.9 TDI 4x4	66	11/99→02/06		08/00→; für Linkslenker; +PR 1AC / 1AH / 1AJ	03.2123-2973.3	010951	ATE Ø 23,8

























	kw					! #		
SKODA - OCTAVIA I Combi (1U5) 07/98→12/10								
 Hauptbremszylinder								
2.0	85	04/99→05/07		08/00→; für Linkslenker; +PR 1AM		24.2123-1709.3	010503	Ø 23,8
				→ 07/00; für Linkslenker; - ESP		24.2123-1709.3	010503	Ø 23,8
1.8 20V	92	07/98→07/00		für Linkslenker; + ESP		03.2123-2024.3	010597	ATE Ø 23,8
				für Linkslenker; - ESP		24.2123-1709.3	010503	Ø 23,8
1.8 T	110	07/98→12/10		→ 07/00; für Linkslenker; + ESP		03.2123-2024.3	010597	ATE Ø 23,8
				08/00→ 06/10; für Linkslenker; +PR 1AT		03.2123-2715.3	010802	ATE Ø 23,8
				08/00→ 06/10; für Rechtslenker; +PR 1AT		03.2123-2774.3	010803	ATE Ø 23,8
				08/00→ 06/10; für Linkslenker; +PR 1AC / 1AH / 1AJ		03.2123-2973.3	010951	ATE Ø 23,8
				08/00→ 06/10; für Linkslenker; +PR 1AM		24.2123-1709.3	010503	Ø 23,8
				→ 07/00; für Linkslenker; - ESP		24.2123-1709.3	010503	Ø 23,8
1.8 T 4x4 1.9 TDI 4x4 RS 1.8 T	110 74 132	05/01→05/06 09/00→01/06 08/02→01/06		für Linkslenker; +PR 1AT		03.2123-2715.3	010802	ATE Ø 23,8
				für Rechtslenker; +PR 1AT		03.2123-2774.3	010803	ATE Ø 23,8
				für Linkslenker; +PR 1AC / 1AH / 1AJ		03.2123-2973.3	010951	ATE Ø 23,8
				für Linkslenker; +PR 1AM		24.2123-1709.3	010503	Ø 23,8
1.9 TDI	96	09/02→09/04		01/03→; für Linkslenker; +PR 1AT		03.2123-2715.3	010802	ATE Ø 23,8
				01/03→; für Rechtslenker; +PR 1AT		03.2123-2774.3	010803	ATE Ø 23,8
				01/03→; für Linkslenker; +PR 1AC / 1AH / 1AJ		03.2123-2973.3	010951	ATE Ø 23,8
				01/03→; für Linkslenker; +PR 1AM		24.2123-1709.3	010503	Ø 23,8
2.0 4x4	85	08/00→09/04		05/01→; für Linkslenker; +PR 1AT		03.2123-2715.3	010802	ATE Ø 23,8
				05/01→; für Rechtslenker; +PR 1AT		03.2123-2774.3	010803	ATE Ø 23,8
				05/01→; für Linkslenker; +PR 1AC / 1AH / 1AJ		03.2123-2973.3	010951	ATE Ø 23,8
				05/01→; für Linkslenker; +PR 1AM		24.2123-1709.3	010503	Ø 23,8
 Bremskraftregler								
1.4 16V 1.6	55 75	08/00→12/10 09/00→12/10		→ 06/10; Trommelbremse		03.6584-0107.3	320110	ATE lastabhängig 8/4 4x
1.6 1.9 SDI 1.9 TDI	55 - 74 50 66	07/98→12/07 07/98→12/03 07/98→03/10		Trommelbremse		03.6584-0107.3	320110	ATE lastabhängig 8/4 4x
SKODA - OCTAVIA I Kasten/Kombi (1U5) 08/00→03/10								
 Bremskraftverstärker								
1.9 D 1.9 TDI	50 66	08/00→12/03 08/00→03/10		für Linkslenker; + ESP		03.7863-0402.4	300124	ATE Ø 10" pneumatisch
				05/01→; +PR 1AC / 1AH / 1AJ / 1AT; für Linkslenker		03.7863-3502.4	300128	ATE Ø 10" pneumatisch
 Hauptbremszylinder								
1.9 D 1.9 TDI	50 66	08/00→12/03 08/00→03/10		für Linkslenker; + ESP		03.2123-2024.3	010597	ATE Ø 23,8
				für Linkslenker; +PR 1AT		03.2123-2715.3	010802	ATE Ø 23,8
				für Rechtslenker; +PR 1AT		03.2123-2774.3	010803	ATE Ø 23,8
				für Linkslenker; +PR 1AC / 1AH / 1AJ		03.2123-2973.3	010951	ATE Ø 23,8
				für Linkslenker; - ESP		24.2123-1709.3	010503	Ø 23,8
				für Linkslenker; +PR 1AM		24.2123-1709.3	010503	Ø 23,8
 Bremskraftregler								
1.9 D 1.9 TDI	50 66	08/00→12/03 08/00→03/10		Trommelbremse		03.6584-0107.3	320110	ATE lastabhängig 8/4 4x
SKODA - OCTAVIA II (1Z3) 02/04→06/13								
 Bremskraftverstärker								
1.2 TSI 1.4 1.4 TSI 1.6 1.6 TDI 1.8 TSI 2.0 TDI 2.0 TFSI	77 59 90 75 77 112 - 118 81 147	02/10→06/13 06/04→04/13 11/08→06/13 06/04→06/13 06/09→04/13 06/07→06/13 03/10→06/13 10/05→02/13		→ 01/13; für Linkslenker; +PR 1AC / 1AT		03.7863-3232.4	300307	ATE Ø 10" pneumatisch
1.4 1.6 FSI 2.0 TDI	55 85 100	05/04→05/06 02/04→10/08 02/04→05/10		06/04→; für Linkslenker; +PR 1AC / 1AT		03.7863-3232.4	300307	ATE Ø 10" pneumatisch
1.6 LPG	75	08/09→11/12		09/09→; für Linkslenker; +PR 1AC / 1AT		03.7863-3232.4	300307	ATE Ø 10" pneumatisch
→								













	kw			 	! #		
SKODA - OCTAVIA II (1Z3) 02/04→06/13							
Bremskraftverstärker							
1.6 MultiFuel	75	01/08→06/13		09/09→ 01/13; für Linkslenker; +PR 1AC / 1AT		03.7863-3232.4 300307	ATE Ø 10" pneumatisch
1.9 TDI	77	06/04→12/10		für Linkslenker; +PR 1AC / 1AT		03.7863-3232.4 300307	ATE Ø 10" pneumatisch
2.0 FSI	110	11/04→10/08					
2.0 TDI	103	11/05→05/10					
2.0 TDI RS	125	04/06→02/13					
2.0 TDI 16V	103	02/04→04/13		06/04→ 01/13; für Linkslenker; +PR 1AC / 1AT		03.7863-3232.4 300307	ATE Ø 10" pneumatisch
Hauptbremszylinder							
1.2 TSI	77	02/10→06/13		→ 01/13; für Linkslenker		03.2122-2129.3 010799	ATE Ø 22,2
1.4	59	06/04→04/13		→ 01/13; für Rechtslenker		24.2122-1981.3 011024	ATE Ø 22,2 ohne Bremsflüssigkeitsbehälter
1.4 TSI	90	11/08→06/13					
1.6	75	06/04→06/13					
1.6 TDI	77	06/09→04/13					
1.8 TSI	112 -	06/07→06/13					
	118						
2.0 TDI	81	03/10→06/13					
2.0 TFSI	147	10/05→02/13					
1.4	55	05/04→05/06		06/04→; für Linkslenker		03.2122-2129.3 010799	ATE Ø 22,2
1.6 FSI	85	02/04→10/08		06/04→; für Rechtslenker		24.2122-1981.3 011024	ATE Ø 22,2 ohne Bremsflüssigkeitsbehälter
2.0 TDI	100	02/04→05/10					
1.6 LPG	75	08/09→11/12		09/09→; für Linkslenker		03.2122-2129.3 010799	ATE Ø 22,2
				09/09→; für Rechtslenker		24.2122-1981.3 011024	ATE Ø 22,2 ohne Bremsflüssigkeitsbehälter
1.6 MultiFuel	75	01/08→06/13		09/09→ 01/13; für Linkslenker		03.2122-2129.3 010799	ATE Ø 22,2
				09/09→ 01/13; für Rechtslenker		24.2122-1981.3 011024	ATE Ø 22,2 ohne Bremsflüssigkeitsbehälter
1.9 TDI	77	06/04→12/10		für Linkslenker		03.2122-2129.3 010799	ATE Ø 22,2
2.0 FSI	110	11/04→10/08		für Rechtslenker		24.2122-1981.3 011024	ATE Ø 22,2 ohne Bremsflüssigkeitsbehälter
2.0 TDI	103	11/05→05/10					
2.0 TDI RS	125	04/06→02/13					
2.0 TDI 16V	103	02/04→04/13		06/04→ 01/13; für Linkslenker		03.2122-2129.3 010799	ATE Ø 22,2
				06/04→ 01/13; für Rechtslenker		24.2122-1981.3 011024	ATE Ø 22,2 ohne Bremsflüssigkeitsbehälter
Drucksensor, Bremskraftverstärker							
1.2 TSI	77	02/10→06/13		→ 01/13; für Linkslenker; +PR 1AS		03.0655-0101.2 370008	ATE
1.4	59	06/04→04/13					
1.4 TSI	90	11/08→06/13					
1.6	75	06/04→06/13					
1.6 TDI	77	06/09→04/13					
1.8 TSI	112 -	06/07→06/13					
	118						
2.0 TDI	81	03/10→06/13					
2.0 TFSI	147	10/05→02/13					
1.4	55	05/04→05/06		06/04→; für Linkslenker; +PR 1AS		03.0655-0101.2 370008	ATE
1.6 FSI	85	02/04→10/08					
2.0 TDI	100	02/04→05/10					
1.6 LPG	75	08/09→11/12		09/09→; für Linkslenker; +PR 1AS		03.0655-0101.2 370008	ATE
1.6 MultiFuel	75	01/08→06/13		09/09→ 01/13; für Linkslenker; +PR 1AS		03.0655-0101.2 370008	ATE
1.9 TDI	77	06/04→12/10		für Linkslenker; +PR 1AS		03.0655-0101.2 370008	ATE
2.0 FSI	110	11/04→10/08					
2.0 TDI	103	11/05→05/10					
2.0 TDI RS	125	04/06→02/13					
2.0 TDI 16V	103	02/04→04/13		06/04→ 01/13; für Linkslenker; +PR 1AS		03.0655-0101.2 370008	ATE
SKODA - OCTAVIA II Combi (1Z5) 02/04→06/13							
Bremskraftverstärker							
1.2 TSI	77	02/10→04/13		→ 01/13; für Linkslenker; +PR 1AC / 1AT		03.7863-3232.4 300307	ATE Ø 10" pneumatisch
1.4	59	05/06→06/13					
1.4 TSI	90	11/08→06/13					
1.6	75	09/04→06/13					
1.6 TDI	77	06/09→04/13					
1.6 TDI 4x4	77	06/09→02/13					
1.8 TSI	112 -	06/07→06/13					
	118						
1.8 TSI 4x4	112 -	11/08→02/13					
	118						
2.0 TDI	81	03/10→06/13					
2.0 TDI 16V 4x4	103	05/10→02/13					
2.0 TDI 4x4	81	05/11→02/13					
2.0 TFSI	147	10/05→02/13					
1.4	55	05/04→05/06		06/04→; für Linkslenker; +PR 1AC / 1AT		03.7863-3232.4 300307	ATE Ø 10" pneumatisch
1.6 FSI	85	02/04→10/08					
2.0 TDI 16V	100	02/04→05/10					
→							

















	kw			 	! #						
SKODA - OCTAVIA II Combi (1Z5) 02/04→06/13											
Bremskraftverstärker											
1.6 LPG	75	08/09→11/12		09/09→; für Linkslenker; +PR 1AC / 1AT		03.7863-3232.4 300307	ATE Ø 10" pneumatisch				
1.6 MultiFuel	75	01/08→06/13		09/09→ 01/13; für Linkslenker; +PR 1AC / 1AT		03.7863-3232.4 300307	ATE Ø 10" pneumatisch				
1.9 TDI	77	09/04→12/10		für Linkslenker; +PR 1AC / 1AT		03.7863-3232.4 300307	ATE Ø 10" pneumatisch				
1.9 TDI 4x4	77	11/04→12/10									
2.0 FSI	110	11/04→10/08									
2.0 FSI 4x4	110	11/04→04/09									
2.0 TDI	103	11/05→05/10									
2.0 TDI 4x4	103	07/06→05/10									
2.0 TDI RS	125	04/06→02/13									
2.0 TDI 16V	103	02/04→05/13		06/04→ 01/13; für Linkslenker; +PR 1AC / 1AT		03.7863-3232.4 300307	ATE Ø 10" pneumatisch				
Hauptbremszylinder											
1.2 TSI	77	02/10→04/13		→ 01/13; für Linkslenker		03.2122-2129.3 010799	ATE Ø 22,2				
1.4	59	05/06→06/13		→ 01/13; für Rechtslenker		24.2122-1981.3 011024	ATE Ø 22,2 ohne Bremsflüssigkeitsbehälter				
1.4 TSI	90	11/08→06/13									
1.6	75	09/04→06/13									
1.6 TDI	77	06/09→04/13									
1.6 TDI 4x4	77	06/09→02/13									
1.8 TSI	112 - 118	06/07→06/13									
1.8 TSI 4x4	112 - 118	11/08→02/13									
2.0 TDI	81	03/10→06/13									
2.0 TDI 16V 4x4	103	05/10→02/13									
2.0 TDI 4x4	81	05/11→02/13									
2.0 TFSI	147	10/05→02/13									
1.4	55	05/04→05/06						06/04→; für Linkslenker		03.2122-2129.3 010799	ATE Ø 22,2
1.6 FSI	85	02/04→10/08						06/04→; für Rechtslenker		24.2122-1981.3 011024	ATE Ø 22,2 ohne Bremsflüssigkeitsbehälter
2.0 TDI 16V	100	02/04→05/10									
1.6 LPG	75	08/09→11/12		09/09→; für Linkslenker		03.2122-2129.3 010799	ATE Ø 22,2				
				09/09→; für Rechtslenker		24.2122-1981.3 011024	ATE Ø 22,2 ohne Bremsflüssigkeitsbehälter				
1.6 MultiFuel	75	01/08→06/13		09/09→ 01/13; für Linkslenker		03.2122-2129.3 010799	ATE Ø 22,2				
				09/09→ 01/13; für Rechtslenker		24.2122-1981.3 011024	ATE Ø 22,2 ohne Bremsflüssigkeitsbehälter				
1.9 TDI	77	09/04→12/10		für Linkslenker		03.2122-2129.3 010799	ATE Ø 22,2				
1.9 TDI 4x4	77	11/04→12/10		für Rechtslenker		24.2122-1981.3 011024	ATE Ø 22,2 ohne Bremsflüssigkeitsbehälter				
2.0 FSI	110	11/04→10/08									
2.0 FSI 4x4	110	11/04→04/09									
2.0 TDI	103	11/05→05/10									
2.0 TDI 4x4	103	07/06→05/10									
2.0 TDI RS	125	04/06→02/13									
2.0 TDI 16V	103	02/04→05/13						06/04→ 01/13; für Linkslenker		03.2122-2129.3 010799	ATE Ø 22,2
								06/04→ 01/13; für Rechtslenker		24.2122-1981.3 011024	ATE Ø 22,2 ohne Bremsflüssigkeitsbehälter
Drucksensor, Bremskraftverstärker											
1.2 TSI	77	02/10→04/13		→ 01/13; für Linkslenker; +PR 1AS		03.0655-0101.2 370008	ATE				
1.4	59	05/06→06/13				03.0655-0101.2 370008	ATE				
1.4 TSI	90	11/08→06/13									
1.6	75	09/04→06/13									
1.6 TDI	77	06/09→04/13									
1.6 TDI 4x4	77	06/09→02/13									
1.8 TSI	112 - 118	06/07→06/13									
1.8 TSI 4x4	112 - 118	11/08→02/13									
2.0 TDI	81	03/10→06/13									
2.0 TDI 16V 4x4	103	05/10→02/13									
2.0 TDI 4x4	81	05/11→02/13									
2.0 TFSI	147	10/05→02/13									
1.4	55	05/04→05/06						06/04→; für Linkslenker; +PR 1AS		03.0655-0101.2 370008	ATE
1.6 FSI	85	02/04→10/08						09/09→; für Linkslenker; +PR 1AS		03.0655-0101.2 370008	ATE
2.0 TDI 16V	100	02/04→05/10									
1.6 LPG	75	08/09→11/12		09/09→; für Linkslenker; +PR 1AS		03.0655-0101.2 370008	ATE				
1.6 MultiFuel	75	01/08→06/13		09/09→ 01/13; für Linkslenker; +PR 1AS		03.0655-0101.2 370008	ATE				
1.9 TDI	77	09/04→12/10		für Linkslenker; +PR 1AS		03.0655-0101.2 370008	ATE				
1.9 TDI 4x4	77	11/04→12/10									
2.0 FSI	110	11/04→10/08									
2.0 FSI 4x4	110	11/04→04/09									
2.0 TDI	103	11/05→05/10									
2.0 TDI 4x4	103	07/06→05/10									
2.0 TDI RS	125	04/06→02/13									
2.0 TDI 16V	103	02/04→05/13						06/04→ 01/13; für Linkslenker; +PR 1AS		03.0655-0101.2 370008	ATE















	kw			 	! #		
SKODA - OCTAVIA III (5E3, NL3, NR3) 11/12→03/21							
 Hauptbremszylinder							
1.0 TSI	85	05/16→10/20		für Linkslenker; +PR 1ZA / 1ZB / 1ZE / 1ZF	03.4153-5403.3	010994	ATE Ø 23,8
1.2 TSI	81	05/15→02/17			24.4123-1719.3	011017	TRW Ø 23,8 ohne Bremsflüssigkeitsbehälter
1.5 TSI	110	02/17→10/20					
1.6	81	01/14→10/20			24.4153-1522.3	011048	ATE Ø 23,8 ohne Bremsflüssigkeitsbehälter
1.6 TDI	85	02/17→10/20					
1.6 TDI 4x4	77 - 85	05/13→10/20					
1.8 TSI 4x4	132	05/14→10/20					
2.0 TDI 4x4	110	05/13→10/20					
2.0 TSI	140	02/17→10/20					
2.0 TSI 4x4	140	02/19→10/20					
2.0 TSI RS	169 - 180	05/15→10/20					
1.2 TSI	63 - 77	11/12→02/17		02/13→; für Linkslenker; +PR 1ZA / 1ZB / 1ZE / 1ZF	03.4153-5403.3	010994	ATE Ø 23,8
1.6 TDI	66 - 77	11/12→10/20			24.4123-1719.3	011017	TRW Ø 23,8 ohne Bremsflüssigkeitsbehälter
2.0 TDI	110	11/12→10/20		01/14→; für Linkslenker; +PR 1ZA / 1ZB / 1ZE / 1ZF	24.4153-1522.3	011048	ATE Ø 23,8 ohne Bremsflüssigkeitsbehälter
1.4 TSI	103	11/12→02/17		für Linkslenker; +PR 1ZA / 1ZB / 1ZE / 1ZF	03.4153-5403.3	010994	ATE Ø 23,8
1.4 TSI G-TEC	81	11/13→02/17			24.4123-1719.3	011017	TRW Ø 23,8 ohne Bremsflüssigkeitsbehälter
1.6 TDI	81	05/13→02/17					
1.8 TSI	132	11/12→10/20			24.4153-1522.3	011048	ATE Ø 23,8 ohne Bremsflüssigkeitsbehälter
2.0 TDI	105	11/12→02/17		01/14→; für Linkslenker; +PR 1ZA / 1ZB / 1ZE / 1ZF			
2.0 TDI RS	135	05/13→10/20					
2.0 TSI RS	162	05/13→02/17					
1.4 TSI	110	08/14→10/20		05/15→; für Linkslenker; +PR 1ZA / 1ZB / 1ZE / 1ZF	03.4153-5403.3	010994	ATE Ø 23,8
					24.4123-1719.3	011017	TRW Ø 23,8 ohne Bremsflüssigkeitsbehälter
				für Linkslenker; +PR 1ZA / 1ZB / 1ZE / 1ZF	24.4153-1522.3	011048	ATE Ø 23,8 ohne Bremsflüssigkeitsbehälter
2.0 TDI / TDI RS 4x4	135	05/13→10/20		für Linkslenker; +PR 1ZA / 1ZB / 1ZE / 1ZF	03.4153-5403.3	010994	ATE Ø 23,8
					24.4123-1719.3	011017	TRW Ø 23,8 ohne Bremsflüssigkeitsbehälter
				09/14→; +PR 1ZA / 1ZB / 1ZE / 1ZF; für Linkslenker	24.4153-1522.3	011048	ATE Ø 23,8 ohne Bremsflüssigkeitsbehälter
SKODA - OCTAVIA III Combi (5E5, 5E6) 11/12→10/20							
 Hauptbremszylinder							
1.0 TSI	85	05/16→10/20		+PR 1ZA / 1ZB / 1ZE / 1ZF; für Linkslenker	03.4153-5403.3	010994	ATE Ø 23,8
1.2 TSI	81	05/15→02/17			24.4123-1719.3	011017	TRW Ø 23,8 ohne Bremsflüssigkeitsbehälter
1.5 TSI	110	02/17→10/20					
1.5 TSI G-TEC	96	01/19→10/20			24.4153-1522.3	011048	ATE Ø 23,8 ohne Bremsflüssigkeitsbehälter
1.6 SRE	81	01/14→02/17					
1.6 TDI	85	02/17→10/20					
1.6 TDI 4x4	81 - 85	05/15→10/20					
2.0 TDI / TDI RS 4x4	135	05/13→10/20					
2.0 TSI	140	02/17→10/20					
2.0 TSI 4x4	140	02/19→10/20					
2.0 TSI RS	169 - 180	05/15→10/20					
1.2 TSI	63 - 77	11/12→02/17		02/13→; für Linkslenker; +PR 1ZA / 1ZB / 1ZE / 1ZF	03.4153-5403.3	010994	ATE Ø 23,8
1.6 TDI	66 - 77	11/12→10/20			24.4123-1719.3	011017	TRW Ø 23,8 ohne Bremsflüssigkeitsbehälter
2.0 TDI	110	11/12→10/20		01/14→; +PR 1ZA / 1ZB / 1ZE / 1ZF; für Linkslenker	24.4153-1522.3	011048	ATE Ø 23,8 ohne Bremsflüssigkeitsbehälter
1.4 TSI	103	11/12→02/17		+PR 1ZA / 1ZB / 1ZE / 1ZF; für Linkslenker	03.4153-5403.3	010994	ATE Ø 23,8
1.4 TSI G-TEC	81	11/12→02/17			24.4123-1719.3	011017	TRW Ø 23,8 ohne Bremsflüssigkeitsbehälter
1.6 TDI	81	05/13→02/17					
1.6 TDI 4x4	77	11/12→05/15			24.4153-1522.3	011048	ATE Ø 23,8 ohne Bremsflüssigkeitsbehälter
1.8 TSI	132	11/12→10/20		01/14→; +PR 1ZA / 1ZB / 1ZE / 1ZF; für Linkslenker			
1.8 TSI 4x4	132	11/12→02/17					
2.0 TDI	105	11/12→02/17					
2.0 TDI 4x4	110	11/12→10/20					
2.0 TDI RS	135	05/13→10/20					
1.4 TSI	110	08/14→10/20		05/15→; für Linkslenker; +PR 1ZA / 1ZB / 1ZE / 1ZF	03.4153-5403.3	010994	ATE Ø 23,8
					24.4123-1719.3	011017	TRW Ø 23,8 ohne Bremsflüssigkeitsbehälter
				+PR 1ZA / 1ZB / 1ZE / 1ZF; für Linkslenker	24.4153-1522.3	011048	ATE Ø 23,8 ohne Bremsflüssigkeitsbehälter
2.0 TSI RS	162	11/12→02/17		05/13→; +PR 1ZA / 1ZB / 1ZE / 1ZF; für Linkslenker	03.4153-5403.3	010994	ATE Ø 23,8
					24.4123-1719.3	011017	TRW Ø 23,8 ohne Bremsflüssigkeitsbehälter
				01/14→; +PR 1ZA / 1ZB / 1ZE / 1ZF; für Linkslenker	24.4153-1522.3	011048	ATE Ø 23,8 ohne Bremsflüssigkeitsbehälter















	kw					! #		
SKODA - ROOMSTER (5J7) 03/06→05/15								
 Hauptbremszylinder								
1.2	47	05/06→01/07		07/06→; für Linkslenker; + ABS		24.2120-1734.3	010702	Ø 20,6
				07/06→; für Linkslenker; - ABS		24.2120-1736.3	010732	Ø 20,6
				07/06→; für Rechtslenker		24.2120-1768.3	011041	Ø 20,6 ohne Bremsflüssigkeitsbehälter
1.2	51	01/07→05/15		→ 12/10; für Linkslenker; + ABS		24.2120-1734.3	010702	Ø 20,6
1.2 LPG	51	03/09→05/15		→ 12/10; für Linkslenker; - ABS		24.2120-1736.3	010732	Ø 20,6
1.2 TDI	55	03/10→05/15						
1.2 TSI	63 - 77	03/10→05/15		für Rechtslenker; → 12/10		24.2120-1768.3	011041	Ø 20,6 ohne Bremsflüssigkeitsbehälter
1.4	63	09/06→05/15						
1.4 LPG	63	03/10→05/15						
1.6	77	09/06→05/15						
1.6 TDI	66 - 77	03/10→05/15						
1.4 TDI	51 - 59	07/06→03/10		für Linkslenker; + ABS		24.2120-1734.3	010702	Ø 20,6
1.6 LPG	77	06/06→07/10		für Linkslenker; - ABS		24.2120-1736.3	010732	Ø 20,6
1.9 TDI	77	09/06→03/10		für Rechtslenker		24.2120-1768.3	011041	Ø 20,6 ohne Bremsflüssigkeitsbehälter
 Bremskraftregler								
1.2	47	05/06→01/07		07/06→; - ABS		03.6584-0107.3	320110	ATE lastabhängig 8/4 4x
1.2	51	01/07→05/15		→ 04/15; - ABS		03.6584-0107.3	320110	ATE lastabhängig 8/4 4x
1.2 LPG	51	03/09→05/15						
1.2 TDI	55	03/10→05/15						
1.2 TSI	63 - 77	03/10→05/15						
1.4	63	09/06→05/15						
1.4 LPG	63	03/10→05/15						
1.6	77	09/06→05/15						
1.6 TDI	66 - 77	03/10→05/15						
1.4 TDI	51 - 59	07/06→03/10		- ABS		03.6584-0107.3	320110	ATE lastabhängig 8/4 4x
1.6 LPG	77	06/06→07/10						
1.9 TDI	77	09/06→03/10						
SKODA - ROOMSTER Praktik (5J) 03/07→05/15								
 Hauptbremszylinder								
1.2	51	03/07→05/15		für Linkslenker; → 12/10; + ABS		24.2120-1734.3	010702	Ø 20,6
1.2 TDI	55	03/10→05/15		für Linkslenker; → 12/10; - ABS		24.2120-1736.3	010732	Ø 20,6
1.2 TSI	63	03/10→05/15						
1.4	63	03/07→05/15		für Rechtslenker; → 12/10		24.2120-1768.3	011041	Ø 20,6 ohne Bremsflüssigkeitsbehälter
1.6 TDI	66	03/10→05/15						
1.4 TDI	51 - 59	03/07→03/10		für Linkslenker; + ABS		24.2120-1734.3	010702	Ø 20,6
				für Linkslenker; - ABS		24.2120-1736.3	010732	Ø 20,6
				für Rechtslenker		24.2120-1768.3	011041	Ø 20,6 ohne Bremsflüssigkeitsbehälter
 Bremskraftregler								
1.2	51	03/07→05/15		→ 04/15; - ABS		03.6584-0107.3	320110	ATE lastabhängig 8/4 4x
1.2 TDI	55	03/10→05/15						
1.2 TSI	63	03/10→05/15						
1.4	63	03/07→05/15						
1.6 TDI	66	03/10→05/15						
1.4 TDI	51 - 59	03/07→03/10		- ABS		03.6584-0107.3	320110	ATE lastabhängig 8/4 4x
SKODA - SUPERB I (3U4) 12/01→03/08								
 Hauptbremszylinder								
1.8 T	110	12/01→03/08		→ 02/08		03.2125-0373.3	010810	ATE Ø 25,4
2.0	85	12/01→03/08				24.2125-1720.3	010688	TRW Ø 25,4
1.9 TDI	74 - 77	08/02→05/07				03.2125-0373.3	010810	ATE Ø 25,4
2.0 TDI	91	02/06→03/08				24.2125-1720.3	010688	TRW Ø 25,4
2.5 TDI	114	12/01→08/03						
1.9 TDI	85 - 96	12/01→03/08		→ 12/07		03.2125-0373.3	010810	ATE Ø 25,4
2.0 TDI	103	10/05→03/08				24.2125-1720.3	010688	TRW Ø 25,4
2.5 TDI	120	06/03→03/08						
2.8 V6	140 - 142	12/01→03/08						













	kw			 	! #		
SKODA - SUPERB II (3T4) 03/08→05/15							
 Bremskraftverstärker							
1.4 TSI 1.8 TSI 2.0 TDI	92 118 125	07/08→05/15 03/08→05/15 07/08→05/15		08/08→ 02/15; für Linkslenker		03.7863-3332.4 300308	ATE Ø 10" pneumatisch
1.6 TDI 1.8 TSI 1.8 TSI 4x4 2.0 TDI 16V 2.0 TDI 16V 4x4 2.0 TFSI 3.6 FSI 4x4	77 112 112 - 118 103 103 147 191	09/10→05/15 03/09→05/15 11/08→05/15 01/09→05/15 11/10→05/15 05/10→05/15 11/08→05/15		→ 02/15; für Linkslenker		03.7863-3332.4 300308	ATE Ø 10" pneumatisch
1.9 TDI 2.0 TDI	77 103	03/08→11/10 03/08→05/10		08/08→; für Linkslenker		03.7863-3332.4 300308	ATE Ø 10" pneumatisch
2.0 TDI 4x4	125	09/08→05/15		10/08→ 02/15; für Linkslenker		03.7863-3332.4 300308	ATE Ø 10" pneumatisch
 Hauptbremszylinder							
1.4 TSI 1.8 TSI 2.0 TDI	92 118 125	07/08→05/15 03/08→05/15 07/08→05/15		08/08→ 02/15; für Linkslenker		03.2123-3449.3 010808	ATE Ø 23,8
				08/08→ 02/15; für Rechtslenker		24.4153-0202.3 011027	ATE Ø 23,8 ohne Bremsflüssigkeitsbehälter
1.6 TDI 1.8 TSI 1.8 TSI 4x4 2.0 TDI 16V 2.0 TDI 16V 4x4 2.0 TFSI 3.6 FSI 4x4	77 112 112 - 118 103 103 147 191	09/10→05/15 03/09→05/15 11/08→05/15 01/09→05/15 11/10→05/15 05/10→05/15 11/08→05/15		→ 02/15; für Linkslenker		03.2123-3449.3 010808	ATE Ø 23,8
				→ 02/15; für Rechtslenker		24.4153-0202.3 011027	ATE Ø 23,8 ohne Bremsflüssigkeitsbehälter
1.9 TDI 2.0 TDI	77 103	03/08→11/10 03/08→05/10		08/08→; für Linkslenker		03.2123-3449.3 010808	ATE Ø 23,8
				08/08→; für Rechtslenker		24.4153-0202.3 011027	ATE Ø 23,8 ohne Bremsflüssigkeitsbehälter
2.0 TDI 4x4	125	09/08→05/15		10/08→ 02/15; für Linkslenker		03.2123-3449.3 010808	ATE Ø 23,8
				10/08→ 02/15; für Rechtslenker		24.4153-0202.3 011027	ATE Ø 23,8 ohne Bremsflüssigkeitsbehälter
SKODA - SUPERB II Kombi (3T5) 10/09→05/15							
 Bremskraftverstärker							
1.4 TSI 1.8 TSI 1.8 TSI 4x4 2.0 TDI 2.0 TDI 16V 2.0 TDI 4x4 3.6 V6 4x4	92 112 - 118 112 - 118 125 103 125 191	10/09→05/15 10/09→05/15 10/09→05/15 10/09→05/15 10/09→05/15 10/09→05/15 10/09→05/15		11/09→ 02/15; für Linkslenker		03.7863-3332.4 300308	ATE Ø 10" pneumatisch
1.6 TDI 2.0 TDI 16V 4x4 2.0 TFSI	77 103 147	09/10→05/15 11/10→05/15 05/10→05/15		→ 02/15; für Linkslenker		03.7863-3332.4 300308	ATE Ø 10" pneumatisch
1.9 TDI 2.0 TDI	77 103	10/09→11/10 10/09→03/10		für Linkslenker		03.7863-3332.4 300308	ATE Ø 10" pneumatisch
				11/09→; für Linkslenker		03.7863-3332.4 300308	ATE Ø 10" pneumatisch
 Hauptbremszylinder							
1.4 TSI 1.8 TSI 1.8 TSI 4x4 2.0 TDI 2.0 TDI 16V 2.0 TDI 4x4 3.6 V6 4x4	92 112 - 118 112 - 118 125 103 125 191	10/09→05/15 10/09→05/15 10/09→05/15 10/09→05/15 10/09→05/15 10/09→05/15 10/09→05/15		11/09→ 02/15; für Linkslenker		03.2123-3449.3 010808	ATE Ø 23,8
				11/09→ 02/15; für Rechtslenker		24.4153-0202.3 011027	ATE Ø 23,8 ohne Bremsflüssigkeitsbehälter
1.6 TDI 2.0 TDI 16V 4x4 2.0 TFSI	77 103 147	09/10→05/15 11/10→05/15 05/10→05/15		→ 02/15; für Linkslenker		03.2123-3449.3 010808	ATE Ø 23,8
				→ 02/15; für Rechtslenker		24.4153-0202.3 011027	ATE Ø 23,8 ohne Bremsflüssigkeitsbehälter
1.9 TDI	77	10/09→11/10		für Linkslenker		03.2123-3449.3 010808	ATE Ø 23,8
				für Rechtslenker		24.4153-0202.3 011027	ATE Ø 23,8 ohne Bremsflüssigkeitsbehälter
2.0 TDI	103	10/09→03/10		11/09→; für Linkslenker		03.2123-3449.3 010808	ATE Ø 23,8
				11/09→; für Rechtslenker		24.4153-0202.3 011027	ATE Ø 23,8 ohne Bremsflüssigkeitsbehälter















	kw			 	! #		
SKODA - SUPERB III (3V3) 03/15→							
 Hauptbremszylinder							
1.4 TSI	92 - 110	03/15→		für Linkslenker		24.4123-1719.3 011017	TRW Ø 23,8 ohne Bremsflüssigkeitsbehälter
1.4 TSI 4x4	110	03/15→				24.4153-1522.3 011048	ATE Ø 23,8 ohne Bremsflüssigkeitsbehälter
1.5 TSI	110	02/17→					
1.6 TDI	88	03/15→					
1.8 TSI	132	03/15→					
2.0 TDI	110 - 147	03/15→					
2.0 TDI 4x4	110 - 147	03/15→					
2.0 TSI	162	03/15→					
2.0 TSI 4x4	200 - 206	03/15→					
2.0 TDI	90	07/20→		für Linkslenker		24.4153-1522.3 011048	ATE Ø 23,8 ohne Bremsflüssigkeitsbehälter
2.0 TSI	140	07/19→					
SKODA - SUPERB III Kombi (3V5) 03/15→							
 Hauptbremszylinder							
1.4 TSI	92 - 110	03/15→		für Linkslenker		24.4123-1719.3 011017	TRW Ø 23,8 ohne Bremsflüssigkeitsbehälter
1.4 TSI 4x4	110	03/15→				24.4153-1522.3 011048	ATE Ø 23,8 ohne Bremsflüssigkeitsbehälter
1.5 TSi	110	02/17→					
1.6 TDI	88	03/15→					
1.8 TSI	132	03/15→					
2.0 TDI	110 - 147	03/15→					
2.0 TDI 4x4	110 - 147	03/15→					
2.0 TSI	162	03/15→					
2.0 TSI 4x4	200 - 206	03/15→					
2.0 TDI	90	07/20→		für Linkslenker		24.4153-1522.3 011048	ATE Ø 23,8 ohne Bremsflüssigkeitsbehälter
2.0 TSI	140	07/19→					
SKODA - YETI (5L) 05/09→12/17							
 Bremskraftverstärker							
1.2 TSI	77 - 81	09/09→12/17		für Linkslenker; +PR 1AC / 1AS / 1AT / 1ZE / 1ZF		03.7863-3232.4 300307	ATE Ø 10" pneumatisch
1.4 TSI	90 - 92	06/10→12/17		+PR 1AT / 1ZA / 1ZE / 1LK; für Linkslenker		03.7863-3332.4 300308	ATE Ø 10" pneumatisch
1.4 TSI 4x4	110	05/15→12/17					
1.6	81	04/14→12/17					
1.6 TDI	77	11/10→05/15					
1.8 TSI 4x4	112 - 118	05/09→12/17					
2.0 TDI	81 - 110	11/09→12/17					
2.0 TDI 4x4	81 - 125	05/09→12/17					
 Hauptbremszylinder							
1.2 TSI	77 - 81	09/09→12/17		für Linkslenker; +PR 1ZE / 1ZF		03.2122-2129.3 010799	ATE Ø 22,2
1.4 TSI	90 - 92	06/10→12/17		für Linkslenker; +PR 1ZA		03.2123-3449.3 010808	ATE Ø 23,8
1.4 TSI 4x4	110	05/15→12/17		für Rechtslenker; +PR 1ZE / 1ZF		24.4152-0132.3 011025	ATE Ø 22,2 ohne Bremsflüssigkeitsbehälter
1.6	81	04/14→12/17					
1.6 TDI	77	11/10→05/15		für Rechtslenker; +PR 1ZA		24.4153-0202.3 011027	ATE Ø 23,8 ohne Bremsflüssigkeitsbehälter
1.8 TSI 4x4	112 - 118	05/09→12/17					
2.0 TDI	81 - 110	11/09→12/17					
2.0 TDI 4x4	81 - 125	05/09→12/17					
SMART - CITY-COUPÉ (450) 07/98→01/04							
 Hauptbremszylinder							
0.6	33 - 52	07/98→01/04		01/03→; für Linkslenker		24.2119-1711.3 010911	Ø 19 ohne Bremsflüssigkeitsbehälter
0.8 CDI	30	11/99→01/04		→ 12/02; für Linkslenker; zusätzlich benötigter Artikel (Artikel-Nummer): Q0014462V001000000		24.2119-1711.3 010911	Ø 19 ohne Bremsflüssigkeitsbehälter
0.7	37 - 55	01/03→01/04		für Linkslenker		24.2119-1711.3 010911	Ø 19 ohne Bremsflüssigkeitsbehälter



	kw					! #		
SMART - CROSSBLADE (450) 06/02→12/03								
 Hauptbremszylinder								
0.6	52	06/02→12/03		01/03→; für Linkslenker		24.2119-1711.3	010911	Ø 19 ohne Bremsflüssigkeitsbehälter
				→ 12/02; für Linkslenker; zusätzlich benötigter Artikel (Artikel-Nummer): Q0014462V001000000		24.2119-1711.3	010911	Ø 19 ohne Bremsflüssigkeitsbehälter
SMART - FORFOUR (454) 01/04→06/06								
 Hauptbremszylinder								
1.1	55	01/04→06/06		03/04→; für Linkslenker		24.2122-1770.3	010898	TRW Ø 22,2
1.3	70	01/04→06/06						
1.5	80	01/04→06/06						
1.1	47	02/05→06/06		für Linkslenker		24.2122-1770.3	010898	TRW Ø 22,2
1.5 BRABUS	130	05/05→06/06						
1.5 CDI	50 - 70	09/04→06/06						
1.5	90	01/04→06/06		11/04→; für Linkslenker		24.2122-1770.3	010898	TRW Ø 22,2
SMART - FORFOUR Schrägheck (453) 07/14→								
 Hauptbremszylinder								
0.9	66	11/14→		Schaltgetriebe		24.4150-1071.3	011046	ATE Ø 20,6 ohne Bremsflüssigkeitsbehälter
0.9 Brabus electric drive / EQ electric drive	80 41 60	07/16→ 05/17→ 05/17→				24.4150-1071.3	011046	ATE Ø 20,6 ohne Bremsflüssigkeitsbehälter
1.0	45	11/14→		01/15→; Schaltgetriebe		24.4150-1071.3	011046	ATE Ø 20,6 ohne Bremsflüssigkeitsbehälter
1.0	52	07/14→		11/14→; Schaltgetriebe		24.4150-1071.3	011046	ATE Ø 20,6 ohne Bremsflüssigkeitsbehälter
SMART - FORTWO Cabrio (450) 01/04→01/07								
 Hauptbremszylinder								
0.6	45	01/04→12/06		für Linkslenker		24.2119-1711.3	010911	Ø 19 ohne Bremsflüssigkeitsbehälter
0.6 Brabus	55	01/04→12/06						
0.7	45 - 55	01/04→01/07						
0.8 CDI	30	01/04→01/07						
SMART - FORTWO Cabrio (451) 01/07→								
 Hauptbremszylinder								
1.0	52	01/07→		K014181→; für Linkslenker		24.2123-1780.3	011081	Ø 23,8 ohne Bremsflüssigkeitsbehälter
SMART - FORTWO Cabriolet (453) 09/15→								
 Hauptbremszylinder								
0.9	66	09/15→				24.4150-1071.3	011046	ATE Ø 20,6 ohne Bremsflüssigkeitsbehälter
0.9 Brabus	80	07/16→						
1.0	52	09/15→						
electric drive / EQ electric drive	41 60	05/17→ 05/17→						
SMART - FORTWO Coupe (450) 01/04→02/07								
 Hauptbremszylinder								
0.6	45	01/04→02/07		→ J182805; für Linkslenker		24.2119-1711.3	010911	Ø 19 ohne Bremsflüssigkeitsbehälter
0.7	45	01/04→01/07						
0.8 CDI	30	01/04→01/07						
0.8 D	33	09/04→12/06						
0.7	34 - 55	01/04→02/07		für Linkslenker		24.2119-1711.3	010911	Ø 19 ohne Bremsflüssigkeitsbehälter
0.7	40	01/04→01/07		→ J182808; für Linkslenker		24.2119-1711.3	010911	Ø 19 ohne Bremsflüssigkeitsbehälter
SMART - FORTWO Coupe (451) 01/07→								
 Hauptbremszylinder								
1.0	45 - 52	01/07→		K014181→; für Linkslenker		24.2123-1780.3	011081	Ø 23,8 ohne Bremsflüssigkeitsbehälter
SMART - FORTWO Coupe (453) 07/14→								
 Hauptbremszylinder								
0.9	66	09/14→		11/14→		24.4150-1071.3	011046	ATE Ø 20,6 ohne Bremsflüssigkeitsbehälter
1.0	52	07/14→						
→								













	kw					! #		
SMART - FORTWO Coupe (453) 07/14→								
 Hauptbremszylinder								
0.9 Brabus electric drive / EQ	80	07/16→					24.4150-1071.3 011046	ATE Ø 20,6 ohne Bremsflüssigkeitsbehälter
1.0	41	05/17→						
1.0	60	05/17→						
1.0	45	11/14→		01/15→			24.4150-1071.3 011046	ATE Ø 20,6 ohne Bremsflüssigkeitsbehälter
SUBARU - JUSTY III (G3X) 09/03→								
 Hauptbremszylinder								
1.3 AWD	69	09/03→			→ 08/07		24.2120-1730.3 010678	Ø 20,6
1.5 AWD	73	09/03→						
1.3 CDTi	51	12/03→08/07		für Linkslenker			24.2120-1730.3 010678	Ø 20,6
SUZUKI - IGNIS II (MH) 08/03→								
 Hauptbremszylinder								
1.3	69	09/03→			→ 12/12; + ABS		24.2120-1730.3 010678	Ø 20,6
1.3 4x4	69	09/03→						
1.3 DDiS	51	09/03→						
1.5	73	09/03→						
1.5 4x4	73	09/03→						
SUZUKI - JIMNY Geländewagen geschlossen (SN) 07/98→								
 Hauptbremszylinder								
1.3	63	08/04→			- ABS		24.2122-1776.3 011001	Ø 22,2 ohne Bremsflüssigkeitsbehälter
1.3 16V	60	02/01→						
1.3 16V 4WD	60	02/01→						
1.3 16V 4x4	63	08/05→						
1.3 4WD	62	05/14→						
1.3 4x4	63	09/98→08/00						
1.5 DDiS 4WD	48	12/03→						
1.5 DDiS 4x4	63	08/05→						
SUZUKI - JIMNY Geländewagen offen (SN) 01/98→								
 Hauptbremszylinder								
1.3	63	08/04→			- ABS		24.2122-1776.3 011001	Ø 22,2 ohne Bremsflüssigkeitsbehälter
1.3 4WD	63	03/13→						
SUZUKI - SPLASH (EX) 01/08→								
 Hauptbremszylinder								
1.0	48 - 50	01/08→			für Linkslenker; - ESP		24.4122-1718.3 011019	BOS Ø 22,2 ohne Bremsflüssigkeitsbehälter
1.2	63	01/08→						
1.2 LPG	63	04/08→12/14			für Linkslenker; + ESP		24.4122-1719.3 011020	Ø 22,2 ohne Bremsflüssigkeitsbehälter
1.2 VVT	66 - 69	09/10→						
1.3 CDTi	55	01/08→						
SUZUKI - SWIFT III (MZ, EZ) 02/05→								
 Hauptbremszylinder								
1.2	66	04/08→12/10			für Linkslenker; - ESP		24.4122-1718.3 011019	BOS Ø 22,2 ohne Bremsflüssigkeitsbehälter
1.3	67	02/05→06/15						
1.3 4x4	66 - 68	02/05→			für Linkslenker; + ESP		24.4122-1719.3 011020	Ø 22,2 ohne Bremsflüssigkeitsbehälter
1.3 DDiS	51 - 55	08/05→						
1.5	75	02/05→						
1.5 4x4	74	02/05→						
1.6	92	05/06→						
1.3	68	02/05→			→ 09/10; für Linkslenker; - ESP		24.4122-1718.3 011019	BOS Ø 22,2 ohne Bremsflüssigkeitsbehälter
					→ 09/10; für Linkslenker; + ESP		24.4122-1719.3 011020	Ø 22,2 ohne Bremsflüssigkeitsbehälter
1.3 LPG	68	09/08→12/10			- ESP		24.4122-1718.3 011019	BOS Ø 22,2 ohne Bremsflüssigkeitsbehälter
					+ ESP		24.4122-1719.3 011020	Ø 22,2 ohne Bremsflüssigkeitsbehälter
SUZUKI - SX4 (EY, GY) 06/06→								
 Hauptbremszylinder								
1.5	73	06/06→07/10			- ESP; Fahrzeugproduktionsland Ungarn		24.4122-1712.3 010899	BOS Ø 22,2 ohne Bremsflüssigkeitsbehälter
1.5 VVT	82	07/10→						
1.5 VVTi	81	07/07→12/15						
1.6 LPG	79	06/06→12/12			+ ESP; Fahrzeugproduktionsland Ungarn		24.4122-1713.3 010900	BOS Ø 22,2 ohne Bremsflüssigkeitsbehälter
→								

	kw					! #		
SUZUKI - SX4 (EY, GY) 06/06→								
 Hauptbremszylinder								
1.6 VVT	79 - 88	06/06→		- ESP; Fahrzeugproduktionsland Ungarn		24.4122-1712.3	010899	BOS Ø 22,2 ohne Bremsflüssigkeitsbehälter
1.6 VVT 4x4	79 - 88	06/06→		+ ESP; Fahrzeugproduktionsland Ungarn		24.4122-1713.3	010900	BOS Ø 22,2 ohne Bremsflüssigkeitsbehälter
1.5 VVT 4x4	82	07/10→		- ESP		24.4122-1712.3	010899	BOS Ø 22,2 ohne Bremsflüssigkeitsbehälter
1.6 DDIS	66	04/07→						
1.9 DDiS	88	06/06→						
1.9 DDiS 4x4	88	06/06→		+ ESP		24.4122-1713.3	010900	BOS Ø 22,2 ohne Bremsflüssigkeitsbehälter
2.0 16V 4x4	112	01/10→						
2.0 DDiS	99	07/09→						
2.0 DDiS 4x4	99	07/09→						
SUZUKI - SX4 Stufenheck (GY, RW) 10/07→								
 Hauptbremszylinder								
1.6	79 - 88	10/07→		- ESP; Fahrzeugproduktionsland Ungarn		24.4122-1712.3	010899	BOS Ø 22,2 ohne Bremsflüssigkeitsbehälter
1.6 AWD	79	10/07→12/11		+ ESP; Fahrzeugproduktionsland Ungarn		24.4122-1713.3	010900	BOS Ø 22,2 ohne Bremsflüssigkeitsbehälter
SUZUKI - WAGON R Schrägheck 03/02→12/12								
 Hauptbremszylinder								
1.0	39 - 44	07/03→08/05				24.2120-1730.3	010678	Ø 20,6
1.2	59	06/04→08/05						
1.3	65	09/03→12/10		+ ABS		24.2120-1730.3	010678	Ø 20,6
SUZUKI - WAGON R+ Schrägheck (MM) 05/00→								
 Hauptbremszylinder								
1.0 XT Plus	74	08/00→07/01				24.2120-1730.3	010678	Ø 20,6
1.2	59	01/05→12/08						
1.3	56 - 69	05/00→08/06		+ ABS		24.2120-1730.3	010678	Ø 20,6
1.3 4WD	56	10/01→		→ 12/04; + ABS		24.2120-1730.3	010678	Ø 20,6
1.3 4WD	69	09/03→		→ 04/08; + ABS		24.2120-1730.3	010678	Ø 20,6
1.3 DDiS	51	09/03→						
TOYOTA - AVENSIS (_T25_) 03/03→11/08								
 Hauptbremszylinder								
1.6 VVT-i	81	04/03→11/08		+ ESP		24.2123-1771.3	010857	BOS Ø 23,8 ohne Bremsflüssigkeitsbehälter
1.8 VVT-i	95	03/03→10/08						
2.0 D-4D	85 - 93	04/03→11/08						
2.0 VVT-i	108	03/03→11/08						
2.0 VVTi	114	03/03→10/08						
2.2 D-4D	110	10/05→11/08						
2.2 D-CAT	130	07/05→11/08						
2.4 VVT-i	120 - 125	09/03→11/08						
TOYOTA - AVENSIS Kombi (_T25_) 04/03→11/08								
 Hauptbremszylinder								
1.6 VVT-i	81	04/03→11/08		+ ESP		24.2123-1771.3	010857	BOS Ø 23,8 ohne Bremsflüssigkeitsbehälter
2.0 D-4D	85 - 93	04/03→11/08						
2.0 VVT-i	108 - 114	04/03→11/08						
2.2 D-4D	110	10/05→11/08						
2.2 D-CAT	130	07/05→11/08						
2.4 VVT-i	120 - 125	09/03→11/08						
1.8 VVT-i	95	04/03→11/08		+ ESP; 02/04→		24.2123-1771.3	010857	BOS Ø 23,8 ohne Bremsflüssigkeitsbehälter
TOYOTA - AVENSIS Stufenheck (_T25_) 01/03→11/08								
 Hauptbremszylinder								
1.6 VVT-i	81	04/03→11/08		+ ESP		24.2123-1771.3	010857	BOS Ø 23,8 ohne Bremsflüssigkeitsbehälter
2.0 D-4D	85 - 93	04/03→11/08						
2.0 VVT-i	108	04/03→11/08						
2.0 VVTi	114	01/03→11/08						
2.2 D-4D	110	10/05→11/08						
2.2 D-CAT	130	07/05→11/08						
→								













	kw					! #		
TOYOTA - AVENSIS Stufenheck (_T25_) 01/03→11/08								
 Hauptbremszylinder								
2.4 VVT-i	120 - 125	09/03→11/08			+ ESP		24.2123-1771.3 010857	BOS Ø 23,8 ohne Bremsflüssigkeitsbehälter
1.8 VVT-i	95	04/03→11/08			+ ESP; 02/04→		24.2123-1771.3 010857	BOS Ø 23,8 ohne Bremsflüssigkeitsbehälter
TOYOTA - AYGO (_B1_) 02/05→05/14								
 Hauptbremszylinder								
1.0	50	07/05→05/14			- ESP; für Linkslenker		24.4120-1701.3 010846	BOS Ø 20,6
1.0 GPL	50	07/05→05/14			+ ESP; für Linkslenker		24.4120-1704.3 011042	Ø 20,6 ohne Bremsflüssigkeitsbehälter
1.4 D-4D	40	07/05→08/10			+ ESP; für Rechtslenker		24.4120-1705.3 011051	Ø 20,6 ohne Bremsflüssigkeitsbehälter
TOYOTA - AYGO (_B4_) 05/14→								
 Hauptbremszylinder								
1.0	51	05/14→			+ ESP		24.4120-1708.3 011084	Ø 20,6 ohne Bremsflüssigkeitsbehälter
					- ESP		24.4120-1712.3 011092	Ø 20,6 ohne Bremsflüssigkeitsbehälter
1.0 VVTi	53	03/18→			für Linkslenker; + ESP		24.4120-1708.3 011084	Ø 20,6 ohne Bremsflüssigkeitsbehälter
					für Linkslenker; - ESP		24.4120-1712.3 011092	Ø 20,6 ohne Bremsflüssigkeitsbehälter
1.2	60	05/14→			für Linkslenker		24.4120-1708.3 011084	Ø 20,6 ohne Bremsflüssigkeitsbehälter
TOYOTA - AYGO Kasten/Schrägheck (_B1_) 07/05→05/14								
 Hauptbremszylinder								
1.0 VVTi	50	07/05→05/14			- ESP; für Linkslenker		24.4120-1701.3 010846	BOS Ø 20,6
					+ ESP; für Linkslenker		24.4120-1704.3 011042	Ø 20,6 ohne Bremsflüssigkeitsbehälter
					+ ESP; für Rechtslenker		24.4120-1705.3 011051	Ø 20,6 ohne Bremsflüssigkeitsbehälter
TOYOTA - COROLLA (_E11_) 05/95→02/03								
 Hauptbremszylinder								
1.3	63	05/97→09/99			für Linkslenker		03.2122-1691.3 010918	ATE Ø 22,2
1.4	63	05/97→09/99						
1.4 16V	71	02/00→11/01			für Linkslenker; + ABS		03.2122-1691.3 010918	ATE Ø 22,2
1.6 16V	81	08/99→12/01					03.2122-1691.3 010918	ATE Ø 22,2
1.8	85 - 93	04/97→06/02						
1.9 D	51	02/00→11/01						
2.0 D-4D	66	09/00→11/01						
TOYOTA - COROLLA (_E12_) 01/01→04/08								
 Hauptbremszylinder								
1.4 D	66	07/04→02/07			→ 10/06; - ESP		24.2120-1749.3 010903	TRW Ø 20,6
					→ 10/06; + ESP		24.2120-1760.3 011018	Ø 20,6 ohne Bremsflüssigkeitsbehälter
1.4 VVT-i	71	11/01→02/07			06/04→ 10/06; - ESP		24.2120-1749.3 010903	TRW Ø 20,6
1.6 VVT-i	81	01/02→12/06			→ 05/04; - ESP		24.2120-1749.3 010903	TRW Ø 20,6
2.0 D-4D	85	05/03→02/07			06/04→ 10/06; + ESP		24.2120-1760.3 011018	Ø 20,6 ohne Bremsflüssigkeitsbehälter
					→ 05/04; + ESP		24.2120-1760.3 011018	Ø 20,6 ohne Bremsflüssigkeitsbehälter
1.8 4WD	100	01/01→02/07			→ 01/02		03.2122-1691.3 010918	ATE Ø 22,2
1.8 VVTi	100	01/01→12/07						
1.8 VVTL-i TS	160 - 165	02/05→02/07			→ 10/06; + ESP		24.2120-1760.3 011018	Ø 20,6 ohne Bremsflüssigkeitsbehälter
1.8 VVTL-i TS	141	11/01→02/07			→ 05/04; + ESP		24.2120-1760.3 011018	Ø 20,6 ohne Bremsflüssigkeitsbehälter
2.0 D-4D	66 - 81	01/02→12/06			→ 05/04; - ESP		24.2120-1749.3 010903	TRW Ø 20,6
					→ 05/04; + ESP		24.2120-1760.3 011018	Ø 20,6 ohne Bremsflüssigkeitsbehälter











	kw					! #		
TOYOTA - COROLLA Compact (_E10_) 05/92→12/99								
 Hauptbremszylinder								
1.6 i	78	09/94→11/99			→ 05/95; + ABS		24.2122-1779.3 011064	Ø 22,2 ohne Bremsflüssigkeitsbehälter
TOYOTA - COROLLA Compact (_E11_) 04/97→01/02								
 Hauptbremszylinder								
1.4	63	05/97→09/99			für Linkslenker		03.2122-1691.3 010918	ATE Ø 22,2
1.4	71	10/99→01/02			für Linkslenker; + ABS		03.2122-1691.3 010918	ATE Ø 22,2
1.6 1.9 D 2.0 D-4D	81 51 66	10/99→10/01 02/00→01/02 09/00→01/02					03.2122-1691.3 010918	ATE Ø 22,2
TOYOTA - COROLLA Kasten/Kombi (_E11_) 09/00→10/01								
 Hauptbremszylinder								
2.0 D4d	66	09/00→10/01					03.2122-1691.3 010918	ATE Ø 22,2
TOYOTA - COROLLA Kombi (_E11_) 04/97→10/01								
 Hauptbremszylinder								
1.4	63	04/97→02/00			05/97→ 09/99; für Linkslenker		03.2122-1691.3 010918	ATE Ø 22,2
1.4 16V	71	02/00→10/01			für Linkslenker; + ABS		03.2122-1691.3 010918	ATE Ø 22,2
1.6 16V 1.9 D 2.0 D-4D	81 51 66	02/00→10/01 02/00→10/01 09/00→10/01					03.2122-1691.3 010918	ATE Ø 22,2
1.8 4WD	81	04/97→10/01			05/97→		03.2122-1691.3 010918	ATE Ø 22,2
TOYOTA - COROLLA Kombi (_E12_) 03/01→12/08								
 Hauptbremszylinder								
1.3 1.4 VVT-i 1.5	65 71 81	09/02→08/07 01/02→02/07 03/01→09/06			06/04→; - ESP		24.2120-1749.3 010903	TRW Ø 20,6
					→ 05/04; - ESP		24.2120-1749.3 010903	TRW Ø 20,6
					06/04→; + ESP		24.2120-1760.3 011018	Ø 20,6 ohne Bremsflüssigkeitsbehälter
					→ 05/04; + ESP		24.2120-1760.3 011018	Ø 20,6 ohne Bremsflüssigkeitsbehälter
1.4 D4-D	66	06/04→10/07			→ 10/06; - ESP		24.2120-1749.3 010903	TRW Ø 20,6
					→ 10/06; + ESP		24.2120-1760.3 011018	Ø 20,6 ohne Bremsflüssigkeitsbehälter
1.6 VVT-i 2.0 D-4D	81 85	01/02→08/07 04/04→02/07			06/04→ 10/06; - ESP		24.2120-1749.3 010903	TRW Ø 20,6
					→ 05/04; - ESP		24.2120-1749.3 010903	TRW Ø 20,6
					06/04→ 10/06; + ESP		24.2120-1760.3 011018	Ø 20,6 ohne Bremsflüssigkeitsbehälter
					→ 05/04; + ESP		24.2120-1760.3 011018	Ø 20,6 ohne Bremsflüssigkeitsbehälter
1.8	100	12/01→12/07			→ 10/06; + ESP		24.2120-1760.3 011018	Ø 20,6 ohne Bremsflüssigkeitsbehälter
2.0 D-4D	66	01/02→02/07			→ 05/04; - ESP		24.2120-1749.3 010903	TRW Ø 20,6
					→ 05/04; + ESP		24.2120-1760.3 011018	Ø 20,6 ohne Bremsflüssigkeitsbehälter
TOYOTA - COROLLA Liftback (_E11_) 04/97→01/02								
 Hauptbremszylinder								
1.4	63	05/97→09/99			für Linkslenker		03.2122-1691.3 010918	ATE Ø 22,2
1.4	71	10/99→01/02			für Linkslenker; + ABS		03.2122-1691.3 010918	ATE Ø 22,2
1.6 1.9 D 2.0 D-4D	81 51 66	02/00→01/02 02/00→01/02 09/00→01/02					03.2122-1691.3 010918	ATE Ø 22,2
TOYOTA - COROLLA Stufenheck (_E12_) 08/00→12/08								
 Hauptbremszylinder								
1.3 1.4 D-4D 1.8	65 66 92 - 100	08/00→05/04 06/04→10/06 11/01→10/06			- ESP		24.2120-1749.3 010903	TRW Ø 20,6
					+ ESP		24.2120-1760.3 011018	Ø 20,6 ohne Bremsflüssigkeitsbehälter
1.4 VVT-i 1.5	71 80	10/01→10/06 11/01→07/07			06/04→; - ESP		24.2120-1749.3 010903	TRW Ø 20,6
					→ 05/04; - ESP		24.2120-1749.3 010903	TRW Ø 20,6
					06/04→; + ESP		24.2120-1760.3 011018	Ø 20,6 ohne Bremsflüssigkeitsbehälter
→								











	kw					! #					
TOYOTA - COROLLA Stufenheck (_E12_) 08/00→12/08											
 Hauptbremszylinder											
1.4 VVT-i 1.5	71 80	10/01→10/06 11/01→07/07		→ 05/04; + ESP			24.2120-1760.3 011018	Ø 20,6 ohne Bremsflüssigkeitsbehälter			
1.6 VVT-i	81	10/01→03/08		01/02→ 05/04; - ESP			24.2120-1749.3 010903	TRW Ø 20,6			
				06/04→ 10/06; - ESP			24.2120-1749.3 010903	TRW Ø 20,6			
				01/02→ 05/04; + ESP			24.2120-1760.3 011018	Ø 20,6 ohne Bremsflüssigkeitsbehälter			
				06/04→ 10/06; + ESP			24.2120-1760.3 011018	Ø 20,6 ohne Bremsflüssigkeitsbehälter			
1.8	96	03/01→07/05		01/02→ 05/04; - ESP			24.2120-1749.3 010903	TRW Ø 20,6			
				01/02→ 05/04; + ESP			24.2120-1760.3 011018	Ø 20,6 ohne Bremsflüssigkeitsbehälter			
2.0 D-4D	66	01/02→12/06		05/03→ 05/04; - ESP			24.2120-1749.3 010903	TRW Ø 20,6			
				→ 05/04; - ESP			24.2120-1749.3 010903	TRW Ø 20,6			
				05/03→ 05/04; + ESP			24.2120-1760.3 011018	Ø 20,6 ohne Bremsflüssigkeitsbehälter			
				→ 05/04; + ESP			24.2120-1760.3 011018	Ø 20,6 ohne Bremsflüssigkeitsbehälter			
2.0 D-4D	85	06/04→07/07		→ 10/06; - ESP			24.2120-1749.3 010903	TRW Ø 20,6			
				→ 10/06; + ESP			24.2120-1760.3 011018	Ø 20,6 ohne Bremsflüssigkeitsbehälter			
TOYOTA - COROLLA Verso (_E12_) 07/01→05/07											
 Hauptbremszylinder											
1.6 VVT-i 2.0 D-4D	81 66	08/01→05/04 01/02→05/04					24.2120-1749.3 010903	TRW Ø 20,6			
TOYOTA - COROLLA Verso (ZER_, ZZE12_, R1_) 03/04→10/09											
 Hauptbremszylinder											
1.3 VVTi 1.6 1.8	64 81 95	03/04→03/09 04/04→03/09 04/04→03/09		09/05→; + ESP			24.2123-1771.3 010857	BOS Ø 23,8 ohne Bremsflüssigkeitsbehälter			
			2.0 D-4D	85	04/04→03/09		05/04→ 08/05; + ESP			24.2123-1771.3 010857	BOS Ø 23,8 ohne Bremsflüssigkeitsbehälter
2.2 D-4D	100 - 130	10/05→03/09		+ ESP			24.2123-1771.3 010857	BOS Ø 23,8 ohne Bremsflüssigkeitsbehälter			
TOYOTA - RAV 4 II (_A2_) 05/00→11/05											
 Hauptbremszylinder											
1.8	92	08/00→11/05		02/01→ 07/03; Schaltgetriebe			24.2120-1757.3 010976	Ø 20,6 ohne Bremsflüssigkeitsbehälter			
				02/01→ 07/03; Automatikgetriebe			24.2120-1757.3 010976	Ø 20,6 ohne Bremsflüssigkeitsbehälter			
2.0 2.0 4WD	110 110	09/00→12/03 05/00→11/05		→ 07/03; Schaltgetriebe			24.2120-1757.3 010976	Ø 20,6 ohne Bremsflüssigkeitsbehälter			
				→ 07/03; Automatikgetriebe			24.2120-1757.3 010976	Ø 20,6 ohne Bremsflüssigkeitsbehälter			
2.0 D 4WD	85	05/01→11/05		09/01→ 07/03; Schaltgetriebe			24.2120-1757.3 010976	Ø 20,6 ohne Bremsflüssigkeitsbehälter			
				09/01→ 07/03; Automatikgetriebe			24.2120-1757.3 010976	Ø 20,6 ohne Bremsflüssigkeitsbehälter			
TOYOTA - YARIS / VIOS Stufenheck (_P9_) 08/05→12/13											
 Bremskraftverstärker											
1.5	80	01/06→12/13		für Linklenker; + ESP			03.7750-7132.4 300255	ATE Ø 9" pneumatisch			
				für Linklenker; - ESP			03.7853-3203.4 300241	ATE Ø 9" pneumatisch			
 Hauptbremszylinder											
1.5	80	01/06→12/13		- ESP			03.4152-0153.3 011006	ATE Ø 22,2 ohne Bremsflüssigkeitsbehälter			
				+ ESP			03.4152-0158.3 011007	ATE Ø 22,2 ohne Bremsflüssigkeitsbehälter			
TOYOTA - YARIS (_P1_) 01/99→12/05											
 Hauptbremszylinder											
1.0	48	03/03→09/05		04/03→ 08/05; Fahrzeugproduktionsland Frankreich			24.2120-1766.3 011000	Ø 20,6 ohne Bremsflüssigkeitsbehälter			
1.3	64	04/02→09/05		→ 08/05; Fahrzeugproduktionsland Frankreich			24.2120-1766.3 011000	Ø 20,6 ohne Bremsflüssigkeitsbehälter			
→											

	kw			 	! #		
TOYOTA - YARIS (P1) 01/99→12/05							
 Hauptbremszylinder							
1.4 D-4D	55	10/01→09/05		12/01→ 08/05; Fahrzeugproduktionsland Frankreich		24.2120-1766.3 011000	Ø 20,6 ohne Bremsflüssigkeitsbehälter
TOYOTA - YARIS (P9) 01/05→12/14							
 Bremskraftverstärker							
1.0 GPL 1.0 VVT-i	51 51 - 52	01/06→12/11 08/05→12/11		für Linkslenker; Fahrzeugproduktionsland Frankreich; + ESP		03.7750-7132.4 300255	ATE Ø 9" pneumatisch
				für Linkslenker; Fahrzeugproduktionsland Frankreich; - ESP		03.7853-3203.4 300241	ATE Ø 9" pneumatisch
1.33 VVT-i	73 - 74	11/08→12/11		für Linkslenker; + ESP		03.7750-7132.4 300255	ATE Ø 9" pneumatisch
1.3 4WD 1.3 VVT-i	64 63 - 64	08/07→11/10 08/05→12/12		für Linkslenker; - ESP		03.7853-3203.4 300241	ATE Ø 9" pneumatisch
1.5	80	11/05→12/14					
1.4 D-4D	66	08/05→12/12		für Linkslenker; + ESP		03.7750-7132.4 300255	ATE Ø 9" pneumatisch
				für Linkslenker		03.7853-3203.4 300241	ATE Ø 9" pneumatisch
 Hauptbremszylinder							
1.0 GPL 1.0 VVT-i	51 51 - 52	01/06→12/11 08/05→12/11		Fahrzeugproduktionsland Frankreich; - ESP		03.4152-0153.3 011006	ATE Ø 22,2 ohne Bremsflüssigkeitsbehälter
				Fahrzeugproduktionsland Frankreich; + ESP		03.4152-0158.3 011007	ATE Ø 22,2 ohne Bremsflüssigkeitsbehälter
1.33 VVT-i	73 - 74	11/08→12/11		- ESP		03.4152-0153.3 011006	ATE Ø 22,2 ohne Bremsflüssigkeitsbehälter
1.3 4WD 1.3 VVT-i	64 64	08/07→11/10 08/05→11/10		+ ESP		03.4152-0158.3 011007	ATE Ø 22,2 ohne Bremsflüssigkeitsbehälter
1.4 D-4D 1.5	66 80	08/05→12/12 11/05→12/14					
1.3 VVT-i	63	11/05→12/12		01/06→ 08/11; - ESP		03.4152-0153.3 011006	ATE Ø 22,2 ohne Bremsflüssigkeitsbehälter
				+ ESP		03.4152-0158.3 011007	ATE Ø 22,2 ohne Bremsflüssigkeitsbehälter
TOYOTA - YARIS (P13) 12/10→							
 Hauptbremszylinder							
1.0 1.3	51 63 - 73	12/10→ 12/10→		für Linkslenker; Fahrzeugproduktionsland Frankreich; + ESP		24.2122-1785.3 011114	Ø 22,2 ohne Bremsflüssigkeitsbehälter
1.3 4WD 1.5	70 80	12/10→ 12/10→		für Linkslenker; Fahrzeugproduktionsland Frankreich		24.2122-1786.3 011115	Ø 22,2 ohne Bremsflüssigkeitsbehälter
1.0 1.4 D 1.5	53 66 82	06/18→ 09/11→ 03/17→		für Linkslenker; + ESP		24.2122-1785.3 011114	Ø 22,2 ohne Bremsflüssigkeitsbehälter
				für Linkslenker		24.2122-1786.3 011115	Ø 22,2 ohne Bremsflüssigkeitsbehälter
1.8 GRMN	156	09/17→		für Linkslenker		24.2122-1785.3 011114	Ø 22,2 ohne Bremsflüssigkeitsbehälter
TOYOTA - YARIS Kasten/Schrägheck (P13) 10/12→							
 Hauptbremszylinder							
1.0 VVTi 1.3 VVTi	51 73	07/14→ 10/12→		für Linkslenker; Fahrzeugproduktionsland Frankreich; + ESP		24.2122-1785.3 011114	Ø 22,2 ohne Bremsflüssigkeitsbehälter
				für Linkslenker; Fahrzeugproduktionsland Frankreich		24.2122-1786.3 011115	Ø 22,2 ohne Bremsflüssigkeitsbehälter
1.0 VVTi 1.4 D4d	53 66	06/18→ 07/14→		für Linkslenker; + ESP		24.2122-1785.3 011114	Ø 22,2 ohne Bremsflüssigkeitsbehälter
				für Linkslenker		24.2122-1786.3 011115	Ø 22,2 ohne Bremsflüssigkeitsbehälter
1.5 VVTi	82	03/17→		+ ESP		24.2122-1785.3 011114	Ø 22,2 ohne Bremsflüssigkeitsbehälter
				für Linkslenker		24.2122-1786.3 011115	Ø 22,2 ohne Bremsflüssigkeitsbehälter
VAUXHALL - ADAM (M13) 10/12→04/19							
 Hauptbremszylinder							
1.0 1.4 S	85 110	07/14→11/18 11/14→01/19		für Linkslenker; Scheibenbremse		24.4123-1722.3 011071	Ø 23,8 ohne Bremsflüssigkeitsbehälter
1.2 1.4	51 64 - 74	10/12→04/19 10/12→02/19		01/13→; für Linkslenker; Scheibenbremse		24.4123-1722.3 011071	Ø 23,8 ohne Bremsflüssigkeitsbehälter



	kw					! #		
VAUXHALL - AGILA Mk I (A) (H00) 02/00→03/08								
 Hauptbremszylinder								
1.0 12V	43	09/00→08/05		+ ABS			24.2120-1730.3 010678	Ø 20,6
1.2 16V Twinport	59	07/04→11/06						
1.0 12V	44	02/00→11/06		09/00→; + ABS			24.2120-1730.3 010678	Ø 20,6
1.2 16V	55	09/00→03/08		+ ABS; → 07/07			24.2120-1730.3 010678	Ø 20,6
VAUXHALL - AGILA Mk II (B) (H08) 01/08→11/14								
 Hauptbremszylinder								
1.0 12V	48	01/08→11/14		für Linkslenker; - ESP			24.4122-1718.3 011019	BOS Ø 22,2 ohne Bremsflüssigkeitsbehälter
1.0 i	50	08/11→11/14						
1.2 i 16V	63 - 69	01/08→11/14		für Linkslenker; + ESP			24.4122-1719.3 011020	Ø 22,2 ohne Bremsflüssigkeitsbehälter
1.3 CDTI	55	01/08→11/14						
VAUXHALL - ASTRA Mk III (F) Cabriolet (T92) 09/91→03/01								
 Bremskraftregler								
1.6 i	55	01/96→03/01		→ R2500000			03.0101-0027.2 320022	ATE Satz 3/45 2x
VAUXHALL - ASTRA Mk IV (G) Cabriolet (T98) 03/01→10/05								
 Hauptbremszylinder								
1.6 16V	74 - 76	03/01→10/05		- ESP			24.2123-1734.3 010640	TRW Ø 23,8
1.8 16V	92	03/01→10/05		+ ESP			24.2123-1739.3 010661	Ø 23,8
2.0	147	09/02→10/05						
2.0 Turbo	141	03/02→10/05						
2.2 16V	108	03/01→10/05						
VAUXHALL - ASTRA Mk IV (G) CC (T98) 02/98→05/05								
 Hauptbremszylinder								
1.4 16V	66	02/98→05/05		04/98→; - ESP; für Fahrzeuge mit Scheibenbremse an der Hinterachse			24.2123-1734.3 010640	TRW Ø 23,8
1.6	55	02/98→09/00						
1.6 16V	74	02/98→05/05		22000001→; - ESP; für Fahrzeuge mit Trommelbremse an der Hinterachse			24.2123-1734.3 010640	TRW Ø 23,8
1.6 Dualfuel	55	02/98→12/00						
				04/98→; + ESP			24.2123-1739.3 010661	Ø 23,8
1.4 16V Dualfuel	66	09/99→06/03		- ESP; für Fahrzeuge mit Scheibenbremse an der Hinterachse			24.2123-1734.3 010640	TRW Ø 23,8
1.6	62	09/00→05/05						
1.6 Dualfuel	62 - 74	09/99→05/05		22000001→; - ESP; für Fahrzeuge mit Trommelbremse an der Hinterachse			24.2123-1734.3 010640	TRW Ø 23,8
1.7 DTI 16V	55	02/00→05/05		+ ESP			24.2123-1739.3 010661	Ø 23,8
1.6	76	12/02→05/05		- ESP			24.2123-1734.3 010640	TRW Ø 23,8
1.8 16V	92	09/00→05/05		+ ESP			24.2123-1739.3 010661	Ø 23,8
1.8 16V Dualfuel	87 - 92	07/02→05/05						
2.0	147	08/02→05/05						
2.0 DTI 16V	74	08/99→05/05						
2.0 SRI Turbo	141	11/01→05/05						
2.2 16V	108	03/01→05/05						
1.7 CDTI 16V	59	04/03→05/05		- ESP			24.2123-1734.3 010640	TRW Ø 23,8
1.7 TD	50	02/98→08/00		04/98→; - ESP; für Fahrzeuge mit Scheibenbremse an der Hinterachse			24.2123-1734.3 010640	TRW Ø 23,8
				04/98→; + ESP			24.2123-1739.3 010661	Ø 23,8
1.8 16V	85	02/98→09/00		04/98→; - ESP			24.2123-1734.3 010640	TRW Ø 23,8
2.0 16V	100	02/98→05/05						
2.0 DI	60	02/98→05/05		04/98→; + ESP			24.2123-1739.3 010661	Ø 23,8
VAUXHALL - ASTRA Mk IV (G) Coupe (T98) 03/00→08/05								
 Hauptbremszylinder								
1.6 16V	76	03/00→08/05		- ESP; für Fahrzeuge mit Scheibenbremse an der Hinterachse			24.2123-1734.3 010640	TRW Ø 23,8
				22000001→; - ESP; für Fahrzeuge mit Trommelbremse an der Hinterachse			24.2123-1734.3 010640	TRW Ø 23,8
				+ ESP			24.2123-1739.3 010661	Ø 23,8
1.8 16V	85 - 92	03/00→08/05		- ESP			24.2123-1734.3 010640	TRW Ø 23,8
1.8 16V Dualfuel	87 - 92	07/02→08/05		+ ESP			24.2123-1739.3 010661	Ø 23,8
2.0 16V Turbo	140	09/00→08/05						
2.2 16V	108	03/00→08/05		09/00→; - ESP			24.2123-1734.3 010640	TRW Ø 23,8
				09/00→; + ESP			24.2123-1739.3 010661	Ø 23,8

	kw				! #		
VAUXHALL - ASTRA Mk IV (G) Kombi (T98) 02/98→05/05							
 Hauptbremszylinder							
1.4 16V 1.6	66 55 - 62	02/98→05/05 03/98→04/04		04/98→; - ESP; für Fahrzeuge mit Scheibenbremse an der Hinterachse		24.2123-1734.3 010640	TRW Ø 23,8
1.6 16V 1.6 Dualfuel	74 63	03/98→04/04 03/98→04/04		22000001→; - ESP; für Fahrzeuge mit Trommelbremse an der Hinterachse		24.2123-1734.3 010640	TRW Ø 23,8
				04/98→; + ESP		24.2123-1739.3 010661	Ø 23,8
1.4 16V Dualfuel 1.6 1.6 Dualfuel	66 76 55 - 74	09/99→06/03 12/02→05/05 02/98→05/05		- ESP; für Fahrzeuge mit Scheibenbremse an der Hinterachse		24.2123-1734.3 010640	TRW Ø 23,8
				22000001→; - ESP; für Fahrzeuge mit Trommelbremse an der Hinterachse		24.2123-1734.3 010640	TRW Ø 23,8
1.7 DTI 16V	55	02/00→05/05		+ ESP		24.2123-1739.3 010661	Ø 23,8
1.7 CDTI 16V	59	04/03→05/05		- ESP		24.2123-1734.3 010640	TRW Ø 23,8
1.7 TD	50	02/98→08/00		04/98→; - ESP; für Fahrzeuge mit Scheibenbremse an der Hinterachse		24.2123-1734.3 010640	TRW Ø 23,8
				04/98→; + ESP		24.2123-1739.3 010661	Ø 23,8
1.8 16V 2.0 DI	85 60	02/98→08/00 03/98→04/04		04/98→; - ESP		24.2123-1734.3 010640	TRW Ø 23,8
				04/98→; + ESP		24.2123-1739.3 010661	Ø 23,8
1.8 16V 1.8 16V Dualfuel	92 87 - 92	09/00→05/05 07/02→05/05		- ESP		24.2123-1734.3 010640	TRW Ø 23,8
				+ ESP		24.2123-1739.3 010661	Ø 23,8
2.2 16V	108	03/01→05/05					
2.0 DTI 16V	74	03/98→04/04		08/99→; - ESP		24.2123-1734.3 010640	TRW Ø 23,8
				08/99→; + ESP		24.2123-1739.3 010661	Ø 23,8
 Bremskraftregler							
1.4 16V 1.6	66 55 - 62	02/98→05/05 03/98→04/04		04/98→; - ABS		03.6583-0073.3 320234	ATE lastabhängig 8/3 4x
1.6 16V 1.6 Dualfuel	74 63	03/98→04/04 03/98→04/04					
1.7 TD 1.8 16V	50 85	02/98→08/00 02/98→08/00					
1.4 16V Dualfuel 1.6 1.6 Dualfuel	66 76 55 - 74	09/99→06/03 12/02→05/05 02/98→08/04		- ABS		03.6583-0073.3 320234	ATE lastabhängig 8/3 4x
1.7 CDTI 16V 1.7 DTI 16V	59 55	04/03→05/05 02/00→05/05					
1.8 16V 1.8 16V Dualfuel	92 87 - 92	09/00→05/05 07/02→05/05					
VAUXHALL - ASTRA Mk IV (G) Stufenheck (T98) 02/98→05/05							
 Hauptbremszylinder							
1.4 16V 1.6	66 55 - 62	09/98→05/05 09/98→05/05		- ESP; für Fahrzeuge mit Scheibenbremse an der Hinterachse		24.2123-1734.3 010640	TRW Ø 23,8
1.6 16V 1.6 Dualfuel	74 55 - 74	09/98→05/05 02/98→05/05		22000001→; - ESP; für Fahrzeuge mit Trommelbremse an der Hinterachse		24.2123-1734.3 010640	TRW Ø 23,8
				+ ESP		24.2123-1739.3 010661	Ø 23,8
1.7 DTI 16V	55	02/00→05/05					
1.7 CDTI 16V	59	04/03→05/05		- ESP		24.2123-1734.3 010640	TRW Ø 23,8
1.7 TD	50	09/98→08/00		- ESP; für Fahrzeuge mit Scheibenbremse an der Hinterachse		24.2123-1734.3 010640	TRW Ø 23,8
				+ ESP		24.2123-1739.3 010661	Ø 23,8
1.8 16V	85 - 92	02/98→07/04		04/98→; - ESP		24.2123-1734.3 010640	TRW Ø 23,8
1.8 16V Dualfuel 2.0 DI	87 60	02/98→07/04 02/98→07/04		04/98→; + ESP		24.2123-1739.3 010661	Ø 23,8
1.8 16V Dualfuel 2.0 16V	92 100	07/02→12/03 09/98→05/05		- ESP		24.2123-1734.3 010640	TRW Ø 23,8
				+ ESP		24.2123-1739.3 010661	Ø 23,8
2.0 DTI 16V	74	02/98→07/04		08/99→; - ESP		24.2123-1734.3 010640	TRW Ø 23,8
				08/99→; + ESP		24.2123-1739.3 010661	Ø 23,8
VAUXHALL - ASTRA Mk V (H) (A04) 01/04→03/11							
 Bremskraftverstärker							
1.9 CDTI 1.9 CDTI 16V	88 - 110 88	01/04→05/09 01/04→05/09		09/04→; für Linkslenker		03.7863-7803.4 300237	ATE Ø 10" pneumatisch
 Hauptbremszylinder							
1.3 CDTI →	66	01/04→05/09		08/05→; → 68999999; für Linkslenker; + ESP		24.2125-1736.3 010904	TRW Ø 25,4

	kw					! #		
VAUXHALL - ASTRA Mk V (H) (A04) 01/04→03/11								
 Hauptbremszylinder								
1.3 CDTi	66	01/04→05/09		08/05→; → 68999999; für Rechtslenker		24.2125-1736.3	010904	TRW Ø 25,4
				08/05→; → 68999999; für Linkslenker; - ESP		24.2125-1737.3	010906	TRW Ø 25,4
				72000001→; für Rechtslenker		24.4125-1703.3	010907	TRW Ø 25,4
				72000001→; für Linkslenker; + ESP		24.4125-1703.3	010907	TRW Ø 25,4
				72000001→; für Linkslenker; - ESP		24.4125-1704.3	010908	TRW Ø 25,4
1.4 1.6 1.7 CDTi	66 77 59 - 74	01/04→05/09 01/04→05/09 01/04→05/09		für Rechtslenker; → 68999999		24.2125-1736.3	010904	TRW Ø 25,4
				für Linkslenker; → 68999999; + ESP		24.2125-1736.3	010904	TRW Ø 25,4
				für Linkslenker; → 68999999; - ESP		24.2125-1737.3	010906	TRW Ø 25,4
				72000001→; für Rechtslenker		24.4125-1703.3	010907	TRW Ø 25,4
				72000001→; für Linkslenker; + ESP		24.4125-1703.3	010907	TRW Ø 25,4
1.8 2.0 Turbo	125	01/04→05/09		72000001→; für Linkslenker; - ESP		24.4125-1704.3	010908	TRW Ø 25,4
				01/07→; → 68999999; für Rechtslenker		24.2125-1736.3	010904	TRW Ø 25,4
				01/07→; → 68999999; für Linkslenker; + ESP		24.2125-1736.3	010904	TRW Ø 25,4
				01/07→; → 68999999; für Rechtslenker		24.2125-1736.3	010904	TRW Ø 25,4
				01/07→; → 68999999; für Linkslenker; - ESP		24.2125-1737.3	010906	TRW Ø 25,4
1.6 1.6 Turbo	85 132	01/04→05/09 09/06→09/09		72000001→; für Linkslenker; - ESP		24.4125-1704.3	010908	TRW Ø 25,4
				72000001→; für Rechtslenker		24.4125-1703.3	010907	TRW Ø 25,4
				72000001→; für Linkslenker; + ESP		24.4125-1703.3	010907	TRW Ø 25,4
				72000001→; für Linkslenker; - ESP		24.4125-1704.3	010908	TRW Ø 25,4
				04/07→; → 68999999; für Rechtslenker		24.2125-1736.3	010904	TRW Ø 25,4
1.7 CDTi	81	01/04→03/11		04/07→; → 68999999; für Linkslenker; + ESP		24.2125-1736.3	010904	TRW Ø 25,4
				04/07→; → 68999999; für Rechtslenker		24.2125-1736.3	010904	TRW Ø 25,4
				04/07→; → 68999999; für Linkslenker; - ESP		24.2125-1737.3	010906	TRW Ø 25,4
				72000001→; für Rechtslenker		24.4125-1703.3	010907	TRW Ø 25,4
				72000001→; für Linkslenker; + ESP		24.4125-1703.3	010907	TRW Ø 25,4
1.8	103	01/04→05/09		72000001→; für Linkslenker; - ESP		24.4125-1704.3	010908	TRW Ø 25,4
				01/06→; → 68999999; für Rechtslenker		24.2125-1736.3	010904	TRW Ø 25,4
				01/06→; → 68999999; für Linkslenker; + ESP		24.2125-1736.3	010904	TRW Ø 25,4
				01/06→; → 68999999; für Rechtslenker		24.2125-1736.3	010904	TRW Ø 25,4
				01/06→; → 68999999; für Linkslenker; - ESP		24.2125-1737.3	010906	TRW Ø 25,4
1.9 CDTi 1.9 CDTi 16V	88 - 110 88	01/04→05/09 01/04→05/09		72000001→; für Linkslenker; - ESP		24.4125-1704.3	010908	TRW Ø 25,4
				09/04→		03.4155-0156.3	010862	ATE Ø 25,4
				09/04→; für Rechtslenker; → 68999999; + ESP		24.2125-1736.3	010904	TRW Ø 25,4
				09/04→; für Rechtslenker; → 68999999		24.2125-1736.3	010904	TRW Ø 25,4
				09/04→; für Linkslenker; → 68999999; - ESP		24.2125-1737.3	010906	TRW Ø 25,4
2.0 Turbo	147	01/04→05/09		72000001→; für Rechtslenker		24.4125-1703.3	010907	TRW Ø 25,4
				72000001→; für Linkslenker; + ESP		24.4125-1703.3	010907	TRW Ø 25,4
				72000001→; für Linkslenker; - ESP		24.4125-1704.3	010908	TRW Ø 25,4
				03/05→; → 68999999; für Rechtslenker		24.2125-1736.3	010904	TRW Ø 25,4
				03/05→; → 68999999; für Linkslenker; + ESP		24.2125-1736.3	010904	TRW Ø 25,4
2.0 Turbo	177	01/04→05/09		03/05→; → 68999999; für Rechtslenker		24.2125-1736.3	010904	TRW Ø 25,4
				03/05→; → 68999999; für Linkslenker; - ESP		24.2125-1737.3	010906	TRW Ø 25,4
				72000001→; für Rechtslenker		24.4125-1703.3	010907	TRW Ø 25,4
				72000001→; für Linkslenker; + ESP		24.4125-1703.3	010907	TRW Ø 25,4
				72000001→; für Linkslenker; - ESP		24.4125-1704.3	010908	TRW Ø 25,4
VAUXHALL - ASTRA Mk V (H) Kombi (A04) 08/04→10/12								
 Bremskraftverstärker								
1.9 CDTi 1.9 CDTi 16V	88 88	08/04→03/09 08/04→03/09		für Linkslenker		03.7863-7803.4	300237	ATE Ø 10" pneumatisch
				09/04→; für Linkslenker		03.7863-7803.4	300237	ATE Ø 10" pneumatisch
 Hauptbremszylinder								
1.3 CDTi	66	08/04→03/09		72000001→; für Linkslenker; + ESP		24.2125-1703.3	010483	Ø 25,4
				72000001→; für Linkslenker; - ESP		24.2125-1704.3	010446	TRW Ø 25,4
				08/05→; → 62999999; für Rechtslenker		24.2125-1736.3	010904	TRW Ø 25,4
→								

VAUXHALL - ASTRA Mk V (H) Kombi (A04) 08/04→10/12

 **Hauptbremszylinder**

1.3 CDTi	66	08/04→03/09	08/05→; → 68999999; für Linkslenker; + ESP	24.2125-1736.3	010904	TRW Ø 25,4
			08/05→; → 68999999; für Linkslenker; - ESP	24.2125-1737.3	010906	TRW Ø 25,4
			72000001→; für Rechtslenker	24.4125-1703.3	010907	TRW Ø 25,4
1.4	66	08/04→03/09	72000001→; für Linkslenker; + ESP	24.2125-1703.3	010483	Ø 25,4
1.6	77	08/04→03/09	72000001→; für Linkslenker; - ESP	24.2125-1704.3	010446	TRW Ø 25,4
1.7 CDTi	74	08/04→03/09	→ 62999999; für Rechtslenker	24.2125-1736.3	010904	TRW Ø 25,4
1.7 CDTi	59	08/04→05/09	→ 68999999; für Linkslenker; + ESP	24.2125-1736.3	010904	TRW Ø 25,4
1.8	92 - 103	10/04→10/10	→ 68999999; für Linkslenker; - ESP	24.2125-1737.3	010906	TRW Ø 25,4
2.0 Turbo	125	08/04→10/10	72000001→; für Rechtslenker	24.4125-1703.3	010907	TRW Ø 25,4
			72000001→; für Linkslenker; + ESP	24.2125-1703.3	010483	Ø 25,4
1.6	85 - 132	08/04→03/11	72000001→; für Linkslenker; - ESP	24.2125-1704.3	010446	TRW Ø 25,4
			01/07→; → 62999999; für Rechtslenker	24.2125-1736.3	010904	TRW Ø 25,4
			01/07→; → 68999999; für Linkslenker; + ESP	24.2125-1736.3	010904	TRW Ø 25,4
			01/07→; → 68999999; für Linkslenker; - ESP	24.2125-1737.3	010906	TRW Ø 25,4
			72000001→; für Rechtslenker	24.4125-1703.3	010907	TRW Ø 25,4
1.7 CDTi	81	08/04→10/12	72000001→; → 11/10; für Linkslenker; + ESP	24.2125-1703.3	010483	Ø 25,4
			72000001→; → 11/10; für Linkslenker; - ESP	24.2125-1704.3	010446	TRW Ø 25,4
			04/07→; → 62999999; für Rechtslenker	24.2125-1736.3	010904	TRW Ø 25,4
			04/07→; → 68999999; für Linkslenker; + ESP	24.2125-1736.3	010904	TRW Ø 25,4
			04/07→; → 68999999; für Linkslenker; - ESP	24.2125-1737.3	010906	TRW Ø 25,4
			72000001→; → 11/10; für Rechtslenker	24.4125-1703.3	010907	TRW Ø 25,4
1.9 CDTi	88	08/04→03/09		03.4155-0156.3	010862	ATE Ø 25,4
1.9 CDTi 16V	88	08/04→03/09				
1.9 CDTi	110	08/04→03/09	09/04→	03.4155-0156.3	010862	ATE Ø 25,4
2.0 Turbo	147	08/04→10/10	72000001→; für Linkslenker; + ESP	24.2125-1703.3	010483	Ø 25,4
			72000001→; für Linkslenker; - ESP	24.2125-1704.3	010446	TRW Ø 25,4
			09/04→; → 62999999; für Rechtslenker	24.2125-1736.3	010904	TRW Ø 25,4
			09/04→; → 68999999; für Linkslenker; + ESP	24.2125-1736.3	010904	TRW Ø 25,4
			09/04→; → 68999999; für Linkslenker; - ESP	24.2125-1737.3	010906	TRW Ø 25,4
			72000001→; für Rechtslenker	24.4125-1703.3	010907	TRW Ø 25,4

VAUXHALL - ASTRA Mk V (H) Sport Hatch (A04) 02/05→11/10











 **Bremskraftverstärker**













1.9 CDTi	74	08/05→11/10	09/05→; für Linkslenker	03.7863-7803.4	300237	ATE Ø 10" pneumatisch
1.9 CDTi	88 - 110	02/05→11/10	für Linkslenker	03.7863-7803.4	300237	ATE Ø 10" pneumatisch















 **Hauptbremszylinder**













1.3 CDTi	66	04/05→11/10	08/05→; → 68999999; für Linkslenker; + ESP	24.2125-1736.3	010904	TRW Ø 25,4
			08/05→; → 68999999; für Rechtslenker	24.2125-1736.3	010904	TRW Ø 25,4
			08/05→; → 68999999; für Linkslenker; - ESP	24.2125-1737.3	010906	TRW Ø 25,4
			72000001→; für Rechtslenker	24.4125-1703.3	010907	TRW Ø 25,4
			72000001→; für Linkslenker; + ESP	24.4125-1703.3	010907	TRW Ø 25,4
			72000001→; für Linkslenker; - ESP	24.4125-1704.3	010908	TRW Ø 25,4
1.4 i 16V	66	03/05→11/10	für Rechtslenker; → 68999999	24.2125-1736.3	010904	TRW Ø 25,4
1.6	77	02/05→11/10	für Linkslenker; → 68999999; + ESP	24.2125-1736.3	010904	TRW Ø 25,4
1.7 CDTi	74	02/05→11/10	für Linkslenker; → 68999999; - ESP	24.2125-1737.3	010906	TRW Ø 25,4
1.8	92	02/05→11/10	72000001→; für Rechtslenker	24.4125-1703.3	010907	TRW Ø 25,4
1.8 i 16V	103	03/07→11/10	72000001→; für Linkslenker; + ESP	24.4125-1703.3	010907	TRW Ø 25,4
2.0 Turbo	125	02/05→11/10	72000001→; für Linkslenker; - ESP	24.4125-1704.3	010908	TRW Ø 25,4
2.0 VXR	176	02/09→11/10	01/07→; → 68999999; für Linkslenker; + ESP	24.2125-1736.3	010904	TRW Ø 25,4
			01/07→; → 68999999; für Rechtslenker	24.2125-1736.3	010904	TRW Ø 25,4
			01/07→; → 68999999; für Linkslenker; - ESP	24.2125-1737.3	010906	TRW Ø 25,4















	kw				! #		
VAUXHALL - ASTRA Mk V (H) Sport Hatch (A04) 02/05→11/10							
 Hauptbremszylinder							
1.6 1.6 i 16V	132 85	10/06→11/10 12/06→11/10		72000001→; für Rechtslenker		24.4125-1703.3 010907	TRW Ø 25,4
				72000001→; für Linkslenker; + ESP		24.4125-1703.3 010907	TRW Ø 25,4
				72000001→; für Linkslenker; - ESP		24.4125-1704.3 010908	TRW Ø 25,4
1.7 CDTi	81	02/07→11/09		04/07→; → 68999999; für Linkslenker; + ESP		24.2125-1736.3 010904	TRW Ø 25,4
				04/07→; → 68999999; für Rechtslenker		24.2125-1736.3 010904	TRW Ø 25,4
				04/07→; → 68999999; für Linkslenker; - ESP		24.2125-1737.3 010906	TRW Ø 25,4
				72000001→; für Rechtslenker		24.4125-1703.3 010907	TRW Ø 25,4
				72000001→; für Linkslenker; + ESP		24.4125-1703.3 010907	TRW Ø 25,4
				72000001→; für Linkslenker; - ESP		24.4125-1704.3 010908	TRW Ø 25,4
1.9 CDTi	74	08/05→11/10		09/05→		03.4155-0156.3 010862	ATE Ø 25,4
1.9 CDTi	88 - 110	02/05→11/10				03.4155-0156.3 010862	ATE Ø 25,4
VAUXHALL - ASTRA Mk V (H) TwinTop (A04) 09/05→08/11							
 Bremskraftverstärker							
1.9 CDTi	110	01/06→11/10		03/06→; für Linkslenker		03.7863-7803.4 300237	ATE Ø 10" pneumatisch
 Hauptbremszylinder							
1.6 2.0 2.0 Turbo	77 125 147	09/05→11/10 02/06→11/10 01/06→11/10		03/06→; → 68999999; für Linkslenker; + ESP		24.2125-1736.3 010904	TRW Ø 25,4
				03/06→; → 68999999; für Rechtslenker		24.2125-1736.3 010904	TRW Ø 25,4
				03/06→; → 68999999; für Linkslenker; - ESP		24.2125-1737.3 010906	TRW Ø 25,4
				03/06→; für Rechtslenker		24.4125-1703.3 010907	TRW Ø 25,4
				72000001→; für Linkslenker; + ESP		24.4125-1703.3 010907	TRW Ø 25,4
				72000001→; für Linkslenker; - ESP		24.4125-1704.3 010908	TRW Ø 25,4
1.6 i 16V	85	10/06→08/11		12/06→; → 68999999; für Linkslenker; + ESP		24.2125-1736.3 010904	TRW Ø 25,4
				12/06→; → 68999999; für Rechtslenker		24.2125-1736.3 010904	TRW Ø 25,4
				12/06→; → 68999999; für Linkslenker; - ESP		24.2125-1737.3 010906	TRW Ø 25,4
				12/06→; für Rechtslenker		24.4125-1703.3 010907	TRW Ø 25,4
				72000001→; für Linkslenker; + ESP		24.4125-1703.3 010907	TRW Ø 25,4
				72000001→; für Linkslenker; - ESP		24.4125-1704.3 010908	TRW Ø 25,4
1.8	103	05/08→11/10		→ 68999999; für Rechtslenker		24.2125-1736.3 010904	TRW Ø 25,4
				→ 68999999; für Linkslenker; + ESP		24.2125-1736.3 010904	TRW Ø 25,4
				→ 68999999; für Linkslenker; - ESP		24.2125-1737.3 010906	TRW Ø 25,4
				für Rechtslenker		24.4125-1703.3 010907	TRW Ø 25,4
				72000001→; für Linkslenker; + ESP		24.4125-1703.3 010907	TRW Ø 25,4
				72000001→; für Linkslenker; - ESP		24.4125-1704.3 010908	TRW Ø 25,4
1.9 CDTi	110	01/06→11/10		03/06→; für Rechtslenker		03.4155-0156.3 010862	ATE Ø 25,4
				03/06→; für Linkslenker; + ESP		03.4155-0156.3 010862	ATE Ø 25,4
VAUXHALL - ASTRA Mk VI (J) (P10) 12/09→10/15							
 Bremskraftverstärker							
1.3 CDTI 1.4	70 64 - 74	12/09→10/15 12/09→10/15		für Linkslenker		03.7858-0732.4 300272	ATE Ø 9 / 8" pneumatisch
1.4 Turbo	88 - 103	12/09→10/15					
1.6 1.6 Turbo	85 132	12/09→10/15 12/09→10/15					
1.7 CDTi	81 - 96	12/09→10/15					
1.7 CDTI 2.0 BiTurbo CDTI 2.0 CDTi	74 143 118 - 121	10/10→10/15 12/12→10/15 12/09→10/15					
1.6 CDTi	81	11/13→10/15		02/14→; für Linkslenker		03.7858-0732.4 300272	ATE Ø 9 / 8" pneumatisch
1.6 CDTi	100	11/13→10/15		01/14→; für Linkslenker		03.7858-0732.4 300272	ATE Ø 9 / 8" pneumatisch
 Hauptbremszylinder							
1.3 CDTI 1.4	70 64 - 74	12/09→10/15 12/09→10/15		für Linkslenker		03.2125-0421.3 010934	ATE Ø 25,4
1.4 Turbo →	103	12/09→10/15		für Rechtslenker		24.4155-0201.3 011125	ATE Ø 25,4 ohne Bremsflüssigkeitsbehälter













	kw					! #		
VAUXHALL - ASTRA Mk VI (J) (P10) 12/09→10/15								
 Hauptbremszylinder								
1.6	85	12/09→10/15		für Linkslenker		03.2125-0421.3	010934	ATE Ø 25,4
1.6 Turbo	132	12/09→10/15		für Rechtslenker		24.4155-0201.3	011125	ATE Ø 25,4 ohne Bremsflüssigkeitsbehälter
1.7 CDTi	81 - 96	12/09→10/15						
1.7 CDTi	74	10/10→10/15						
2.0 BiTurbo CDTi	143	12/12→10/15						
2.0 CDTi	118 - 121	12/09→10/15						
1.4 Turbo	88	08/10→10/15		für Linkslenker		03.2125-0421.3	010934	ATE Ø 25,4
				11/10→; für Rechtslenker		24.4155-0201.3	011125	ATE Ø 25,4 ohne Bremsflüssigkeitsbehälter
1.6 CDTi	81	11/13→10/15		02/14→; für Linkslenker		03.2125-0421.3	010934	ATE Ø 25,4
				02/14→; für Rechtslenker		24.4155-0201.3	011125	ATE Ø 25,4 ohne Bremsflüssigkeitsbehälter
1.6 CDTi	100	11/13→10/15		01/14→; für Linkslenker		03.2125-0421.3	010934	ATE Ø 25,4
				01/14→; für Rechtslenker		24.4155-0201.3	011125	ATE Ø 25,4 ohne Bremsflüssigkeitsbehälter
VAUXHALL - ASTRA Mk VI (J) GTC (P10) 10/11→10/20								
 Bremskraftverstärker								
1.4	74 - 103	10/11→10/20		für Linkslenker		03.7858-0732.4	300272	ATE Ø 9 / 8" pneumatisch
1.6	132	10/11→10/20						
1.6 CDTi	81 - 100	07/14→10/20						
1.6 SIDI	125 - 147	09/13→10/20						
1.7 CDTi	81 - 96	10/11→10/20						
2.0 BiTurbo CDTi	143	12/12→10/20						
2.0 CDTi	121	10/11→10/20						
 Hauptbremszylinder								
1.4	74 - 103	10/11→10/20		für Linkslenker		03.2125-0421.3	010934	ATE Ø 25,4
1.6	132	10/11→10/20		für Rechtslenker		24.4155-0201.3	011125	ATE Ø 25,4 ohne Bremsflüssigkeitsbehälter
1.6 CDTi	81 - 100	07/14→10/20						
1.6 SIDI	125 - 147	09/13→10/20						
1.7 CDTi	81 - 96	10/11→10/20						
2.0 BiTurbo CDTi	143	12/12→10/20						
2.0 CDTi	121	10/11→10/20						
VAUXHALL - ASTRA Mk VI (J) Kombi (P10) 10/10→10/15								
 Bremskraftverstärker								
1.3 CDTi	70	10/10→10/15		11/10→; für Linkslenker		03.7858-0732.4	300272	ATE Ø 9 / 8" pneumatisch
1.4	64 - 74	10/10→10/15						
1.4 Turbo	103	10/10→10/15						
1.6	85	10/10→10/15						
1.6 Turbo	132	10/10→10/15						
1.7 CDTi	81 - 92	10/10→10/15						
2.0 CDTi	118	10/10→06/11						
1.6 CDTi	81	01/14→10/15		02/14→; für Linkslenker		03.7858-0732.4	300272	ATE Ø 9 / 8" pneumatisch
1.6 CDTi	100	01/14→10/15		für Linkslenker		03.7858-0732.4	300272	ATE Ø 9 / 8" pneumatisch
1.7 CDTi	96	06/11→10/15						
2.0 BiTurbo CDTi	143	12/12→10/15						
2.0 CDTi	121	08/11→10/15						
 Hauptbremszylinder								
1.3 CDTi	70	10/10→10/15		11/10→; für Linkslenker		03.2125-0421.3	010934	ATE Ø 25,4
1.4	64 - 74	10/10→10/15		11/10→; für Rechtslenker		24.4155-0201.3	011125	ATE Ø 25,4 ohne Bremsflüssigkeitsbehälter
1.4 Turbo	103	10/10→10/15						
1.6	85	10/10→10/15						
1.6 Turbo	132	10/10→10/15						
1.7 CDTi	81 - 92	10/10→10/15						
2.0 CDTi	118	10/10→06/11						
1.6 CDTi	81	01/14→10/15		02/14→; für Linkslenker		03.2125-0421.3	010934	ATE Ø 25,4
				02/14→; für Rechtslenker		24.4155-0201.3	011125	ATE Ø 25,4 ohne Bremsflüssigkeitsbehälter
1.6 CDTi	100	01/14→10/15		für Linkslenker		03.2125-0421.3	010934	ATE Ø 25,4
→								

	kw					! #		
VAUXHALL - ASTRA Mk VI (J) Kombi (P10) 10/10→10/15								
 Hauptbremszylinder								
1.7 CDTi 2.0 BiTurbo CDTi 2.0 CDTi	96 143 121	06/11→10/15 12/12→10/15 08/11→10/15		für Rechtslenker		24.4155-0201.3	011125	ATE Ø 25,4 ohne Bremsflüssigkeitsbehälter
VAUXHALL - ASTRAVAN Mk IV (G) Kasten/Kombi (T98) 01/93→08/06								
 Hauptbremszylinder								
1.4 16V 1.6 Dualfuel	66 55 - 74	09/00→05/05 02/98→08/05		- ESP; für Fahrzeuge mit Scheibenbremse an der Hinterachse		24.2123-1734.3	010640	TRW Ø 23,8
1.6 Dualfuel 16V 1.6 i	77 55 - 62	10/04→12/05 08/98→08/06		22000001→; - ESP; für Fahrzeuge mit Trommelbremse an der Hinterachse		24.2123-1734.3	010640	TRW Ø 23,8
1.7 DTI 16V 1.7 CDTi	55 59	08/98→08/06 07/03→08/06		+ ESP		24.2123-1739.3	010661	Ø 23,8
1.7 TD	50	08/98→08/06		- ESP; für Fahrzeuge mit Scheibenbremse an der Hinterachse		24.2123-1734.3	010640	TRW Ø 23,8
				+ ESP		24.2123-1739.3	010661	Ø 23,8
2.0 DI 2.0 DTI	60 74	08/98→08/06 04/04→08/06		- ESP		24.2123-1734.3	010640	TRW Ø 23,8
				+ ESP		24.2123-1739.3	010661	Ø 23,8
 Bremskraftregler								
1.4 16V 1.6 Dualfuel	66 55 - 74	09/00→05/05 02/98→08/05		- ABS		03.6583-0073.3	320234	ATE lastabhängig 8/3 4x
1.6 Dualfuel 16V 1.7 CDTi 1.7 TD	77 59 50	10/04→12/05 07/03→08/06 08/98→08/06						
VAUXHALL - ASTRAVAN Mk V (H) Kasten/Kombi (A04) 03/05→								
 Bremskraftverstärker								
1.9 CDTi	88 - 110	03/05→11/11		→ 11/10; für Linkslenker		03.7863-7803.4	300237	ATE Ø 10" pneumatisch
 Hauptbremszylinder								
1.3 CDTi 1.4 i 1.6 1.7 CDTi	66 66 76 74	08/05→ 03/05→ 03/05→ 03/05→11/11		72000001→; → 11/10; für Linkslenker; + ESP		24.2125-1703.3	010483	Ø 25,4
				72000001→; → 11/10; für Linkslenker; - ESP		24.2125-1704.3	010446	TRW Ø 25,4
				→ 62999999; für Rechtslenker		24.2125-1736.3	010904	TRW Ø 25,4
				→ 68999999; für Linkslenker; + ESP		24.2125-1736.3	010904	TRW Ø 25,4
				→ 68999999; für Linkslenker; - ESP		24.2125-1737.3	010906	TRW Ø 25,4
				72000001→; → 11/10; für Rechtslenker		24.4125-1703.3	010907	TRW Ø 25,4
1.7 CDTi	59	03/05→07/06		72000001→; für Linkslenker; + ESP		24.2125-1703.3	010483	Ø 25,4
				72000001→; für Linkslenker; - ESP		24.2125-1704.3	010446	TRW Ø 25,4
				→ 62999999; für Rechtslenker		24.2125-1736.3	010904	TRW Ø 25,4
				→ 68999999; für Linkslenker; + ESP		24.2125-1736.3	010904	TRW Ø 25,4
				→ 68999999; für Linkslenker; - ESP		24.2125-1737.3	010906	TRW Ø 25,4
				72000001→; für Rechtslenker		24.4125-1703.3	010907	TRW Ø 25,4
1.7 CDTi	81 - 92	06/11→		→ 62999999; für Rechtslenker		24.2125-1736.3	010904	TRW Ø 25,4
				→ 68999999; für Linkslenker; + ESP		24.2125-1736.3	010904	TRW Ø 25,4
				→ 68999999; für Linkslenker; - ESP		24.2125-1737.3	010906	TRW Ø 25,4
1.9 CDTi	88 - 110	03/05→11/11		→ 11/10		03.4155-0156.3	010862	ATE Ø 25,4
VAUXHALL - CASCADA Cabriolet (W13) 02/13→								
 Bremskraftverstärker								
1.4 1.6 2.0 CDTi	103 125 - 147 121 - 143	02/13→ 02/13→ 02/13→		für Linkslenker		03.7858-0732.4	300272	ATE Ø 9 / 8" pneumatisch
 Hauptbremszylinder								
1.4 1.6 2.0 CDTi	103 125 - 147 121 - 143	02/13→ 02/13→ 02/13→		für Linkslenker		03.2125-0421.3	010934	ATE Ø 25,4
				für Rechtslenker		24.4155-0201.3	011125	ATE Ø 25,4 ohne Bremsflüssigkeitsbehälter











	kw					! #		
VAUXHALL - COMBO Mk I (B) (S93) 07/94→10/01								
 Hauptbremszylinder								
1.4	44	07/94→10/01		→ 09/00; für Linkslenker; - ABS		24.2120-0702.3	010361	nicht für Delco Ø 20,6
1.4 16V	66	08/99→10/01		→ 09/00; für Linkslenker; + ABS		24.2120-1714.3	010455	Ø 20,6
1.7 D	44	07/94→10/01						
VAUXHALL - COMBO Mk II (C) Kasten/Großraumlimousine (F25) 09/01→02/12								
 Hauptbremszylinder								
1.3 CDTI 16V	51 - 55	09/04→02/12		→ 33999999		24.2122-1740.3	010711	DEL Ø 22,2
1.4 i 16V	66	01/04→11/11		43000001→; → 10/11; - ESP; Scheibenbremse		24.2123-1767.3	010844	BOS Ø 23,8
1.6	64	10/01→11/11						
1.7 DTI 16V	55	10/01→11/11						
1.4 16V	66	10/01→05/07		→ 33999999		24.2122-1740.3	010711	DEL Ø 22,2
				43000001→; - ESP; Scheibenbremse		24.2123-1767.3	010844	BOS Ø 23,8
1.6	62	09/01→10/04		10/01→; → 33999999		24.2122-1740.3	010711	DEL Ø 22,2
				43000001→; - ESP; Scheibenbremse		24.2123-1767.3	010844	BOS Ø 23,8
1.6 CNG 16V	69 - 71	04/05→02/12		→ 10/11; - ESP; Scheibenbremse		24.2123-1767.3	010844	BOS Ø 23,8
1.7 CDTI 16V	74	12/04→11/11						
1.7 DI 16V	48	09/01→11/11		10/01→; → 33999999		24.2122-1740.3	010711	DEL Ø 22,2
				43000001→; → 10/11; - ESP; Scheibenbremse		24.2123-1767.3	010844	BOS Ø 23,8
VAUXHALL - COMBO TOUR Mk II (C) (F25) 09/01→02/12								
 Hauptbremszylinder								
1.3 CDTI 16V	51	09/04→09/06		→ 33999999		24.2122-1740.3	010711	DEL Ø 22,2
1.4	66	10/04→09/10		43000001→; - ESP; Scheibenbremse		24.2123-1767.3	010844	BOS Ø 23,8
1.6	64	10/01→06/04						
1.3 CDTI 16V	55	07/06→02/12		→ 33999999		24.2122-1740.3	010711	DEL Ø 22,2
1.7 DTI 16V	55	10/01→02/12		43000001→; → 10/11; - ESP; Scheibenbremse		24.2123-1767.3	010844	BOS Ø 23,8
1.6 CNG	69	06/06→09/10		- ESP; Scheibenbremse		24.2123-1767.3	010844	BOS Ø 23,8
1.7 CDTI 16V	74	12/04→09/10						
1.6 CNG	71	04/05→02/12		→ 10/11; - ESP; Scheibenbremse		24.2123-1767.3	010844	BOS Ø 23,8
1.7 DI 16V	48	09/01→06/04		10/01→; → 33999999		24.2122-1740.3	010711	DEL Ø 22,2
				43000001→; - ESP; Scheibenbremse		24.2123-1767.3	010844	BOS Ø 23,8
VAUXHALL - CORSA Mk I (B) (S93) 12/92→09/00								
 Hauptbremszylinder								
1.0 i 12V	40	11/96→09/00		für Linkslenker; - ABS		24.2120-0702.3	010361	nicht für Delco Ø 20,6
1.4 i	44	03/93→09/00		für Linkslenker; + ABS		24.2120-1714.3	010455	Ø 20,6
1.4 i 16V	66	09/94→09/00						
1.4 i S	60	03/93→09/00						
1.6 i 16V	78	09/94→09/00						
1.7 D	44	02/96→09/00						
1.2 i	33	03/93→09/00		für Linkslenker; - ABS		24.2120-0702.3	010361	nicht für Delco Ø 20,6
				04/98→; für Linkslenker; - ABS		24.2120-0702.3	010361	nicht für Delco Ø 20,6
				für Linkslenker; + ABS		24.2120-1714.3	010455	Ø 20,6
				04/98→; für Linkslenker; + ABS		24.2120-1714.3	010455	Ø 20,6
1.2 i 16V	48	03/98→09/00		04/98→; für Linkslenker; - ABS		24.2120-0702.3	010361	nicht für Delco Ø 20,6
				04/98→; für Linkslenker; + ABS		24.2120-1714.3	010455	Ø 20,6
1.6 GSI 16V	80	03/93→09/00		09/93→; für Linkslenker; - ABS		24.2120-0702.3	010361	nicht für Delco Ø 20,6
				09/93→; für Linkslenker; + ABS		24.2120-1714.3	010455	Ø 20,6
VAUXHALL - CORSA Mk II (C) (X01) 08/00→04/07								
 Hauptbremszylinder								
1.0 12V	43 - 44	09/00→10/06		→ 36999999		24.2122-1740.3	010711	DEL Ø 22,2
1.2 16V	55	09/00→10/06						
1.2 16V Dualfuel	55	08/01→10/06						
1.2 Twinport	59	07/04→10/06						
1.3 CDTI 16V	51	10/03→04/07						
1.4 16V	66	09/00→10/06		43000001→; → 09/06; - ESP		24.2123-1767.3	010844	BOS Ø 23,8
1.4 Twinport	66	06/03→10/06						
1.7 CDTI 16V	74	08/00→09/06		06/03→; → 36999999		24.2122-1740.3	010711	DEL Ø 22,2
1.7 DI 16V	48	08/00→09/06		09/00→; → 36999999		24.2122-1740.3	010711	DEL Ø 22,2
1.7 DTI 16V	55	08/00→09/06						
1.8 16V	92	08/00→09/06		43000001→; - ESP		24.2123-1767.3	010844	BOS Ø 23,8













	kw					! #		
VAUXHALL - CORSA Mk III (D) (S07) 07/06→08/14								
 Hauptbremszylinder								
1.0 1.0 i 12V 1.2 1.2 LPG 1.3 CDTI 1.4 1.2 i 16V	44 48 51 - 59 59 - 63 70 74 63	08/06→08/14 01/10→08/14 08/06→08/14 09/09→08/14 07/10→08/14 01/10→08/14 12/09→08/14		für Linkslenker; + ESP für Linkslenker; - ESP für Linkslenker; - ESP 06/10→; für Linkslenker; + ESP 06/10→; für Linkslenker; - ESP			24.4122-1705.3 010852 24.4122-1709.3 010871 24.4122-1705.3 010852 24.4122-1709.3 010871	BOS Ø 22,2 ohne Bremsflüssigkeitsbehälter BOS Ø 22,2 ohne Bremsflüssigkeitsbehälter BOS Ø 22,2 ohne Bremsflüssigkeitsbehälter BOS Ø 22,2 ohne Bremsflüssigkeitsbehälter BOS Ø 22,2 ohne Bremsflüssigkeitsbehälter BOS Ø 23,8 ohne Bremsflüssigkeitsbehälter BOS Ø 23,8 ohne Bremsflüssigkeitsbehälter
1.3 CDTI 1.4 1.4 LPG 1.4 1.6 VXR 1.7 CDTI 1.6 SRi 1.7 CDTI	55 - 66 66 66 88 141 - 155 92 110 96	08/06→08/14 08/06→08/14 07/06→08/14 08/12→08/14 11/06→08/14 11/06→08/14 05/07→08/14 03/07→08/14		10/06→; für Linkslenker; + ESP 10/06→; für Linkslenker; - ESP für Linkslenker; - ESP 06/07→; für Linkslenker; - ESP 06/10→; für Linkslenker; - ESP			24.4122-1705.3 010852 24.4122-1709.3 010871 24.4123-1720.3 011022 24.4123-1720.3 011022 24.4123-1720.3 011022	BOS Ø 22,2 ohne Bremsflüssigkeitsbehälter BOS Ø 22,2 ohne Bremsflüssigkeitsbehälter BOS Ø 23,8 ohne Bremsflüssigkeitsbehälter BOS Ø 23,8 ohne Bremsflüssigkeitsbehälter BOS Ø 23,8 ohne Bremsflüssigkeitsbehälter
VAUXHALL - CORSA Mk IV (E) (X15) 08/14→								
 Hauptbremszylinder								
1.0 1.2 1.3 CDTi 1.4 1.6 VXR	66 - 85 51 55 - 70 55 - 74 151	08/14→ 08/14→ 08/14→ 08/14→ 04/15→		11/14→; für Linkslenker; Scheibenbremse für Linkslenker			24.4123-1722.3 011071 24.4123-1722.3 011071	Ø 23,8 ohne Bremsflüssigkeitsbehälter Ø 23,8 ohne Bremsflüssigkeitsbehälter
VAUXHALL - CORSAVAN Mk I (B) Kasten/Schrägheck (S93) 01/94→09/00								
 Hauptbremszylinder								
1.4 i 1.7 D	44 44	01/94→09/00 01/94→09/00		für Linkslenker; - ABS für Linkslenker; + ABS			24.2120-0702.3 010361 24.2120-1714.3 010455	nicht für Delco Ø 20,6 Ø 20,6
VAUXHALL - CORSAVAN Mk II (C) Kasten/Schrägheck (X01) 09/00→11/06								
 Hauptbremszylinder								
1.2 16V 1.2 16V Dualfuel 1.3 CDTI 16V 1.7 DI 16V 1.7 DTI 16V 1.4	55 - 59 55 - 59 52 48 55 66	09/00→11/06 08/01→06/06 04/04→06/06 09/00→06/06 09/00→06/06 11/03→06/06		→ 36999999 43000001→; - ESP			24.2122-1740.3 010711 24.2123-1767.3 010844	DEL Ø 22,2 BOS Ø 23,8
VAUXHALL - CORSAVAN Mk III (D) Kasten/Schrägheck (S07) 07/06→								
 Hauptbremszylinder								
1.2 1.3 CDTI 1.2 1.3 CDTI	51 70 59 55 - 66	01/10→ 07/06→ 07/09→ 07/06→		06/10→; für Linkslenker; + ESP 06/10→; für Linkslenker; - ESP für Linkslenker; + ESP für Linkslenker; - ESP 10/06→; für Linkslenker; + ESP 10/06→; für Linkslenker; - ESP			24.4122-1705.3 010852 24.4122-1709.3 010871 24.4122-1705.3 010852 24.4122-1709.3 010871 24.4122-1705.3 010852 24.4122-1709.3 010871	BOS Ø 22,2 ohne Bremsflüssigkeitsbehälter BOS Ø 22,2 ohne Bremsflüssigkeitsbehälter BOS Ø 22,2 ohne Bremsflüssigkeitsbehälter BOS Ø 22,2 ohne Bremsflüssigkeitsbehälter BOS Ø 22,2 ohne Bremsflüssigkeitsbehälter BOS Ø 22,2 ohne Bremsflüssigkeitsbehälter













	kw					! #		
VAUXHALL - CORSAVAN Mk IV (E) Kasten/Schrägheck (X15) 10/14→								
 Hauptbremszylinder								
1.2 1.3 CDTi	51 55 - 70	10/14→ 10/14→			11/14→; für Linkslenker; Scheiben- bremse		24.4123-1722.3 011071	Ø 23,8 ohne Bremsflüssigkeits- behälter
VAUXHALL - CROSSLAND X / CROSSLAND (P17) 03/17→								
 Hauptbremszylinder								
1.2 1.5 Turbo D)) 1.5 Turbo D 1.6 Turbo D	61 - 96 81 75 - 06/18→ 88 73 - 03/17→ 88	03/17→ 10/20→ 06/18→ 03/17→					24.4123-1704.3 010828	TRW Ø 23,8
VAUXHALL - INSIGNIA Mk I (A) Country Tourer (G09) 07/08→05/17								
 Bremskraftverstärker								
1.6 Turbo 2.0 Biturbo CDTI 4x4 2.0 CDTI 2.0 CDTI 4x4	125 143 120 - 125 125	07/13→05/17 09/13→05/17 07/13→05/17 11/14→05/17			für Linkslenker		03.7858-0732.4 300272	ATE Ø 9 / 8" pneumatisch
 Hauptbremszylinder								
1.6 Turbo 2.0 Biturbo CDTI 4x4 2.0 CDTI 2.0 CDTI 4x4 2.0 CDTI	125 143 125 125 120	07/13→05/17 09/13→05/17 11/14→05/17 11/14→05/17 07/13→05/17			für Linkslenker für Rechtslenker für Linkslenker 09/13→; für Rechtslenker für Rechtslenker		03.2125-0421.3 010934 24.4155-0201.3 011125 03.2125-0421.3 010934 24.4155-0201.3 011125 24.4155-0201.3 011125	ATE Ø 25,4 ATE Ø 25,4 ohne Bremsflüssig- keitsbehälter ATE Ø 25,4 ATE Ø 25,4 ohne Bremsflüssig- keitsbehälter ATE Ø 25,4 ohne Bremsflüssig- keitsbehälter
VAUXHALL - INSIGNIA Mk I (A) Schrägheck (G09) 07/08→05/17								
 Bremskraftverstärker								
1.4 1.4 LPG 1.6 1.6 CDTI 1.6 Turbo 1.8 2.0 Biturbo CDTI 2.0 Biturbo CDTI 4x4 2.0 CDTI 2.0 CDTI 4x4 2.0 Turbo 2.0 Turbo 4x4 2.0 CDTI 2.0 CDTI 4x4	103 103 85 100 125 - 132 103 143 143 81 - 140 125 - 140 162 - 184 162 88 118	04/11→05/17 07/12→05/17 07/08→07/12 07/15→05/17 01/09→05/17 07/08→05/17 03/12→05/17 03/12→05/17 07/08→05/17 140 05/09→05/17 140 07/08→05/17 184 07/08→05/17 03/12→03/16 07/08→05/17			06/11→; für Linkslenker für Linkslenker 03/13→; für Linkslenker 06/10→; für Linkslenker		03.7858-0732.4 300272 03.7858-0732.4 300272 03.7858-0732.4 300272 03.7858-0732.4 300272	ATE Ø 9 / 8" pneumatisch ATE Ø 9 / 8" pneumatisch ATE Ø 9 / 8" pneumatisch ATE Ø 9 / 8" pneumatisch
 Hauptbremszylinder								
1.4 1.4 LPG 1.6 1.6 CDTI 1.6 Turbo 1.8 2.0 Biturbo CDTI 2.0 Biturbo CDTI 4x4 2.0 CDTI 2.0 CDTI 4x4 2.0 Turbo 2.0 Turbo 4x4 2.8 V6 Turbo 4x4 2.8 VXR 2.0 CDTI →	103 103 85 100 125 - 132 103 143 143 81 - 140 125 - 140 162 162 191 239 88	04/11→05/17 07/12→05/17 07/08→07/12 07/15→05/17 01/09→05/17 07/08→05/17 03/12→05/17 03/12→05/17 07/08→05/17 140 05/09→05/17 140 07/08→05/17 07/08→05/17 07/08→05/17 07/09→05/17 03/12→03/16			06/11→; für Linkslenker 06/11→; für Rechtslenker für Linkslenker für Rechtslenker 03/13→; für Linkslenker		03.2125-0421.3 010934 24.4155-0201.3 011125 03.2125-0421.3 010934 24.4155-0201.3 011125 03.2125-0421.3 010934	ATE Ø 25,4 ATE Ø 25,4 ohne Bremsflüssig- keitsbehälter ATE Ø 25,4 ATE Ø 25,4 ohne Bremsflüssig- keitsbehälter ATE Ø 25,4















	kw					! #		
VAUXHALL - INSIGNIA Mk I (A) Schrägheck (G09) 07/08→05/17								
 Hauptbremszylinder								
2.0 CDTI	88	03/12→03/16		03/13→;	für Rechtslenker		24.4155-0201.3 011125	ATE Ø 25,4 ohne Bremsflüssigkeitsbehälter
2.0 CDTI 4x4	118	07/08→05/17		06/10→;	für Linkslenker		03.2125-0421.3 010934	ATE Ø 25,4
				06/10→;	für Rechtslenker		24.4155-0201.3 011125	ATE Ø 25,4 ohne Bremsflüssigkeitsbehälter
2.0 Turbo	184	07/11→05/17			für Linkslenker		03.2125-0421.3 010934	ATE Ø 25,4
					04/14→;	für Rechtslenker		24.4155-0201.3 011125
VAUXHALL - INSIGNIA Mk I (A) Sports Tourer (G09) 07/08→05/17								
 Bremskraftverstärker								
1.4	103	04/11→05/17		06/11→;	für Linkslenker		03.7858-0732.4 300272	ATE Ø 9 / 8" pneumatisch
1.4 LPG	103	07/12→05/17			für Linkslenker		03.7858-0732.4 300272	ATE Ø 9 / 8" pneumatisch
1.6	85	07/08→07/12						
1.6 CDTI	100	07/15→05/17						
1.6 Turbo	125 - 132	01/09→05/17						
1.8	103	07/08→05/17						
2.0 Biturbo CDTI	143	03/12→05/17						
2.0 Biturbo CDTI 4x4	143	03/12→05/17						
2.0 CDTI	81 - 140	07/08→05/17						
2.0 CDTI 4x4	125 - 140	05/09→05/17						
2.0 Turbo	162 - 184	07/08→05/17						
2.0 Turbo 4x4	162	07/08→05/17						
2.0 CDTI	88	03/12→03/16		03/13→;	für Linkslenker		03.7858-0732.4 300272	ATE Ø 9 / 8" pneumatisch
2.0 CDTI 4x4	118	07/08→05/17		06/10→;	für Linkslenker		03.7858-0732.4 300272	ATE Ø 9 / 8" pneumatisch
 Hauptbremszylinder								
1.4	103	04/11→05/17		06/11→;	für Linkslenker		03.2125-0421.3 010934	ATE Ø 25,4
				06/11→;	für Rechtslenker		24.4155-0201.3 011125	ATE Ø 25,4 ohne Bremsflüssigkeitsbehälter
1.4 LPG	103	07/12→05/17			für Linkslenker		03.2125-0421.3 010934	ATE Ø 25,4
1.6	85	07/08→07/12						
1.6 CDTI	100	07/15→05/17			für Rechtslenker		24.4155-0201.3 011125	ATE Ø 25,4 ohne Bremsflüssigkeitsbehälter
1.6 Turbo	125 - 132	01/09→05/17						
1.8	103	07/08→05/17						
2.0 Biturbo CDTI	143	03/12→05/17						
2.0 Biturbo CDTI 4x4	143	03/12→05/17						
2.0 CDTI	81 - 140	07/08→05/17						
2.0 CDTI 4x4	125 - 140	05/09→05/17						
2.0 Turbo	162	07/08→05/17						
2.0 Turbo 4x4	162	07/08→05/17						
2.8 V6 Turbo	191	08/08→05/17						
2.8 VXR	239	07/09→05/17						
2.0 CDTI	88	03/12→03/16		03/13→;	für Linkslenker		03.2125-0421.3 010934	ATE Ø 25,4
				03/13→;	für Rechtslenker		24.4155-0201.3 011125	ATE Ø 25,4 ohne Bremsflüssigkeitsbehälter
2.0 CDTI 4x4	118	07/08→05/17		06/10→;	für Linkslenker		03.2125-0421.3 010934	ATE Ø 25,4
				06/10→;	für Rechtslenker		24.4155-0201.3 011125	ATE Ø 25,4 ohne Bremsflüssigkeitsbehälter
2.0 Turbo	184	07/11→05/17			für Linkslenker		03.2125-0421.3 010934	ATE Ø 25,4
					04/14→;	für Rechtslenker		24.4155-0201.3 011125
VAUXHALL - INSIGNIA Mk I (A) Stufenheck (G09) 07/08→05/17								
 Bremskraftverstärker								
1.4	103	04/11→05/17		06/11→;	für Linkslenker		03.7858-0732.4 300272	ATE Ø 9 / 8" pneumatisch
1.4 LPG	103	07/12→05/17			für Linkslenker		03.7858-0732.4 300272	ATE Ø 9 / 8" pneumatisch
1.6	85	07/08→07/12						
1.6 CDTI	100	07/15→05/17						
1.6 Turbo	132	01/09→05/17						
1.8	103	07/08→05/17						
2.0 Biturbo CDTI	143	03/12→05/17						
2.0 Biturbo CDTI 4x4	143	03/12→05/17						
2.0 CDTI	96 - 140	07/08→05/17						
2.0 CDTI 4x4	125 - 140	05/09→05/17						
→								

	kw					! #		
VAUXHALL - INSIGNIA Mk I (A) Stufenheck (G09) 07/08→05/17								
 Bremskraftverstärker								
2.0 Turbo 2.0 Turbo 4x4	162 162 - 184	07/08→05/17 07/08→05/17		für Linkslenker		03.7858-0732.4	300272	ATE Ø 9 / 8" pneumatisch
2.0 CDTI 4x4	118	07/08→05/17		06/10→; für Linkslenker		03.7858-0732.4	300272	ATE Ø 9 / 8" pneumatisch
2.0 Turbo	184	09/11→05/17		04/14→; für Linkslenker		03.7858-0732.4	300272	ATE Ø 9 / 8" pneumatisch
 Hauptbremszylinder								
1.4	103	04/11→05/17		06/11→; für Linkslenker		03.2125-0421.3	010934	ATE Ø 25,4
				06/11→; für Rechtslenker		24.4155-0201.3	011125	ATE Ø 25,4 ohne Bremsflüssigkeitsbehälter
1.4 LPG 1.6 1.6 CDTi 1.6 Turbo 1.8 2.0 Biturbo CDTI 2.0 Biturbo CDTI 4x4 2.0 CDTI 2.0 CDTI 4x4 2.0 Turbo 2.0 Turbo 4x4 2.8 V6 Turbo 4x4 2.8 VXR	103 85 100 132 103 143 143 96 - 140 125 - 140 162 162 - 184 191 239	07/12→05/17 07/08→07/12 07/15→05/17 01/09→05/17 07/08→05/17 03/12→05/17 03/12→05/17 07/08→05/17 05/09→05/17 07/08→05/17 07/08→05/17 07/08→05/17 07/08→05/17 07/09→05/17		für Linkslenker für Rechtslenker		03.2125-0421.3	010934	ATE Ø 25,4
						24.4155-0201.3	011125	ATE Ø 25,4 ohne Bremsflüssigkeitsbehälter
2.0 CDTI 4x4	118	07/08→05/17		06/10→; für Linkslenker		03.2125-0421.3	010934	ATE Ø 25,4
				06/10→; für Rechtslenker		24.4155-0201.3	011125	ATE Ø 25,4 ohne Bremsflüssigkeitsbehälter
2.0 Turbo	184	09/11→05/17		04/14→; für Linkslenker		03.2125-0421.3	010934	ATE Ø 25,4
				04/14→; für Rechtslenker		24.4155-0201.3	011125	ATE Ø 25,4 ohne Bremsflüssigkeitsbehälter
VAUXHALL - MERIVA A (X03) 01/03→06/10								
 Hauptbremszylinder								
1.3 CDTI 1.6 Turbo 1.7 DTI 1.8 i 16V	51 132 55 92	04/05→06/10 05/06→06/10 06/03→06/10 05/03→06/10		54000001→ 74237191; - ESP → 44999999; - ESP 74237192→; → 05/10; + ESP		03.2120-2598.3 24.2123-1764.3 24.4123-1717.3	010116 010824 010985	ATE Ø 20,6 TRW Ø 23,8 TRW Ø 23,8 ohne Bremsflüssigkeitsbehälter
1.3 CDTI	55	01/03→10/09		54000001→ 74237191; - ESP 09/03→; → 44999999; - ESP 74237192→; + ESP		03.2120-2598.3 24.2123-1764.3 24.4123-1717.3	010116 010824 010985	ATE Ø 20,6 TRW Ø 23,8 TRW Ø 23,8 ohne Bremsflüssigkeitsbehälter
1.4 16V Twinport	66	01/03→06/10		54000001→ 74237191; - ESP 07/04→; → 44999999; - ESP 74237192→; → 05/10; + ESP		03.2120-2598.3 24.2123-1764.3 24.4123-1717.3	010116 010824 010985	ATE Ø 20,6 TRW Ø 23,8 TRW Ø 23,8 ohne Bremsflüssigkeitsbehälter
1.6 i	64	01/03→06/10		54000001→ 74237191; - ESP 05/03→; → 44999999; - ESP 74237192→; → 05/10; + ESP		03.2120-2598.3 24.2123-1764.3 24.4123-1717.3	010116 010824 010985	ATE Ø 20,6 TRW Ø 23,8 TRW Ø 23,8 ohne Bremsflüssigkeitsbehälter
1.6 i 16V	74	01/03→09/05		54000001→ 74237191; - ESP 05/03→; → 44999999; - ESP 74237192→; + ESP		03.2120-2598.3 24.2123-1764.3 24.4123-1717.3	010116 010824 010985	ATE Ø 20,6 TRW Ø 23,8 TRW Ø 23,8 ohne Bremsflüssigkeitsbehälter
1.6 i 16V Twinport	77	05/03→06/10		54000001→ 74237191; - ESP 01/06→; → 44999999; - ESP 74237192→; → 05/10; + ESP		03.2120-2598.3 24.2123-1764.3 24.4123-1717.3	010116 010824 010985	ATE Ø 20,6 TRW Ø 23,8 TRW Ø 23,8 ohne Bremsflüssigkeitsbehälter
1.7 CDTi	74	09/03→08/05		54000001→ 74237191; - ESP → 44999999; - ESP 74237192→; + ESP		03.2120-2598.3 24.2123-1764.3 24.4123-1717.3	010116 010824 010985	ATE Ø 20,6 TRW Ø 23,8 TRW Ø 23,8 ohne Bremsflüssigkeitsbehälter
VAUXHALL - MOKKA / MOKKA X (J13) 06/12→								
 Hauptbremszylinder								
1.4 1.4 4x4 →	103 103 - 112	04/13→ 06/12→		für Linkslenker		24.4123-1738.3	011124	Ø 23,8 ohne Bremsflüssigkeitsbehälter



	kw					! #		
VAUXHALL - MOKKA / MOKKA X (J13) 06/12→								
 Hauptbremszylinder								
1.6 1.6 CDTi 1.6 CDTi 1.6 CDTi 4x4 1.7 CDTi 1.7 CDTi 4x4	85 100 81 100 96 96	06/12→ 01/15→ 06/15→ 01/15→ 06/12→ 06/12→		für Linkslenker		24.4123-1738.3	011124	Ø 23,8 ohne Bremsflüssigkeitsbehälter
VAUXHALL - MOVANO Mk I (A) Chassis/Cab (X70) 10/98→12/10								
 Hauptbremszylinder								
2.2 DTI	66	09/00→05/10		→ 08/03; + ABS		24.2025-1706.3	010676	Ø 25,4
				→ 01/10; - ABS		24.2025-1708.3	010692	Ø 25,4
				09/03→; + ABS; → 08/06		24.2123-1759.3	010768	BOS Ø 23,8
2.5 CDTi	73	11/03→12/06		- ABS		24.2025-1708.3	010692	Ø 25,4
				+ ABS		24.2123-1759.3	010768	BOS Ø 23,8
2.5 D	59	10/98→08/02		→ 09/00; + ABS		24.2025-1706.3	010676	Ø 25,4
				→ 09/00; - ABS		24.2025-1708.3	010692	Ø 25,4
2.5 DTI	84	01/01→12/06		→ 08/03; + ABS		24.2025-1706.3	010676	Ø 25,4
				- ABS		24.2025-1708.3	010692	Ø 25,4
				09/03→; + ABS; → 08/06		24.2123-1759.3	010768	BOS Ø 23,8
2.8 DTI	84	10/98→10/01		+ ABS		24.2025-1706.3	010676	Ø 25,4
				- ABS		24.2025-1708.3	010692	Ø 25,4
3.0 DTi	100	10/03→05/10		→ 01/10; - ABS		24.2025-1708.3	010692	Ø 25,4
				→ 08/06; + ABS		24.2123-1759.3	010768	BOS Ø 23,8
VAUXHALL - MOVANO Mk I (A) Combi (X70) 10/98→05/10								
 Hauptbremszylinder								
1.9 DTI	60	10/01→05/10		→ 08/03; + ABS		24.2025-1706.3	010676	Ø 25,4
2.2 DTI	66	09/00→05/10		→ 01/10; - ABS		24.2025-1708.3	010692	Ø 25,4
				09/03→; + ABS; → 08/06		24.2123-1759.3	010768	BOS Ø 23,8
2.5 D	59	10/98→09/00		+ ABS		24.2025-1706.3	010676	Ø 25,4
2.8 DTI	84	10/98→10/01		- ABS		24.2025-1708.3	010692	Ø 25,4
2.5 DTI	84	10/01→08/09		→ 08/03; + ABS		24.2025-1706.3	010676	Ø 25,4
				- ABS		24.2025-1708.3	010692	Ø 25,4
				09/03→; + ABS; → 08/06		24.2123-1759.3	010768	BOS Ø 23,8
3.0 DTi	100	10/03→05/10		→ 01/10; - ABS		24.2025-1708.3	010692	Ø 25,4
				→ 08/06; + ABS		24.2123-1759.3	010768	BOS Ø 23,8
VAUXHALL - MOVANO Mk I (A) Van (X70) 10/98→12/10								
 Hauptbremszylinder								
1.9 DTI	60	10/01→05/10		→ 08/03; + ABS		24.2025-1706.3	010676	Ø 25,4
2.2 DTI	66	09/00→05/10		→ 01/10; - ABS		24.2025-1708.3	010692	Ø 25,4
2.5 DTI	84	10/01→05/10		09/03→; + ABS; → 08/06		24.2123-1759.3	010768	BOS Ø 23,8
2.5	73	11/03→12/06		- ABS		24.2025-1708.3	010692	Ø 25,4
				+ ABS		24.2123-1759.3	010768	BOS Ø 23,8
2.5 D	59	10/98→09/00		+ ABS		24.2025-1706.3	010676	Ø 25,4
2.8 TDI	84	10/98→10/01		- ABS		24.2025-1708.3	010692	Ø 25,4
3.0 DTi	100	10/03→05/10		→ 01/10; - ABS		24.2025-1708.3	010692	Ø 25,4
				→ 08/06; + ABS		24.2123-1759.3	010768	BOS Ø 23,8
VAUXHALL - OMEGA (B) Kombi (V94) 12/93→06/03								
 Hauptbremszylinder								
2.0 2.0 Dualfuel 2.5 TD	85 100 96	03/94→09/99 01/99→07/01 04/94→07/01		W1000001→; für Linkslenker; + ESP		24.2125-1740.3	010971	TRW Ø 25,4
2.0 16V	100	03/94→07/01		W1000001→; → 09/99; für Linkslenker; + ESP		24.2125-1740.3	010971	TRW Ø 25,4
2.0 DTI 16V	74	01/98→09/00		→ 08/00; für Linkslenker; + ESP		24.2125-1740.3	010971	TRW Ø 25,4
2.2 16V	106	02/94→06/03		10/99→; für Linkslenker; + ESP		24.2125-1740.3	010971	TRW Ø 25,4
2.2 DTI 16V	88	08/00→06/03		09/00→; für Linkslenker; + ESP		24.2125-1740.3	010971	TRW Ø 25,4
2.5 V6 3.0 V6	125 155	03/94→09/00 07/94→07/00		W1000001→; für Linkslenker; nicht für Sonderfahrzeuge; + ESP		24.2125-1740.3	010971	TRW Ø 25,4
2.6 V6	132	08/00→06/03		09/00→; für Linkslenker; nicht für Sonderfahrzeuge; + ESP		24.2125-1740.3	010971	TRW Ø 25,4
3.2 V6	160	02/01→06/03		für Linkslenker; nicht für Sonderfahrzeuge; + ESP		24.2125-1740.3	010971	TRW Ø 25,4

	kw				! #		
VAUXHALL - OMEGA (B) Stufenheck (V94) 12/93→07/03							
 Hauptbremszylinder							
2.0	85	03/94→09/99		W1000001→; für Linkslenker; + ESP		24.2125-1740.3 010971	TRW Ø 25,4
2.0 Dualfuel	100	05/98→07/01					
2.5 TD	96	04/94→07/01					
2.0 16V	100	03/94→07/01		W1000001→; → 09/99; für Linkslenker; + ESP		24.2125-1740.3 010971	TRW Ø 25,4
2.0 DTI 16V	74	01/98→09/00		→ 08/00; für Linkslenker; + ESP		24.2125-1740.3 010971	TRW Ø 25,4
2.2 16V	106	01/94→06/03		10/99→; für Linkslenker; + ESP		24.2125-1740.3 010971	TRW Ø 25,4
2.2 DTI 16V	88	08/00→07/03		09/00→; für Linkslenker; + ESP		24.2125-1740.3 010971	TRW Ø 25,4
2.5 V6	125	03/94→09/00		W1000001→; für Linkslenker; nicht für Sonderfahrzeuge; + ESP		24.2125-1740.3 010971	TRW Ø 25,4
3.0 V6	155	04/94→07/00					
2.6 V6	132	08/00→07/03		09/00→; für Linkslenker; nicht für Sonderfahrzeuge; + ESP		24.2125-1740.3 010971	TRW Ø 25,4
3.2 V6	160	02/01→07/03		für Linkslenker; nicht für Sonderfahrzeuge; + ESP		24.2125-1740.3 010971	TRW Ø 25,4
VAUXHALL - SIGNUM (Z03) 03/03→10/08							
 Hauptbremszylinder							
1.8	90	06/03→07/05		für Linkslenker; + ESP		24.2125-1732.3 010827	TRW Ø 25,4
1.9 CDTI	88	04/04→03/08					
1.9 CDTI 16V	110	04/04→03/08					
2.0 DTI	74	05/03→04/04					
2.2 DTI	92	05/03→05/08					
2.2 i	114	05/03→05/08					
3.0 CDTi	130	05/03→05/08					
3.2 V6	155	05/03→05/08					
1.8	103	08/05→05/08		09/05→; für Linkslenker; + ESP		24.2125-1732.3 010827	TRW Ø 25,4
2.0 i Turbo	129	03/03→10/08		05/03→; für Linkslenker; → 05/08; + ESP		24.2125-1732.3 010827	TRW Ø 25,4
3.0 V6 CDTI	135	07/05→06/08		09/05→ 05/08; für Linkslenker; + ESP		24.2125-1732.3 010827	TRW Ø 25,4
VAUXHALL - TIGRA Mk I (S93) 07/94→12/00							
 Hauptbremszylinder							
1.4 16V	66	07/94→12/00		für Linkslenker; - ABS		24.2120-0702.3 010361	nicht für Delco Ø 20,6
				für Linkslenker; + ABS		24.2120-1714.3 010455	Ø 20,6
1.6 16V	78	07/94→12/00		→ 08/98; für Linkslenker; - ABS		24.2120-0702.3 010361	nicht für Delco Ø 20,6
				→ 08/98; für Linkslenker; + ABS		24.2120-1714.3 010455	Ø 20,6
VAUXHALL - TIGRA TwinTop (X04) 06/04→08/09							
 Hauptbremszylinder							
1.3 CDTI	51	06/04→08/09		- ESP		24.2123-1767.3 010844	BOS Ø 23,8
1.4	66	06/04→08/09					
1.8	92	06/04→08/09					
VAUXHALL - VECTRA (B) CC (J96) 08/95→07/03							
 Bremskraftverstärker							
2.0 Dualfuel	100	08/98→01/01		für Linkslenker; → W1285446		03.7745-3003.4 300157	ATE Ø 8 / 7" pneumatisch
2.0 i 16V	100	10/95→01/01					
2.5 i GSi	143	03/98→07/00		für Linkslenker		03.7745-3003.4 300157	ATE Ø 8 / 7" pneumatisch
2.5 i V6	125	09/95→08/00					
2.6 i V6	125	09/00→07/03		→ 04/02; für Linkslenker		03.7745-3003.4 300157	ATE Ø 8 / 7" pneumatisch
 Hauptbremszylinder							
1.6 i	55	08/95→10/01		09/95→; → V1999999; für Linkslenker		24.2122-1724.3 010561	Ø 22,2
1.6 i 16V	74	08/95→10/01		09/95→; → V7999999; für Linkslenker		24.2122-1724.3 010561	Ø 22,2
				09/95→; → W1999999; für Rechtslenker		24.2122-1724.3 010561	Ø 22,2
				09/95→; → V5999999; für Linkslenker		24.2122-1724.3 010561	Ø 22,2
				09/95→; → W7999999; für Rechtslenker		24.2122-1724.3 010561	Ø 22,2
				09/95→; → W5999999; für Rechtslenker		24.2122-1724.3 010561	Ø 22,2
				W7000001→ W7999999; für Linkslenker		24.2123-1777.3 010943	Ø 23,8
				W5000001→ W5999999; für Linkslenker		24.2123-1777.3 010943	Ø 23,8
				W1000001→ W1999999; für Linkslenker		24.2123-1777.3 010943	Ø 23,8
1.8 Dualfuel	92	09/00→07/03		→ V1999999; für Linkslenker		24.2122-1724.3 010561	Ø 22,2
1.8 i 16V	85 - 92	09/95→07/03		→ V7999999; für Linkslenker		24.2122-1724.3 010561	Ø 22,2
2.0 DTI 16V	74	06/97→10/01		→ W1999999; für Rechtslenker		24.2122-1724.3 010561	Ø 22,2
				→ V5999999; für Linkslenker		24.2122-1724.3 010561	Ø 22,2
				→ W7999999; für Rechtslenker		24.2122-1724.3 010561	Ø 22,2
				→ W5999999; für Rechtslenker		24.2122-1724.3 010561	Ø 22,2
				W7000001→ W7999999; für Linkslenker		24.2123-1777.3 010943	Ø 23,8



VAUXHALL - VECTRA (B) CC (J96) 08/95→07/03

Hauptbremszylinder

1.8 Dualfuel 1.8 i 16V	92	09/00→07/03		W5000001→ W5999999; für Linkslenker	24.2123-1777.3	010943	Ø 23,8
	85 - 92	09/95→07/03		W1000001→ W1999999; für Linkslenker	24.2123-1777.3	010943	Ø 23,8
2.0 DTi 16V	74	06/97→10/01					
2.0 Di 16V	60	08/95→10/01		11/96→; → V7999999; für Linkslenker	24.2122-1724.3	010561	Ø 22,2
				11/96→; → W5999999; für Rechtslenker	24.2122-1724.3	010561	Ø 22,2
				11/96→; → V1999999; für Linkslenker	24.2122-1724.3	010561	Ø 22,2
				11/96→; → W7999999; für Rechtslenker	24.2122-1724.3	010561	Ø 22,2
				11/96→; → W1999999; für Rechtslenker	24.2122-1724.3	010561	Ø 22,2
				11/96→; → V5999999; für Linkslenker	24.2122-1724.3	010561	Ø 22,2
				W7000001→ W7999999; für Linkslenker	24.2123-1777.3	010943	Ø 23,8
				W5000001→ W5999999; für Linkslenker	24.2123-1777.3	010943	Ø 23,8
				W1000001→ W1999999; für Linkslenker	24.2123-1777.3	010943	Ø 23,8
2.0 Dualfuel	100	08/98→01/01		→ W1285446; für Linkslenker	03.2123-1622.3	010470	Ø 23,8
2.0 i 16V	100	10/95→01/01					
2.5 i GSi	143	03/98→07/00		→ W5276825; für Linkslenker	03.2123-1622.3	010470	Ø 23,8
2.5 i V6	125	09/95→08/00		→ W7154258; für Linkslenker	03.2123-1622.3	010470	Ø 23,8

VAUXHALL - VECTRA (B) Kombi (J96) 08/95→03/02

Bremskraftverstärker

2.0 Dualfuel	100	10/98→01/01		für Linkslenker; → W1285446	03.7745-3003.4	300157	ATE Ø 8 / 7" pneumatisch
2.0 i 16V	100	10/95→01/01					
2.5 i GSi	143	05/98→09/99		für Linkslenker	03.7745-3003.4	300157	ATE Ø 8 / 7" pneumatisch
2.5 i V6	125	11/96→08/00					
2.6 i V6	125	09/00→03/02					









Hauptbremszylinder

1.8 Dualfuel 1.8 i 16V	92 - 92	09/00→03/02		→ V1999999; für Linkslenker	24.2122-1724.3	010561	Ø 22,2
				→ V7999999; für Linkslenker	24.2122-1724.3	010561	Ø 22,2
				→ W1999999; für Rechtslenker	24.2122-1724.3	010561	Ø 22,2
				→ V5999999; für Linkslenker	24.2122-1724.3	010561	Ø 22,2
				→ W7999999; für Rechtslenker	24.2122-1724.3	010561	Ø 22,2
				→ W5999999; für Rechtslenker	24.2122-1724.3	010561	Ø 22,2
				W7000001→ W7999999; für Linkslenker	24.2123-1777.3	010943	Ø 23,8
				W5000001→ W5999999; für Linkslenker	24.2123-1777.3	010943	Ø 23,8
2.0 DI 16V	60	08/95→10/01		11/96→; → V1999999; für Linkslenker	24.2122-1724.3	010561	Ø 22,2
				11/96→; → V7999999; für Linkslenker	24.2122-1724.3	010561	Ø 22,2
				11/96→; → W1999999; für Rechtslenker	24.2122-1724.3	010561	Ø 22,2
				11/96→; → V5999999; für Linkslenker	24.2122-1724.3	010561	Ø 22,2
				11/96→; → W7999999; für Rechtslenker	24.2122-1724.3	010561	Ø 22,2
				11/96→; → W5999999; für Rechtslenker	24.2122-1724.3	010561	Ø 22,2
				W7000001→ W7999999; für Linkslenker	24.2123-1777.3	010943	Ø 23,8
				W5000001→ W5999999; für Linkslenker	24.2123-1777.3	010943	Ø 23,8
				W1000001→ W1999999; für Linkslenker	24.2123-1777.3	010943	Ø 23,8
2.0 DTi 16V	74	08/95→10/01		06/97→; → W5999999; für Rechtslenker	24.2122-1724.3	010561	Ø 22,2
				06/97→; → V5999999; für Linkslenker	24.2122-1724.3	010561	Ø 22,2
				06/97→; → W1999999; für Rechtslenker	24.2122-1724.3	010561	Ø 22,2
				06/97→; → W7999999; für Rechtslenker	24.2122-1724.3	010561	Ø 22,2
				06/97→; → V1999999; für Linkslenker	24.2122-1724.3	010561	Ø 22,2
				06/97→; → V7999999; für Linkslenker	24.2122-1724.3	010561	Ø 22,2
				W7000001→ W7999999; für Linkslenker	24.2123-1777.3	010943	Ø 23,8
				W5000001→ W5999999; für Linkslenker	24.2123-1777.3	010943	Ø 23,8
				W1000001→ W1999999; für Linkslenker	24.2123-1777.3	010943	Ø 23,8
2.0 Dualfuel	100	10/98→01/01		→ W1285446; für Linkslenker	03.2123-1622.3	010470	Ø 23,8
2.0 i 16V	100	10/95→01/01					
2.5 i GSi	143	05/98→09/99		→ W5276825; für Linkslenker	03.2123-1622.3	010470	Ø 23,8
2.5 i V6	125	11/96→08/00		→ W7154258; für Linkslenker	03.2123-1622.3	010470	Ø 23,8













VAUXHALL - VECTRA (B) Stufenheck (J96) 08/95→03/02













Bremskraftverstärker

2.0 Dualfuel	100	05/98→01/01		für Linkslenker; → W1285446	03.7745-3003.4	300157	ATE Ø 8 / 7" pneumatisch
2.0 i 16V	100	10/95→01/01					
2.5 i GSi	143	03/98→07/00		für Linkslenker	03.7745-3003.4	300157	ATE Ø 8 / 7" pneumatisch
2.5 i V6	125	09/95→08/00					
2.6 i V6	125	09/00→03/02					











	kw				! #		
VAUXHALL - VECTRA (B) Stufenheck (J96) 08/95→03/02							
 Hauptbremszylinder							
1.6 i 1.6 i 16V	55 74	08/95→10/01 08/95→10/01		09/95→; → W5999999; für Rechtslenker	24.2122-1724.3 010561	Ø 22,2	
				09/95→; → V7999999; für Linkslenker	24.2122-1724.3 010561	Ø 22,2	
				09/95→; → V5999999; für Linkslenker	24.2122-1724.3 010561	Ø 22,2	
				09/95→; → V1999999; für Linkslenker	24.2122-1724.3 010561	Ø 22,2	
				09/95→; → W7999999; für Rechtslenker	24.2122-1724.3 010561	Ø 22,2	
				09/95→; → W1999999; für Rechtslenker	24.2122-1724.3 010561	Ø 22,2	
				W7000001→ W7999999; für Linkslenker	24.2123-1777.3 010943	Ø 23,8	
				W5000001→ W5999999; für Linkslenker	24.2123-1777.3 010943	Ø 23,8	
				W1000001→ W1999999; für Linkslenker	24.2123-1777.3 010943	Ø 23,8	
1.8 Dualfuel 1.8 i 16V	92 85 - 92	09/00→03/02 10/95→03/02		→ V1999999; für Linkslenker	24.2122-1724.3 010561	Ø 22,2	
				→ V7999999; für Linkslenker	24.2122-1724.3 010561	Ø 22,2	
				→ W1999999; für Rechtslenker	24.2122-1724.3 010561	Ø 22,2	
				→ V5999999; für Linkslenker	24.2122-1724.3 010561	Ø 22,2	
				→ W7999999; für Rechtslenker	24.2122-1724.3 010561	Ø 22,2	
				→ W5999999; für Rechtslenker	24.2122-1724.3 010561	Ø 22,2	
				W7000001→ W7999999; für Linkslenker	24.2123-1777.3 010943	Ø 23,8	
				W5000001→ W5999999; für Linkslenker	24.2123-1777.3 010943	Ø 23,8	
				W1000001→ W1999999; für Linkslenker	24.2123-1777.3 010943	Ø 23,8	
2.0 DI 16V	60	08/95→10/01		11/96→; → W7999999; für Rechtslenker	24.2122-1724.3 010561	Ø 22,2	
				11/96→; → W5999999; für Rechtslenker	24.2122-1724.3 010561	Ø 22,2	
				11/96→; → V7999999; für Linkslenker	24.2122-1724.3 010561	Ø 22,2	
				11/96→; → V1999999; für Linkslenker	24.2122-1724.3 010561	Ø 22,2	
				11/96→; → V5999999; für Linkslenker	24.2122-1724.3 010561	Ø 22,2	
				11/96→; → W1999999; für Rechtslenker	24.2122-1724.3 010561	Ø 22,2	
				W7000001→ W7999999; für Linkslenker	24.2123-1777.3 010943	Ø 23,8	
				W5000001→ W5999999; für Linkslenker	24.2123-1777.3 010943	Ø 23,8	
				W1000001→ W1999999; für Linkslenker	24.2123-1777.3 010943	Ø 23,8	
2.0 DTI 16V	74	08/95→10/01		06/97→; → V5999999; für Linkslenker	24.2122-1724.3 010561	Ø 22,2	
				06/97→; → V1999999; für Linkslenker	24.2122-1724.3 010561	Ø 22,2	
				06/97→; → W1999999; für Rechtslenker	24.2122-1724.3 010561	Ø 22,2	
				06/97→; → W5999999; für Rechtslenker	24.2122-1724.3 010561	Ø 22,2	
				06/97→; → V7999999; für Linkslenker	24.2122-1724.3 010561	Ø 22,2	
				06/97→; → W7999999; für Rechtslenker	24.2122-1724.3 010561	Ø 22,2	
				W7000001→ W7999999; für Linkslenker	24.2123-1777.3 010943	Ø 23,8	
				W5000001→ W5999999; für Linkslenker	24.2123-1777.3 010943	Ø 23,8	
				W1000001→ W1999999; für Linkslenker	24.2123-1777.3 010943	Ø 23,8	
2.0 Dualfuel 2.0 i 16V 2.5 i GSi 2.5 i V6	100 100 143 125	05/98→01/01 10/95→01/01 03/98→07/00 09/95→08/00		→ W1285446; für Linkslenker	03.2123-1622.3 010470	Ø 23,8	
				→ W5276825; für Linkslenker	03.2123-1622.3 010470	Ø 23,8	
				→ W7154258; für Linkslenker	03.2123-1622.3 010470	Ø 23,8	
VAUXHALL - VECTRA Mk II (C) (Z02) 01/00→10/08							
 Hauptbremszylinder							
1.8 1.8 16V 1.8 16V Dualfuel 1.9 CDTI 16V 2.0 DTI 16V 2.2 DTI 16V 3.0 CDTi 3.0 V6 CDTI 3.2 V6 1.9 CDTI	103 90 90 110 74 92 135 130 155 88	01/06→07/08 04/02→07/08 04/02→07/08 04/04→08/08 04/02→10/08 04/02→10/08 08/05→07/08 06/03→08/05 06/03→07/08 04/02→09/08		für Linkslenker; + ESP	24.2125-1732.3 010827	TRW Ø 25,4	
				04/04→; für Linkslenker; + ESP	24.2125-1732.3 010827	TRW Ø 25,4	
				03/03→; für Linkslenker; + ESP	24.2125-1732.3 010827	TRW Ø 25,4	
				04/02→; für Linkslenker; + ESP	24.2125-1732.3 010827	TRW Ø 25,4	
				10/03→; für Linkslenker; + ESP	24.2125-1732.3 010827	TRW Ø 25,4	
VAUXHALL - VECTRA Mk II (C) CC (Z02) 08/02→05/09							
 Hauptbremszylinder							
1.8 1.8 16V 1.8 16V Dualfuel 1.9 CDTI 16V 2.0 16V Turbo 2.0 DTI 16V →	103 90 90 110 129 74	01/06→07/08 08/02→07/08 08/02→07/08 04/04→07/08 03/03→07/08 08/02→07/08		für Linkslenker; + ESP	24.2125-1732.3 010827	TRW Ø 25,4	















	kw					! #		
VAUXHALL - VECTRA Mk II (C) CC (Z02) 08/02→05/09								
 Hauptbremszylinder								
2.2 16V	108	08/02→07/08		für Linkslenker; + ESP		24.2125-1732.3	010827	TRW Ø 25,4
2.2 direct	114	10/03→08/05						
2.2 DTI 16V	92	08/02→07/08						
3.0 CDTi	135	08/05→07/08						
3.0 V6 CDTi	130	06/03→08/05						
3.2 V6	155	08/02→07/08						
1.9 CDTi	88	08/02→07/08		04/04→; für Linkslenker; + ESP		24.2125-1732.3	010827	TRW Ø 25,4
VAUXHALL - VECTRA Mk II (C) Kombi (Z02) 10/03→05/09								
 Hauptbremszylinder								
1.8	103	01/06→07/08		für Linkslenker; + ESP		24.2125-1732.3	010827	TRW Ø 25,4
1.8 16V	90	10/03→08/05						
1.9 CDTi	88	04/04→07/08						
2.0 16V Turbo	129	10/03→07/08						
2.0 DTI 16V	74	10/03→07/08						
2.2 direct	114	10/03→07/08						
2.2 DTI 16V	92	10/03→07/08						
3.0 CDTi	135	08/05→07/08						
3.0 V6 CDTi	130	10/03→08/05						
3.2 V6	155	10/03→08/05						
1.9 CDTi 16V	110	04/04→05/09		für Linkslenker; + ESP; → 10/08		24.2125-1732.3	010827	TRW Ø 25,4
VAUXHALL - VIVARO A Bus (X83) 08/01→07/14								
 Hauptbremszylinder								
1.9 DI	59	08/01→12/06		7V600001 / 7Y000001→; + ABS		24.2120-1748.3	010894	TRW Ø 20,6
1.9 DTI	74	08/01→12/06		7V600001 / 7Y000001→; + ASR		24.2120-1753.3	010946	TRW Ø 20,6
				4V602168→ 6V699999; für Rechtslenker; - ASR		24.2125-1731.3	010826	TRW Ø 25,4
2.0 16V	88	08/01→12/06		7V600001 / 7Y000001→; + ABS		24.2120-1748.3	010894	TRW Ø 20,6
				7V600001 / 7Y000001→; + ASR		24.2120-1753.3	010946	TRW Ø 20,6
				4V602168→ 6V699999; - ASR		24.2125-1731.3	010826	TRW Ø 25,4
2.0 CDTi	66 - 84	01/06→07/14		7V600001 / 7Y000001→; → 06/14; + ABS		24.2120-1748.3	010894	TRW Ø 20,6
2.0 ECOTEC	86	08/06→07/14		7V600001 / 7Y000001→; → 06/14; + ASR		24.2120-1753.3	010946	TRW Ø 20,6
2.5 CDTi	107	01/06→07/14						
2.5 DTI	99	07/03→07/14		4V602168→ 6V699999; - ASR		24.2125-1731.3	010826	TRW Ø 25,4
VAUXHALL - VIVARO A Kasten (X83) 08/01→07/14								
 Hauptbremszylinder								
1.9 DI	59	08/01→12/06		7V600001 / 7Y000001→; + ABS		24.2120-1748.3	010894	TRW Ø 20,6
1.9 DTI	74	08/01→12/06		7V600001 / 7Y000001→; + ASR		24.2120-1753.3	010946	TRW Ø 20,6
				4V602168→ 6V699999; für Rechtslenker; - ASR		24.2125-1731.3	010826	TRW Ø 25,4
2.0 16V	88	08/01→12/06		7V600001 / 7Y000001→; + ABS		24.2120-1748.3	010894	TRW Ø 20,6
				7V600001 / 7Y000001→; + ASR		24.2120-1753.3	010946	TRW Ø 20,6
				4V602168→ 6V699999; - ASR		24.2125-1731.3	010826	TRW Ø 25,4
2.0 CDTi	66 - 84	01/06→07/14		7V600001 / 7Y000001→; → 06/14; + ABS		24.2120-1748.3	010894	TRW Ø 20,6
2.0 ECOTEC	86	08/06→07/14		7V600001 / 7Y000001→; → 06/14; + ASR		24.2120-1753.3	010946	TRW Ø 20,6
2.5 CDTi	107	08/06→07/14						
2.5 DTI	99	07/03→07/14		4V602168→ 6V699999; - ASR		24.2125-1731.3	010826	TRW Ø 25,4
VAUXHALL - VIVARO A Pritsche/Fahrgestell (X83) 04/03→07/14								
 Hauptbremszylinder								
2.0 16V	88	04/03→07/14		7V600001 / 7Y000001→; → 06/14; + ABS		24.2120-1748.3	010894	TRW Ø 20,6
2.0 CDTi	66 - 84	01/06→07/14		7V600001 / 7Y000001→; → 06/14; + ASR		24.2120-1753.3	010946	TRW Ø 20,6
2.0 ECOTEC	86	08/06→07/14						
2.5 CDTi	107	08/06→07/14		4V602168→ 6V699999; - ASR		24.2125-1731.3	010826	TRW Ø 25,4
2.5 CDTi	99	04/03→07/06		7V600001 / 7Y000001→; + ABS		24.2120-1748.3	010894	TRW Ø 20,6
				7V600001 / 7Y000001→; + ASR		24.2120-1753.3	010946	TRW Ø 20,6
				4V602168→ 6V699999; - ASR		24.2125-1731.3	010826	TRW Ø 25,4
VAUXHALL - ZAFIRA A (T98) 11/98→08/05								
 Hauptbremszylinder								
1.6 16V	74	04/99→08/05		- ESP; → 06/05		24.2123-1734.3	010640	TRW Ø 23,8
1.8 16V	92	09/00→08/05						
1.8 Dualfuel	92	09/00→08/05		+ ESP; → 06/05		24.2123-1739.3	010661	Ø 23,8
2.0 DI 16V	60	10/99→08/05						
→								











	kw					! #		
VAUXHALL - ZAFIRA A (T98) 11/98→08/05								
 Hauptbremszylinder								
1.6 CNG	71	09/01→06/05		- ESP		24.2123-1734.3	010640	TRW Ø 23,8
1.8 16V	85	05/99→08/00		+ ESP		24.2123-1739.3	010661	Ø 23,8
2.0	147	06/02→06/05						
2.0 GSI Turbo	141	09/01→06/05						
1.6 Dualfuel	74	11/98→08/05		04/99→; - ESP; → 06/05		24.2123-1734.3	010640	TRW Ø 23,8
				04/99→; + ESP; → 06/05		24.2123-1739.3	010661	Ø 23,8
2.0 DTI 16V	74	04/99→08/05		06/00→; - ESP; → 06/05		24.2123-1734.3	010640	TRW Ø 23,8
				06/00→; + ESP; → 06/05		24.2123-1739.3	010661	Ø 23,8
2.2 16V	108	11/98→08/04		09/00→; - ESP		24.2123-1734.3	010640	TRW Ø 23,8
				09/00→; + ESP		24.2123-1739.3	010661	Ø 23,8
 Bremskraftregler								
1.6 16V	74	04/99→08/05		- ABS; → 06/05		03.6583-0085.3	320238	ATE lastabhängig 8/3 4x
1.8 16V	92	09/00→08/05						
1.8 Dualfuel	92	09/00→08/05						
2.0 DI 16V	60	10/99→08/05						
1.6 CNG	71	09/01→06/05		- ABS		03.6583-0085.3	320238	ATE lastabhängig 8/3 4x
1.8 16V	85	05/99→08/00						
2.0	147	06/02→06/05						
2.0 GSI Turbo	141	09/01→06/05						
1.6 Dualfuel	74	11/98→08/05		04/99→; - ABS; → 06/05		03.6583-0085.3	320238	ATE lastabhängig 8/3 4x
2.0 DTI 16V	74	04/99→08/05		06/00→; - ABS; → 06/05		03.6583-0085.3	320238	ATE lastabhängig 8/3 4x
2.2 16V	108	11/98→08/04		09/00→; - ABS		03.6583-0085.3	320238	ATE lastabhängig 8/3 4x
VAUXHALL - ZAFIRA Mk II (B) (A05) 04/05→11/14								
 Bremskraftverstärker								
1.6	77 - 85	07/05→11/14		für Linkslenker; + ESP		03.7863-7803.4	300237	ATE Ø 10" pneumatisch
1.7 CDTI	81 - 92	01/08→11/14						
1.9 CDTI	88 - 110	07/05→11/14						
2.0	147 - 176	07/05→11/14						
2.2	110	07/05→11/14						
1.8	88	04/13→11/14		06/13→; für Linkslenker; + ESP		03.7863-7803.4	300237	ATE Ø 10" pneumatisch
1.8	103	04/05→11/14		07/05→; für Linkslenker; + ESP		03.7863-7803.4	300237	ATE Ø 10" pneumatisch
 Hauptbremszylinder								
1.6	77	07/05→11/14		für Linkslenker; - ESP		03.4155-0153.3	010927	ATE Ø 25,4
2.0	147 - 176	07/05→11/14		für Linkslenker; + ESP		03.4155-0156.3	010862	ATE Ø 25,4
				→ 6G999999; für Rechtslenker		24.2125-1736.3	010904	TRW Ø 25,4
				72000001→; für Rechtslenker		24.4125-1703.3	010907	TRW Ø 25,4
1.6	85	12/07→11/14		für Linkslenker; - ESP		03.4155-0153.3	010927	ATE Ø 25,4
				für Linkslenker; + ESP		03.4155-0156.3	010862	ATE Ø 25,4
1.7 CDTI	81 - 92	01/08→11/14		für Linkslenker; - ESP		03.4155-0153.3	010927	ATE Ø 25,4
1.9 CDTI	88 - 110	07/05→11/14		für Rechtslenker		03.4155-0156.3	010862	ATE Ø 25,4
2.2	110	07/05→11/14		für Linkslenker; + ESP		03.4155-0156.3	010862	ATE Ø 25,4
1.8	88	04/13→11/14		06/13→; für Linkslenker; - ESP		03.4155-0153.3	010927	ATE Ø 25,4
				06/13→; für Linkslenker; + ESP		03.4155-0156.3	010862	ATE Ø 25,4
				06/13→; für Rechtslenker		24.4125-1703.3	010907	TRW Ø 25,4
1.8	103	04/05→11/14		07/05→; für Linkslenker; - ESP		03.4155-0153.3	010927	ATE Ø 25,4
				07/05→; für Linkslenker; + ESP		03.4155-0156.3	010862	ATE Ø 25,4
				07/05→; → 6G999999; für Rechtslenker		24.2125-1736.3	010904	TRW Ø 25,4
				72000001→; für Rechtslenker		24.4125-1703.3	010907	TRW Ø 25,4
VAUXHALL - ZAFIRA Mk III (P12) 10/11→08/18								
 Bremskraftverstärker								
1.4	88 - 103	10/11→08/18		11/11→; für Linkslenker		03.7858-0732.4	300272	ATE Ø 9 / 8" pneumatisch
1.6 CNG	110	10/11→08/18						
1.8	85 - 103	10/11→08/18						
2.0 CDTi	81 - 121	10/11→08/18						
1.6 CDTi	99 - 100	03/13→08/18		für Linkslenker		03.7858-0732.4	300272	ATE Ø 9 / 8" pneumatisch
1.6 SIDI	147	07/13→08/18						
→								









	kw			 	! #		
VAUXHALL - ZAFIRA Mk III (P12) 10/11→08/18							
 Bremskraftverstärker							
2.0 BiTurbo CDTI 2.0 CDTi	143 125	11/12→08/18 01/15→08/18		für Linkslenker		03.7858-0732.4 300272	ATE Ø 9 / 8" pneumatisch
 Hauptbremszylinder							
1.4 1.6 CNG 1.8 2.0 CDTi	88 - 103 110 85 - 103 81 - 121	10/11→08/18 10/11→08/18 10/11→08/18 10/11→08/18		11/11→; für Linkslenker 11/11→; für Rechtslenker		03.2125-0421.3 010934 24.4155-0201.3 011125	ATE Ø 25,4 ATE Ø 25,4 ohne Bremsflüssigkeitsbehälter
1.6 CDTi 1.6 SIDI 2.0 CDTi	99 - 100 147 125	03/13→08/18 07/13→08/18 01/15→08/18		für Linkslenker für Rechtslenker		03.2125-0421.3 010934 24.4155-0201.3 011125	ATE Ø 25,4 ATE Ø 25,4 ohne Bremsflüssigkeitsbehälter
2.0 BiTurbo CDTI	143	11/12→08/18		für Linkslenker 12/12→; für Rechtslenker		03.2125-0421.3 010934 24.4155-0201.3 011125	ATE Ø 25,4 ATE Ø 25,4 ohne Bremsflüssigkeitsbehälter
VOLVO - C30 (533) 09/06→12/13							
 Bremskraftverstärker							
1.6 1.6 D 1.8 2.0 2.0 D 2.0 FlexFuel 2.4 i D5 Electric T5	74 80 92 107 100 107 125 120 - 132 82 - 89 162 - 184	10/06→12/12 10/06→12/12 10/06→12/12 10/06→12/12 10/06→12/12 01/10→12/12 10/06→12/12 10/06→12/12 12/10→12/12 10/06→12/13		für Linkslenker		03.7863-4832.4 300289	ATE Ø 10" pneumatisch
1.8 FlexFuel	92	01/07→12/12		04/07→; für Linkslenker		03.7863-4832.4 300289	ATE Ø 10" pneumatisch
Pedalwegsensor, Bremspedal							
1.6 1.6 D 1.8 2.0 2.0 D 2.0 FlexFuel 2.4 i D5 T5	74 80 92 107 100 107 125 120 - 132 162 - 184	10/06→12/12 10/06→12/12 10/06→12/12 10/06→12/12 10/06→12/12 01/10→12/12 10/06→12/12 10/06→12/12 10/06→12/13				03.0655-0007.2 370007	ATE
1.8 FlexFuel	92	01/07→12/12		04/07→		03.0655-0007.2 370007	ATE
Electric	82 - 89	12/10→12/12		für Linkslenker		03.0655-0007.2 370007	ATE
 Hauptbremszylinder							
1.6 1.6 D 1.8 2.0 2.0 D 2.0 FlexFuel 2.4 i D5 Electric T5	74 80 92 107 100 107 125 120 - 132 82 - 89 162 - 184	10/06→12/12 10/06→12/12 10/06→12/12 10/06→12/12 10/06→12/12 01/10→12/12 10/06→12/12 10/06→12/12 12/10→12/12 10/06→12/13		für Linkslenker		03.2123-3593.3 010919	ATE Ø 23,8
1.8 FlexFuel	92	01/07→12/12		04/07→; für Linkslenker		03.2123-3593.3 010919	ATE Ø 23,8
D2 D3 D4	84 110 130	10/10→12/12 10/10→12/12 10/10→12/12		für Linkslenker		03.2123-3624.3 010956	ATE Ø 23,8
VOLVO - C70 I Cabriolet (873) 03/98→10/05							
Pedalwegsensor, Bremspedal							
2.0 2.0 T 2.4 2.4 T →	132 166 125 142	03/98→10/05 03/98→10/05 06/98→10/05 03/98→10/05		01/99→		03.0655-0004.2 370004	ATE









	kw					! #		
VOLVO - C70 I Cabriolet (873) 03/98→10/05								
Pedalwegsensord, Bremspedal								
T5	176	03/98→10/05		01/99→			03.0655-0004.2 370004	ATE
2.0 T	120	03/00→10/05					03.0655-0004.2 370004	ATE
2.4 T	147	07/02→10/05						
T5	180	07/02→10/05						
 Hauptbremszylinder								
2.0	132	03/98→10/05		→ 12/98; - ASR			03.2023-1084.3 010591	ATE Ø1 23,8 Ø2 20,6
2.0 T	166	03/98→10/05						
2.4	125	06/98→10/05		01/99→			03.2123-2164.3 010599	ATE Ø 23,8
2.4 T	142	03/98→10/05						
T5	176	03/98→10/05						
2.0 T	120	03/00→10/05					03.2123-2164.3 010599	ATE Ø 23,8
2.4 T	147	07/02→10/05						
T5	180	07/02→10/05						
VOLVO - C70 I Coupe (872) 03/97→09/02								
Pedalwegsensord, Bremspedal								
2.0	132	03/97→09/02		01/99→			03.0655-0004.2 370004	ATE
2.0 T	166	03/97→09/02						
2.4 T	142	03/97→09/02						
T-5	176	03/97→09/02						
2.0 T	120	03/00→09/02					03.0655-0004.2 370004	ATE
2.4	121	03/99→09/02						
2.4	125	05/99→09/02		11/99→			03.0655-0004.2 370004	ATE
 Hauptbremszylinder								
2.0	132	03/97→09/02		→ 12/98; für Linkslenker; - ASR			03.2023-1084.3 010591	ATE Ø1 23,8 Ø2 20,6
2.0 T	166	03/97→09/02						
2.4 T	142	03/97→09/02		01/99→			03.2123-2164.3 010599	ATE Ø 23,8
T-5	176	03/97→09/02						
2.0 T	120	03/00→09/02					03.2123-2164.3 010599	ATE Ø 23,8
2.4	121	03/99→09/02						
2.4	125	05/99→09/02		11/99→			03.2123-2164.3 010599	ATE Ø 23,8
VOLVO - C70 II Cabriolet (542) 03/06→12/13								
 Bremskraftverstärker								
2.0 D	100	01/08→10/09		06/08→; für Linkslenker			03.7863-4832.4 300289	ATE Ø 10" pneumatisch
2.4	103	03/06→10/09		für Linkslenker			03.7863-4832.4 300289	ATE Ø 10" pneumatisch
2.4 D	120	03/07→06/13						
2.4 i	125	03/06→10/09						
D5	132	03/06→06/13						
T5	162 - 169	03/06→06/13						
Pedalwegsensord, Bremspedal								
2.0 D	100	01/08→10/09		06/08→; für Linkslenker			03.0655-0007.2 370007	ATE
				50576→; für Rechtslenker			03.0655-0007.2 370007	ATE
				06/08→; → 50575; für Rechtslenker			03.0655-0007.2 370007	ATE
2.4	103	03/06→10/09					03.0655-0007.2 370007	ATE
2.4 D	120	03/07→06/13						
2.4 i	125	03/06→10/09						
D5	132	03/06→06/13						
T5	162 - 169	03/06→06/13						
 Hauptbremszylinder								
2.0 D	100	01/08→10/09		06/08→; für Linkslenker			03.2123-3593.3 010919	ATE Ø 23,8
2.4	103	03/06→10/09		für Linkslenker			03.2123-3593.3 010919	ATE Ø 23,8
2.4 D	120	03/07→06/13						
2.4 i	125	03/06→10/09						
D5	132	03/06→06/13						
T5	162 - 169	03/06→06/13						
D3	110	10/10→06/13		für Linkslenker			03.2123-3624.3 010956	ATE Ø 23,8
D4	130	10/10→06/13						
VOLVO - S40 I (644) 07/95→12/04								
 Hauptbremszylinder								
1.6	77	09/95→08/99		→ 08/97			24.2122-1718.3 010517	Ø 22,2
1.8	85	07/95→08/99						
1.9 T4	147	05/97→07/00		09/97→			24.2123-1746.3 010682	Ø 23,8
1.9 TD	66	07/95→08/99						
2.0	100 - 103	07/95→12/03						
→								



















	kw			 	! #		
VOLVO - S40 I (644) 07/95→12/04							
 Hauptbremszylinder							
1.6	80	03/99→12/03				24.2123-1746.3 010682	Ø 23,8
1.8	90	03/99→12/03					
1.8 i	90 - 92	03/98→12/03					
1.9 DI	70 - 85	03/99→12/03					
2.0 D	100	12/02→06/04					
2.0 T	120 - 121	07/00→12/03					
2.0 T4	147	07/00→12/03					
2.0 T	118	10/97→12/03		→ 07/00		24.2123-1746.3 010682	Ø 23,8
VOLVO - S40 II (544) 12/03→12/12							
 Bremskraftverstärker							
1.6	74	01/05→12/12		→ 05/12; für Linkslenker		03.7863-4832.4 300289	ATE Ø 10" pneumatisch
1.6 D	81	01/05→12/12					
2.0	107	10/06→12/12					
2.0 F	107	10/09→12/12					
T5	169	03/07→12/12					
1.8	92	04/04→12/10		für Linkslenker		03.7863-4832.4 300289	ATE Ø 10" pneumatisch
2.0 CDI	98	07/05→12/06					
2.0 D	100	01/04→12/10					
2.4	103 - 125	01/04→12/12					
2.4 CDI	120	03/07→12/10					
D4	96	07/05→12/06					
D5	132	03/06→12/10					
T5	162	01/04→12/07					
T5 AWD	162 - 169	04/04→12/10					
1.8 FlexFuel	92	01/06→12/10		04/07→; für Linkslenker		03.7863-4832.4 300289	ATE Ø 10" pneumatisch
Pedalwegsensor, Bremspedal							
1.6	74	01/05→12/12		→ 05/12		03.0655-0007.2 370007	ATE
1.6 D	81	01/05→12/12					
2.0	107	10/06→12/12					
2.0 F	107	10/09→12/12					
T5	169	03/07→12/12					
1.8	92	04/04→12/10				03.0655-0007.2 370007	ATE
2.0 CDI	98	07/05→12/06					
2.0 D	100	01/04→12/10					
2.4	103 - 125	01/04→12/12					
2.4 CDI	120	03/07→12/10					
D4	96	07/05→12/06					
D5	132	03/06→12/10					
T5	162	01/04→12/07					
T5 AWD	162 - 169	04/04→12/10					
1.8 FlexFuel	92	01/06→12/10		04/07→		03.0655-0007.2 370007	ATE
 Hauptbremszylinder							
1.6	74	01/05→12/12		→ 05/12; für Linkslenker		03.2123-3593.3 010919	ATE Ø 23,8
1.6 D	81	01/05→12/12					
2.0	107	10/06→12/12					
2.0 F	107	10/09→12/12					
T5	169	03/07→12/12					
1.8	92	04/04→12/10		für Linkslenker		03.2123-3593.3 010919	ATE Ø 23,8
2.0 CDI	98	07/05→12/06					
2.0 D	100	01/04→12/10					
2.4	103 - 125	01/04→12/12					
2.4 CDI	120	03/07→12/10					
D4	96	07/05→12/06					
D5	132	03/06→12/10					
T5	162	01/04→12/07					
T5 AWD	162 - 169	04/04→12/10					
1.8 FlexFuel	92	01/06→12/10		04/07→; für Linkslenker		03.2123-3593.3 010919	ATE Ø 23,8
D2	84	10/10→12/12		→ 05/12; für Linkslenker		03.2123-3624.3 010956	ATE Ø 23,8
D3	110	10/10→12/12					
D4	130	10/10→12/12					
VOLVO - S60 I (384) 07/00→04/10							
 Bremskraftverstärker							
2.0 T	132	07/00→04/10		09/01→ 12/01		03.7755-3402.4 300189	ATE Ø 9 / 8" pneumatisch
→				01/02→ 01/09; - DSTC		03.7755-4702.4 300224	ATE Ø 9 / 8" pneumatisch











	kw			 	! #		
VOLVO - S60 I (384) 07/00→04/10							
Bremskraftverstärker							
2.0 T	132	07/00→04/10		01/02→ 01/09; + DSTC		03.7858-3532.4 300233	ATE Ø 9 / 8" pneumatisch
2.4	103	07/00→04/10		11/00→ 12/01		03.7755-3402.4 300189	ATE Ø 9 / 8" pneumatisch
2.4 T	147	07/00→04/10		01/02→ 01/09; - DSTC		03.7755-4702.4 300224	ATE Ø 9 / 8" pneumatisch
				01/02→ 01/09; + DSTC		03.7858-3532.4 300233	ATE Ø 9 / 8" pneumatisch
2.4	125	11/00→04/10		→ 12/01		03.7755-3402.4 300189	ATE Ø 9 / 8" pneumatisch
				01/02→ 01/09; - DSTC		03.7755-4702.4 300224	ATE Ø 9 / 8" pneumatisch
				01/02→ 01/09; + DSTC		03.7858-3532.4 300233	ATE Ø 9 / 8" pneumatisch
2.4	132	01/05→10/06		- DSTC		03.7755-4702.4 300224	ATE Ø 9 / 8" pneumatisch
2.4 CDI	85	10/03→12/05		+ DSTC		03.7858-3532.4 300233	ATE Ø 9 / 8" pneumatisch
2.4 D	90	05/05→12/06					
2.4 Bifuel	103	07/01→04/10		06/02→ 01/09; - DSTC		03.7755-4702.4 300224	ATE Ø 9 / 8" pneumatisch
				06/02→ 01/09; + DSTC		03.7858-3532.4 300233	ATE Ø 9 / 8" pneumatisch
2.4 D	93	03/05→04/10		09/05→ 01/09; - DSTC		03.7755-4702.4 300224	ATE Ø 9 / 8" pneumatisch
D5	136	03/05→04/10		09/05→ 01/09; + DSTC		03.7858-3532.4 300233	ATE Ø 9 / 8" pneumatisch
2.4 D	96	05/01→04/10		01/02→ 01/09; - DSTC		03.7755-4702.4 300224	ATE Ø 9 / 8" pneumatisch
				01/02→ 01/09; + DSTC		03.7858-3532.4 300233	ATE Ø 9 / 8" pneumatisch
2.4 T AWD	147	06/01→04/10		11/01→ 12/01		03.7755-3402.4 300189	ATE Ø 9 / 8" pneumatisch
				01/02→ 01/09; - DSTC		03.7755-4702.4 300224	ATE Ø 9 / 8" pneumatisch
				01/02→ 01/09; + DSTC		03.7858-3532.4 300233	ATE Ø 9 / 8" pneumatisch
2.5 T	154	01/03→04/10		02/04→ 01/09; - DSTC		03.7755-4702.4 300224	ATE Ø 9 / 8" pneumatisch
				02/04→ 01/09; + DSTC		03.7858-3532.4 300233	ATE Ø 9 / 8" pneumatisch
2.5 T AWD	154	07/02→04/10		04/04→ 01/09; - DSTC		03.7755-4702.4 300224	ATE Ø 9 / 8" pneumatisch
				04/04→ 01/09; + DSTC		03.7858-3532.4 300233	ATE Ø 9 / 8" pneumatisch
D5	120	01/01→04/10		07/01→ 12/01		03.7755-3402.4 300189	ATE Ø 9 / 8" pneumatisch
				01/02→ 01/09; - DSTC		03.7755-4702.4 300224	ATE Ø 9 / 8" pneumatisch
				01/02→ 01/09; + DSTC		03.7858-3532.4 300233	ATE Ø 9 / 8" pneumatisch
5 T AWD	221	01/03→04/10		03/03→ 01/09; - DSTC		03.7755-4702.4 300224	ATE Ø 9 / 8" pneumatisch
R 2	221	01/03→04/10		03/03→ 01/09; + DSTC		03.7858-3532.4 300233	ATE Ø 9 / 8" pneumatisch
T5	184	07/00→04/10		08/00→ 12/01		03.7755-3402.4 300189	ATE Ø 9 / 8" pneumatisch
				01/02→ 04/04; - DSTC		03.7755-4702.4 300224	ATE Ø 9 / 8" pneumatisch
				01/02→ 04/04; + DSTC		03.7858-3532.4 300233	ATE Ø 9 / 8" pneumatisch
T5	195	07/00→09/02		→ 12/01		03.7755-3402.4 300189	ATE Ø 9 / 8" pneumatisch
				- DSTC		03.7755-4702.4 300224	ATE Ø 9 / 8" pneumatisch
				+ DSTC		03.7858-3532.4 300233	ATE Ø 9 / 8" pneumatisch
T5	191	04/04→04/10		→ 01/09; - DSTC		03.7755-4702.4 300224	ATE Ø 9 / 8" pneumatisch
				→ 01/09; + DSTC		03.7858-3532.4 300233	ATE Ø 9 / 8" pneumatisch
Pedalwegsensord, Bremspedal							
2.0 T	132	07/00→04/10		09/01→ 12/01		03.0655-0004.2 370004	ATE
				01/05→ 01/09		03.0655-0005.2 370005	ATE
				01/02→ 01/09		03.0655-0005.2 370005	ATE
2.4	103	07/00→04/10		11/00→ 12/01		03.0655-0004.2 370004	ATE
2.4 T	147	07/00→04/10		01/05→ 01/09		03.0655-0005.2 370005	ATE
				01/02→ 01/09		03.0655-0005.2 370005	ATE
2.4	125	11/00→04/10		→ 12/01		03.0655-0004.2 370004	ATE
				01/05→ 01/09		03.0655-0005.2 370005	ATE
				01/02→ 01/09		03.0655-0005.2 370005	ATE
2.4	132	01/05→10/06				03.0655-0005.2 370005	ATE
2.4 CDI	85	10/03→12/05					
2.4 D	90	05/05→12/06					
2.4 Bifuel	103	07/01→04/10		01/05→ 01/09		03.0655-0005.2 370005	ATE
				06/02→ 01/09		03.0655-0005.2 370005	ATE
2.4 D	93	03/05→04/10		09/05→ 01/09		03.0655-0005.2 370005	ATE
D5	136	03/05→04/10					
2.4 D	96	05/01→04/10		01/05→ 01/09		03.0655-0005.2 370005	ATE
				01/02→ 01/09		03.0655-0005.2 370005	ATE
2.4 T AWD	147	06/01→04/10		11/01→ 12/01		03.0655-0004.2 370004	ATE
				01/05→ 01/09		03.0655-0005.2 370005	ATE
				01/02→ 01/09		03.0655-0005.2 370005	ATE
2.5 T	154	01/03→04/10		01/05→ 01/09		03.0655-0005.2 370005	ATE
				02/04→ 01/09		03.0655-0005.2 370005	ATE
2.5 T AWD	154	07/02→04/10		01/05→ 01/09		03.0655-0005.2 370005	ATE
→							













	kw			 	! #		
VOLVO - S60 I (384) 07/00→04/10							
Pedalwegsensoren, Bremspedal							
2.5 T AWD	154	07/02→04/10		04/04→ 01/09		03.0655-0005.2 370005	ATE
D5	120	01/01→04/10		07/01→ 12/01		03.0655-0004.2 370004	ATE
				01/05→ 01/09		03.0655-0005.2 370005	ATE
				01/02→ 01/09		03.0655-0005.2 370005	ATE
5 T AWD R 2	221	01/03→04/10		01/05→ 01/09		03.0655-0005.2 370005	ATE
	221	01/03→04/10		03/03→ 01/09		03.0655-0005.2 370005	ATE
T5	184	07/00→04/10		08/00→ 12/01		03.0655-0004.2 370004	ATE
				01/02→ 04/04		03.0655-0005.2 370005	ATE
T5	195	07/00→09/02		→ 12/01		03.0655-0004.2 370004	ATE
						03.0655-0005.2 370005	ATE
T5	191	04/04→04/10		→ 01/09		03.0655-0005.2 370005	ATE
				01/05→ 01/09		03.0655-0005.2 370005	ATE
 Hauptbremszylinder							
2.0 T	132	07/00→04/10		09/01→; → 8535; - DSTC		03.2125-7637.3 010707	ATE Ø 25,4
				09/01→; → 11551; für Rechtslenker; + DSTC		03.2125-7637.3 010707	ATE Ø 25,4
				11552→; → 01/09; für Rechtslenker; + DSTC		03.2125-7638.3 010738	ATE Ø 25,4
				8536→; → 01/09; für Rechtslenker; - DSTC		03.2125-7638.3 010738	ATE Ø 25,4
				09/01→; → 9499; für Linkslenker; + DSTC		03.2125-7708.3 010739	ATE Ø 25,4
				9500→; → 01/09; für Linkslenker; + DSTC		03.2125-7713.3 010819	ATE Ø 25,4
2.4 2.4 T	103	07/00→04/10		11/00→; → 8535; - DSTC		03.2125-7637.3 010707	ATE Ø 25,4
	147	07/00→04/10		11/00→; → 11551; für Rechtslenker; + DSTC		03.2125-7637.3 010707	ATE Ø 25,4
				11552→; → 01/09; für Rechtslenker; + DSTC		03.2125-7638.3 010738	ATE Ø 25,4
				8536→; → 01/09; für Rechtslenker; - DSTC		03.2125-7638.3 010738	ATE Ø 25,4
				11/00→; → 9499; für Linkslenker; + DSTC		03.2125-7708.3 010739	ATE Ø 25,4
				9500→; → 01/09; für Linkslenker; + DSTC		03.2125-7713.3 010819	ATE Ø 25,4
2.4	125	11/00→04/10		→ 8535; - DSTC		03.2125-7637.3 010707	ATE Ø 25,4
				→ 11551; für Rechtslenker; + DSTC		03.2125-7637.3 010707	ATE Ø 25,4
				11552→; → 01/09; für Rechtslenker; + DSTC		03.2125-7638.3 010738	ATE Ø 25,4
				8536→; → 01/09; für Rechtslenker; - DSTC		03.2125-7638.3 010738	ATE Ø 25,4
				→ 9499; für Linkslenker; + DSTC		03.2125-7708.3 010739	ATE Ø 25,4
				9500→; → 01/09; für Linkslenker; + DSTC		03.2125-7713.3 010819	ATE Ø 25,4
2.4 2.4 CDI	132	01/05→10/06		für Linkslenker; + DSTC		03.2125-7713.3 010819	ATE Ø 25,4
	85	10/03→12/05		für Linkslenker; - DSTC		03.2125-7743.3 010921	ATE Ø 25,4
2.4 D	90	05/05→12/06					
2.4 Bifuel	103	07/01→04/10		06/02→; → 11551; für Rechtslenker; + DSTC		03.2125-7637.3 010707	ATE Ø 25,4
				06/02→ 01/09; für Rechtslenker; - DSTC		03.2125-7638.3 010738	ATE Ø 25,4
				11552→; → 01/09; für Rechtslenker; + DSTC		03.2125-7638.3 010738	ATE Ø 25,4
				06/02→; → 9499; für Linkslenker; + DSTC		03.2125-7708.3 010739	ATE Ø 25,4
				9500→; → 01/09; für Linkslenker; + DSTC		03.2125-7713.3 010819	ATE Ø 25,4
				06/02→ 01/09; für Linkslenker; - DSTC		03.2125-7743.3 010921	ATE Ø 25,4
2.4 D D5	93	03/05→04/10		09/05→ 01/09; für Rechtslenker; + DSTC		03.2125-7638.3 010738	ATE Ø 25,4
	136	03/05→04/10		09/05→; für Rechtslenker; → 01/09; - DSTC		03.2125-7638.3 010738	ATE Ø 25,4
				09/05→ 01/09; für Linkslenker; + DSTC		03.2125-7713.3 010819	ATE Ø 25,4
				09/05→ 01/09; für Linkslenker; - DSTC		03.2125-7743.3 010921	ATE Ø 25,4
→							











	kw			 	! #		
VOLVO - S60 I (384) 07/00→04/10							
 Hauptbremszylinder							
2.4 D	96	05/01→04/10	12/01→; → 8535; - DSTC	03.2125-7637.3	010707	ATE Ø 25,4	
			12/01→; → 11551; für Rechtslenker; + DSTC	03.2125-7637.3	010707	ATE Ø 25,4	
			11552→; → 01/09; für Rechtslenker; + DSTC	03.2125-7638.3	010738	ATE Ø 25,4	
			8536→; → 01/09; für Rechtslenker; - DSTC	03.2125-7638.3	010738	ATE Ø 25,4	
			12/01→; → 9499; für Linkslenker; + DSTC	03.2125-7708.3	010739	ATE Ø 25,4	
			9500→; → 01/09; für Linkslenker; + DSTC	03.2125-7713.3	010819	ATE Ø 25,4	
			8536→; → 01/09; für Linkslenker; - DSTC	03.2125-7743.3	010921	ATE Ø 25,4	
2.4 T AWD	147	06/01→04/10	11/01→; → 8535; - DSTC	03.2125-7637.3	010707	ATE Ø 25,4	
			11/01→; → 11551; für Rechtslenker; + DSTC	03.2125-7637.3	010707	ATE Ø 25,4	
			11552→; → 01/09; für Rechtslenker; + DSTC	03.2125-7638.3	010738	ATE Ø 25,4	
			8536→; → 01/09; für Rechtslenker; - DSTC	03.2125-7638.3	010738	ATE Ø 25,4	
			11/01→; → 9499; für Linkslenker; + DSTC	03.2125-7708.3	010739	ATE Ø 25,4	
			9500→; → 01/09; für Linkslenker; + DSTC	03.2125-7713.3	010819	ATE Ø 25,4	
			8536→; → 01/09; für Linkslenker; - DSTC	03.2125-7743.3	010921	ATE Ø 25,4	
2.5 T	154	01/03→04/10	02/04→; → 11551; für Rechtslenker; + DSTC	03.2125-7637.3	010707	ATE Ø 25,4	
			02/04→ 01/09; für Rechtslenker; - DSTC	03.2125-7638.3	010738	ATE Ø 25,4	
			11552→; → 01/09; für Rechtslenker; + DSTC	03.2125-7638.3	010738	ATE Ø 25,4	
			02/04→; → 9499; für Linkslenker; + DSTC	03.2125-7708.3	010739	ATE Ø 25,4	
			9500→; → 01/09; für Linkslenker; + DSTC	03.2125-7713.3	010819	ATE Ø 25,4	
			02/04→ 01/09; für Linkslenker; - DSTC	03.2125-7743.3	010921	ATE Ø 25,4	
2.5 T AWD	154	07/02→04/10	04/04→; → 11551; für Rechtslenker; + DSTC	03.2125-7637.3	010707	ATE Ø 25,4	
			04/04→ 01/09; für Rechtslenker; - DSTC	03.2125-7638.3	010738	ATE Ø 25,4	
			11552→; → 01/09; für Rechtslenker; + DSTC	03.2125-7638.3	010738	ATE Ø 25,4	
			04/04→; → 9499; für Linkslenker; + DSTC	03.2125-7708.3	010739	ATE Ø 25,4	
			9500→; → 01/09; für Linkslenker; + DSTC	03.2125-7713.3	010819	ATE Ø 25,4	
			04/04→ 01/09; für Linkslenker; - DSTC	03.2125-7743.3	010921	ATE Ø 25,4	
D5	120	01/01→04/10	07/01→; → 8535; - DSTC	03.2125-7637.3	010707	ATE Ø 25,4	
			07/01→; → 11551; für Rechtslenker; + DSTC	03.2125-7637.3	010707	ATE Ø 25,4	
			11552→; → 01/09; für Rechtslenker; + DSTC	03.2125-7638.3	010738	ATE Ø 25,4	
			8536→; → 01/09; für Rechtslenker; - DSTC	03.2125-7638.3	010738	ATE Ø 25,4	
			07/01→; → 9499; für Linkslenker; + DSTC	03.2125-7708.3	010739	ATE Ø 25,4	
			9500→; → 01/09; für Linkslenker; + DSTC	03.2125-7713.3	010819	ATE Ø 25,4	
			8536→; → 01/09; für Linkslenker; - DSTC	03.2125-7743.3	010921	ATE Ø 25,4	
5 T AWD R 2	221 221	01/03→04/10 01/03→04/10	03/03→; → 11551; für Rechtslenker; + DSTC	03.2125-7637.3	010707	ATE Ø 25,4	
			03/03→ 01/09; für Rechtslenker; - DSTC	03.2125-7638.3	010738	ATE Ø 25,4	
			11552→; → 01/09; für Rechtslenker; + DSTC	03.2125-7638.3	010738	ATE Ø 25,4	
			03/03→; → 9499; für Linkslenker; + DSTC	03.2125-7708.3	010739	ATE Ø 25,4	
			9500→; → 01/09; für Linkslenker; + DSTC	03.2125-7713.3	010819	ATE Ø 25,4	
			03/03→ 01/09; für Linkslenker; - DSTC	03.2125-7743.3	010921	ATE Ø 25,4	
T5 →	184	07/00→04/10	08/00→; → 8535; - DSTC	03.2125-7637.3	010707	ATE Ø 25,4	
			08/00→; → 11551; für Rechtslenker; + DSTC	03.2125-7637.3	010707	ATE Ø 25,4	

	kw			 	! #		
VOLVO - S60 I (384) 07/00→04/10							
 Hauptbremszylinder							
T5	184	07/00→04/10		11552→; → 04/04; für Rechtslenker; + DSTC	03.2125-7638.3	010738	ATE Ø 25,4
				8536→; → 04/04; für Rechtslenker; - DSTC	03.2125-7638.3	010738	ATE Ø 25,4
				08/00→; → 9499; für Linkslenker; + DSTC	03.2125-7708.3	010739	ATE Ø 25,4
				9500→; → 04/04; für Linkslenker; + DSTC	03.2125-7713.3	010819	ATE Ø 25,4
				8536→; → 04/04; für Linkslenker; - DSTC	03.2125-7743.3	010921	ATE Ø 25,4
T5	195	07/00→09/02		→ 8535; - DSTC	03.2125-7637.3	010707	ATE Ø 25,4
				→ 11551; für Rechtslenker; + DSTC	03.2125-7637.3	010707	ATE Ø 25,4
				8536→; für Rechtslenker; - DSTC	03.2125-7638.3	010738	ATE Ø 25,4
				11552→; für Rechtslenker; + DSTC	03.2125-7638.3	010738	ATE Ø 25,4
				→ 9499; für Linkslenker; + DSTC	03.2125-7708.3	010739	ATE Ø 25,4
				9500→; für Linkslenker; + DSTC	03.2125-7713.3	010819	ATE Ø 25,4
T5	191	04/04→04/10		→ 8536→; für Linkslenker; - DSTC	03.2125-7743.3	010921	ATE Ø 25,4
				→ 11551; für Rechtslenker; + DSTC	03.2125-7637.3	010707	ATE Ø 25,4
				→ 01/09; für Rechtslenker; - DSTC	03.2125-7638.3	010738	ATE Ø 25,4
				11552→; → 01/09; für Rechtslenker; + DSTC	03.2125-7638.3	010738	ATE Ø 25,4
				→ 9499; für Linkslenker; + DSTC	03.2125-7708.3	010739	ATE Ø 25,4
				9500→; → 01/09; für Linkslenker; + DSTC	03.2125-7713.3	010819	ATE Ø 25,4
			→ 01/09; für Linkslenker; - DSTC	03.2125-7743.3	010921	ATE Ø 25,4	
VOLVO - S60 II (134) 04/10→12/19							
 Bremskraftverstärker							
2.0 Polestar AWD	270	06/15→05/18		für Fahrzeuge ohne Kollisionswarner	03.7755-9703.4	300239	ATE Ø 9 / 8" pneumatisch
2.5 T	183	01/13→01/16					
D2	88	03/15→05/18					
D3	110	03/15→05/18					
D4	133 - 140	09/13→05/18					
D4 AWD	140	03/15→05/18					
D4 Drive-E Polestar	147	03/15→05/18					
D5	165	03/15→05/18					
D5 Drive-E Polestar	171	03/15→05/18					
T5	186	09/11→12/15					
T5 AWD	187	08/15→12/18					
2.0 T	132	05/12→12/15		12/13→; für Fahrzeuge ohne Kollisionswarner	03.7755-9703.4	300239	ATE Ø 9 / 8" pneumatisch
Pedalwegsensoren, Bremspedal							
2.0 T	132	05/12→12/15		12/13→; für Fahrzeuge mit Kollisionswarner	03.0655-0007.2	370007	ATE
2.0 T	149	04/10→12/11		für Fahrzeuge mit Kollisionswarner	03.0655-0007.2	370007	ATE
2.5 T	183	01/13→01/16					
D2	88	03/15→05/18					
D3	100 - 120	04/10→05/18					
D4	133 - 140	09/13→05/18					
D4 AWD	140	03/15→05/18					
D4 Drive-E Polestar	147	03/15→05/18					
D5	151 - 169	04/10→05/18					
D5 AWD	151 - 169	04/10→12/15					
D5 Drive-E Polestar	171	03/15→05/18					
DRIVE / D2	84	01/11→12/15					
T2	90	10/15→05/18					
T3	110 - 112	04/10→05/18					
T4	132	04/10→12/15					
T4F	132	04/11→12/15					
T5	177 - 186	04/10→12/18					
T5 AWD	180 - 187	09/12→12/18					
T5 DRIVE	180	09/14→12/15					
T6	225	09/13→12/18					
T6 AWD	224 - 242	04/10→12/18					
D4	120	04/10→12/14		05/12→; für Fahrzeuge mit Kollisionswarner	03.0655-0007.2	370007	ATE
→							













	kw					! #		
VOLVO - S60 II (134) 04/10→12/19								
Pedalwegsensord, Bremspedal								
D5	158	04/11→12/15		06/11→; für Fahrzeuge mit Kollisionswarner		03.0655-0007.2	370007	ATE
D5 AWD	158	04/11→12/15						
T4	140	03/15→05/18		05/15→; für Fahrzeuge mit Kollisionswarner		03.0655-0007.2	370007	ATE
 Hauptbremszylinder								
2.0 Polestar AWD	270	06/15→05/18		für Rechtslenker		24.4156-1391.3	011054	ATE Ø 27 ohne Bremsflüssigkeitsbehälter
2.0 T	132	05/12→12/15		12/13→		24.4156-1391.3	011054	ATE Ø 27 ohne Bremsflüssigkeitsbehälter
D5	165	03/15→05/18				24.4156-1391.3	011054	ATE Ø 27 ohne Bremsflüssigkeitsbehälter
D5 Drive-E Polestar	171	03/15→05/18						
T2	90	10/15→05/18						
T5	186	09/11→12/15						
T5 AWD	186	09/12→12/15						
T6 AWD	225	09/15→12/18						
VOLVO - S60 II Cross Country (134) 03/15→12/18								
 Bremskraftverstärker								
D4	140	03/15→05/18		für Fahrzeuge ohne Kollisionswarner		03.7755-9703.4	300239	ATE Ø 9 / 8" pneumatisch
D4 Polestar AWD	162	03/15→07/18						
T5 AWD	183	03/15→12/18						
D4 AWD	140	03/15→05/18		für Fahrzeuge ohne Kollisionswarner; Ausstattungs-Code: RC01		03.7755-0132.4	300265	ATE Ø 9 / 8" pneumatisch
D4 Drive-E Polestar	147	03/15→05/18						
T5 AWD	187	03/15→12/18		für Fahrzeuge ohne Kollisionswarner; Ausstattungs-Code: RC02		03.7755-9703.4	300239	ATE Ø 9 / 8" pneumatisch
Pedalwegsensord, Bremspedal								
D4 Polestar AWD	162	03/15→07/18		für Fahrzeuge mit Kollisionswarner		03.0655-0007.2	370007	ATE
T5 AWD	183	03/15→12/18						
T5 Drive-E Polestar AWD	186	06/16→05/18						
VOLVO - S70 (874) 11/96→11/00								
 Hauptbremszylinder								
2.0	93 - 132	01/97→11/00		→ 12/98; - ASR		03.2023-1084.3	010591	ATE Ø1 23,8 Ø2 20,6
2.0 Turbo	155 - 166	01/97→11/00		01/99→		03.2123-2164.3	010599	ATE Ø 23,8
2.3 Turbo	184	01/97→11/00						
2.4	106 - 125	01/97→11/00						
2.4 AWD	106 - 121	11/96→05/99						
2.4 Bifuel	106	10/98→11/00						
2.4 T5 AWD	142	11/96→04/99						
2.4 Turbo	142	01/97→11/00						
2.5 TDI	103	01/97→11/00						
T5	176	01/97→11/00						
2.3	177	11/96→11/00		01/97→ 12/98; - ASR		03.2023-1084.3	010591	ATE Ø1 23,8 Ø2 20,6
				01/99→		03.2123-2164.3	010599	ATE Ø 23,8
2.3	195	04/99→09/00				03.2123-2164.3	010599	ATE Ø 23,8
2.4	103	08/99→11/00						
2.4 AWD	103	04/99→09/00						
2.4 Bifuel	103	07/99→11/00						
2.4 Blu-Fuel	103	07/97→09/00						
2.5 TDi AWD	103	10/99→09/00						
2.4 AWD	125	04/99→09/00		→ 05/99		03.2123-2164.3	010599	ATE Ø 23,8
VOLVO - S80 I (184) 05/98→02/08								
 Bremskraftverstärker								
2.0	120	06/98→07/06		→ 12/01; - DSTC		03.7755-3402.4	300189	ATE Ø 9 / 8" pneumatisch
2.0 T	132 - 166	06/98→07/06		01/02→ 02/06; - DSTC		03.7755-4702.4	300224	ATE Ø 9 / 8" pneumatisch
2.4	103 - 125	01/99→07/06		01/02→ 02/06; + DSTC		03.7858-3532.4	300233	ATE Ø 9 / 8" pneumatisch
2.4 Bifuel	103	09/01→07/06						
2.4 D	96	10/01→07/06						
2.4 T	147	06/00→07/06						
2.5 TDI	103	01/99→07/06						
2.9	147 - 150	05/98→07/06						
3.0	144	06/01→07/06						
D5	120	08/01→07/06						
T6	200	06/01→07/06						
2.3 R	195	04/00→08/05		→ 12/01; - DSTC		03.7755-3402.4	300189	ATE Ø 9 / 8" pneumatisch
→								



















	kw					! #		
VOLVO - S80 I (184) 05/98→02/08								
 Bremskraftverstärker								
2.3 R	195	04/00→08/05		01/02→; - DSTC		03.7755-4702.4	300224	ATE Ø 9 / 8" pneumatisch
				01/02→; + DSTC		03.7858-3532.4	300233	ATE Ø 9 / 8" pneumatisch
2.5 T	154	03/03→07/06		07/03→ 02/06; - DSTC		03.7755-4702.4	300224	ATE Ø 9 / 8" pneumatisch
				07/03→ 02/06; + DSTC		03.7858-3532.4	300233	ATE Ø 9 / 8" pneumatisch
2.5 T AWD	154	07/03→07/06		→ 02/06; - DSTC		03.7755-4702.4	300224	ATE Ø 9 / 8" pneumatisch
				→ 02/06; + DSTC		03.7858-3532.4	300233	ATE Ø 9 / 8" pneumatisch
T5 AWD	147	04/00→09/03		06/00→ 12/01; - DSTC		03.7755-3402.4	300189	ATE Ø 9 / 8" pneumatisch
				01/02→; - DSTC		03.7755-4702.4	300224	ATE Ø 9 / 8" pneumatisch
				01/02→; + DSTC		03.7858-3532.4	300233	ATE Ø 9 / 8" pneumatisch
T6	200	05/98→12/01		- DSTC		03.7755-3402.4	300189	ATE Ø 9 / 8" pneumatisch
Pedalwegsensor, Bremspedal								
2.0	120	06/98→07/06		→ 12/01		03.0655-0004.2	370004	ATE
2.0 T	132 - 166	06/98→07/06		01/02→ 02/06		03.0655-0005.2	370005	ATE
2.4	103 - 125	01/99→07/06						
2.4 Bifuel	103	09/01→07/06						
2.4 D	96	10/01→07/06						
2.4 T	147	06/00→07/06						
2.5 TDI	103	01/99→07/06						
2.9	147 - 150	05/98→07/06						
3.0	144	06/01→07/06						
D5	120	08/01→07/06						
T6	200	06/01→07/06						
2.3 R	195	04/00→08/05		→ 12/01		03.0655-0004.2	370004	ATE
				01/02→		03.0655-0005.2	370005	ATE
2.5 T	154	03/03→07/06		07/03→ 02/06		03.0655-0005.2	370005	ATE
2.5 T AWD	154	07/03→07/06		→ 02/06		03.0655-0005.2	370005	ATE
T5 AWD	147	04/00→09/03		06/00→ 12/01		03.0655-0004.2	370004	ATE
				01/02→		03.0655-0005.2	370005	ATE
T6	200	05/98→12/01				03.0655-0004.2	370004	ATE
 Hauptbremszylinder								
2.0	120	06/98→07/06		→ 174095; - DSTC		03.2125-7637.3	010707	ATE Ø 25,4
2.0 T	166	06/98→07/06		→ 02/06; 174096→; für Rechtslenker		03.2125-7638.3	010738	ATE Ø 25,4
2.4	103 - 125	01/99→07/06		→ 174095; + DSTC		03.2125-7708.3	010739	ATE Ø 25,4
2.5 TDI	103	01/99→07/06		→ 02/06; 174096→; für Linkslenker; + DSTC		03.2125-7713.3	010819	ATE Ø 25,4
2.9	147 - 150	05/98→07/06		→ 02/06; 174096→; für Linkslenker; - DSTC		03.2125-7743.3	010921	ATE Ø 25,4
2.0 T	132	12/99→07/06		→ 02/06; für Rechtslenker		03.2125-7638.3	010738	ATE Ø 25,4
2.4 Bifuel	103	09/01→07/06		→ 02/06; für Linkslenker; + DSTC		03.2125-7713.3	010819	ATE Ø 25,4
2.4 D	96	10/01→07/06		→ 02/06; für Linkslenker; - DSTC		03.2125-7743.3	010921	ATE Ø 25,4
2.4 T	147	06/00→07/06						
2.5 T AWD	154	07/03→07/06						
3.0	144	06/01→07/06						
D5	120	08/01→07/06						
T6	200	06/01→07/06						
2.3 R	195	04/00→08/05		→ 174095; - DSTC		03.2125-7637.3	010707	ATE Ø 25,4
T6	200	05/98→12/01		174096→; für Rechtslenker		03.2125-7638.3	010738	ATE Ø 25,4
				→ 174095; + DSTC		03.2125-7708.3	010739	ATE Ø 25,4
				174096→; für Linkslenker; + DSTC		03.2125-7713.3	010819	ATE Ø 25,4
				174096→; für Linkslenker; - DSTC		03.2125-7743.3	010921	ATE Ø 25,4
2.5 T	154	03/03→07/06		07/03→ 02/06; für Rechtslenker		03.2125-7638.3	010738	ATE Ø 25,4
				07/03→ 02/06; für Linkslenker; + DSTC		03.2125-7713.3	010819	ATE Ø 25,4
				07/03→ 02/06; für Linkslenker; - DSTC		03.2125-7743.3	010921	ATE Ø 25,4
T5 AWD	147	04/00→09/03		06/00→; für Rechtslenker		03.2125-7638.3	010738	ATE Ø 25,4
				06/00→; für Linkslenker; + DSTC		03.2125-7713.3	010819	ATE Ø 25,4
				06/00→; für Linkslenker; - DSTC		03.2125-7743.3	010921	ATE Ø 25,4
VOLVO - S80 II (124) 03/06→12/16								
 Bremskraftverstärker								
1.6 D DRIVE	80	01/10→12/11		für Linkslenker; für Fahrzeuge ohne Kollisionswarner		03.7755-9703.4	300239	ATE Ø 9 / 8" pneumatisch
1.6 DRIVE	84	06/11→01/14						
D2	85	01/14→12/16		für Linkslenker; → 151000; für Fahrzeuge mit Kollisionswarner		03.7858-5032.4	300275	ATE Ø 9 / 8" pneumatisch
D3 / D4	120	01/10→12/16						
→								







	kw			 	! #		
VOLVO - S80 II (124) 03/06→12/16							
 Bremskraftverstärker							
2.0 2.0 FlexFuel 2.0 T 2.0 TDi 2.4 D 2.5 T 2.5 T FlexFuel 3.2 3.2 AWD 3.2 Flexifuel AWD D5 D5 AWD T6 AWD	107 107 149 100 120 - 129 147 147 175 - 179 175 - 179 177 136 - 151 136 - 151 210	01/08→09/12 01/08→12/11 01/10→05/11 02/08→03/11 03/06→03/11 03/06→12/11 05/08→12/11 03/06→12/14 01/07→12/12 01/09→03/10 03/06→12/11 01/07→12/11 01/07→12/10		für Linkslenker; für Fahrzeuge ohne Kollisionswarner	03.7755-9703.4	300239	ATE Ø 9 / 8" pneumatisch
2.0 Drive- E T5	180 162 - 180	12/14→12/16 10/10→12/16		für Linkslenker; für Fahrzeuge ohne Kollisionswarner	03.7755-9703.4	300239	ATE Ø 9 / 8" pneumatisch
				für Linkslenker; für Fahrzeuge mit Kollisionswarner	03.7858-5032.4	300275	ATE Ø 9 / 8" pneumatisch
2.5 T 2.5 T FlexFuel D3 D5 D5 AWD T4 T4F T6 AWD	170 170 100 158 158 132 132 224	01/10→12/12 01/10→12/11 05/12→05/14 06/11→04/15 06/11→04/15 10/10→04/14 05/11→01/14 10/10→12/16		für Fahrzeuge ohne Kollisionswarner	03.7755-9703.4	300239	ATE Ø 9 / 8" pneumatisch
				→ 151000; für Fahrzeuge mit Kollisionswarner	03.7858-5032.4	300275	ATE Ø 9 / 8" pneumatisch
2.5 T D4	183 - 187 133	01/12→12/16 09/13→12/16		für Fahrzeuge ohne Kollisionswarner	03.7755-9703.4	300239	ATE Ø 9 / 8" pneumatisch
Pedalwegsensor, Bremspedal							
1.6 D DRIVE 1.6 DRIVE D2 D3 / D4	80 84 85 120	01/10→12/11 06/11→01/14 01/14→12/16 01/10→12/16		für Rechtslenker	03.0655-0007.2	370007	ATE
				für Linkslenker; → 151000	03.0655-0007.2	370007	ATE
				151001→; für Linkslenker; für Fahrzeuge mit Kollisionswarner	03.0655-0007.2	370007	ATE
2.0 2.0 FlexFuel 2.0 T 2.0 TDi 2.4 D 2.5 T 2.5 T FlexFuel 3.2 3.2 AWD 3.2 Flexifuel AWD D5 D5 AWD T6 AWD	107 107 149 100 120 - 129 147 147 175 - 179 175 - 179 177 136 - 151 136 - 151 210	01/08→09/12 01/08→12/11 01/10→05/11 02/08→03/11 03/06→03/11 03/06→12/11 05/08→12/11 03/06→12/14 01/07→12/12 01/09→03/10 03/06→12/11 01/07→12/11 01/07→12/10		für Rechtslenker	03.0655-0007.2	370007	ATE
				für Linkslenker; für Fahrzeuge mit Kollisionswarner	03.0655-0007.2	370007	ATE
2.0 Drive- E	180	12/14→12/16		für Linkslenker; für Fahrzeuge mit Kollisionswarner	03.0655-0007.2	370007	ATE
2.5 T 2.5 T FlexFuel D3 D5 D5 AWD T4 T4F T6 AWD	170 170 100 158 158 132 132 224	01/10→12/12 01/10→12/11 05/12→05/14 06/11→04/15 06/11→04/15 10/10→04/14 05/11→01/14 10/10→12/16		→ 151000	03.0655-0007.2	370007	ATE
				151001→; für Fahrzeuge mit Kollisionswarner	03.0655-0007.2	370007	ATE
2.5 T D4 T5	183 - 187 133 162 - 180	01/12→12/16 09/13→12/16 10/10→12/16		für Fahrzeuge mit Kollisionswarner	03.0655-0007.2	370007	ATE
 Hauptbremszylinder							
T5	162	01/14→12/16			24.4156-1391.3	011054	ATE Ø 27 ohne Bremsflüssigkeitsbehälter
VOLVO - V40 Cross Country (526) 09/13→12/15							
 Hauptbremszylinder							
1.6 D2/ DRIVE	84	09/13→12/15		für Fahrzeuge ohne Kollisionswarner	03.2125-5016.3	011010	ATE Ø 25,4









	kW			 	! #		
VOLVO - V40 Cross Country (526) 10/12→08/19							
 Hauptbremszylinder							
D2	84 - 88	10/12→08/19		Ausstattungs-Code: KI01		03.2125-5016.3 011010	ATE Ø 25,4
D3	110	04/15→08/19					
T3	112	02/15→08/19		für Fahrzeuge ohne Kollisionswarner		03.2125-5016.3 011010	ATE Ø 25,4
T4	140	08/15→08/19					
T4 GTDi	132	10/12→12/16				03.2125-5016.3 011010	ATE Ø 25,4
VOLVO - V40 Kasten/Schrägheck (525) 09/13→12/15							
 Hauptbremszylinder							
1.6 D2/ DRiVe	84	09/13→12/15		für Fahrzeuge ohne Kollisionswarner		03.2125-5016.3 011010	ATE Ø 25,4
2.0 D3	110	09/13→12/15					
2.0 D4	130	09/13→12/14					
VOLVO - V40 Kombi (645) 07/95→06/04							
 Hauptbremszylinder							
1.6	77	12/95→08/99		→ 08/97		24.2122-1718.3 010517	Ø 22,2
1.8	85	07/95→08/99					
1.9 TD	66	07/95→08/99		09/97→		24.2123-1746.3 010682	Ø 23,8
2.0	100 - 103	07/95→06/04					
1.6	80	03/99→06/04				24.2123-1746.3 010682	Ø 23,8
1.8	90	03/99→06/04					
1.8 Bi-Fuel	88	11/99→08/03					
1.8 Blu-Fuel	85	06/01→08/03					
1.8 i	90 - 92	03/98→06/04					
1.8 LPG	90	03/99→06/04					
1.9	127	09/03→06/04					
1.9 DI	70 - 85	03/99→06/04					
2.0 T	118 - 120	10/97→06/04					
1.9 T4	147	05/97→07/00		→ 08/97; + ABS		24.2122-1718.3 010517	Ø 22,2
				09/97→		24.2123-1746.3 010682	Ø 23,8
2.0 T	121	07/99→06/04		07/00→ 06/01		24.2123-1746.3 010682	Ø 23,8
2.0 T4	147	07/00→06/04		→ 04/04		24.2123-1746.3 010682	Ø 23,8
VOLVO - V40 Schrägheck (525) 03/12→08/19							
 Hauptbremszylinder							
D2	84	03/12→12/16		09/12→; für Fahrzeuge ohne Kollisionswarner		03.2125-5016.3 011010	ATE Ø 25,4
D3	110	03/12→03/15					
D4	130	03/12→12/14					
T3 GTDi	110	03/12→12/16					
T4 GTDi	132	03/12→12/16					
D3	110	04/15→08/19		für Fahrzeuge ohne Kollisionswarner		03.2125-5016.3 011010	ATE Ø 25,4
T4	132 - 147	07/13→12/15					
VOLVO - V50 (545) 12/03→12/12							
 Bremskraftverstärker							
1.6	74	01/05→12/12		→ 05/12; für Linkslenker		03.7863-4832.4 300289	ATE Ø 10" pneumatisch
1.6 D	80	03/05→12/12					
2.0	107	10/06→12/12					
2.0 FlexFuel	107	01/10→12/12					
T5	169	03/07→12/12					
1.6 D	81	01/05→12/11		für Linkslenker		03.7863-4832.4 300289	ATE Ø 10" pneumatisch
1.8	92	04/04→12/10					
1.8 BiFuel	93	01/09→09/10					
1.8 FlexFuel	92	01/05→12/10					
2.0 CDI	98	12/03→12/06					
2.0 D	100	04/04→12/10					
2.0 D4	96	07/05→12/06					
2.4	103 - 125	04/04→12/10					
2.4 AWD	125	08/06→12/09					
2.4 Tdi	120	05/07→12/10					
D5	132	03/06→12/10					
T5	162	04/04→12/07					
T5 AWD	162 - 169	04/04→12/10					
Pedalwegsensor, Bremspedal							
1.6	74	01/05→12/12		→ 05/12		03.0655-0007.2 370007	ATE
1.6 D	80	03/05→12/12					
2.0	107	10/06→12/12					
2.0 FlexFuel	107	01/10→12/12					
→							

	kW			 	! #		
VOLVO - V50 (545) 12/03→12/12							
Pedalwegsensoren, Bremspedal							
T5	169	03/07→12/12		→ 05/12		03.0655-0007.2 370007	ATE
1.6 D	81	01/05→12/11				03.0655-0007.2 370007	ATE
1.8	92	04/04→12/10					
1.8 BiFuel	93	01/09→09/10					
1.8 FlexFuel	92	01/05→12/10					
2.0 CDI	98	12/03→12/06					
2.0 D	100	04/04→12/10					
2.0 D4	96	07/05→12/06					
2.4	103 - 125	04/04→12/10					
2.4 AWD	125	08/06→12/09					
2.4 Tdi	120	05/07→12/10					
D5	132	03/06→12/10					
T5	162	04/04→12/07					
T5 AWD	162 - 169	04/04→12/10					
Hauptbremszylinder							
1.6	74	01/05→12/12		→ 05/12; für Linkslenker		03.2123-3593.3 010919	ATE Ø 23,8
1.6 D	80	03/05→12/12					
2.0	107	10/06→12/12					
2.0 FlexFuel	107	01/10→12/12					
T5	169	03/07→12/12					
1.6 D	81	01/05→12/11		für Linkslenker		03.2123-3593.3 010919	ATE Ø 23,8
1.8	92	04/04→12/10					
1.8 BiFuel	93	01/09→09/10					
1.8 FlexFuel	92	01/05→12/10					
2.0 CDI	98	12/03→12/06					
2.0 D	100	04/04→12/10					
2.0 D4	96	07/05→12/06					
2.4	103 - 125	04/04→12/10					
2.4 AWD	125	08/06→12/09					
2.4 Tdi	120	05/07→12/10					
D5	132	03/06→12/10					
T5	162	04/04→12/07					
T5 AWD	162 - 169	04/04→12/10					
D2	84	01/10→12/12		→ 05/12; für Linkslenker		03.2123-3624.3 010956	ATE Ø 23,8
D3	110	10/10→12/12					
D4	130	10/10→12/12					
VOLVO - V60 I (155) 07/10→12/18							
Bremskraftverstärker							
2.0 BiFuel	157	03/14→12/15		für Fahrzeuge ohne Kollisionswarner		03.7755-9703.4 300239	ATE Ø 9 / 8" pneumatisch
2.0 Polestar AWD	270	06/15→05/18					
2.0 T	132	01/14→07/18					
D2	88	03/15→05/18					
D3	110	03/15→05/18					
D4	133 - 140	10/13→05/18					
D4 AWD	133 - 140	10/13→05/18					
D5	165	03/15→05/18					
D6 Hybrid AWD	206	03/15→05/18					
T5	162	01/14→12/17					
T6	224	07/14→04/15					
T6 AWD	242	04/14→12/15					
3.0 T AWD	258	04/14→05/18		05/14→; für Fahrzeuge ohne Kollisionswarner		03.7755-9703.4 300239	ATE Ø 9 / 8" pneumatisch
D4 AWD	120	05/12→12/15		12/12→; für Fahrzeuge ohne Kollisionswarner		03.7755-9703.4 300239	ATE Ø 9 / 8" pneumatisch
T5	157	10/13→05/18		04/14→; für Fahrzeuge ohne Kollisionswarner		03.7755-9703.4 300239	ATE Ø 9 / 8" pneumatisch
T5 AWD	180 - 187	07/14→05/18		für Fahrzeuge ohne Kollisionswarner; Ausstattungs-Code: RC01		03.7755-0132.4 300265	ATE Ø 9 / 8" pneumatisch
				für Fahrzeuge ohne Kollisionswarner; Ausstattungs-Code: RC02		03.7755-9703.4 300239	ATE Ø 9 / 8" pneumatisch
Pedalwegsensoren, Bremspedal							
1.6 DRIVE	84	02/11→12/15		06/11→; für Fahrzeuge mit Kollisionswarner		03.0655-0007.2 370007	ATE
D5	158	04/11→12/15					
D5 AWD	158	04/11→12/15					
2.0 T	149	07/10→12/12		11/10→; für Fahrzeuge mit Kollisionswarner		03.0655-0007.2 370007	ATE
D3 / D4	120	07/10→12/14					
D5	151	07/10→12/11					
D5 AWD	151	07/10→12/11					
T3	110	09/10→12/15					
T4	132	09/10→12/15					
T5	177	09/10→12/14					
→							







	kw			 	! #		
VOLVO - V60 I (155) 07/10→12/18							
Pedalwegsensord, Bremspedal							
T6 AWD	224	07/10→12/15		11/10→; für Fahrzeuge mit Kollisionswarner		03.0655-0007.2 370007	ATE
D2 D3 D4 D4 AWD D5 D5 AWD D5 Hybrid AWD D6 Hybrid AWD T3 T4F T5 T6 T6 AWD	88 110 133 - 140 133 - 140 165 - 169 169 169 206 112 132 176 - 180 224 - 225 225 - 242	03/15→05/18 03/15→05/18 10/13→05/18 10/13→05/18 04/14→05/18 04/14→12/15 03/15→05/18 03/15→05/18 03/15→05/18 04/11→12/15 08/12→12/18 10/13→12/18 10/13→12/18		für Fahrzeuge mit Kollisionswarner		03.0655-0007.2 370007	ATE
D3	100	05/12→12/15		10/12→; für Fahrzeuge mit Kollisionswarner		03.0655-0007.2 370007	ATE
D4 AWD	120	05/12→12/15		12/12→; für Fahrzeuge mit Kollisionswarner		03.0655-0007.2 370007	ATE
D6 Hybrid AWD	206	06/12→12/15		11/12→; für Fahrzeuge mit Kollisionswarner		03.0655-0007.2 370007	ATE
T2	90	10/15→03/17		01/16→; für Fahrzeuge mit Kollisionswarner		03.0655-0007.2 370007	ATE
T4	140	03/15→05/18		05/15→; für Fahrzeuge mit Kollisionswarner		03.0655-0007.2 370007	ATE
T5	157	10/13→05/18		04/14→; für Fahrzeuge mit Kollisionswarner		03.0655-0007.2 370007	ATE
 Hauptbremszylinder							
2.0 BiFuel 2.0 T D2 D5 Hybrid AWD D6 Hybrid AWD T5	157 132 88 169 206 162	03/14→12/15 01/14→07/18 03/15→05/18 03/15→05/18 03/15→05/18 01/14→12/17				24.4156-1391.3 011054	ATE Ø 27 ohne Bremsflüssigkeitsbehälter
2.0 Polestar AWD	270	06/15→05/18		für Rechtslenker		24.4156-1391.3 011054	ATE Ø 27 ohne Bremsflüssigkeitsbehälter
T2	90	10/15→03/17		01/16→		24.4156-1391.3 011054	ATE Ø 27 ohne Bremsflüssigkeitsbehälter
VOLVO - V60 I Cross Country (157) 09/10→12/18							
 Bremskraftverstärker							
D2 D3 D4 D4 AWD D5 D5 Hybrid AWD T5 T5 AWD T5 Drive-E Polestar T5 Drive-E Polestar AWD	88 110 140 140 165 169 180 180 187 186 186	03/15→05/18 03/15→05/18 03/15→05/18 03/15→05/18 03/15→05/18 03/15→05/18 03/15→05/18 03/15→05/18 03/15→07/18 03/15→07/18		für Fahrzeuge ohne Kollisionswarner; Ausstattungs-Code: RC01		03.7755-0132.4 300265	ATE Ø 9 / 8" pneumatisch
D4 AWD D5 D5 Hybrid AWD T5 T5 AWD T5 Drive-E Polestar T5 Drive-E Polestar AWD	140 165 169 180 180 186 186	03/15→05/18 03/15→05/18 03/15→05/18 03/15→05/18 03/15→05/18 03/15→07/18 03/15→07/18		für Fahrzeuge ohne Kollisionswarner; Ausstattungs-Code: RC02		03.7755-9703.4 300239	ATE Ø 9 / 8" pneumatisch
D4 Polestar AWD	147 - 162	03/15→05/18		für Fahrzeuge ohne Kollisionswarner		03.7755-9703.4 300239	ATE Ø 9 / 8" pneumatisch
Pedalwegsensord, Bremspedal							
D4 Drive-E Polestar	147	03/15→05/18		05/15→; für Fahrzeuge mit Kollisionswarner		03.0655-0007.2 370007	ATE
D4 Polestar AWD	147 - 162	03/15→05/18		für Fahrzeuge mit Kollisionswarner		03.0655-0007.2 370007	ATE
VOLVO - V60 I Kasten/Kombi (155) 09/13→12/15							
 Bremskraftverstärker							
2.4 D4 AWD	133	09/13→12/15		für Fahrzeuge ohne Kollisionswarner		03.7755-9703.4 300239	ATE Ø 9 / 8" pneumatisch
Pedalwegsensord, Bremspedal							
1.6 DRIVE 2.0 D3 2.0 D4 →	84 100 120	09/13→12/15 09/13→12/15 09/13→12/15		für Fahrzeuge mit Kollisionswarner		03.0655-0007.2 370007	ATE









	kw					! #		
VOLVO - V60 I Kasten/Kombi (155) 09/13→12/15								
Pedalwegsensoren, Bremspedal								
2.4 D4 AWD	133	09/13→12/15		für Fahrzeuge mit Kollisionswarner		03.0655-0007.2	370007	ATE
2.4 D5	158	09/13→12/15						
VOLVO - V70 I (875, 876) 12/95→12/00								
Hauptbremszylinder								
2.0	93 - 132	12/95→03/00		01/97→ 12/98; - ASR		03.2023-1084.3	010591	ATE Ø1 23,8 Ø2 20,6
2.0 Turbo	155	12/95→03/00		01/99→		03.2123-2164.3	010599	ATE Ø 23,8
2.3 Turbo	184	12/95→03/00						
2.4	106	12/95→03/00						
2.5 TDi AWD	103	11/96→02/00						
2.0	120	01/97→12/00		→ 12/98; - ASR		03.2023-1084.3	010591	ATE Ø1 23,8 Ø2 20,6
2.3 T-5 AWD	176	01/97→12/00		01/99→ 03/00		03.2123-2164.3	010599	ATE Ø 23,8
2.0 Turbo	166	11/96→12/00		01/97→ 12/98; - ASR		03.2023-1084.3	010591	ATE Ø1 23,8 Ø2 20,6
2.0 Turbo AWD	166	11/96→12/00						
2.3	177	11/96→11/00		01/99→ 03/00		03.2123-2164.3	010599	ATE Ø 23,8
2.3 T-5	176	11/96→12/00						
2.4	125	12/95→05/00						
2.4 Turbo	142	04/96→12/00						
2.4 Turbo AWD	142	04/96→12/00						
2.5 TDI	103	12/95→12/00						
2.3 AWD	195	12/98→02/00		01/99→ 05/99		03.2123-2164.3	010599	ATE Ø 23,8
2.3 T AWD	184	04/97→03/00		→ 12/98; - ASR		03.2023-1084.3	010591	ATE Ø1 23,8 Ø2 20,6
2.4	121	06/98→12/99		01/99→		03.2123-2164.3	010599	ATE Ø 23,8
2.4	103	03/99→12/00		08/99→ 03/00		03.2123-2164.3	010599	ATE Ø 23,8
2.4 AWD	121	06/98→12/99		10/98→ 05/99; - ASR		03.2023-1084.3	010591	ATE Ø1 23,8 Ø2 20,6
				01/99→ 05/99		03.2123-2164.3	010599	ATE Ø 23,8
2.4 Bifuel	103	08/99→12/00		→ 03/00		03.2123-2164.3	010599	ATE Ø 23,8
2.4 Turbo AWD	195	03/99→12/00						
2.4 Bifuel	106	05/98→12/99		10/98→ 12/98; - ASR		03.2023-1084.3	010591	ATE Ø1 23,8 Ø2 20,6
				01/99→ 08/99		03.2123-2164.3	010599	ATE Ø 23,8
VOLVO - V70 II (285) 11/99→12/08								
Bremskraftverstärker								
2.0 T	132	11/99→08/07		07/01→ 12/01; - DSTC		03.7755-3402.4	300189	ATE Ø 9 / 8" pneumatisch
				01/02→ 07/07; - DSTC		03.7755-4702.4	300224	ATE Ø 9 / 8" pneumatisch
				01/02→ 07/07; + DSTC		03.7858-3532.4	300233	ATE Ø 9 / 8" pneumatisch
2.3	195	10/00→09/04		→ 12/01; - DSTC		03.7755-3402.4	300189	ATE Ø 9 / 8" pneumatisch
				- DSTC		03.7755-4702.4	300224	ATE Ø 9 / 8" pneumatisch
				+ DSTC		03.7858-3532.4	300233	ATE Ø 9 / 8" pneumatisch
2.4	103 - 125	03/00→08/07		→ 12/01; - DSTC		03.7755-3402.4	300189	ATE Ø 9 / 8" pneumatisch
2.4 Bifuel	103	09/01→08/07		01/02→ 07/07; - DSTC		03.7755-4702.4	300224	ATE Ø 9 / 8" pneumatisch
				01/02→ 07/07; + DSTC		03.7858-3532.4	300233	ATE Ø 9 / 8" pneumatisch
2.4 CDI	90	07/05→12/08		- DSTC		03.7755-4702.4	300224	ATE Ø 9 / 8" pneumatisch
2.5 AWD	155	09/02→12/04		+ DSTC		03.7858-3532.4	300233	ATE Ø 9 / 8" pneumatisch
2.4 D	93	04/05→12/08		05/05→ 07/07; - DSTC		03.7755-4702.4	300224	ATE Ø 9 / 8" pneumatisch
				05/05→ 07/07; + DSTC		03.7858-3532.4	300233	ATE Ø 9 / 8" pneumatisch
2.4 D	96	07/01→08/07		12/01→ 12/01; - DSTC		03.7755-3402.4	300189	ATE Ø 9 / 8" pneumatisch
				01/02→ 07/07; - DSTC		03.7755-4702.4	300224	ATE Ø 9 / 8" pneumatisch
				01/02→ 07/07; + DSTC		03.7858-3532.4	300233	ATE Ø 9 / 8" pneumatisch
2.4 T	147	11/99→08/03		03/00→ 12/01; - DSTC		03.7755-3402.4	300189	ATE Ø 9 / 8" pneumatisch
T5	184	11/99→12/04		01/02→; - DSTC		03.7755-4702.4	300224	ATE Ø 9 / 8" pneumatisch
				01/02→; + DSTC		03.7858-3532.4	300233	ATE Ø 9 / 8" pneumatisch
2.4 T AWD	147	09/01→08/02		→ 12/01; - DSTC		03.7755-3402.4	300189	ATE Ø 9 / 8" pneumatisch
				01/02→; - DSTC		03.7755-4702.4	300224	ATE Ø 9 / 8" pneumatisch
				01/02→; + DSTC		03.7858-3532.4	300233	ATE Ø 9 / 8" pneumatisch
2.5 T	154	07/01→08/07		04/04→ 07/07; - DSTC		03.7755-4702.4	300224	ATE Ø 9 / 8" pneumatisch
				04/04→ 07/07; + DSTC		03.7858-3532.4	300233	ATE Ø 9 / 8" pneumatisch
2.5 T AWD	154	07/02→08/07		09/02→ 07/07; - DSTC		03.7755-4702.4	300224	ATE Ø 9 / 8" pneumatisch
				09/02→ 07/07; + DSTC		03.7858-3532.4	300233	ATE Ø 9 / 8" pneumatisch
2.5 TDI	103	11/99→08/07		03/00→ 12/01; - DSTC		03.7755-3402.4	300189	ATE Ø 9 / 8" pneumatisch
				01/02→ 07/07; - DSTC		03.7755-4702.4	300224	ATE Ø 9 / 8" pneumatisch
				01/02→ 07/07; + DSTC		03.7858-3532.4	300233	ATE Ø 9 / 8" pneumatisch
D5	120	01/01→12/08		08/01→ 12/01; - DSTC		03.7755-3402.4	300189	ATE Ø 9 / 8" pneumatisch
				01/02→ 07/07; - DSTC		03.7755-4702.4	300224	ATE Ø 9 / 8" pneumatisch
→								

















	kw			 	! #		
VOLVO - V70 II (285) 11/99→12/08							
Bremskraftverstärker							
D5	120	01/01→12/08		01/02→ 07/07; + DSTC		03.7858-3532.4 300233	ATE Ø 9 / 8" pneumatisch
D5	136	04/05→12/08		12/05→ 07/07; - DSTC		03.7755-4702.4 300224	ATE Ø 9 / 8" pneumatisch
D5 AWD	136	05/05→08/07		12/05→ 07/07; + DSTC		03.7858-3532.4 300233	ATE Ø 9 / 8" pneumatisch
D5 AWD	120	07/02→08/07		03/03→ 07/07; - DSTC		03.7755-4702.4 300224	ATE Ø 9 / 8" pneumatisch
				03/03→ 07/07; + DSTC		03.7858-3532.4 300233	ATE Ø 9 / 8" pneumatisch
5 T AWD	221	03/03→08/07		→ 07/07; - DSTC		03.7755-4702.4 300224	ATE Ø 9 / 8" pneumatisch
R 2	221	03/03→08/07		→ 07/07; + DSTC		03.7858-3532.4 300233	ATE Ø 9 / 8" pneumatisch
T5	191	04/04→08/07					
Pedalwegsensoren, Bremspedal							
2.0 T	132	11/99→08/07		07/01→ 12/01		03.0655-0004.2 370004	ATE
				01/02→ 07/07		03.0655-0005.2 370005	ATE
				01/05→ 07/07		03.0655-0005.2 370005	ATE
2.3	195	10/00→09/04		→ 12/01		03.0655-0004.2 370004	ATE
						03.0655-0005.2 370005	ATE
2.4	103 - 125	03/00→08/07		→ 12/01		03.0655-0004.2 370004	ATE
2.4 Bifuel	103	09/01→08/07		01/02→ 07/07		03.0655-0005.2 370005	ATE
				01/05→ 07/07		03.0655-0005.2 370005	ATE
2.4 CDI	90	07/05→12/08				03.0655-0005.2 370005	ATE
2.5 AWD	155	09/02→12/04					
2.4 D	93	04/05→12/08		05/05→ 07/07		03.0655-0005.2 370005	ATE
2.4 D	96	07/01→08/07		12/01→ 12/01		03.0655-0004.2 370004	ATE
				01/02→ 07/07		03.0655-0005.2 370005	ATE
				01/05→ 07/07		03.0655-0005.2 370005	ATE
2.4 T	147	11/99→08/03		03/00→ 12/01		03.0655-0004.2 370004	ATE
T5	184	11/99→12/04		01/02→		03.0655-0005.2 370005	ATE
2.4 T AWD	147	09/01→08/02		→ 12/01		03.0655-0004.2 370004	ATE
				01/02→		03.0655-0005.2 370005	ATE
2.5 T	154	07/01→08/07		01/05→ 07/07		03.0655-0005.2 370005	ATE
				04/04→ 07/07		03.0655-0005.2 370005	ATE
2.5 T AWD	154	07/02→08/07		01/05→ 07/07		03.0655-0005.2 370005	ATE
				09/02→ 07/07		03.0655-0005.2 370005	ATE
2.5 TDI	103	11/99→08/07		03/00→ 12/01		03.0655-0004.2 370004	ATE
				01/02→ 07/07		03.0655-0005.2 370005	ATE
				01/05→ 07/07		03.0655-0005.2 370005	ATE
D5	120	01/01→12/08		08/01→ 12/01		03.0655-0004.2 370004	ATE
				01/02→ 07/07		03.0655-0005.2 370005	ATE
				01/05→ 07/07		03.0655-0005.2 370005	ATE
D5	136	04/05→12/08		12/05→ 07/07		03.0655-0005.2 370005	ATE
D5 AWD	136	05/05→08/07					
D5 AWD	120	07/02→08/07		01/05→ 07/07		03.0655-0005.2 370005	ATE
				03/03→ 07/07		03.0655-0005.2 370005	ATE
5 T AWD	221	03/03→08/07		→ 07/07		03.0655-0005.2 370005	ATE
R 2	221	03/03→08/07		01/05→ 07/07		03.0655-0005.2 370005	ATE
T5	191	04/04→08/07					
Hauptbremszylinder							
2.0 T	132	11/99→08/07		07/01→; → 68132; - DSTC		03.2125-7637.3 010707	ATE Ø 25,4
				07/01→; → 67770; für Rechtslenker; + DSTC		03.2125-7637.3 010707	ATE Ø 25,4
				68133→; → 07/07; für Rechtslenker; - DSTC		03.2125-7638.3 010738	ATE Ø 25,4
				67771→; → 07/07; für Rechtslenker; + DSTC		03.2125-7638.3 010738	ATE Ø 25,4
				07/01→; → 70377; für Linkslenker; + DSTC		03.2125-7708.3 010739	ATE Ø 25,4
				70378→; → 07/07; für Linkslenker; + DSTC		03.2125-7713.3 010819	ATE Ø 25,4
				68133→; → 07/07; für Linkslenker; - DSTC		03.2125-7743.3 010921	ATE Ø 25,4
2.3	195	10/00→09/04		→ 68132; - DSTC		03.2125-7637.3 010707	ATE Ø 25,4
2.4 CDI	90	07/05→12/08		→ 67770; für Rechtslenker; + DSTC		03.2125-7637.3 010707	ATE Ø 25,4
2.4 T AWD	147	09/01→08/02		67771→; für Rechtslenker; + DSTC		03.2125-7638.3 010738	ATE Ø 25,4
				68133→; für Rechtslenker; - DSTC		03.2125-7638.3 010738	ATE Ø 25,4
				→ 70377; für Linkslenker; + DSTC		03.2125-7708.3 010739	ATE Ø 25,4
→							



















	kw			 	! #		
VOLVO - V70 II (285) 11/99→12/08							
Hauptbremszylinder							
2.3	195	10/00→09/04		70378→; für Linkslenker; + DSTC		03.2125-7713.3 010819	ATE Ø 25,4
2.4 CDI	90	07/05→12/08		68133→; für Linkslenker; - DSTC		03.2125-7743.3 010921	ATE Ø 25,4
2.4 T AWD	147	09/01→08/02					
2.4	103 - 125	03/00→08/07		→ 68132; - DSTC		03.2125-7637.3 010707	ATE Ø 25,4
2.4 Bifuel	103	09/01→08/07		→ 67770; für Rechtslenker; + DSTC		03.2125-7637.3 010707	ATE Ø 25,4
				68133→; → 07/07; für Rechtslenker; - DSTC		03.2125-7638.3 010738	ATE Ø 25,4
				67771→; → 07/07; für Rechtslenker; + DSTC		03.2125-7638.3 010738	ATE Ø 25,4
				→ 70377; für Linkslenker; + DSTC		03.2125-7708.3 010739	ATE Ø 25,4
				70378→; → 07/07; für Linkslenker; + DSTC		03.2125-7713.3 010819	ATE Ø 25,4
				68133→; → 07/07; für Linkslenker; - DSTC		03.2125-7743.3 010921	ATE Ø 25,4
2.4 D	93	04/05→12/08		05/05→ 07/07; für Rechtslenker		03.2125-7638.3 010738	ATE Ø 25,4
				05/05→ 07/07; für Linkslenker; + DSTC		03.2125-7713.3 010819	ATE Ø 25,4
				05/05→ 07/07; für Linkslenker; - DSTC		03.2125-7743.3 010921	ATE Ø 25,4
2.4 D	96	07/01→08/07		12/01→; → 68132; - DSTC		03.2125-7637.3 010707	ATE Ø 25,4
				12/01→; → 67770; für Rechtslenker; + DSTC		03.2125-7637.3 010707	ATE Ø 25,4
				68133→; → 07/07; für Rechtslenker; - DSTC		03.2125-7638.3 010738	ATE Ø 25,4
				67771→; → 07/07; für Rechtslenker; + DSTC		03.2125-7638.3 010738	ATE Ø 25,4
				12/01→; → 70377; für Linkslenker; + DSTC		03.2125-7708.3 010739	ATE Ø 25,4
				70378→; → 07/07; für Linkslenker; + DSTC		03.2125-7713.3 010819	ATE Ø 25,4
				68133→; → 07/07; für Linkslenker; - DSTC		03.2125-7743.3 010921	ATE Ø 25,4
2.4 T	147	11/99→08/03		03/00→; → 67770; für Rechtslenker; + DSTC		03.2125-7637.3 010707	ATE Ø 25,4
T5	184	11/99→12/04		03/00→; → 68132; - DSTC		03.2125-7637.3 010707	ATE Ø 25,4
				68133→; für Rechtslenker; - DSTC		03.2125-7638.3 010738	ATE Ø 25,4
				67771→; für Rechtslenker; + DSTC		03.2125-7638.3 010738	ATE Ø 25,4
				03/00→; → 70377; für Linkslenker; + DSTC		03.2125-7708.3 010739	ATE Ø 25,4
				70378→; für Linkslenker; + DSTC		03.2125-7713.3 010819	ATE Ø 25,4
				68133→; für Linkslenker; - DSTC		03.2125-7743.3 010921	ATE Ø 25,4
2.5 AWD	155	09/02→12/04		für Rechtslenker		03.2125-7638.3 010738	ATE Ø 25,4
				für Linkslenker; + DSTC		03.2125-7713.3 010819	ATE Ø 25,4
				für Linkslenker; - DSTC		03.2125-7743.3 010921	ATE Ø 25,4
2.5 T	154	07/01→08/07		04/04→ 07/07; für Rechtslenker		03.2125-7638.3 010738	ATE Ø 25,4
				04/04→ 07/07; für Linkslenker; + DSTC		03.2125-7713.3 010819	ATE Ø 25,4
				04/04→ 07/07; für Linkslenker; - DSTC		03.2125-7743.3 010921	ATE Ø 25,4
2.5 T AWD	154	07/02→08/07		09/02→ 07/07; für Rechtslenker		03.2125-7638.3 010738	ATE Ø 25,4
				09/02→ 07/07; für Linkslenker; + DSTC		03.2125-7713.3 010819	ATE Ø 25,4
				09/02→ 07/07; für Linkslenker; - DSTC		03.2125-7743.3 010921	ATE Ø 25,4
2.5 TDI	103	11/99→08/07		03/00→; → 68132; - DSTC		03.2125-7637.3 010707	ATE Ø 25,4
				03/00→; → 67770; für Rechtslenker; + DSTC		03.2125-7637.3 010707	ATE Ø 25,4
				68133→; → 07/07; für Rechtslenker; - DSTC		03.2125-7638.3 010738	ATE Ø 25,4
				67771→; → 07/07; für Rechtslenker; + DSTC		03.2125-7638.3 010738	ATE Ø 25,4
				03/00→; → 70377; für Linkslenker; + DSTC		03.2125-7708.3 010739	ATE Ø 25,4
				70378→; → 07/07; für Linkslenker; + DSTC		03.2125-7713.3 010819	ATE Ø 25,4
				68133→; → 07/07; für Linkslenker; - DSTC		03.2125-7743.3 010921	ATE Ø 25,4
D5	120	01/01→12/08		08/01→; → 68132; - DSTC		03.2125-7637.3 010707	ATE Ø 25,4
				08/01→; → 67770; für Rechtslenker; + DSTC		03.2125-7637.3 010707	ATE Ø 25,4
				68133→; → 07/07; für Rechtslenker; - DSTC		03.2125-7638.3 010738	ATE Ø 25,4
				67771→; → 07/07; für Rechtslenker; + DSTC		03.2125-7638.3 010738	ATE Ø 25,4
→							













	kw			 	! #		
VOLVO - V70 II (285) 11/99→12/08							
 Hauptbremszylinder							
D5	120	01/01→12/08		08/01→; → 70377; für Linkslenker; + DSTC	03.2125-7708.3	010739	ATE Ø 25,4
				70378→; → 07/07; für Linkslenker; + DSTC	03.2125-7713.3	010819	ATE Ø 25,4
				68133→; → 07/07; für Linkslenker; - DSTC	03.2125-7743.3	010921	ATE Ø 25,4
D5	136	04/05→12/08		12/05→ 07/07; für Rechtslenker	03.2125-7638.3	010738	ATE Ø 25,4
D5 AWD	136	05/05→08/07		12/05→ 07/07; für Linkslenker; + DSTC	03.2125-7713.3	010819	ATE Ø 25,4
				12/05→ 07/07; für Linkslenker; - DSTC	03.2125-7743.3	010921	ATE Ø 25,4
D5 AWD	120	07/02→08/07		03/03→ 07/07; für Rechtslenker; + DSTC	03.2125-7638.3	010738	ATE Ø 25,4
				68133→; → 07/07; für Rechtslenker; - DSTC	03.2125-7638.3	010738	ATE Ø 25,4
				03/03→ 07/07; für Linkslenker; + DSTC	03.2125-7713.3	010819	ATE Ø 25,4
				03/03→ 07/07; für Linkslenker; - DSTC	03.2125-7743.3	010921	ATE Ø 25,4
5 T AWD	221	03/03→08/07		→ 07/07; für Rechtslenker; + DSTC	03.2125-7638.3	010738	ATE Ø 25,4
R 2	221	03/03→08/07		→ 07/07; für Linkslenker; + DSTC	03.2125-7713.3	010819	ATE Ø 25,4
				→ 07/07; für Linkslenker; - DSTC	03.2125-7743.3	010921	ATE Ø 25,4
T5	191	04/04→08/07		→ 07/07; für Rechtslenker	03.2125-7638.3	010738	ATE Ø 25,4
				→ 07/07; für Linkslenker; + DSTC	03.2125-7713.3	010819	ATE Ø 25,4
				→ 07/07; für Linkslenker; - DSTC	03.2125-7743.3	010921	ATE Ø 25,4
VOLVO - V70 III (135) 04/07→04/16							
 Bremskraftverstärker							
1.6 D	80	07/09→12/11		01/10→; für Linkslenker; für Fahrzeuge ohne Kollisionswarner	03.7755-9703.4	300239	ATE Ø 9 / 8" pneumatisch
2.0 T	149	09/09→12/11					
1.6 DRiVe / D2	84	04/11→12/15		für Linkslenker; für Fahrzeuge ohne Kollisionswarner	03.7755-9703.4	300239	ATE Ø 9 / 8" pneumatisch
2.0	107	10/07→12/11					
2.0 D	100	10/07→12/15					
2.0 FlexiFuel	107	01/08→12/11					
T5	177	01/10→12/14					
2.0 BiFuel	157	03/13→12/15		→ 213000; für Fahrzeuge ohne Kollisionswarner	03.7755-9703.4	300239	ATE Ø 9 / 8" pneumatisch
2.5 T	147	08/07→12/09					
2.5 T FlexiFuel	147	05/08→12/09					
3.2	175 - 179	08/07→12/14		→ 213000; für Fahrzeuge mit Kollisionswarner	03.7858-5032.4	300275	ATE Ø 9 / 8" pneumatisch
3.2 AWD	179	04/10→12/15					
D3	100	10/07→12/15					
D3 / D4	120	03/10→12/15					
D5	158 - 169	03/11→04/16					
D5 AWD	151 - 169	12/09→04/16					
T4	132	10/10→12/15					
T4F	132	01/11→12/15					
T6 AWD	210 - 242	08/07→04/16					
2.4 D	120	04/07→12/10		08/07→; → 213000; für Fahrzeuge ohne Kollisionswarner	03.7755-9703.4	300239	ATE Ø 9 / 8" pneumatisch
3.2 AWD	175	04/07→12/10					
D5	136	04/07→12/09		08/07→; → 213000; für Fahrzeuge mit Kollisionswarner	03.7858-5032.4	300275	ATE Ø 9 / 8" pneumatisch
2.4 D	129	04/09→12/10		10/09→; → 213000; für Fahrzeuge ohne Kollisionswarner	03.7755-9703.4	300239	ATE Ø 9 / 8" pneumatisch
2.5 T	170	04/09→12/12					
2.5 T FlexiFuel	170	04/09→12/11		10/09→; → 213000; für Fahrzeuge mit Kollisionswarner	03.7858-5032.4	300275	ATE Ø 9 / 8" pneumatisch
D4	133	10/13→04/16		für Fahrzeuge ohne Kollisionswarner	03.7755-9703.4	300239	ATE Ø 9 / 8" pneumatisch
D4 AWD	133	10/13→04/16					
D5	151	10/08→12/11		12/09→; → 213000; für Fahrzeuge ohne Kollisionswarner	03.7755-9703.4	300239	ATE Ø 9 / 8" pneumatisch
				12/09→; → 213000; für Fahrzeuge mit Kollisionswarner	03.7858-5032.4	300275	ATE Ø 9 / 8" pneumatisch
D5 AWD	136	04/07→12/09		10/07→; → 213000; für Fahrzeuge ohne Kollisionswarner	03.7755-9703.4	300239	ATE Ø 9 / 8" pneumatisch
				10/07→; → 213000; für Fahrzeuge mit Kollisionswarner	03.7858-5032.4	300275	ATE Ø 9 / 8" pneumatisch
D5 AWD	158	04/11→12/15		06/11→; → 213000; für Fahrzeuge ohne Kollisionswarner	03.7755-9703.4	300239	ATE Ø 9 / 8" pneumatisch
				06/11→; → 213000; für Fahrzeuge mit Kollisionswarner	03.7858-5032.4	300275	ATE Ø 9 / 8" pneumatisch
T5	180	10/13→04/16		für Fahrzeuge ohne Kollisionswarner	03.7755-9703.4	300239	ATE Ø 9 / 8" pneumatisch
→				für Fahrzeuge mit Kollisionswarner	03.7858-5032.4	300275	ATE Ø 9 / 8" pneumatisch







	kw			 	! #		
VOLVO - V70 III (135) 04/07→04/16							
Pedalwegsensoren, Bremspedal							
1.6 D 2.0 T	80 149	07/09→12/11 09/09→12/11		01/10→; für Fahrzeuge mit Kollisionswarner		03.0655-0007.2 370007	ATE
1.6 DRIVE / D2 2.0 2.0 D 2.0 FlexiFuel D4 D4 AWD T5	84 107 100 107 133 120 - 133 177 - 180	04/11→12/15 10/07→12/11 10/07→12/15 01/08→12/11 10/13→04/16 10/07→04/16 01/10→04/16		für Fahrzeuge mit Kollisionswarner		03.0655-0007.2 370007	ATE
2.0 BiFuel	157	03/13→12/15		für Fahrzeuge mit Kollisionswarner		03.0655-0007.2 370007	ATE
				→ 213000; für Fahrzeuge mit Kollisionswarner		03.0655-0007.2 370007	ATE
2.0 GDI	157	04/12→12/15		03/13→; für Fahrzeuge mit Kollisionswarner		03.0655-0007.2 370007	ATE
2.4 D 3.2 AWD D5	120 175 136	04/07→12/10 04/07→12/10 04/07→12/09		08/07→; → 213000; für Fahrzeuge mit Kollisionswarner		03.0655-0007.2 370007	ATE
				213001→; für Fahrzeuge mit Kollisionswarner		03.0655-0007.2 370007	ATE
2.4 D 2.5 T 2.5 T FlexiFuel	129 170 170	04/09→12/10 04/09→12/12 04/09→12/11		10/09→; → 213000; für Fahrzeuge mit Kollisionswarner		03.0655-0007.2 370007	ATE
				213001→; für Fahrzeuge mit Kollisionswarner		03.0655-0007.2 370007	ATE
2.5 T 2.5 T FlexiFuel 3.2	147 147 175 - 179	08/07→12/09 05/08→12/09 08/07→12/14		→ 213000; für Fahrzeuge mit Kollisionswarner		03.0655-0007.2 370007	ATE
				213001→; für Fahrzeuge mit Kollisionswarner		03.0655-0007.2 370007	ATE
3.2 AWD D3 D3 / D4 D5 D5 AWD	179 100 120 158 - 169 151 - 169	04/10→12/15 10/07→12/15 03/10→12/15 03/11→04/16 12/09→04/16					
T4 T4F T6 AWD	132 132 210 - 242	10/10→12/15 01/11→12/15 08/07→04/16					
D5	151	10/08→12/11		12/09→; → 213000; für Fahrzeuge mit Kollisionswarner		03.0655-0007.2 370007	ATE
				213001→; für Fahrzeuge mit Kollisionswarner		03.0655-0007.2 370007	ATE
D5 AWD	136	04/07→12/09		10/07→; → 213000; für Fahrzeuge mit Kollisionswarner		03.0655-0007.2 370007	ATE
				213001→; für Fahrzeuge mit Kollisionswarner		03.0655-0007.2 370007	ATE
D5 AWD	158	04/11→12/15		06/11→; → 213000; für Fahrzeuge mit Kollisionswarner		03.0655-0007.2 370007	ATE
				213001→; für Fahrzeuge mit Kollisionswarner		03.0655-0007.2 370007	ATE
Hauptbremszylinder							
D5 D5 AWD T6 AWD	169 169 224 - 242	03/11→04/16 03/11→04/16 01/10→04/16				24.4156-1391.3 011054	ATE Ø 27 ohne Bremsflüssigkeitsbehälter
VOLVO - V70 III Kasten/Kombi (135) 09/13→12/15							
Bremskraftverstärker							
2.0 D3 DRIVE 2.4 D5	100 158	09/13→12/15 09/13→12/15		→ 213000; für Fahrzeuge ohne Kollisionswarner		03.7755-9703.4 300239	ATE Ø 9 / 8" pneumatisch
				→ 213000; für Fahrzeuge mit Kollisionswarner		03.7858-5032.4 300275	ATE Ø 9 / 8" pneumatisch
Pedalwegsensoren, Bremspedal							
2.0 D3 DRIVE 2.4 D5	100 158	09/13→12/15 09/13→12/15		→ 213000; für Fahrzeuge mit Kollisionswarner		03.0655-0007.2 370007	ATE
				213001→; für Fahrzeuge mit Kollisionswarner		03.0655-0007.2 370007	ATE
2.4 D4 AWD	120	09/13→12/15		für Fahrzeuge mit Kollisionswarner		03.0655-0007.2 370007	ATE
VOLVO - XC60 I SUV (156) 05/08→12/17							
Bremskraftverstärker							
2.4 D 3.2 AWD →	129 175	04/09→12/10 07/09→12/10		für Fahrzeuge ohne Kollisionswarner		03.7755-0132.4 300265	ATE Ø 9 / 8" pneumatisch











	kw			 	! #		
VOLVO - XC60 I SUV (156) 05/08→12/17							
Bremskraftverstärker							
D3 / D4 D5 D5 AWD	120 158 151	03/10→12/14 06/11→02/17 07/09→06/11		für Fahrzeuge mit Kollisionswarner		03.7858-5132.4 300276	ATE Ø 9 / 8" pneumatisch
2.4 D / D3 / D4 AWD D5 AWD T6 AWD	120 136 210	05/08→02/17 05/08→12/09 05/08→12/10		09/08→; für Fahrzeuge ohne Kollisionswarner		03.7755-0132.4 300265	ATE Ø 9 / 8" pneumatisch
				09/08→; für Fahrzeuge mit Kollisionswarner		03.7858-5132.4 300276	ATE Ø 9 / 8" pneumatisch
3.2 3.2 AWD D5 AWD T6 AWD	171 - 179 179 169 224	09/11→12/14 03/10→12/15 04/14→12/15 03/10→02/17		→ 236999; für Fahrzeuge ohne Kollisionswarner		03.7755-0132.4 300265	ATE Ø 9 / 8" pneumatisch
				→ 236999; für Fahrzeuge mit Kollisionswarner		03.7858-5132.4 300276	ATE Ø 9 / 8" pneumatisch
D3 D4	110 133 - 140	03/15→04/17 10/13→02/17		für Fahrzeuge ohne Kollisionswarner		03.7755-0132.4 300265	ATE Ø 9 / 8" pneumatisch
D4 AWD D5 AWD T6 AWD	133 - 140 162 242	10/13→02/17 03/15→02/17 04/14→12/15		→ 236999; für Fahrzeuge ohne Kollisionswarner		03.7755-0132.4 300265	ATE Ø 9 / 8" pneumatisch
				237000→; für Fahrzeuge ohne Kollisionswarner		03.7755-0132.4 300265	ATE Ø 9 / 8" pneumatisch
				→ 236999; für Fahrzeuge mit Kollisionswarner		03.7858-5132.4 300276	ATE Ø 9 / 8" pneumatisch
D5 AWD	158	04/11→12/15		06/11→; → 236999; für Fahrzeuge ohne Kollisionswarner		03.7755-0132.4 300265	ATE Ø 9 / 8" pneumatisch
				06/11→; → 236999; für Fahrzeuge mit Kollisionswarner		03.7858-5132.4 300276	ATE Ø 9 / 8" pneumatisch
T5 T5 AWD T6 T6 AWD	180 180 225 225	10/13→02/17 10/15→02/17 10/13→02/17 10/13→12/17		für Fahrzeuge ohne Kollisionswarner		03.7755-9703.4 300239	ATE Ø 9 / 8" pneumatisch
Pedalwegsensor, Bremspedal							
2.0 T	149	12/09→12/12		03/10→; für Fahrzeuge mit Kollisionswarner		03.0655-0007.2 370007	ATE
2.4 D 3.2 AWD D3 D3 / D4 D4 D5 D5 AWD T5 T5 AWD T6 T6 AWD	129 175 110 120 133 - 140 158 151 177 - 180 180 - 187 225 225	04/09→12/10 07/09→12/10 03/15→04/17 03/10→12/14 10/13→02/17 06/11→02/17 07/09→06/11 09/10→02/17 04/14→02/17 10/13→02/17 10/13→12/17		für Fahrzeuge mit Kollisionswarner		03.0655-0007.2 370007	ATE
2.4 D / D3 / D4 AWD D5 AWD T6 AWD	120 136 210	05/08→02/17 05/08→12/09 05/08→12/10		09/08→; für Fahrzeuge mit Kollisionswarner		03.0655-0007.2 370007	ATE
3.2 3.2 AWD D4 AWD D5 AWD T6 AWD	171 - 179 179 133 - 140 162 - 169 224 - 242	09/11→12/14 03/10→12/15 10/13→02/17 04/14→02/17 03/10→02/17		→ 236999; für Fahrzeuge mit Kollisionswarner		03.0655-0007.2 370007	ATE
				237000→; für Fahrzeuge mit Kollisionswarner		03.0655-0007.2 370007	ATE
D5 AWD	158	04/11→12/15		06/11→; → 236999; für Fahrzeuge mit Kollisionswarner		03.0655-0007.2 370007	ATE
				237000→; für Fahrzeuge mit Kollisionswarner		03.0655-0007.2 370007	ATE
VOLVO - XC60 I VAN (156) 05/08→12/17							
Bremskraftverstärker							
D4 D4 AWD D5 AWD	120 120 158	09/13→02/17 09/13→02/17 09/13→02/17		für Fahrzeuge ohne Kollisionswarner		03.7755-0132.4 300265	ATE Ø 9 / 8" pneumatisch
				für Fahrzeuge mit Kollisionswarner		03.7858-5132.4 300276	ATE Ø 9 / 8" pneumatisch
Pedalwegsensor, Bremspedal							
D4 D4 AWD D5 AWD	120 120 158	09/13→02/17 09/13→02/17 09/13→02/17		für Fahrzeuge mit Kollisionswarner		03.0655-0007.2 370007	ATE

	kw					! #		
VOLVO - XC70 I Cross Country (295) 10/97→10/07								
Bremskraftverstärker								
2.4 T XC AWD	142 - 147	11/97→09/02		→ 12/01; - DSTC		03.7755-3402.4	300189	ATE Ø 9 / 8" pneumatisch
				01/02→; - DSTC		03.7755-4702.4	300224	ATE Ø 9 / 8" pneumatisch
				+ DSTC		03.7858-3532.4	300233	ATE Ø 9 / 8" pneumatisch
2.5 T XC AWD	154	09/02→08/07		→ 07/07; - DSTC		03.7755-4702.4	300224	ATE Ø 9 / 8" pneumatisch
D5 AWD	136	12/05→08/07						
D5 XC AWD	120	09/02→08/07		→ 07/07; + DSTC		03.7858-3532.4	300233	ATE Ø 9 / 8" pneumatisch
Pedalwegsensord, Bremspedal								
2.4 T XC AWD	142 - 147	11/97→09/02		→ 12/01		03.0655-0004.2	370004	ATE
						03.0655-0005.2	370005	ATE
				01/02→		03.0655-0005.2	370005	ATE
2.5 T XC AWD	154	09/02→08/07		→ 07/07		03.0655-0005.2	370005	ATE
D5 AWD	136	12/05→08/07						
D5 XC AWD	120	09/02→08/07						
Hauptbremszylinder								
2.4 T XC AWD	142 - 147	11/97→09/02		11001→; für Rechtslenker; - DSTC		03.2125-7637.3	010707	ATE Ø 25,4
				→ 69018; für Rechtslenker; + DSTC		03.2125-7637.3	010707	ATE Ø 25,4
				→ 11000; für Linkslenker; - DSTC		03.2125-7637.3	010707	ATE Ø 25,4
				69019→; für Rechtslenker; + DSTC		03.2125-7638.3	010738	ATE Ø 25,4
				→ 11000; für Rechtslenker; - DSTC		03.2125-7638.3	010738	ATE Ø 25,4
				→ 66913; für Linkslenker; + DSTC		03.2125-7708.3	010739	ATE Ø 25,4
				66914→; für Linkslenker; + DSTC		03.2125-7713.3	010819	ATE Ø 25,4
				11001→; für Linkslenker; - DSTC		03.2125-7743.3	010921	ATE Ø 25,4
2.5 T XC AWD	154	09/02→08/07		→ 07/07; für Rechtslenker; - DSTC		03.2125-7637.3	010707	ATE Ø 25,4
D5 XC AWD	120	09/02→08/07		→ 07/07; für Rechtslenker; + DSTC		03.2125-7638.3	010738	ATE Ø 25,4
				→ 07/07; für Linkslenker; + DSTC		03.2125-7713.3	010819	ATE Ø 25,4
				→ 07/07; für Linkslenker; - DSTC		03.2125-7743.3	010921	ATE Ø 25,4
D5 AWD	136	12/05→08/07		→ 07/07; für Rechtslenker; - DSTC		03.2125-7637.3	010707	ATE Ø 25,4
				→ 07/07; für Linkslenker; + DSTC		03.2125-7713.3	010819	ATE Ø 25,4
				→ 07/07; für Linkslenker; - DSTC		03.2125-7743.3	010921	ATE Ø 25,4
VOLVO - XC70 II (136) 04/07→12/16								
Bremskraftverstärker								
2.4 D	129	06/09→12/10		01/10→; für Fahrzeuge ohne Kollisionswarner		03.7755-0132.4	300265	ATE Ø 9 / 8" pneumatisch
						03.7755-9703.4	300239	ATE Ø 9 / 8" pneumatisch
				01/10→; für Fahrzeuge mit Kollisionswarner		03.7858-5032.4	300275	ATE Ø 9 / 8" pneumatisch
						03.7858-5132.4	300276	ATE Ø 9 / 8" pneumatisch
2.4 D / D4 AWD	120	08/07→04/16		für Fahrzeuge ohne Kollisionswarner		03.7755-0132.4	300265	ATE Ø 9 / 8" pneumatisch
3.2 AWD	175 - 179	08/07→12/14				03.7755-9703.4	300239	ATE Ø 9 / 8" pneumatisch
D3	120	04/10→12/15		für Fahrzeuge mit Kollisionswarner		03.7858-5032.4	300275	ATE Ø 9 / 8" pneumatisch
D5 AWD	158 - 169	04/11→04/16				03.7858-5132.4	300276	ATE Ø 9 / 8" pneumatisch
T5	180	10/13→12/16						
T6 AWD	210 - 224	01/08→12/16						
T6 Polestar AWD	242	11/13→12/16						
D4	133	10/13→04/16		für Fahrzeuge ohne Kollisionswarner		03.7755-9703.4	300239	ATE Ø 9 / 8" pneumatisch
D4 AWD	133	10/13→04/16						
T5 AWD	187	08/15→12/16						
T6 AWD	183	03/15→12/16						
D5 AWD	136	04/07→12/09		08/07→; für Fahrzeuge ohne Kollisionswarner		03.7755-0132.4	300265	ATE Ø 9 / 8" pneumatisch
						03.7755-9703.4	300239	ATE Ø 9 / 8" pneumatisch
				08/07→; für Fahrzeuge mit Kollisionswarner		03.7858-5032.4	300275	ATE Ø 9 / 8" pneumatisch
						03.7858-5132.4	300276	ATE Ø 9 / 8" pneumatisch
D5 AWD	151	04/09→12/11		12/09→; für Fahrzeuge ohne Kollisionswarner		03.7755-0132.4	300265	ATE Ø 9 / 8" pneumatisch
						03.7755-9703.4	300239	ATE Ø 9 / 8" pneumatisch
				12/09→; für Fahrzeuge mit Kollisionswarner		03.7858-5032.4	300275	ATE Ø 9 / 8" pneumatisch
						03.7858-5132.4	300276	ATE Ø 9 / 8" pneumatisch
Pedalwegsensord, Bremspedal								
2.4 D	129	06/09→12/10		01/10→; für Fahrzeuge mit Kollisionswarner		03.0655-0007.2	370007	ATE
2.4 D / D4 AWD	120	08/07→04/16		für Fahrzeuge mit Kollisionswarner		03.0655-0007.2	370007	ATE
3.2 AWD	175 - 179	08/07→12/14						
D3	120	04/10→12/15						
→								

	kw					! #		
VOLVO - XC70 II (136) 04/07→12/16								
Pedalwegsensord, Bremspedal								
D5 AWD	158 - 169	04/11→04/16		für Fahrzeuge mit Kollisionswarner		03.0655-0007.2	370007	ATE
T5	180	10/13→12/16						
T6 AWD	210 - 224	01/08→12/16						
T6 Polestar AWD	242	11/13→12/16						
D5 AWD	136	04/07→12/09		08/07→; für Fahrzeuge mit Kollisionswarner		03.0655-0007.2	370007	ATE
D5 AWD	151	04/09→12/11		12/09→; für Fahrzeuge mit Kollisionswarner		03.0655-0007.2	370007	ATE
VOLVO - XC70 II VAN (136) 04/07→12/16								
 Bremskraftverstärker								
2.0 D4	120	09/13→12/16		für Fahrzeuge ohne Kollisionswarner		03.7755-0132.4	300265	ATE Ø 9 / 8" pneumatisch
2.4 D4 AWD	120	09/13→04/16				03.7755-9703.4	300239	ATE Ø 9 / 8" pneumatisch
2.4 D5 AWD	158	09/13→12/16		für Fahrzeuge mit Kollisionswarner		03.7858-5032.4	300275	ATE Ø 9 / 8" pneumatisch
						03.7858-5132.4	300276	ATE Ø 9 / 8" pneumatisch
Pedalwegsensord, Bremspedal								
2.0 D4	120	09/13→12/16		für Fahrzeuge mit Kollisionswarner		03.0655-0007.2	370007	ATE
2.4 D4 AWD	120	09/13→04/16						
2.4 D5 AWD	158	09/13→12/16						
VOLVO - XC90 I (275) 06/02→01/15								
 Bremskraftverstärker								
2.5	153	01/03→12/06		für Linkslenker; Felgengröße [Zoll]: 18		03.7858-3032.4	300257	ATE Ø 9 / 8" pneumatisch
2.5 AWD	153	06/02→12/14						
2.5 T AWD	154	10/02→09/14		für Linkslenker		03.7858-3632.4	300234	ATE Ø 9 / 8" pneumatisch
D3 / D5	120	04/09→12/14						
D5 AWD	120 - 136	10/02→12/10						
T6 AWD	200	10/02→12/06						
V8 AWD	232 - 235	09/04→12/10						
3.2	175 - 179	09/11→09/14		für Linkslenker		03.7858-3632.4	300234	ATE Ø 9 / 8" pneumatisch
3.2 AWD	179	04/10→09/14						
D5 AWD	147 - 155	01/11→12/14						
3.2 AWD	175	03/06→12/10		05/06→; für Linkslenker; Felgengröße [Zoll]: 18		03.7858-3032.4	300257	ATE Ø 9 / 8" pneumatisch
				05/06→; für Linkslenker		03.7858-3632.4	300234	ATE Ø 9 / 8" pneumatisch
Pedalwegsensord, Bremspedal								
2.5	153	01/03→12/06				03.0655-0005.2	370005	ATE
2.5 AWD	153	06/02→12/14						
2.5 T AWD	154	10/02→09/14						
3.2	175 - 179	09/11→09/14						
3.2 AWD	179	04/10→09/14						
D3 / D5	120	04/09→12/14						
D5 AWD	120 - 155	10/02→12/14						
T6 AWD	200	10/02→12/06						
V8 AWD	232 - 235	09/04→12/10						
3.2 AWD	175	03/06→12/10		05/06→		03.0655-0005.2	370005	ATE
D5 AWD	136	04/05→12/10						
 Hauptbremszylinder								
2.5	153	01/03→12/06		für Rechtslenker		03.2125-7638.3	010738	ATE Ø 25,4
2.5 AWD	153	06/02→12/14						
2.5 T AWD	154	10/02→09/14		für Linkslenker		03.2125-7713.3	010819	ATE Ø 25,4
D3 / D5	120	04/09→12/14						
D5 AWD	120 - 155	10/02→12/14						
3.2	175 - 179	09/11→09/14		für Linkslenker		03.2125-7713.3	010819	ATE Ø 25,4
3.2 AWD	179	04/10→09/14						
T6 AWD	200	10/02→12/06						
V8 AWD	232 - 235	09/04→12/10						
3.2 AWD	175	03/06→12/10		05/06→; für Linkslenker		03.2125-7713.3	010819	ATE Ø 25,4
D5 AWD	136	04/05→12/10		05/06→; für Rechtslenker		03.2125-7638.3	010738	ATE Ø 25,4
				05/06→; für Linkslenker		03.2125-7713.3	010819	ATE Ø 25,4

	kW			 	! #		
VOLVO - XC90 I VAN (275) 06/02→01/15							
 Bremskraftverstärker							
2.4 D4	120	09/13→12/14		für Linkslenker; Felgenreöße [Zoll]: 18	03.7858-3032.4	300257	ATE Ø 9 / 8" pneumatisch
				für Linkslenker	03.7858-3632.4	300234	ATE Ø 9 / 8" pneumatisch
2.4 D5 AWD	147	09/13→12/14		für Linkslenker	03.7858-3632.4	300234	ATE Ø 9 / 8" pneumatisch
Pedalwegsensoren, Bremspedal							
2.4 D4	120	09/13→12/14			03.0655-0005.2	370005	ATE
2.4 D5 AWD	147	09/13→12/14					
 Hauptbremszylinder							
2.4 D4	120	09/13→12/14		für Rechtslenker	03.2125-7638.3	010738	ATE Ø 25,4
2.4 D5 AWD	147	09/13→12/14		für Linkslenker	03.2125-7713.3	010819	ATE Ø 25,4
VW - AMAROK (2HA, 2HB, S1B, S6B, S7A, S7B) 09/10→							
 Hauptbremszylinder							
2.0 BiTDI	120 - 132	09/10→05/22			03.2126-5132.3	011012	ATE Ø 27
2.0 BiTDI 4motion	120 - 132	09/10→05/22			24.2126-3131.3	011038	ATE Ø 27 ohne Bremsflüssigkeitsbehälter
2.0 TDI	90 - 103	09/10→05/22					
2.0 TDI 4motion	90 - 103	09/10→05/22					
2.0 TSI	118	12/10→10/16					
3.0 TDI	120	06/16→08/19					
3.0 TDI 4motion	150 - 190	06/16→05/22					
3.0 TDI 4motion	120 - 165	06/16→05/22		09/16→	03.2126-5132.3	011012	ATE Ø 27
					24.2126-3131.3	011038	ATE Ø 27 ohne Bremsflüssigkeitsbehälter
VW - AMAROK Pritsche/Fahrgestell (S1B, S6B, S7B) 09/11→05/22							
 Hauptbremszylinder							
2.0 BiTDI	132	09/11→07/19		11/11→	03.2126-5132.3	011012	ATE Ø 27
					24.2126-3131.3	011038	ATE Ø 27 ohne Bremsflüssigkeitsbehälter
2.0 BiTDI 4motion	132	09/11→07/19		11/11→	03.2126-5132.3	011012	ATE Ø 27
					24.2126-3131.3	011038	ATE Ø 27 ohne Bremsflüssigkeitsbehälter
2.0 TDI	90 - 103	09/11→10/16		07/12→	03.2126-5132.3	011012	ATE Ø 27
					24.2126-3131.3	011038	ATE Ø 27 ohne Bremsflüssigkeitsbehälter
2.0 TDI 4motion	103	09/11→10/16		06/12→	03.2126-5132.3	011012	ATE Ø 27
					24.2126-3131.3	011038	ATE Ø 27 ohne Bremsflüssigkeitsbehälter
3.0 TDI 4motion	150 - 190	06/16→05/22			03.2126-5132.3	011012	ATE Ø 27
					24.2126-3131.3	011038	ATE Ø 27 ohne Bremsflüssigkeitsbehälter
VW - ARTEON (3H7, 3H8) 03/17→							
 Hauptbremszylinder							
1.5 TSI	110	11/17→07/19		für Linkslenker; Herstellereinschränkung	24.4153-1522.3	011048	ATE Ø 23,8 ohne Bremsflüssigkeitsbehälter
2.0 TDI	110 - 147	03/17→		ATE			
2.0 TDI 4motion	140 - 176	03/17→					
2.0 TSI	140	05/17→					
2.0 TSI 4motion	200 - 206	04/17→					
VW - ARTEON SHOOTING BRAKE (3H9) 06/20→							
 Hauptbremszylinder							
1.5 TSi	110	08/20→		für Linkslenker; Herstellereinschränkung	24.4153-1522.3	011048	ATE Ø 23,8 ohne Bremsflüssigkeitsbehälter
2.0 TDI	110 - 147	09/20→		ATE			
2.0 TDI 4motion	140 - 147	09/20→					
2.0 TSi	140	09/20→					
2.0 TSi 4motion	200	06/20→					
2.0 TSi 4motion	206	06/20→					

	kw				! #		
VW - BEETLE (5C1, 5C2) 04/11→07/19							
 Hauptbremszylinder							
1.2 TSI 1.2 TSI 16V 1.6 TDI	77	07/11→07/19 12/14→07/19 10/11→07/16		für Rechtslenker		24.4152-0132.3 011025	ATE Ø 22,2 ohne Bremsflüssigkeitsbehälter
1.4 TSI 2.0 TSI	110	12/14→07/19 130 - 12/14→07/19 162		für Rechtslenker		24.4153-0202.3 011027	ATE Ø 23,8 ohne Bremsflüssigkeitsbehälter
1.4 TSI	118	10/11→07/16		für Rechtslenker; +PR 1ZP		24.4152-0132.3 011025	ATE Ø 22,2 ohne Bremsflüssigkeitsbehälter
				für Rechtslenker; +PR 1ZA		24.4153-0202.3 011027	ATE Ø 23,8 ohne Bremsflüssigkeitsbehälter
2.0 TDI	81	06/14→09/18		12/14→; für Rechtslenker		24.4153-0202.3 011027	ATE Ø 23,8 ohne Bremsflüssigkeitsbehälter
2.0 TDI	103	04/11→07/16		für Rechtslenker; +PR 1ZP		24.4152-0132.3 011025	ATE Ø 22,2 ohne Bremsflüssigkeitsbehälter
2.0 TDI	110	07/14→09/18		09/14→; +PR 1ZP; für Rechtslenker		24.4152-0132.3 011025	ATE Ø 22,2 ohne Bremsflüssigkeitsbehälter
2.0 TFSI	147	04/11→07/16		für Rechtslenker; +PR 1LV		24.4152-0132.3 011025	ATE Ø 22,2 ohne Bremsflüssigkeitsbehälter
				für Rechtslenker; +PR 1ZA / 1ZB		24.4153-0202.3 011027	ATE Ø 23,8 ohne Bremsflüssigkeitsbehälter
2.0 TSI	155	12/12→07/19		05/13→; für Rechtslenker; +PR 1LV		24.4152-0132.3 011025	ATE Ø 22,2 ohne Bremsflüssigkeitsbehälter
				05/13→; für Rechtslenker; +PR 1ZA / 1ZB		24.4153-0202.3 011027	ATE Ø 23,8 ohne Bremsflüssigkeitsbehälter
VW - BEETLE Cabriolet (5C7, 5C8) 12/11→07/19							
 Hauptbremszylinder							
1.2 TSI 1.6 TDI	77	12/11→07/19 12/11→07/16		11/12→; für Rechtslenker		24.4152-0132.3 011025	ATE Ø 22,2 ohne Bremsflüssigkeitsbehälter
1.2 TSI 16V	77	12/14→07/19		für Rechtslenker		24.4152-0132.3 011025	ATE Ø 22,2 ohne Bremsflüssigkeitsbehälter
1.4 TSI 2.0 TSI	110	12/14→09/18 162 12/14→09/18		für Rechtslenker		24.4153-0202.3 011027	ATE Ø 23,8 ohne Bremsflüssigkeitsbehälter
1.4 TSI	118	12/11→07/16		11/12→; für Rechtslenker; +PR 1ZP		24.4152-0132.3 011025	ATE Ø 22,2 ohne Bremsflüssigkeitsbehälter
				11/12→; +PR 1ZA; für Rechtslenker		24.4153-0202.3 011027	ATE Ø 23,8 ohne Bremsflüssigkeitsbehälter
2.0 TDI	81	06/14→09/18		12/14→; für Rechtslenker		24.4153-0202.3 011027	ATE Ø 23,8 ohne Bremsflüssigkeitsbehälter
2.0 TDI	103	04/12→07/16		11/12→; für Rechtslenker; +PR 1ZP		24.4152-0132.3 011025	ATE Ø 22,2 ohne Bremsflüssigkeitsbehälter
				11/12→; +PR 1ZE; für Rechtslenker		24.4153-0202.3 011027	ATE Ø 23,8 ohne Bremsflüssigkeitsbehälter
2.0 TDI	110	09/14→09/18		für Rechtslenker; +PR 1ZP		24.4152-0132.3 011025	ATE Ø 22,2 ohne Bremsflüssigkeitsbehälter
				für Rechtslenker; +PR 1ZE		24.4153-0202.3 011027	ATE Ø 23,8 ohne Bremsflüssigkeitsbehälter
2.0 TFSI	147	12/11→07/16		11/12→; für Rechtslenker; +PR 1LV		24.4152-0132.3 011025	ATE Ø 22,2 ohne Bremsflüssigkeitsbehälter
				11/12→; +PR 1ZA / 1ZB; für Rechtslenker		24.4153-0202.3 011027	ATE Ø 23,8 ohne Bremsflüssigkeitsbehälter
2.0 TSI	155	12/12→07/19		05/13→; für Rechtslenker; +PR 1LV		24.4152-0132.3 011025	ATE Ø 22,2 ohne Bremsflüssigkeitsbehälter
				05/13→; für Rechtslenker; +PR 1ZA / 1ZB		24.4153-0202.3 011027	ATE Ø 23,8 ohne Bremsflüssigkeitsbehälter
2.5	125	12/11→07/16		12/12→; für Rechtslenker		24.4152-0132.3 011025	ATE Ø 22,2 ohne Bremsflüssigkeitsbehälter
						24.4153-0202.3 011027	ATE Ø 23,8 ohne Bremsflüssigkeitsbehälter
VW - BORA (9M2) 01/05→12/14							
 Bremskraftverstärker							
2.0	85	01/05→12/14		→ 1J-2-373846; für Linkslenker; + ESP		03.7860-0602.4 300141	ATE Ø 10" pneumatisch
				für Linkslenker; + ESP		03.7863-0402.4 300124	ATE Ø 10" pneumatisch
				1J-2-373847→; für Linkslenker; + ESP		03.7863-3502.4 300128	ATE Ø 10" pneumatisch
 Hauptbremszylinder							
2.0	85	01/05→12/14		für Linkslenker; + ESP		03.2123-2024.3 010597	ATE Ø 23,8
						03.2123-2715.3 010802	ATE Ø 23,8
→							

	kw					! #		
VW - BORA (9M2) 01/05→12/14								
 Hauptbremszylinder								
2.0	85	01/05→12/14		für Rechtslenker; + ESP		03.2123-2774.3	010803	ATE Ø 23,8
				für Linkslenker; - ESP		24.2123-1709.3	010503	Ø 23,8
VW - BORA I (1J2) 10/98→12/13								
 Bremskraftverstärker								
1.4 16V	55	03/00→05/05		09/00→; → 1J-2-373846; für Linkslenker; + ESP		03.7860-0602.4	300141	ATE Ø 10" pneumatisch
1.6	74 - 75	10/98→05/05		→ 08/00; für Linkslenker; + ESP		03.7863-0402.4	300124	ATE Ø 10" pneumatisch
1.6 16V	77	05/00→05/05		1J-2-373847→; für Linkslenker; + ESP; → 12/04		03.7863-3502.4	300128	ATE Ø 10" pneumatisch
1.8	92	10/98→05/05						
1.8 4motion	92	02/99→05/05						
1.9 SDI	50	10/98→05/05						
2.0	85	10/98→12/13						
1.6	78	06/02→10/04		→ 1J-2-373846; für Linkslenker; + ESP		03.7860-0602.4	300141	ATE Ø 10" pneumatisch
				für Linkslenker; + ESP		03.7863-0402.4	300124	ATE Ø 10" pneumatisch
				1J-2-373847→; für Linkslenker; + ESP		03.7863-3502.4	300128	ATE Ø 10" pneumatisch
1.6 FSI	81	01/02→05/05		→ 1J-2-373846; für Linkslenker; + ESP		03.7860-0602.4	300141	ATE Ø 10" pneumatisch
1.9 TDI	74	09/00→05/05		1J-2-373847→; für Linkslenker; + ESP; → 12/04		03.7863-3502.4	300128	ATE Ø 10" pneumatisch
1.9 TDI 4motion	74	09/00→05/05						
2.0 4motion	85	04/00→05/05						
2.3 V5	125	10/00→05/05						
2.3 V5 4motion	125	10/00→05/05						
1.8 T	110	05/00→05/05		09/00→; → 1J-2-373846; für Linkslenker; + ESP		03.7860-0602.4	300141	ATE Ø 10" pneumatisch
				1J-2-373847→; für Linkslenker; + ESP; → 12/04		03.7863-3502.4	300128	ATE Ø 10" pneumatisch
1.8 T	132	03/02→05/05		05/02→; für Linkslenker; + ESP; → 12/04		03.7863-3502.4	300128	ATE Ø 10" pneumatisch
1.9 TDI	66	10/98→05/05		09/00→ 06/01; für Linkslenker; + ESP		03.7860-0602.4	300141	ATE Ø 10" pneumatisch
				→ 08/00; für Linkslenker; + ESP		03.7863-0402.4	300124	ATE Ø 10" pneumatisch
1.9 TDI	81	10/98→06/01		09/00→; für Linkslenker; + ESP		03.7860-0602.4	300141	ATE Ø 10" pneumatisch
1.9 TDI 4motion	85	02/99→06/01		→ 08/00; für Linkslenker; + ESP		03.7863-0402.4	300124	ATE Ø 10" pneumatisch
1.9 TDI	85	12/98→01/02		09/00→ 06/01; für Linkslenker; + ESP		03.7860-0602.4	300141	ATE Ø 10" pneumatisch
1.9 TDI 4motion	66	11/98→04/02		02/99→ 08/00; für Linkslenker; + ESP		03.7863-0402.4	300124	ATE Ø 10" pneumatisch
1.9 TDI	96	11/00→05/05		04/01→; → 1J-2-373846; für Linkslenker; + ESP		03.7860-0602.4	300141	ATE Ø 10" pneumatisch
1.9 TDI 4motion	96	11/00→05/05		1J-2-373847→; für Linkslenker; + ESP; → 12/04		03.7863-3502.4	300128	ATE Ø 10" pneumatisch
1.9 TDI	110	05/00→05/05		10/00→; → 1J-2-373846; für Linkslenker; + ESP		03.7860-0602.4	300141	ATE Ø 10" pneumatisch
1.9 TDI 4motion	110	05/00→05/05		1J-2-373847→; für Linkslenker; + ESP; → 12/04		03.7863-3502.4	300128	ATE Ø 10" pneumatisch
2.3 V5	110	10/98→10/00		09/00→; → 1J-2-373846; für Linkslenker; + ESP		03.7860-0602.4	300141	ATE Ø 10" pneumatisch
				→ 08/00; für Linkslenker; + ESP		03.7863-0402.4	300124	ATE Ø 10" pneumatisch
				1J-2-373847→; für Linkslenker; + ESP		03.7863-3502.4	300128	ATE Ø 10" pneumatisch
2.3 V5 4motion	110	12/98→10/00		09/00→; → 1J-2-373846; für Linkslenker; + ESP		03.7860-0602.4	300141	ATE Ø 10" pneumatisch
				02/99→ 08/00; für Linkslenker; + ESP		03.7863-0402.4	300124	ATE Ø 10" pneumatisch
				1J-2-373847→; für Linkslenker; + ESP		03.7863-3502.4	300128	ATE Ø 10" pneumatisch
2.8 V6 4motion	150	03/99→05/05		09/00→; → 1J-2-373846; für Linkslenker; + ESP		03.7860-0602.4	300141	ATE Ø 10" pneumatisch
				05/99→ 08/00; für Linkslenker; + ESP		03.7863-0402.4	300124	ATE Ø 10" pneumatisch
				1J-2-373847→; für Linkslenker; + ESP; → 12/04		03.7863-3502.4	300128	ATE Ø 10" pneumatisch
 Hauptbremszylinder								
1.4 16V	55	03/00→05/05		→ 08/00; für Linkslenker; + ESP		03.2123-2024.3	010597	ATE Ø 23,8
1.6	74 - 75	10/98→05/05		09/00→; für Linkslenker; + ESP; → 12/04		03.2123-2715.3	010802	ATE Ø 23,8
1.6 16V	77	05/00→05/05		09/00→; für Rechtslenker; + ESP; → 12/04		03.2123-2774.3	010803	ATE Ø 23,8
1.8	92	10/98→05/05		für Linkslenker; - ESP; → 12/04		24.2123-1709.3	010503	Ø 23,8
1.8 4motion	92	02/99→05/05						
1.9 SDI	50	10/98→05/05						
2.0	85	10/98→12/13						
1.6	78	06/02→10/04		für Linkslenker; + ESP		03.2123-2024.3	010597	ATE Ø 23,8
				für Rechtslenker; + ESP		03.2123-2715.3	010802	ATE Ø 23,8
				für Linkslenker; - ESP		24.2123-1709.3	010503	Ø 23,8
1.6 FSI	81	01/02→05/05		für Linkslenker; + ESP; → 12/04		03.2123-2715.3	010802	ATE Ø 23,8
1.9 TDI	74	09/00→05/05		für Rechtslenker; + ESP; → 12/04		03.2123-2774.3	010803	ATE Ø 23,8
1.9 TDI 4motion	74	09/00→05/05						
→								

VW - BORA I (1J2) 10/98→12/13











Hauptbremszylinder

2.0 4motion 2.3 V5 2.3 V5 4motion	85 125 125	04/00→05/05 10/00→05/05 10/00→05/05		für Linkslenker; - ESP; → 12/04			Ø 23,8
1.8 T	110	05/00→05/05		09/00→; für Linkslenker; + ESP; → 12/04	03.2123-2715.3	010503	ATE Ø 23,8
				09/00→; für Rechtslenker; + ESP; → 12/04	03.2123-2774.3	010803	ATE Ø 23,8
				09/00→; für Linkslenker; - ESP; → 12/04	24.2123-1709.3	010503	Ø 23,8
1.8 T	132	03/02→05/05		05/02→; für Linkslenker; + ESP; → 12/04	03.2123-2715.3	010802	ATE Ø 23,8
				05/02→; für Rechtslenker; + ESP; → 12/04	03.2123-2774.3	010803	ATE Ø 23,8
				05/02→; für Linkslenker; - ESP; → 12/04	24.2123-1709.3	010503	Ø 23,8
1.9 TDI	66	10/98→05/05		→ 08/00; für Linkslenker; + ESP	03.2123-2024.3	010597	ATE Ø 23,8
				09/00→ 06/01; für Linkslenker; + ESP	03.2123-2715.3	010802	ATE Ø 23,8
				09/00→ 06/01; für Rechtslenker; + ESP	03.2123-2774.3	010803	ATE Ø 23,8
				→ 06/01; für Linkslenker; - ESP	24.2123-1709.3	010503	Ø 23,8
1.9 TDI 1.9 TDI 4motion 2.3 V5	81 85 110	10/98→06/01 02/99→06/01 10/98→10/00		→ 08/00; für Linkslenker; + ESP	03.2123-2024.3	010597	ATE Ø 23,8
				09/00→; für Linkslenker; + ESP	03.2123-2715.3	010802	ATE Ø 23,8
				09/00→; für Rechtslenker; + ESP	03.2123-2774.3	010803	ATE Ø 23,8
				für Linkslenker; - ESP	24.2123-1709.3	010503	Ø 23,8
1.9 TDI 1.9 TDI 4motion	85 66	12/98→01/02 11/98→04/02		02/99→ 08/00; für Linkslenker; + ESP	03.2123-2024.3	010597	ATE Ø 23,8
				09/00→ 06/01; für Linkslenker; + ESP	03.2123-2715.3	010802	ATE Ø 23,8
				09/00→ 06/01; für Rechtslenker; + ESP	03.2123-2774.3	010803	ATE Ø 23,8
				02/99→ 06/01; für Linkslenker; - ESP	24.2123-1709.3	010503	Ø 23,8
1.9 TDI 1.9 TDI 4motion	96 96	11/00→05/05 11/00→05/05		04/01→; für Linkslenker; + ESP; → 12/04	03.2123-2715.3	010802	ATE Ø 23,8
				04/01→; für Rechtslenker; + ESP; → 12/04	03.2123-2774.3	010803	ATE Ø 23,8
				04/01→; für Linkslenker; - ESP; → 12/04	24.2123-1709.3	010503	Ø 23,8
1.9 TDI 1.9 TDI 4motion	110 110	05/00→05/05 05/00→05/05		10/00→; für Linkslenker; + ESP; → 12/04	03.2123-2715.3	010802	ATE Ø 23,8
				10/00→; für Rechtslenker; + ESP; → 12/04	03.2123-2774.3	010803	ATE Ø 23,8
				10/00→; für Linkslenker; - ESP; → 12/04	24.2123-1709.3	010503	Ø 23,8
2.3 V5 4motion	110	12/98→10/00		02/99→ 08/00; für Linkslenker; + ESP	03.2123-2024.3	010597	ATE Ø 23,8
				09/00→; für Linkslenker; + ESP	03.2123-2715.3	010802	ATE Ø 23,8
				09/00→; für Rechtslenker; + ESP	03.2123-2774.3	010803	ATE Ø 23,8
				02/99→; für Linkslenker; - ESP	24.2123-1709.3	010503	Ø 23,8
2.8 V6 4motion	150	03/99→05/05		05/99→ 08/00; + ESP; für Linkslenker	03.2123-2024.3	010597	ATE Ø 23,8
				09/00→; für Linkslenker; + ESP; → 12/04	03.2123-2715.3	010802	ATE Ø 23,8
				09/00→; für Rechtslenker; + ESP; → 12/04	03.2123-2774.3	010803	ATE Ø 23,8
				05/99→; für Linkslenker; - ESP; → 12/04	24.2123-1709.3	010503	Ø 23,8













VW - BORA Variant (1J6) 05/99→05/05













Bremskraftverstärker













1.4 16V 1.6 FSI 1.9 TDI	55 81 74 - 110	09/01→05/05 01/02→05/05 09/00→05/05		→ 1J-2-373846; für Linkslenker; + ESP			ATE Ø 10" pneumatisch
1.9 TDI 4motion	74 - 110	09/00→05/05		1J-2-373847→; für Linkslenker; + ESP; → 12/04	03.7863-3502.4	300128	ATE Ø 10" pneumatisch
2.0 4motion 2.3 V5 2.3 V5 4motion	85 125 125	04/00→05/05 10/00→05/05 10/00→05/05					
1.6	74 - 75	05/99→05/05		09/00→; → 1J-2-373846; für Linkslenker; + ESP	03.7860-0602.4	300141	ATE Ø 10" pneumatisch
1.6 16V 1.8 4motion	77 92	02/00→05/05 05/99→05/05		→ 08/00; für Linkslenker; + ESP	03.7863-0402.4	300124	ATE Ø 10" pneumatisch
2.0 2.8 V6 4motion	85 150	05/99→05/05 05/99→05/05		1J-2-373847→; für Linkslenker; + ESP; → 12/04	03.7863-3502.4	300128	ATE Ø 10" pneumatisch
1.8 T	110	05/00→05/05		09/00→; → 1J-2-373846; für Linkslenker; + ESP	03.7860-0602.4	300141	ATE Ø 10" pneumatisch
				1J-2-373847→; für Linkslenker; + ESP; → 12/04	03.7863-3502.4	300128	ATE Ø 10" pneumatisch
1.8 T	132	05/02→05/05		für Linkslenker; + ESP; → 12/04	03.7863-3502.4	300128	ATE Ø 10" pneumatisch
1.9 TDI	81 - 85	05/99→06/01		09/00→; für Linkslenker; + ESP	03.7860-0602.4	300141	ATE Ø 10" pneumatisch
1.9 TDI 4motion	85	05/99→06/01		→ 08/00; für Linkslenker; + ESP	03.7863-0402.4	300124	ATE Ø 10" pneumatisch
1.9 TDI 1.9 TDI 4motion →	96 96	11/00→05/05 11/00→05/05		04/01→; → 1J-2-373846; für Linkslenker; + ESP	03.7860-0602.4	300141	ATE Ø 10" pneumatisch













	kw			 	! #		
VW - BORA Variant (1J6) 05/99→05/05							
 Bremskraftverstärker							
1.9 TDI	96	11/00→05/05		1J-2-373847→; für Linkslenker; + ESP;		03.7863-3502.4	300128 ATE Ø 10" pneumatisch
1.9 TDI 4motion	96	11/00→05/05		→ 12/04			
2.0 4motion	88	12/99→05/03		04/00→; → 1J-2-373846; für Linkslenker;		03.7860-0602.4	300141 ATE Ø 10" pneumatisch
				+ ESP			
				1J-2-373847→; für Linkslenker; + ESP		03.7863-3502.4	300128 ATE Ø 10" pneumatisch
2.3 V5	110	05/99→10/00		09/00→; → 1J-2-373846; für Linkslenker;		03.7860-0602.4	300141 ATE Ø 10" pneumatisch
2.3 V5 4motion	110	05/99→10/00		+ ESP			
				→ 08/00; für Linkslenker; + ESP		03.7863-0402.4	300124 ATE Ø 10" pneumatisch
				1J-2-373847→; für Linkslenker; + ESP		03.7863-3502.4	300128 ATE Ø 10" pneumatisch
 Hauptbremszylinder							
1.4 16V	55	09/01→05/05		für Linkslenker; + ESP; → 12/04		03.2123-2715.3	010802 ATE Ø 23,8
1.6 FSI	81	01/02→05/05		für Rechtslenker; + ESP; → 12/04		03.2123-2774.3	010803 ATE Ø 23,8
1.8 T	132	05/02→05/05					
1.9 TDI	74 - 110	09/00→05/05		für Linkslenker; - ESP; → 12/04		24.2123-1709.3	010503 Ø 23,8
1.9 TDI 4motion	74 - 110	09/00→05/05					
2.0 4motion	85	04/00→05/05					
2.3 V5	125	10/00→05/05					
2.3 V5 4motion	125	10/00→05/05					
1.6	74 - 75	05/99→05/05		→ 08/00; für Linkslenker; + ESP		03.2123-2024.3	010597 ATE Ø 23,8
1.6 16V	77	02/00→05/05		09/00→; für Linkslenker; + ESP; → 12/04		03.2123-2715.3	010802 ATE Ø 23,8
1.8 4motion	92	05/99→05/05		09/00→; für Rechtslenker; + ESP; → 12/04		03.2123-2774.3	010803 ATE Ø 23,8
2.0	85	05/99→05/05					
2.8 V6 4motion	150	05/99→05/05		für Linkslenker; - ESP; → 12/04		24.2123-1709.3	010503 Ø 23,8
1.8 T	110	05/00→05/05		09/00→; für Linkslenker; + ESP; → 12/04		03.2123-2715.3	010802 ATE Ø 23,8
				09/00→; für Rechtslenker; + ESP; → 12/04		03.2123-2774.3	010803 ATE Ø 23,8
				09/00→; für Linkslenker; - ESP; → 12/04		24.2123-1709.3	010503 Ø 23,8
1.9 TDI	81 - 85	05/99→06/01		→ 08/00; für Linkslenker; + ESP		03.2123-2024.3	010597 ATE Ø 23,8
1.9 TDI 4motion	85	05/99→06/01		09/00→; für Linkslenker; + ESP		03.2123-2715.3	010802 ATE Ø 23,8
2.3 V5	110	05/99→10/00		09/00→; für Rechtslenker; + ESP		03.2123-2774.3	010803 ATE Ø 23,8
2.3 V5 4motion	110	05/99→10/00		für Linkslenker; - ESP		24.2123-1709.3	010503 Ø 23,8
1.9 TDI	96	11/00→05/05		04/01→; für Linkslenker; + ESP; → 12/04		03.2123-2715.3	010802 ATE Ø 23,8
1.9 TDI 4motion	96	11/00→05/05		04/01→; für Rechtslenker; + ESP; → 12/04		03.2123-2774.3	010803 ATE Ø 23,8
				04/01→; für Linkslenker; - ESP; → 12/04		24.2123-1709.3	010503 Ø 23,8
2.0 4motion	88	12/99→05/03		04/00→; für Linkslenker; + ESP		03.2123-2715.3	010802 ATE Ø 23,8
				04/00→; für Rechtslenker; + ESP		03.2123-2774.3	010803 ATE Ø 23,8
				04/00→; für Linkslenker; - ESP		24.2123-1709.3	010503 Ø 23,8
VW - CADDY II Großraumlimousine (9K9B) 11/95→12/04							
 Bremskraftverstärker							
1.4	44	11/95→06/03		für Linkslenker; - ABS		03.7750-6302.4	300161 ATE Ø 9" pneumatisch
1.4 16V	55	08/00→01/04					
1.6	55	06/97→09/00		→ 9K-1-538270; für Linkslenker		10.6350-3902.4	300213 ATE Ø 9" pneumatisch
1.7 SDI	42	07/96→09/00		9K-1-538271→; für Linkslenker		10.6350-4002.4	300285 ATE Ø 9" pneumatisch
1.9 D	47	11/95→01/04					
1.9 SDI	47	11/95→01/04					
1.9 TDI	66	10/96→01/04					
 Hauptbremszylinder							
1.4	44	11/95→06/03		für Linkslenker; - ABS		03.2122-1042.3	010137 Ø 22,2
1.4 16V	55	08/00→01/04		→ 9K-X-514000; für Rechtslenker; - ABS		03.2122-1042.3	010137 Ø 22,2
1.6	55	06/97→09/00					
1.9 D	47	11/95→01/04		für Linkslenker; + ABS		03.2123-1424.3	010637 ATE Ø 23,8
1.9 SDI	47	11/95→01/04		für Rechtslenker; + ABS		03.2123-1484.3	010595 ATE Ø 23,8
1.9 TDI	66	10/96→01/04					
1.7 SDI	42	07/96→09/00		für Linkslenker; - ABS		03.2122-1042.3	010137 Ø 22,2
				→ 9K-X-514000; für Rechtslenker; - ABS		03.2122-1042.3	010137 Ø 22,2
				für Linkslenker; + ABS		03.2123-1424.3	010637 ATE Ø 23,8
Verschlusschraube, Hauptbremszylinder							
1.4	44	11/95→06/03		für Linkslenker; - ABS		03.3517-0101.2	390322
1.4 16V	55	08/00→01/04					
1.6	55	06/97→09/00		→ 9K-X-514000; für Rechtslenker; - ABS		03.3517-0101.2	390322
1.7 SDI	42	07/96→09/00					
1.9 D	47	11/95→01/04					
1.9 SDI	47	11/95→01/04					
1.9 TDI	66	10/96→01/04					

























	kw					! #		
VW - CADDY II Kasten/Großraumlimousine (9K9A) 11/95→01/04								
 Bremskraftverstärker								
1.4	55	08/00→01/04		für Linkslenker; - ABS		03.7750-6302.4	300161	ATE Ø 9" pneumatisch
1.7 SDI	42	07/96→09/00		→ 9K-1-538270; für Linkslenker		10.6350-3902.4	300213	ATE Ø 9" pneumatisch
1.9 D	47	11/95→01/04						
1.9 SDI	47	11/95→01/04		9K-1-538271→; für Linkslenker		10.6350-4002.4	300285	ATE Ø 9" pneumatisch
1.9 SDI	47	11/95→01/04						
1.9 TDI	66	09/96→01/04						
60 1.4	44	11/95→01/04						
75 1.6	55	11/95→09/00						
 Hauptbremszylinder								
1.4	55	08/00→01/04		für Linkslenker; - ABS		03.2122-1042.3	010137	Ø 22,2
1.9 D	47	11/95→01/04		→ 9K-X-514000; für Rechtslenker; - ABS		03.2122-1042.3	010137	Ø 22,2
1.9 SDI	47	11/95→01/04						
1.9 TDI	66	09/96→01/04		für Linkslenker; + ABS		03.2123-1424.3	010637	ATE Ø 23,8
60 1.4	44	11/95→01/04		für Rechtslenker; + ABS		03.2123-1484.3	010595	ATE Ø 23,8
75 1.6	55	11/95→09/00						
1.7 SDI	42	07/96→09/00		für Linkslenker; - ABS		03.2122-1042.3	010137	Ø 22,2
				→ 9K-X-514000; für Rechtslenker; - ABS		03.2122-1042.3	010137	Ø 22,2
				für Linkslenker; + ABS		03.2123-1424.3	010637	ATE Ø 23,8
Verschlusschraube, Hauptbremszylinder								
1.4	55	08/00→01/04		für Linkslenker; - ABS		03.3517-0101.2	390322	
1.7 SDI	42	07/96→09/00		→ 9K-X-514000; für Rechtslenker; - ABS		03.3517-0101.2	390322	
1.9 D	47	11/95→01/04						
1.9 SDI	47	11/95→01/04						
1.9 TDI	66	09/96→01/04						
60 1.4	44	11/95→01/04						
75 1.6	55	11/95→09/00						
VW - CADDY II Pick-up (9U7) 06/96→12/00								
 Hauptbremszylinder								
1.6	55	06/96→12/00		10/97→; - ABS		24.2122-1731.3	010656	Ø 22,2
1.9 D	47	06/96→12/00						
 Bremskraftregler								
1.6	55	06/96→12/00		10/97→		03.6583-0167.3	320140	ATE lastabhängig 8/3 4x
1.9 D	47	06/96→12/00				03.6584-0107.3	320110	ATE lastabhängig 8/4 4x
VW - CADDY III Großraumlimousine (2KB, 2KJ, 2CB, 2CJ) 03/04→05/15								
 Bremskraftverstärker								
1.2 TSI	63 - 77	09/10→05/15		für Linkslenker		03.7873-4302.4	300312	ATE Ø 11" pneumatisch
1.4	55 - 59	03/04→08/10						
1.6	75	04/04→05/15						
1.6 BiFuel	75	05/11→05/15						
1.6 TDI	55 - 75	08/10→05/15						
1.9 D	48	10/05→06/09						
1.9 TDI	55 - 77	04/04→08/10						
1.9 TDI 4motion	77	05/08→08/10						
2.0 EcoFuel	80	04/06→05/15						
2.0 SDI	51	03/04→08/10						
2.0 TDI	103 - 125	09/07→05/15						
2.0 TDI 16V	103	11/10→05/15						
2.0 TDI 16V 4motion	103	11/10→05/15						
2.0 TDI	81	08/10→05/15		10/10→; für Linkslenker		03.7873-4302.4	300312	ATE Ø 11" pneumatisch
2.0 TDI 4motion	81	08/10→05/15						
 Hauptbremszylinder								
1.2 TSI	63 - 77	09/10→05/15		für Linkslenker		03.2122-2129.3	010799	ATE Ø 22,2
1.6 TDI	55 - 75	08/10→05/15		für Rechtslenker		24.4152-0132.3	011025	ATE Ø 22,2 ohne Bremsflüssigkeitsbehälter
2.0 TDI	125	05/12→05/15						
2.0 TDI 16V 4motion	103	11/10→05/15						
1.4	55 - 59	03/04→08/10		für Linkslenker		03.2122-2129.3	010799	ATE Ø 22,2
1.6	75	04/04→05/15		für Rechtslenker; → 2K-6-150 000		24.2122-1981.3	011024	ATE Ø 22,2 ohne Bremsflüssigkeitsbehälter
1.6 BiFuel	75	05/11→05/15						
1.9 D	48	10/05→06/09		2K-7-000 001→; für Rechtslenker		24.4152-0132.3	011025	ATE Ø 22,2 ohne Bremsflüssigkeitsbehälter
1.9 TDI	55 - 77	04/04→08/10						
1.9 TDI 4motion	77	05/08→08/10						
2.0 EcoFuel	80	04/06→05/15						
2.0 SDI	51	03/04→08/10						
→								







	kw			 	! #		
VW - CADDY III Großraumlimousine (2KB, 2KJ, 2CB, 2CJ) 03/04→05/15							
 Hauptbremszylinder							
2.0 TDI 2.0 TDI 16V	103 103	09/07→08/10 11/10→05/15		für Linkslenker		03.2122-2129.3 010799	ATE Ø 22,2
				für Rechtslenker; → 2K-6-150 000		24.2122-1981.3 011024	ATE Ø 22,2 ohne Bremsflüssigkeitsbehälter
				2K-7-000 001→; für Rechtslenker		24.4152-0132.3 011025	ATE Ø 22,2 ohne Bremsflüssigkeitsbehälter
2.0 TDI 2.0 TDI 4motion	81 81	08/10→05/15 08/10→05/15		10/10→; für Linkslenker		03.2122-2129.3 010799	ATE Ø 22,2
				10/10→; für Rechtslenker		24.4152-0132.3 011025	ATE Ø 22,2 ohne Bremsflüssigkeitsbehälter
VW - CADDY III Kasten/Großraumlimousine (2KA, 2KH, 2CA, 2CH) 03/04→05/15							
 Bremskraftverstärker							
1.2 TSI 1.4 1.6 1.6 BiFuel 1.6 TDI 1.9 TDI 1.9 TDI 4motion 2.0 EcoFuel 2.0 SDI 2.0 TDI 2.0 TDI 16V 2.0 TDI 16V 4motion 2.0 TDI 4motion	63 - 77 55 - 59 75 75 55 - 75 55 - 77 77 80 51 62 - 125 103 103 62	09/10→05/15 03/04→08/10 04/04→05/15 05/11→05/15 08/10→05/15 04/04→08/10 11/08→08/10 04/06→05/15 03/04→08/10 09/07→05/15 11/10→05/15 11/10→05/15 12/10→05/15		für Linkslenker		03.7873-4302.4 300312	ATE Ø 11" pneumatisch
2.0 TDI 2.0 TDI 4motion	81 81	08/10→05/15 08/10→05/15		10/10→; für Linkslenker		03.7873-4302.4 300312	ATE Ø 11" pneumatisch
 Hauptbremszylinder							
1.2 TSI 1.6 TDI 2.0 TDI 2.0 TDI 4motion	63 - 77 55 - 75 125 62	09/10→05/15 08/10→05/15 05/12→05/15 12/10→05/15		für Linkslenker		03.2122-2129.3 010799	ATE Ø 22,2
				für Rechtslenker		24.4152-0132.3 011025	ATE Ø 22,2 ohne Bremsflüssigkeitsbehälter
1.4 1.6 1.6 BiFuel 1.9 TDI 1.9 TDI 4motion 2.0 EcoFuel 2.0 SDI 2.0 TDI 2.0 TDI 16V 2.0 TDI 16V 4motion	55 - 59 75 75 55 - 77 77 80 51 62 - 103 103 103	03/04→08/10 04/04→05/15 05/11→05/15 04/04→08/10 11/08→08/10 04/06→05/15 03/04→08/10 09/07→05/15 11/10→05/15 11/10→05/15		für Linkslenker		03.2122-2129.3 010799	ATE Ø 22,2
				für Rechtslenker; → 2K-6-150 000		24.2122-1981.3 011024	ATE Ø 22,2 ohne Bremsflüssigkeitsbehälter
				2K-7-000 001→; für Rechtslenker		24.4152-0132.3 011025	ATE Ø 22,2 ohne Bremsflüssigkeitsbehälter
2.0 TDI 2.0 TDI 4motion	81 81	08/10→05/15 08/10→05/15		10/10→; für Linkslenker		03.2122-2129.3 010799	ATE Ø 22,2
				10/10→; für Rechtslenker		24.4152-0132.3 011025	ATE Ø 22,2 ohne Bremsflüssigkeitsbehälter
VW - CADDY IV Großraumlimousine (SAB, SAJ) 05/15→							
 Hauptbremszylinder							
1.0 TSI 1.2 TSI 1.4 TGI CNG 1.4 TSI 1.6 1.6 TDI 2.0 TDI 2.0 TDI 4motion ABT e-Caddy	62 - 75 62 81 92 - 96 81 55 - 75 55 - 110 81 - 110 83	11/15→09/20 06/15→09/20 06/15→09/20 05/15→09/20 11/15→09/20 05/15→09/20 05/15→09/20 05/15→09/20 04/20→		für Linkslenker		03.2123-3449.3 010808	ATE Ø 23,8
				für Rechtslenker		24.4153-0202.3 011027	ATE Ø 23,8 ohne Bremsflüssigkeitsbehälter
VW - CADDY IV Kasten/Großraumlimousine (SAA, SAH) 05/15→							
 Hauptbremszylinder							
1.0 TSI →	75	11/15→09/20		für Linkslenker		03.2123-3449.3 010808	ATE Ø 23,8

	kW			 	! #		
VW - CADDY IV Kasten/Großraumlimousine (SAA, SAH) 05/15→							
 Hauptbremszylinder							
1.2 TSI	62	06/15→09/20		für Rechtslenker	24.4153-0202.3	011027	ATE Ø 23,8 ohne Bremsflüssigkeitsbehälter
1.4 TGI CNG	81	06/15→09/20					
1.4 TSI	92	05/15→09/20					
	96						
1.6	81	11/15→09/20					
1.6 TDI	55	05/15→09/20					
	75						
2.0 TDI	55	05/15→09/20					
	110						
2.0 TDI 4motion	55	05/15→09/20					
	110						
ABT e-Caddy	83	04/20→					
VW - CADDY ALLTRACK Großraumlimousine (SAB) 05/15→							
 Hauptbremszylinder							
1.0 TSI	62	11/15→		für Linkslenker	03.2123-3449.3	010808	ATE Ø 23,8
	75						
1.2 TSI	62	06/15→		für Rechtslenker	24.4153-0202.3	011027	ATE Ø 23,8 ohne Bremsflüssigkeitsbehälter
1.4 TGI CNG	81	06/15→					
1.4 TSI	92	05/15→					
	96						
1.6 TDI	55	05/15→					
	75						
2.0 TDI	55	05/15→					
	110						
2.0 TDI 4motion	81	05/15→					
	110						
VW - CADDY ALLTRACK Kasten/Großraumlimousine (SAA) 05/15→							
 Hauptbremszylinder							
1.0 TSI	75	11/15→		für Linkslenker	03.2123-3449.3	010808	ATE Ø 23,8
1.2 TSI	62	06/15→					
1.4 TGI CNG	81	06/15→		für Rechtslenker	24.4153-0202.3	011027	ATE Ø 23,8 ohne Bremsflüssigkeitsbehälter
1.4 TSI	92	05/15→					
	96						
1.6 SRE	81	11/15→09/20					
1.6 TDI	55	05/15→					
	75						
2.0 TDI	55	05/15→					
	110						
2.0 TDI 4motion	81	05/15→					
	110						
VW - CADDY Kasten/Großraumlimousine (6K9, 9E7, 9E9) 09/02→12/09							
 Bremskraftverstärker							
1.9 D	47	02/98→06/09		für Linkslenker	03.7873-4302.4	300312	ATE Ø 11" pneumatisch
 Hauptbremszylinder							
1.9 D	47	02/98→06/09		für Linkslenker	03.2122-2129.3	010799	ATE Ø 22,2
				für Rechtslenker; → 2K-6-150 000	24.2122-1981.3	011024	ATE Ø 22,2 ohne Bremsflüssigkeitsbehälter
				2K-7-000 001→; für Rechtslenker	24.4152-0132.3	011025	ATE Ø 22,2 ohne Bremsflüssigkeitsbehälter
VW - CALIFORNIA T5 Camper (7EC, 7EF, 7EG, 7HF) 04/03→08/15							
 Bremskraftverstärker							
1.9 TDI	63	05/07→11/09		+PR 1AJ / 1AE / 1AC / 1AR; → 7H-A-050000	03.7765-1002.4	300246	ATE Ø 10 / 9" pneumatisch
2.0 TDI	77	02/98→06/09					
	62	09/09→08/15		+PR 1AK; → 7H-A-050000	03.7868-3702.4	300208	ATE Ø 10 / 8" pneumatisch
	132						
2.0 TDI 4motion	103	10/09→08/15					
	132						
2.5 TDi	120	05/07→11/09					
2.5 TDI	96	05/07→11/09					
	128						
2.5 TDI 4motion	96	05/07→11/09					
	128						
Pedalwegsensor, Bremspedal							
1.9 TDI	63	05/07→11/09		+PR 1AT; → 7H-A-050000	03.0655-0006.2	370006	ATE
	77						
2.0 TDI	62	09/09→08/15					
	132						
2.0 TDI 4motion	103	10/09→08/15					
	132						
2.5 TDi	120	05/07→11/09					
→							









	kW			 	! #		
VW - CALIFORNIA T5 Camper (7EC, 7EF, 7EG, 7HF) 04/03→08/15							
Pedalwegsensord, Bremspedal							
2.5 TDI	96 - 128	05/07→11/09		+PR 1AT; → 7H-A-050000		03.0655-0006.2 370006	ATE
2.5 TDI 4motion	96 - 128	05/07→11/09					
 Hauptbremszylinder							
1.9 TDI	63 - 77	05/07→11/09		→ 7H-A-050000		03.2126-3014.3 010811	ATE Ø 27
				7H-6-000001→ 7H-6-200000; für Rechtslenker; +PR 1AT		03.2126-3014.3 010811	ATE Ø 27
				7H-A-200001→		03.2126-3144.3 010941	ATE Ø 27
2.0 TDI	62 - 132	09/09→08/15		→ 7H-A-050000		03.2126-3014.3 010811	ATE Ø 27
2.0 TDI 4motion	100 - 132	10/09→08/15		7H-A-200001→		03.2126-3144.3 010941	ATE Ø 27
2.5 TDi	120	05/07→11/09					
2.5 TDI	96 - 128	05/07→11/09					
2.5 TDI 4motion	96 - 128	05/07→11/09					
2.0 TDI	84 - 150	05/11→08/15				03.2126-3144.3 010941	ATE Ø 27
2.0 TSI	110 - 150	05/11→08/15					
2.0 TSI 4motion	150	07/11→08/15					
VW - CC B7 (358) 11/11→12/16							
 Bremskraftverstärker							
1.4 TSI	110 - 118	11/11→12/16		+PR 1ZG; für Linkslenker		03.7873-4402.4 300292	ATE Ø 11" pneumatisch
1.4 TSI MultiFuel	118	11/11→12/16		+PR 1LA / 1LB / 1ZM; für Linkslenker		03.7873-4502.4 300284	ATE Ø 11" pneumatisch
1.8 TSI	112 - 118	11/11→12/16					
2.0 TDI	100 - 135	11/11→12/16					
2.0 TDI 4motion	103 - 130	11/11→12/16					
2.0 TFSI	147	11/11→12/16					
2.0 TSI	155	11/11→12/16					
3.6 FSI 4motion	220	11/11→12/16					
 Hauptbremszylinder							
1.4 TSI	110 - 118	11/11→12/16		+PR 1ZG; für Linkslenker		03.4152-0116.3 010814	ATE Ø 22,2
1.4 TSI MultiFuel	118	11/11→12/16		+PR 1LA / 1LB / 1ZM; für Linkslenker		03.4153-0186.3 010816	ATE Ø 23,8
1.8 TSI	112 - 118	11/11→12/16		für Rechtslenker; +PR 1LA / 1LB / 1ZM		24.4153-0192.3 011026	ATE Ø 23,8 ohne Bremsflüssigkeitsbehälter
2.0 TDI	100 - 135	11/11→12/16					
2.0 TDI 4motion	103 - 130	11/11→12/16					
2.0 TFSI	147	11/11→12/16					
2.0 TSI	155	11/11→12/16					
3.6 FSI 4motion	220	11/11→12/16					
Drucksensord, Bremskraftverstärker							
3.6 FSI 4motion	220	11/11→12/16		+PR 1ZG; für Rechtslenker		03.0655-0101.2 370008	ATE
VW - CRAFTER 30-35 Bus (2E_) 04/06→12/16							
 Hauptbremszylinder							
2.0 TDI	80 - 100	05/11→12/16		07/11→		24.2126-1704.3 010990 24.2126-1708.3 011128	TRW Ø 27 Ø 27 ohne Bremsflüssigkeitsbehälter
2.0 TDI	84 - 120	07/11→12/16				24.2126-1704.3 010990	TRW Ø 27
2.0 TDI 4motion	120	11/11→12/16				24.2126-1708.3 011128	Ø 27 ohne Bremsflüssigkeitsbehälter
2.5 TDI	65 - 120	04/06→05/13		→ 06/11; +PR 0WC / 0WL / 5EV / 5EX		24.2125-1750.3 011050	Ø 25,4 ohne Bremsflüssigkeitsbehälter
				07/11→		24.2126-1704.3 010990 24.2126-1708.3 011128	TRW Ø 27 Ø 27 ohne Bremsflüssigkeitsbehälter
VW - CRAFTER 30-50 Kasten (2E_) 04/06→12/16							
 Hauptbremszylinder							
2.0 TDI	80 - 100	05/11→12/16		07/11→		24.2126-1704.3 010990	TRW Ø 27
→							

	kw					! #		
VW - CRAFTER 30-50 Kasten (2E_) 04/06→12/16								
 Hauptbremszylinder								
2.0 TDI	80 - 100	05/11→12/16		07/11→			24.2126-1708.3 011128	Ø 27 ohne Bremsflüssigkeitsbehälter
2.0 TDI	84 - 120	07/11→12/16					24.2126-1704.3 010990 24.2126-1708.3 011128	TRW Ø 27 Ø 27 ohne Bremsflüssigkeitsbehälter
2.0 TDI 4motion	120	07/11→12/16					24.2126-1704.3 010990	TRW Ø 27
				11/11→			24.2126-1708.3 011128	Ø 27 ohne Bremsflüssigkeitsbehälter
2.5 TDI	65 - 120	04/06→05/13		→ 06/11; +PR 0WC / 0WL / 5EV / 5EX			24.2125-1750.3 011050	Ø 25,4 ohne Bremsflüssigkeitsbehälter
				07/11→			24.2126-1704.3 010990 24.2126-1708.3 011128	TRW Ø 27 Ø 27 ohne Bremsflüssigkeitsbehälter
VW - CRAFTER 30-50 Pritsche/Fahrgestell (2F_) 04/06→12/16								
 Hauptbremszylinder								
2.0 TDI	80 - 100	05/11→12/16		07/11→			24.2126-1704.3 010990 24.2126-1708.3 011128	TRW Ø 27 Ø 27 ohne Bremsflüssigkeitsbehälter
2.0 TDI	84 - 120	07/11→12/16					24.2126-1704.3 010990	TRW Ø 27
2.0 TDI 4motion	120	11/11→12/16					24.2126-1708.3 011128	Ø 27 ohne Bremsflüssigkeitsbehälter
2.5 TDI	65 - 120	04/06→05/13		→ 06/11; +PR 0WC / 0WL / 5EV / 5EX			24.2125-1750.3 011050	Ø 25,4 ohne Bremsflüssigkeitsbehälter
				07/11→			24.2126-1704.3 010990 24.2126-1708.3 011128	TRW Ø 27 Ø 27 ohne Bremsflüssigkeitsbehälter
VW - EOS (1F7, 1F8) 03/06→08/15								
 Bremskraftverstärker								
1.4 TSI	90 - 118	11/07→08/15		für Linkslenker			03.7863-3332.4 300308	ATE Ø 10" pneumatisch
1.6 FSI	85	06/06→05/08						
2.0 TDI	100 - 103	06/06→08/15						
2.0 TDI 16V	103	05/08→08/15						
2.0 FSI	110	03/06→05/08		05/06→; für Linkslenker; +PR 1ZD			03.7863-3232.4 300307	ATE Ø 10" pneumatisch
2.0 TFSI	147	03/06→08/15		05/06→; für Linkslenker; +PR 1ZA / 1ZE / 1LJ			03.7863-3332.4 300308	ATE Ø 10" pneumatisch
2.0 TSI	155	11/09→08/15		für Linkslenker; +PR 1ZD			03.7863-3232.4 300307	ATE Ø 10" pneumatisch
3.2 V6	184	06/06→05/09		für Linkslenker; +PR 1ZA / 1ZE / 1LJ			03.7863-3332.4 300308	ATE Ø 10" pneumatisch
3.6 V6	191	05/09→11/10		für Linkslenker; +PR 1ZD			03.7863-3232.4 300307	ATE Ø 10" pneumatisch
				+PR 1LK; für Linkslenker			03.7863-3332.4 300308	ATE Ø 10" pneumatisch
 Hauptbremszylinder								
1.4 TSI	90 - 118	11/07→08/15		für Linkslenker; +PR 1AT / 1ZD			03.2122-2129.3 010799	ATE Ø 22,2
1.6 FSI	85	06/06→05/08		für Linkslenker; +PR 1ZA / 1ZE / 1LJ / 1LK			03.2123-3449.3 010808	ATE Ø 23,8
2.0 TDI	100 - 103	06/06→08/15		für Rechtslenker; +PR 1ZD			24.4152-0132.3 011025	ATE Ø 22,2 ohne Bremsflüssigkeitsbehälter
2.0 TDI 16V	103	05/08→08/15						
2.0 TSI	155	11/09→08/15		für Rechtslenker; +PR 1ZA / 1ZE / 1LJ			24.4153-0202.3 011027	ATE Ø 23,8 ohne Bremsflüssigkeitsbehälter
3.2 V6	184	06/06→05/09						
3.6 V6	191	05/09→11/10						
2.0 FSI	110	03/06→05/08		05/06→; für Linkslenker; +PR 1AT / 1ZD			03.2122-2129.3 010799	ATE Ø 22,2
2.0 TFSI	147	03/06→08/15		05/06→; für Linkslenker; +PR 1ZA / 1ZE / 1LJ / 1LK			03.2123-3449.3 010808	ATE Ø 23,8
				05/06→; für Rechtslenker; +PR 1ZD			24.4152-0132.3 011025	ATE Ø 22,2 ohne Bremsflüssigkeitsbehälter
				05/06→; für Rechtslenker; +PR 1ZA / 1ZE / 1LJ			24.4153-0202.3 011027	ATE Ø 23,8 ohne Bremsflüssigkeitsbehälter
VW - FOX Schrägheck (5Z1, 5Z3, 5Z4) 08/03→10/15								
 Hauptbremszylinder								
1.2	40	04/05→07/11		+PR 1ZF / 1AC / 1AT; + ABS			24.2120-1734.3 010702	Ø 20,6
1.4	55	04/05→12/09						
1.4 TDI	51	04/05→12/09		+PR 1ZN; + ABS			24.2120-1734.3 010702	Ø 20,6
1.2	44	09/10→12/11		→ 08/11; +PR 1ZF / 1AC / 1AT; + ABS			24.2120-1734.3 010702	Ø 20,6
1.6	74	10/03→08/14						
1.6 Total Flex	74	10/03→08/14		→ 08/11; +PR 1ZN; + ABS			24.2120-1734.3 010702	Ø 20,6















	kW			 	! #		
VW - FOX Van (5Z1) 09/10→12/11							
 Hauptbremszylinder							
1.2	44	09/10→12/11		→ 08/11; +PR 1ZF / 1AC / 1AT; + ABS	24.2120-1734.3	010702	Ø 20,6
				→ 08/11; +PR 1ZN; + ABS	24.2120-1734.3	010702	Ø 20,6
VW - GOLF III Variant (1H5) 07/93→04/99							
 Bremskraftverstärker							
1.4	40 - 44	07/93→04/99		für Linkslenker; - ABS	03.7750-5502.4	300081	ATE Ø 9" pneumatisch
1.6	74	07/94→04/99		1H-SW385335→; für Linkslenker; + ABS	10.6360-2002.4	300143	ATE Ø 10" pneumatisch
1.8	55 - 66	07/93→04/99					
1.8 Syncro	66	10/94→04/99					
1.9 D	47	07/93→04/99					
1.9 TD	55	07/93→04/99					
1.9 TDI	66	03/94→04/99					
1.9 TDI Syncro	66	07/95→04/99					
2.0	85	07/93→04/99					
2.0 Syncro	85	08/95→04/99					
1.9 SDI	47	07/95→04/99		für Linkslenker; - ABS	03.7750-5502.4	300081	ATE Ø 9" pneumatisch
1.9 TDI	81	04/96→04/99		für Linkslenker; + ABS	10.6360-2002.4	300143	ATE Ø 10" pneumatisch
2.9 VR6 Syncro	140	10/94→04/99		1H-SW385335→; für Linkslenker; + ABS	10.6360-2002.4	300143	ATE Ø 10" pneumatisch
 Hauptbremszylinder							
1.4	40 - 44	07/93→04/99		- ABS	03.2120-3943.3	010532	ATE Ø 20,6
				1H-SW385335→; für Linkslenker; + ABS	03.2122-1144.3	010636	ATE Ø 22,2
1.6	74	07/94→04/99		- ABS	03.2122-1042.3	010137	Ø 22,2
1.8	55 - 66	07/93→04/99		1H-SW385335→; für Linkslenker; + ABS	03.2123-1424.3	010637	ATE Ø 23,8
1.9 TDI	66	03/94→04/99		1H-SW385335→; für Rechtslenker; + ABS	03.2123-1484.3	010595	ATE Ø 23,8
2.0	85	07/93→04/99		→ 1H-SW385334; für Linkslenker; + ABS	10.6123-0674.3	010639	ATE Ø 23,8
1.8 Syncro	66	10/94→04/99		- ABS	03.2122-1042.3	010137	Ø 22,2
1.9 TDI Syncro	66	07/95→04/99		1H-SW385335→; für Linkslenker; + ABS	03.2123-1424.3	010637	ATE Ø 23,8
2.0 Syncro	85	08/95→04/99					
1.9 D	47	07/93→04/99		- ABS	03.2122-1042.3	010137	Ø 22,2
1.9 TD	55	07/93→04/99		1H-SW385335→; für Linkslenker; + ABS	03.2122-1144.3	010636	ATE Ø 22,2
1.9 SDI	47	07/95→04/99		- ABS	03.2122-1042.3	010137	Ø 22,2
				für Linkslenker; + ABS	03.2122-1144.3	010636	ATE Ø 22,2
1.9 TDI	81	04/96→04/99		- ABS	03.2122-1042.3	010137	Ø 22,2
				für Linkslenker; + ABS	03.2123-1424.3	010637	ATE Ø 23,8
				für Rechtslenker; + ABS	03.2123-1484.3	010595	ATE Ø 23,8
2.9 VR6 Syncro	140	10/94→04/99		1H-SW385335→; für Linkslenker; + ABS	03.2123-1424.3	010637	ATE Ø 23,8
				07/95→; → 1H-SW385334; für Linkslenker; + ABS	10.6123-0674.3	010639	ATE Ø 23,8
Verschlusschraube, Hauptbremszylinder							
1.4	40 - 44	07/93→04/99		- ABS	2	03.3517-0101.2	390322
1.6	74	07/94→04/99		- ABS		03.3517-0101.2	390322
1.8	55 - 66	07/93→04/99					
1.8 Syncro	66	10/94→04/99					
1.9 D	47	07/93→04/99					
1.9 SDI	47	07/95→04/99					
1.9 TD	55	07/93→04/99					
1.9 TDI	66 - 81	03/94→04/99					
1.9 TDI Syncro	66	07/95→04/99					
2.0	85	07/93→04/99					
2.0 Syncro	85	08/95→04/99					
 Bremskraftregler							
1.4	40 - 44	07/93→04/99				03.6584-0107.3	320110
1.6	74	07/94→04/99					
1.8	55 - 66	07/93→04/99					
1.9 D	47	07/93→04/99					
1.9 SDI	47	07/95→04/99					
1.9 TD	55	07/93→04/99					
1.9 TDI	66 - 81	03/94→04/99					
2.0	85	07/93→04/99					











	kw			 	! #		
VW - GOLF IV (1J1) 08/97→04/08							
Bremskraftverstärker							
1.4 16V	55	10/97→05/04		09/00→ 10/01; für Linkslenker; +PR 1AT	03.7860-0602.4	300141	ATE Ø 10" pneumatisch
1.6	75	08/00→06/05		→ 08/00; für Linkslenker; +PR 1AT	03.7863-0402.4	300124	ATE Ø 10" pneumatisch
1.6 16V	77	02/00→06/05		11/01→ 10/03; für Linkslenker; +PR 1AT	03.7863-3502.4	300128	ATE Ø 10" pneumatisch
1.6	74	08/97→05/04		09/00→ 10/01; für Linkslenker; +PR 1AT	03.7860-0602.4	300141	ATE Ø 10" pneumatisch
1.8	92	08/97→06/05		10/97→ 08/00; für Linkslenker; +PR 1AT	03.7863-0402.4	300124	ATE Ø 10" pneumatisch
1.9 SDI	50	08/97→06/05		11/01→ 10/03; für Linkslenker; +PR 1AT	03.7863-3502.4	300128	ATE Ø 10" pneumatisch
1.9 TDI	81	08/97→05/04					
1.6	74	02/01→03/07		für Linkslenker; +PR 1AT	03.7863-3502.4	300128	ATE Ø 10" pneumatisch
2.0 BiFuel	85	05/02→05/03					
1.6 FSI	81	01/02→06/05		→ 10/03; für Linkslenker; +PR 1AT	03.7863-3502.4	300128	ATE Ø 10" pneumatisch
3.2 R32 4motion	177	09/02→06/05					
1.8 4motion	92	05/98→06/05		09/00→ 10/01; für Linkslenker; +PR 1AT	03.7860-0602.4	300141	ATE Ø 10" pneumatisch
				07/98→ 08/00; für Linkslenker; +PR 1AT	03.7863-0402.4	300124	ATE Ø 10" pneumatisch
				11/01→ 10/03; für Linkslenker; +PR 1AT	03.7863-3502.4	300128	ATE Ø 10" pneumatisch
1.8 T	110	08/97→06/05		09/00→; für Linkslenker; +PR 1AT	03.7860-0602.4	300141	ATE Ø 10" pneumatisch
2.3 V5	110	08/97→10/00		10/97→ 08/00; für Linkslenker; +PR 1AT	03.7863-0402.4	300124	ATE Ø 10" pneumatisch
1.8 T GTI	132	08/01→06/05		→ 10/01; für Linkslenker; +PR 1AT	03.7860-0602.4	300141	ATE Ø 10" pneumatisch
2.0 4motion	85	10/00→06/05		11/01→ 10/03; für Linkslenker; +PR 1AT	03.7863-3502.4	300128	ATE Ø 10" pneumatisch
1.9 TDI	66	10/97→05/04		09/00→ 06/01; für Linkslenker; +PR 1AT	03.7860-0602.4	300141	ATE Ø 10" pneumatisch
1.9 TDI 4motion	66	07/98→04/02		→ 08/00; für Linkslenker; +PR 1AT	03.7863-0402.4	300124	ATE Ø 10" pneumatisch
1.9 TDI	74	09/00→06/05		→ 10/01; für Linkslenker; +PR 1AT	03.7860-0602.4	300141	ATE Ø 10" pneumatisch
1.9 TDI 4motion	74	09/00→06/05		11/01→; für Linkslenker; +PR 1AT	03.7863-3502.4	300128	ATE Ø 10" pneumatisch
1.9 TDI	85	12/98→06/01		09/00→; für Linkslenker; +PR 1AT	03.7860-0602.4	300141	ATE Ø 10" pneumatisch
				05/99→ 08/00; für Linkslenker; +PR 1AT	03.7863-0402.4	300124	ATE Ø 10" pneumatisch
1.9 TDI	96	11/00→06/05		04/01→ 10/01; für Linkslenker; +PR 1AT	03.7860-0602.4	300141	ATE Ø 10" pneumatisch
1.9 TDI 4motion	96	11/00→06/05		11/01→ 10/03; für Linkslenker; +PR 1AT	03.7863-3502.4	300128	ATE Ø 10" pneumatisch
1.9 TDI	110	05/00→06/05		09/00→ 10/01; für Linkslenker; +PR 1AT	03.7860-0602.4	300141	ATE Ø 10" pneumatisch
1.9 TDI 4motion	110	02/00→06/05		11/01→ 10/03; für Linkslenker; +PR 1AT	03.7863-3502.4	300128	ATE Ø 10" pneumatisch
1.9 TDI 4motion	85	09/99→06/01		09/00→; für Linkslenker; +PR 1AT	03.7860-0602.4	300141	ATE Ø 10" pneumatisch
				11/99→ 08/00; für Linkslenker; +PR 1AT	03.7863-0402.4	300124	ATE Ø 10" pneumatisch
2.0	85	07/98→05/04		09/00→ 10/01; für Linkslenker; +PR 1AT	03.7860-0602.4	300141	ATE Ø 10" pneumatisch
				08/98→ 08/00; für Linkslenker; +PR 1AT	03.7863-0402.4	300124	ATE Ø 10" pneumatisch
				11/01→ 10/03; für Linkslenker; +PR 1AT	03.7863-3502.4	300128	ATE Ø 10" pneumatisch
2.3 V5	125	10/00→06/05		→ 10/03; für Linkslenker; +PR 1AT	03.7860-0602.4	300141	ATE Ø 10" pneumatisch
2.3 V5 4motion	125	10/00→06/05		11/01→ 10/03; für Linkslenker; +PR 1AT	03.7863-3502.4	300128	ATE Ø 10" pneumatisch
2.3 V5 4motion	110	12/98→10/00		09/00→; für Linkslenker; +PR 1AT	03.7860-0602.4	300141	ATE Ø 10" pneumatisch
				→ 08/00; für Linkslenker; +PR 1AT	03.7863-0402.4	300124	ATE Ø 10" pneumatisch
2.8 VR6	147	03/02→06/05		für Linkslenker; +PR 1AT	03.7860-0602.4	300141	ATE Ø 10" pneumatisch
					03.7863-3502.4	300128	ATE Ø 10" pneumatisch
2.8 VR6 4motion	150	03/99→06/05		09/00→ 10/03; für Linkslenker; +PR 1AT	03.7860-0602.4	300141	ATE Ø 10" pneumatisch
				→ 08/00; für Linkslenker; +PR 1AT	03.7863-0402.4	300124	ATE Ø 10" pneumatisch
				11/01→ 10/03; für Linkslenker; +PR 1AT	03.7863-3502.4	300128	ATE Ø 10" pneumatisch
Hauptbremszylinder							
1.4 16V	55	10/97→05/04		→ 08/00; für Linkslenker; +PR 1AT	03.2123-2024.3	010597	ATE Ø 23,8
1.6	75	08/00→06/05		09/00→ 10/03; für Linkslenker; +PR 1AT	03.2123-2715.3	010802	ATE Ø 23,8
1.6 16V	77	02/00→06/05		09/00→ 10/03; für Rechtslenker; +PR 1AT	03.2123-2774.3	010803	ATE Ø 23,8
2.8 VR6 4motion	150	03/99→06/05		→ 10/03; für Linkslenker; +PR 1AM / 1AC / 1AH / 1AJ	24.2123-1709.3	010503	Ø 23,8
1.6	74	08/97→05/04		10/97→ 08/00; für Linkslenker; +PR 1AT	03.2123-2024.3	010597	ATE Ø 23,8
1.8	92	08/97→06/05		09/00→ 10/03; für Linkslenker; +PR 1AT	03.2123-2715.3	010802	ATE Ø 23,8
1.9 SDI	50	08/97→06/05		09/00→ 10/03; für Rechtslenker; +PR 1AT	03.2123-2774.3	010803	ATE Ø 23,8
1.9 TDI	81	08/97→05/04		10/97→ 10/03; für Linkslenker; +PR 1AM / 1AC / 1AH / 1AJ	24.2123-1709.3	010503	Ø 23,8
1.6	74	02/01→03/07		für Linkslenker; +PR 1AT	03.2123-2715.3	010802	ATE Ø 23,8
1.9 TDI	74	09/00→06/05		für Rechtslenker; +PR 1AT	03.2123-2774.3	010803	ATE Ø 23,8
1.9 TDI 4motion	74	09/00→06/05					
2.0 BiFuel	85	05/02→05/03		für Linkslenker; +PR 1AM / 1AC / 1AH / 1AJ	24.2123-1709.3	010503	Ø 23,8
2.8 VR6	147	03/02→06/05					
1.6 FSI	81	01/02→06/05		→ 10/03; für Linkslenker; +PR 1AT	03.2123-2715.3	010802	ATE Ø 23,8
1.8 T GTI	132	08/01→06/05		→ 10/03; für Rechtslenker; +PR 1AT	03.2123-2774.3	010803	ATE Ø 23,8
2.0 4motion	85	10/00→06/05					
2.3 V5	125	10/00→06/05		→ 10/03; für Linkslenker; +PR 1AM / 1AC / 1AH / 1AJ	24.2123-1709.3	010503	Ø 23,8
2.3 V5 4motion	125	10/00→06/05					
3.2 R32 4motion	177	09/02→06/05					
→							













	kw			 	! #		
VW - GOLF IV (1J1) 08/97→04/08							
 Hauptbremszylinder							
1.8 4motion	92	05/98→06/05		07/98→ 08/00; für Linkslenker; +PR 1AT	03.2123-2024.3	010597	ATE Ø 23,8
				09/00→ 10/03; für Linkslenker; +PR 1AT	03.2123-2715.3	010802	ATE Ø 23,8
				09/00→ 10/03; für Rechtslenker; +PR 1AT	03.2123-2774.3	010803	ATE Ø 23,8
				07/98→ 10/03; für Linkslenker; +PR 1AM / 1AC / 1AH / 1AJ	24.2123-1709.3	010503	Ø 23,8
1.8 T 2.3 V5	110	08/97→06/05		10/97→ 08/00; für Linkslenker; +PR 1AT	03.2123-2024.3	010597	ATE Ø 23,8
	110	08/97→10/00		09/00→; für Linkslenker; +PR 1AT	03.2123-2715.3	010802	ATE Ø 23,8
				09/00→; für Rechtslenker; +PR 1AT	03.2123-2774.3	010803	ATE Ø 23,8
				10/97→; für Linkslenker; +PR 1AM / 1AC / 1AH / 1AJ	24.2123-1709.3	010503	Ø 23,8
1.9 TDI	66	10/97→05/04		→ 08/00; für Linkslenker; +PR 1AT	03.2123-2024.3	010597	ATE Ø 23,8
				09/00→ 04/02; für Linkslenker; +PR 1AT	03.2123-2715.3	010802	ATE Ø 23,8
				09/00→ 06/01; für Rechtslenker; +PR 1AT	03.2123-2774.3	010803	ATE Ø 23,8
				→ 06/01; für Linkslenker; +PR 1AM / 1AC / 1AH / 1AJ	24.2123-1709.3	010503	Ø 23,8
1.9 TDI	85	12/98→06/01		05/99→ 08/00; für Linkslenker; +PR 1AT	03.2123-2024.3	010597	ATE Ø 23,8
				09/00→; für Linkslenker; +PR 1AT	03.2123-2715.3	010802	ATE Ø 23,8
				09/00→; für Rechtslenker; +PR 1AT	03.2123-2774.3	010803	ATE Ø 23,8
				05/99→; für Linkslenker; +PR 1AM / 1AC / 1AH / 1AJ	24.2123-1709.3	010503	Ø 23,8
1.9 TDI 1.9 TDI 4motion	96	11/00→06/05		04/01→ 10/03; für Linkslenker; +PR 1AT	03.2123-2715.3	010802	ATE Ø 23,8
	96	11/00→06/05		04/01→ 10/03; für Rechtslenker; +PR 1AT	03.2123-2774.3	010803	ATE Ø 23,8
				04/01→ 10/03; für Linkslenker; +PR 1AM / 1AC / 1AH / 1AJ	24.2123-1709.3	010503	Ø 23,8
1.9 TDI 1.9 TDI 4motion	110	05/00→06/05		09/00→ 10/03; für Linkslenker; +PR 1AT	03.2123-2715.3	010802	ATE Ø 23,8
	110	02/00→06/05		09/00→ 10/03; für Rechtslenker; +PR 1AT	03.2123-2774.3	010803	ATE Ø 23,8
				09/00→ 10/03; für Linkslenker; +PR 1AM / 1AC / 1AH / 1AJ	24.2123-1709.3	010503	Ø 23,8
1.9 TDI 4motion	66	07/98→04/02		→ 08/00; für Linkslenker; +PR 1AT	03.2123-2024.3	010597	ATE Ø 23,8
				09/00→ 06/01; für Linkslenker; +PR 1AT	03.2123-2715.3	010802	ATE Ø 23,8
				09/00→ 06/01; für Rechtslenker; +PR 1AT	03.2123-2774.3	010803	ATE Ø 23,8
				→ 06/01; für Linkslenker; +PR 1AM / 1AC / 1AH / 1AJ	24.2123-1709.3	010503	Ø 23,8
1.9 TDI 4motion	85	09/99→06/01		11/99→ 08/00; für Linkslenker; +PR 1AT	03.2123-2024.3	010597	ATE Ø 23,8
				09/00→; für Linkslenker; +PR 1AT	03.2123-2715.3	010802	ATE Ø 23,8
				09/00→; für Rechtslenker; +PR 1AT	03.2123-2774.3	010803	ATE Ø 23,8
				11/99→; für Linkslenker; +PR 1AM / 1AC / 1AH / 1AJ	24.2123-1709.3	010503	Ø 23,8
2.0	85	07/98→05/04		08/98→ 08/00; für Linkslenker; +PR 1AT	03.2123-2024.3	010597	ATE Ø 23,8
				09/00→ 10/03; für Linkslenker; +PR 1AT	03.2123-2715.3	010802	ATE Ø 23,8
				09/00→ 10/03; für Rechtslenker; +PR 1AT	03.2123-2774.3	010803	ATE Ø 23,8
				08/98→ 10/03; für Linkslenker; +PR 1AM / 1AC / 1AH / 1AJ	24.2123-1709.3	010503	Ø 23,8
2.3 V5 4motion	110	12/98→10/00		→ 08/00; für Linkslenker; +PR 1AT	03.2123-2024.3	010597	ATE Ø 23,8
				09/00→; für Linkslenker; +PR 1AT	03.2123-2715.3	010802	ATE Ø 23,8
				09/00→; für Rechtslenker; +PR 1AT	03.2123-2774.3	010803	ATE Ø 23,8
				für Linkslenker; +PR 1AM / 1AC / 1AH / 1AJ	24.2123-1709.3	010503	Ø 23,8
VW - GOLF IV (9B3) 03/06→							
 Bremskraftverstärker							
1.6 1.6 Total Flex	74	03/07→12/10		1K-9-400001→; → 11/10; +PR 1ZK; für Linkslenker	03.7860-8802.4	300291	ATE Ø 10" pneumatisch
	74 - 77	03/07→06/14		+PR 1ZD / 1ZF / 1ZP / 1LV; für Linkslenker	03.7863-3232.4	300307	ATE Ø 10" pneumatisch
1.8 GTI 2.0	132	01/07→12/10		1K-9-400001→; → 11/10; +PR 1ZA / 1ZB / 1ZE / 1LJ; für Linkslenker	03.7863-3332.4	300308	ATE Ø 10" pneumatisch
	85	01/07→12/10		→ 1K-9-200000; +PR 1LJ / 1LL / 1LM; für Linkslenker	03.7863-3332.4	300308	ATE Ø 10" pneumatisch
1.8 GTI	142	04/07→12/09		1K-9-400001→; +PR 1ZK; für Linkslenker	03.7860-8802.4	300291	ATE Ø 10" pneumatisch
				+PR 1ZD / 1ZF / 1ZP / 1LV; für Linkslenker	03.7863-3232.4	300307	ATE Ø 10" pneumatisch
→							



















	kw					! #		
VW - GOLF IV (9B3) 03/06→								
 Bremskraftverstärker								
1.8 GTI	142	04/07→12/09		1K-9-400001→; +PR 1ZA / 1ZB / 1ZE / 1LJ; für Linkslenker		03.7863-3332.4	300308	ATE Ø 10" pneumatisch
				→ 1K-9-200000; +PR 1LJ / 1LL / 1LM; für Linkslenker		03.7863-3332.4	300308	ATE Ø 10" pneumatisch
 Hauptbremszylinder								
1.6	74	03/07→12/10		+PR 1ZD / 1ZF / 1ZP / 1LV; für Linkslenker		03.2122-2129.3	010799	ATE Ø 22,2
1.6 Total Flex	74 - 77	03/07→06/14						
1.8 GTI	132 - 142	01/07→12/10		+PR 1ZA / 1ZB / 1ZE / 1LJ; für Linkslenker		03.2123-3449.3	010808	ATE Ø 23,8
2.0	85	01/07→12/10		+PR 1ZD / 1ZF / 1ZP / 1LV; für Rechtslenker		24.4152-0132.3	011025	ATE Ø 22,2 ohne Bremsflüssigkeitsbehälter
				+PR 1ZA / 1ZB / 1ZE / 1LJ; für Rechtslenker		24.4153-0202.3	011027	ATE Ø 23,8 ohne Bremsflüssigkeitsbehälter
VW - GOLF IV Cabriolet (1E7) 06/98→12/02								
 Bremskraftverstärker								
1.6	74	06/98→06/02		für Linkslenker; - ABS; → 02/02		03.7750-5502.4	300081	ATE Ø 9" pneumatisch
1.8	55 - 66	06/98→06/02		1E-S-021847→; für Linkslenker; + ABS; → 02/02		10.6360-2002.4	300143	ATE Ø 10" pneumatisch
1.9 TDI	66	06/98→06/02						
2.0	85	06/98→06/02						
1.9 TDI	81	06/98→06/02		für Linkslenker; - ABS; → 02/02		03.7750-5502.4	300081	ATE Ø 9" pneumatisch
				für Linkslenker; + ABS; → 02/02		10.6360-2002.4	300143	ATE Ø 10" pneumatisch
 Hauptbremszylinder								
1.6	74	06/98→06/02		- ABS; → 02/02		03.2122-1042.3	010137	Ø 22,2
1.8	55 - 66	06/98→06/02		1E-S-021847→; für Linkslenker; + ABS; → 02/02		03.2123-1424.3	010637	ATE Ø 23,8
1.9 TDI	66	06/98→06/02						
2.0	85	06/98→06/02		1E-S-021847→; für Rechtslenker; + ABS; → 02/02		03.2123-1484.3	010595	ATE Ø 23,8
				→ 1E-S-021846; für Linkslenker; + ABS		10.6123-0674.3	010639	ATE Ø 23,8
1.9 TDI	81	06/98→06/02		- ABS; → 02/02		03.2122-1042.3	010137	Ø 22,2
				für Linkslenker; + ABS; → 02/02		03.2123-1424.3	010637	ATE Ø 23,8
				für Rechtslenker; + ABS; → 02/02		03.2123-1484.3	010595	ATE Ø 23,8
Verschlusschraube, Hauptbremszylinder								
1.6	74	06/98→06/02		- ABS; → 02/02		03.3517-0101.2	390322	
1.8	55 - 66	06/98→06/02						
1.9 TDI	66 - 81	06/98→06/02						
2.0	85	06/98→06/02						
 Bremskraftregler								
1.6	74	06/98→06/02		→ 02/02		03.6584-0107.3	320110	ATE lastabhängig 8/4 4x
1.8	55 - 66	06/98→06/02						
1.9 TDI	66	06/98→06/02						
2.0	85	06/98→06/02						
VW - GOLF IV Van (1J1) 10/97→05/04								
 Bremskraftverstärker								
1.9 SDI	50	11/98→05/04		09/00→ 06/01; für Linkslenker; +PR 1AT		03.7860-0602.4	300141	ATE Ø 10" pneumatisch
1.9 TDI	66 - 81	10/97→05/04		→ 08/00; für Linkslenker; +PR 1AT		03.7863-0402.4	300124	ATE Ø 10" pneumatisch
1.9 TDI	96	04/01→05/04		→ 06/01; für Linkslenker; +PR 1AT		03.7860-0602.4	300141	ATE Ø 10" pneumatisch
				→ 10/01; für Linkslenker; +PR 1AT		03.7860-0602.4	300141	ATE Ø 10" pneumatisch
				11/01→ 10/03; für Linkslenker; +PR 1AT		03.7863-3502.4	300128	ATE Ø 10" pneumatisch
1.9 TDI 4motion	85	01/00→04/01		für Linkslenker; +PR 1AT; 09/00→		03.7860-0602.4	300141	ATE Ø 10" pneumatisch
				→ 08/00; für Linkslenker; +PR 1AT		03.7863-0402.4	300124	ATE Ø 10" pneumatisch
 Hauptbremszylinder								
1.9 SDI	50	11/98→05/04		→ 08/00; für Linkslenker; +PR 1AT		03.2123-2024.3	010597	ATE Ø 23,8
1.9 TDI	66 - 81	10/97→05/04		09/00→ 04/02; für Linkslenker; +PR 1AT		03.2123-2715.3	010802	ATE Ø 23,8
				09/00→ 06/01; für Rechtslenker; +PR 1AT		03.2123-2774.3	010803	ATE Ø 23,8
				→ 06/01; für Linkslenker; +PR 1AM / 1AC / 1AH / 1AJ		24.2123-1709.3	010503	Ø 23,8
1.9 TDI	96	04/01→05/04		→ 10/03; für Linkslenker; +PR 1AT		03.2123-2715.3	010802	ATE Ø 23,8
→								













	kw					! #		
VW - GOLF IV Van (1J1) 10/97→05/04								
 Hauptbremszylinder								
1.9 TDI	96	04/01→05/04		→ 04/02; für Linkslenker; +PR 1AT	03.2123-2715.3	010802	ATE Ø 23,8	
				→ 10/03; für Rechtslenker; +PR 1AT	03.2123-2774.3	010803	ATE Ø 23,8	
				→ 06/01; für Rechtslenker; +PR 1AT	03.2123-2774.3	010803	ATE Ø 23,8	
				→ 10/03; für Linkslenker; +PR 1AM / 1AC / 1AH / 1AJ	24.2123-1709.3	010503	Ø 23,8	
				→ 06/01; für Linkslenker; +PR 1AM / 1AC / 1AH / 1AJ	24.2123-1709.3	010503	Ø 23,8	
1.9 TDI 4motion	85	01/00→04/01		→ 08/00; für Linkslenker; +PR 1AT	03.2123-2024.3	010597	ATE Ø 23,8	
				09/00→; für Linkslenker; +PR 1AT	03.2123-2715.3	010802	ATE Ø 23,8	
				09/00→; für Rechtslenker; +PR 1AT	03.2123-2774.3	010803	ATE Ø 23,8	
				für Linkslenker; +PR 1AM / 1AC / 1AH / 1AJ	24.2123-1709.3	010503	Ø 23,8	
VW - GOLF IV Variant (1J5) 05/99→06/06								
 Bremskraftverstärker								
1.4 16V	55	05/99→06/06		09/00→ 10/01; für Linkslenker; +PR 1AT	03.7860-0602.4	300141	ATE Ø 10" pneumatisch	
1.6	74 - 75	05/99→06/06		→ 08/00; für Linkslenker; +PR 1AT	03.7863-0402.4	300124	ATE Ø 10" pneumatisch	
1.6 16V	77	02/00→06/06		11/01→; für Linkslenker; +PR 1AT	03.7863-3502.4	300128	ATE Ø 10" pneumatisch	
1.8 4motion	92	05/99→06/06						
1.8 T	110	05/00→06/06						
1.9 SDI	50	05/99→06/06						
1.9 TDI	66	05/99→05/06						
1.9 TDI 4motion	66	05/99→04/02						
2.0	85	05/99→06/06						
2.3 V5	110	05/99→06/06						
2.3 V5 4motion	110	05/99→06/06						
2.8 V6 4motion	150	05/99→06/06						
1.6 FSI	81	01/02→06/06		für Linkslenker; +PR 1AT	03.7863-3502.4	300128	ATE Ø 10" pneumatisch	
1.9 TDI 4motion	110	05/02→06/05						
2.0 Bi-Fuel	85	02/02→06/06						
1.9 TDI	74 - 110	09/00→06/06		für Linkslenker; +PR 1AT; → 10/01	03.7860-0602.4	300141	ATE Ø 10" pneumatisch	
1.9 TDI 4motion	74	09/00→06/06		11/01→; für Linkslenker; +PR 1AT	03.7863-3502.4	300128	ATE Ø 10" pneumatisch	
2.0 4motion	85	10/00→06/06						
2.3 V5	125	10/00→06/06						
2.3 V5 4motion	125	10/00→06/06						
1.9 TDI	81 - 85	05/99→06/01		09/00→; für Linkslenker; +PR 1AT	03.7860-0602.4	300141	ATE Ø 10" pneumatisch	
1.9 TDI 4motion	85	12/99→04/01		→ 08/00; für Linkslenker; +PR 1AT	03.7863-0402.4	300124	ATE Ø 10" pneumatisch	
1.9 TDI	96	11/00→06/06		04/01→; für Linkslenker; +PR 1AT; → 10/01	03.7860-0602.4	300141	ATE Ø 10" pneumatisch	
1.9 TDI 4motion	96	11/00→06/06		11/01→; für Linkslenker; +PR 1AT	03.7863-3502.4	300128	ATE Ø 10" pneumatisch	
2.0 4motion	88	12/99→06/06		09/00→ 10/01; für Linkslenker; +PR 1AT	03.7860-0602.4	300141	ATE Ø 10" pneumatisch	
				04/00→ 08/00; für Linkslenker; +PR 1AT	03.7863-0402.4	300124	ATE Ø 10" pneumatisch	
				11/01→; für Linkslenker; +PR 1AT	03.7863-3502.4	300128	ATE Ø 10" pneumatisch	
 Hauptbremszylinder								
1.4 16V	55	05/99→06/06		→ 08/00; für Linkslenker; +PR 1AT	03.2123-2024.3	010597	ATE Ø 23,8	
1.6	74 - 75	05/99→06/06		09/00→; für Linkslenker; +PR 1AT	03.2123-2715.3	010802	ATE Ø 23,8	
1.6 16V	77	02/00→06/06		09/00→; für Rechtslenker; +PR 1AT	03.2123-2774.3	010803	ATE Ø 23,8	
1.8 4motion	92	05/99→06/06		für Linkslenker; +PR 1AM / 1AC / 1AH / 1AJ	24.2123-1709.3	010503	Ø 23,8	
1.8 T	110	05/00→06/06						
1.9 SDI	50	05/99→06/06						
1.9 TDI	66 - 85	05/99→05/06						
1.9 TDI 4motion	66 - 85	05/99→04/02						
2.0	85	05/99→06/06						
2.3 V5	110	05/99→06/06						
2.3 V5 4motion	110	05/99→06/06						
2.8 V6 4motion	150	05/99→06/06						
1.6 FSI	81	01/02→06/06		für Linkslenker; +PR 1AT	03.2123-2715.3	010802	ATE Ø 23,8	
1.9 TDI	74 - 110	09/00→06/06		für Rechtslenker; +PR 1AT	03.2123-2774.3	010803	ATE Ø 23,8	
1.9 TDI 4motion	74 - 110	09/00→06/06		für Linkslenker; +PR 1AM / 1AC / 1AH / 1AJ	24.2123-1709.3	010503	Ø 23,8	
2.0 4motion	85	10/00→06/06						
2.0 Bi-Fuel	85	02/02→06/06						
2.3 V5	125	10/00→06/06						
2.3 V5 4motion	125	10/00→06/06						
1.9 TDI	96	11/00→06/06		04/01→; für Linkslenker; +PR 1AT	03.2123-2715.3	010802	ATE Ø 23,8	
1.9 TDI 4motion	96	11/00→06/06		04/01→; für Rechtslenker; +PR 1AT	03.2123-2774.3	010803	ATE Ø 23,8	
→								

























	kw					! #		
VW - GOLF IV Variant (1J5) 05/99→06/06								
 Hauptbremszylinder								
1.9 TDI	96	11/00→06/06		04/01→; für Linkslenker; +PR 1AM / 1AC / 1AH / 1AJ		24.2123-1709.3	010503	Ø 23,8
1.9 TDI 4motion	96	11/00→06/06						
2.0 4motion	88	12/99→06/06		04/00→ 08/00; +PR 1AT; für Linkslenker		03.2123-2024.3	010597	ATE Ø 23,8
				09/00→; für Linkslenker; +PR 1AT		03.2123-2715.3	010802	ATE Ø 23,8
				09/00→; für Rechtslenker; +PR 1AT		03.2123-2774.3	010803	ATE Ø 23,8
				04/00→; für Linkslenker; +PR 1AM / 1AC / 1AH / 1AJ		24.2123-1709.3	010503	Ø 23,8
VW - GOLF V (1K1) 10/03→07/10								
 Bremskraftverstärker								
1.4 16V	55	10/03→05/06		für Linkslenker; +PR 1AC / 1AT		03.7863-3232.4	300307	ATE Ø 10" pneumatisch
1.4 FSI	66	10/03→07/06						
1.6 FSI	85	10/03→07/08						
2.0	85	01/05→11/08						
1.4 16V 1.4 TSI 1.6 1.6 MultiFuel 1.9 TDI 1.9 TDI 4motion 2.0 FSI 2.0 FSI 4motion 2.0 SDI 2.0 TDI 2.0 TDI 16V 2.0 TDI 16V 4motion 2.0 TDI 4motion 2.5	59	05/06→11/08		für Linkslenker; → 09/08; +PR 1AC / 1AT		03.7863-3232.4	300307	ATE Ø 10" pneumatisch
	90 - 125	11/05→11/08						
	75	01/04→11/08						
	75	10/07→11/08						
	66 - 77	10/03→11/08						
	77	08/04→11/08						
	110	01/04→11/08						
	110	08/04→11/08						
	55	01/04→11/08						
	100 - 125	10/03→11/08						
	103	10/03→11/08						
	103	08/04→11/08						
	103	01/07→11/08						
	125	05/07→11/08						
2.0 GTI	147 - 169	10/04→02/09		für Linkslenker; → 09/08; +PR 1AC / 1AT		03.7863-3332.4	300308	ATE Ø 10" pneumatisch
3.2 R32 4motion	184	11/05→11/08						
 Hauptbremszylinder								
1.4 16V 1.4 FSI 1.6 FSI	55	10/03→05/06		für Linkslenker; → 1K-6W078889		03.2122-2129.3	010799	ATE Ø 22,2
	66	10/03→07/06		1K-6W078890→; für Linkslenker		03.2122-2129.3	010799	ATE Ø 22,2
	85	10/03→07/08		für Rechtslenker; +PR 1AC / 1AT		24.2122-1981.3	011024	ATE Ø 22,2 ohne Bremsflüssigkeitsbehälter
				für Rechtslenker; +PR 1AS		24.4152-0132.3	011025	ATE Ø 22,2 ohne Bremsflüssigkeitsbehälter
1.4 16V 1.4 TSI 1.6 1.6 MultiFuel 1.9 TDI 1.9 TDI 4motion 2.0 2.0 FSI 2.0 FSI 4motion 2.0 SDI 2.0 TDI 2.0 TDI 16V 2.0 TDI 16V 4motion 2.0 TDI 4motion	59	05/06→11/08		1K-6W078890→; für Linkslenker; → 09/08		03.2122-2129.3	010799	ATE Ø 22,2
	103 - 125	11/05→11/08						
	75	01/04→11/08		für Linkslenker; → 1K-6W078889		03.2122-2129.3	010799	ATE Ø 22,2
	75	10/07→11/08		für Rechtslenker; → 09/08; +PR 1AC / 1AT		24.2122-1981.3	011024	ATE Ø 22,2 ohne Bremsflüssigkeitsbehälter
	66 - 77	10/03→11/08						
	77	08/04→11/08		für Rechtslenker; → 09/08; +PR 1AS		24.4152-0132.3	011025	ATE Ø 22,2 ohne Bremsflüssigkeitsbehälter
	85	01/05→11/08						
	110	01/04→11/08						
	110	08/04→11/08						
	55	01/04→11/08						
	100 - 125	10/03→11/08						
	103	10/03→11/08						
	103	08/04→11/08						
	103	01/07→11/08						
1.4 TSI 2.5	90	05/07→11/08		→ 09/08; für Linkslenker		03.2122-2129.3	010799	ATE Ø 22,2
	125	05/07→11/08		für Rechtslenker; → 09/08; +PR 1AC / 1AT		24.2122-1981.3	011024	ATE Ø 22,2 ohne Bremsflüssigkeitsbehälter
				für Rechtslenker; → 09/08; +PR 1AS		24.4152-0132.3	011025	ATE Ø 22,2 ohne Bremsflüssigkeitsbehälter
2.0 GTI	147 - 169	10/04→02/09		1K-6W078890→; für Linkslenker; → 09/08		03.2123-3449.3	010808	ATE Ø 23,8
				für Linkslenker; → 1K-6W078889		03.2123-3449.3	010808	ATE Ø 23,8
				für Rechtslenker; → 09/08; +PR 1AC / 1AT		24.2122-1981.3	011024	ATE Ø 22,2 ohne Bremsflüssigkeitsbehälter
				für Rechtslenker; → 09/08; +PR 1AS		24.4152-0132.3	011025	ATE Ø 22,2 ohne Bremsflüssigkeitsbehälter
				1K-6W078890→; für Rechtslenker; → 09/08		24.4153-0202.3	011027	ATE Ø 23,8 ohne Bremsflüssigkeitsbehälter
3.2 R32 4motion	184	11/05→11/08		1K-6W078890→; für Linkslenker; → 09/08		03.2123-3449.3	010808	ATE Ø 23,8
→								









	kw					! #		
VW - GOLF V (1K1) 10/03→07/10								
 Hauptbremszylinder								
3.2 R32 4motion	184	11/05→11/08		für Linkslenker; → 1K-6W078889		03.2123-3449.3	010808	ATE Ø 23,8
				1K-6W078890→; für Rechtslenker; → 09/08		24.4153-0202.3	011027	ATE Ø 23,8 ohne Bremsflüssigkeitsbehälter
Drucksensor, Bremskraftverstärker								
1.4 16V	55	10/03→05/06		für Linkslenker; +PR 1AS		03.0655-0101.2	370008	ATE
1.4 FSI	66	10/03→07/06						
1.6 FSI	85	10/03→07/08						
1.4 16V	59	05/06→11/08		für Linkslenker; → 09/08; +PR 1AS		03.0655-0101.2	370008	ATE
1.4 TSI	90 - 125	11/05→11/08						
1.6	75	01/04→11/08						
1.6 MultiFuel	75	10/07→11/08						
1.9 TDI	66 - 77	10/03→11/08						
1.9 TDI 4motion	77	08/04→11/08						
2.0	85	01/05→11/08						
2.0 FSI	110	01/04→11/08						
2.0 FSI 4motion	110	08/04→11/08						
2.0 SDI	55	01/04→11/08						
2.0 TDI	100 - 125	10/03→11/08						
2.0 TDI 16V	103	10/03→11/08						
2.0 TDI 16V 4motion	103	08/04→11/08						
2.0 TDI 4motion	103	01/07→11/08						
2.5	125	05/07→11/08						
VW - GOLF V Variant (1K5) 01/07→07/09								
 Bremskraftverstärker								
1.4	59	06/07→07/09		→ 06/09; für Linkslenker; +PR 1AC / 1AT		03.7863-3232.4	300307	ATE Ø 10" pneumatisch
1.4 TSI	90 - 103	06/07→07/09						
1.6	75	06/07→07/09						
1.6 MultiFuel	75	11/07→07/09						
1.9 TDI	77	06/07→07/09						
1.9 TDI 4motion	77	01/08→07/09						
2.0 TDI	96 - 103	06/07→07/09						
2.0 TDI 16V	103	06/07→07/09						
1.4 TSI	118 - 125	06/07→07/09		→ 06/09; für Linkslenker; +PR 1AC / 1AT		03.7863-3332.4	300308	ATE Ø 10" pneumatisch
2.0 TFSI	147	06/07→07/09						
 Hauptbremszylinder								
1.4	59	06/07→07/09		→ 06/09; für Linkslenker		03.2122-2129.3	010799	ATE Ø 22,2
				→ 06/09; für Rechtslenker		24.4152-0132.3	011025	ATE Ø 22,2 ohne Bremsflüssigkeitsbehälter
1.4 TSI	90 - 103	06/07→07/09		→ 06/09; für Linkslenker; +PR 1AS		03.2122-2129.3	010799	ATE Ø 22,2
1.6	75	06/07→07/09		→ 06/09; für Rechtslenker		24.4152-0132.3	011025	ATE Ø 22,2 ohne Bremsflüssigkeitsbehälter
1.6 MultiFuel	75	11/07→07/09						
1.4 TSI	118	07/08→07/09		→ 06/09; für Linkslenker		03.2122-2129.3	010799	ATE Ø 22,2
				→ 06/09; +PR 1LJ / 1LL; für Linkslenker		03.2123-3449.3	010808	ATE Ø 23,8
				→ 06/09; für Rechtslenker		24.4152-0132.3	011025	ATE Ø 22,2 ohne Bremsflüssigkeitsbehälter
				→ 06/09; +PR 1LJ / 1LL; für Rechtslenker		24.4153-0202.3	011027	ATE Ø 23,8 ohne Bremsflüssigkeitsbehälter
1.4 TSI	125	06/07→07/09		→ 06/09; für Linkslenker; +PR 1AS		03.2122-2129.3	010799	ATE Ø 22,2
				→ 06/09; +PR 1LJ / 1LL; für Linkslenker		03.2123-3449.3	010808	ATE Ø 23,8
				→ 06/09; für Rechtslenker		24.4152-0132.3	011025	ATE Ø 22,2 ohne Bremsflüssigkeitsbehälter
				→ 06/09; +PR 1LJ / 1LL; für Rechtslenker		24.4153-0202.3	011027	ATE Ø 23,8 ohne Bremsflüssigkeitsbehälter
1.9 TDI	77	06/07→07/09		→ 06/09; für Linkslenker; +PR 1AC / 1AT		03.2122-2129.3	010799	ATE Ø 22,2
1.9 TDI 4motion	77	01/08→07/09		→ 06/09; für Rechtslenker		24.4152-0132.3	011025	ATE Ø 22,2 ohne Bremsflüssigkeitsbehälter
2.0 TDI	96 - 103	06/07→07/09						
2.0 TDI 16V	103	06/07→07/09						
2.0 TFSI	147	06/07→07/09		→ 06/09; für Linkslenker; +PR 1AC / 1AT		03.2122-2129.3	010799	ATE Ø 22,2
				→ 06/09; +PR 1LJ / 1LL; für Linkslenker		03.2123-3449.3	010808	ATE Ø 23,8
				→ 06/09; für Rechtslenker		24.4152-0132.3	011025	ATE Ø 22,2 ohne Bremsflüssigkeitsbehälter
				→ 06/09; +PR 1LJ / 1LL; für Rechtslenker		24.4153-0202.3	011027	ATE Ø 23,8 ohne Bremsflüssigkeitsbehälter
→								







	kw			 	! #		
VW - GOLF V Variant (1K5) 01/07→07/09							
Drucksensor, Bremskraftverstärker							
1.4 TSI	90 - 118	06/07→07/09		→ 06/09; für Linkslenker; +PR 1AS		03.0655-0101.2 370008	ATE
2.0 TDI	96 - 103	06/07→07/09					
2.0 TDI 16V	103	06/07→07/09					
1.4 TSI	103 - 125	06/07→07/09		→ 06/09; für Rechtslenker; +PR 1AS		03.0655-0101.2 370008	ATE
1.6	75	06/07→07/09		→ 06/09; +PR 1AS		03.0655-0101.2 370008	ATE
1.6 MultiFuel	75	11/07→07/09					
VW - GOLF VI (5K1) 10/08→12/14							
Bremskraftverstärker							
1.2 TSI	63	05/10→11/12		1K-9-400001→; → 11/10; für Linkslenker; +PR 1ZK		03.7860-8802.4 300291	ATE Ø 10" pneumatisch
1.4	59	10/08→11/12					
1.4 TSI	90 - 118	10/08→11/12		für Linkslenker; +PR 1ZD / 1ZF / 1ZP / 1LV		03.7863-3232.4 300307	ATE Ø 10" pneumatisch
1.6	75	10/08→11/12		1K-9-400001→; → 11/10; für Linkslenker; +PR 1ZA / 1ZB / 1ZE / 1LJ		03.7863-3332.4 300308	ATE Ø 10" pneumatisch
1.6 BiFuel	75	03/09→11/12					
1.6 MultiFuel	75	10/08→11/12					
1.6 TDI	66 - 77	02/09→11/12		→ 1K-9-200000; für Linkslenker; +PR 1LJ / 1LL / 1LM		03.7863-3332.4 300308	ATE Ø 10" pneumatisch
2.0 GTI	147 - 155	04/09→11/13					
2.0 R 4motion	188 - 199	11/09→11/13					
2.0 TDI	81 - 125	10/08→05/13					
2.0 TDI 4motion	103	05/09→11/12					
2.5	125	07/09→05/13					
1.2 TSI	77	11/08→11/12		1K-9-400001→; → 11/10; für Linkslenker; +PR 1ZK		03.7860-8802.4 300291	ATE Ø 10" pneumatisch
				05/09→; für Linkslenker; +PR 1ZD / 1ZF / 1ZP / 1LV		03.7863-3232.4 300307	ATE Ø 10" pneumatisch
				05/09→; → 1K-9-200000; für Linkslenker; +PR 1LJ / 1LL / 1LM		03.7863-3332.4 300308	ATE Ø 10" pneumatisch
				1K-9-400001→; → 11/10; für Linkslenker; +PR 1ZA / 1ZB / 1ZE / 1LJ		03.7863-3332.4 300308	ATE Ø 10" pneumatisch
1.8 TSI	118	06/09→01/11		1K-9-400001→; → 11/10; für Linkslenker; +PR 1ZK		03.7860-8802.4 300291	ATE Ø 10" pneumatisch
				für Linkslenker; +PR 1ZD / 1ZF / 1ZP / 1LV		03.7863-3232.4 300307	ATE Ø 10" pneumatisch
				→ 1K-9-200000; für Linkslenker		03.7863-3332.4 300308	ATE Ø 10" pneumatisch
				1K-9-400001→; → 11/10; für Linkslenker; +PR 1ZA / 1ZB / 1ZE / 1LJ		03.7863-3332.4 300308	ATE Ø 10" pneumatisch
2.0 GTI	173	05/11→11/12		für Linkslenker; +PR 1ZD / 1ZF / 1ZP / 1LV		03.7863-3232.4 300307	ATE Ø 10" pneumatisch
2.0 TFSI 4motion	191	09/11→11/13		→ 1K-9-200000; für Linkslenker; +PR 1LJ / 1LL / 1LM		03.7863-3332.4 300308	ATE Ø 10" pneumatisch
Hauptbremszylinder							
1.2 TSI	63	05/10→11/12		für Linkslenker; +PR 1ZD / 1ZF / 1ZP / 1LV		03.2122-2129.3 010799	ATE Ø 22,2
1.4	59	10/08→11/12					
1.4 TSI	90 - 118	10/08→11/12		für Linkslenker; +PR 1ZA / 1ZB / 1ZE / 1LJ		03.2123-3449.3 010808	ATE Ø 23,8
1.6	75	10/08→11/12		für Rechtslenker; +PR 1ZD / 1ZF / 1ZP / 1LV		24.4152-0132.3 011025	ATE Ø 22,2 ohne Bremsflüssigkeitsbehälter
1.6 BiFuel	75	03/09→11/12					
1.6 MultiFuel	75	10/08→11/12					
1.6 TDI	66 - 77	02/09→11/12		für Rechtslenker; +PR 1ZA / 1ZB / 1ZE / 1LJ		24.4153-0202.3 011027	ATE Ø 23,8 ohne Bremsflüssigkeitsbehälter
1.8 TSI	118	06/09→01/11					
2.0 GTI	147 - 173	04/09→11/13					
2.0 R 4motion	188 - 199	11/09→11/13					
2.0 TDI	81 - 125	10/08→05/13					
2.0 TDI 4motion	103	05/09→11/12					
2.0 TFSI 4motion	191	09/11→11/13					
2.5	125	07/09→05/13					
1.2 TSI	77	11/08→11/12		05/09→; für Linkslenker; +PR 1ZD / 1ZF / 1ZP / 1LV		03.2122-2129.3 010799	ATE Ø 22,2
				05/09→; für Linkslenker; +PR 1ZA / 1ZB / 1ZE / 1LJ		03.2123-3449.3 010808	ATE Ø 23,8
				05/09→; für Rechtslenker; +PR 1ZD / 1ZF / 1ZP / 1LV		24.4152-0132.3 011025	ATE Ø 22,2 ohne Bremsflüssigkeitsbehälter
				05/09→; für Rechtslenker; +PR 1ZA / 1ZB / 1ZE / 1LJ		24.4153-0202.3 011027	ATE Ø 23,8 ohne Bremsflüssigkeitsbehälter







	kw				! #		
VW - GOLF VI Cabriolet (517) 03/11→05/16							
 Bremskraftverstärker							
1.2 TSI	77	03/11→05/16		06/11→; für Linkslenker; +PR 1ZK	03.7860-8802.4	300291	ATE Ø 10" pneumatisch
1.4 TSI	118	03/11→05/16		06/11→; für Linkslenker; +PR 1ZD / 1ZP / 1LV	03.7863-3232.4	300307	ATE Ø 10" pneumatisch
1.6 TDI	77	03/11→05/16		06/11→; für Linkslenker; +PR 1ZA / 1ZB / 1ZE	03.7863-3332.4	300308	ATE Ø 10" pneumatisch
1.2 TSI 16V	77	11/13→05/16		für Linkslenker; +PR 1ZK	03.7860-8802.4	300291	ATE Ø 10" pneumatisch
1.4 TSI	90 - 110	11/11→05/16		für Linkslenker; +PR 1ZD / 1ZP / 1LV	03.7863-3232.4	300307	ATE Ø 10" pneumatisch
2.0 GTI	155	05/12→05/16		für Linkslenker; +PR 1ZA / 1ZB / 1ZE	03.7863-3332.4	300308	ATE Ø 10" pneumatisch
2.0 R	195	01/13→05/16					
2.0 TDI	81 - 110	11/11→05/16					
2.0 TSI	162	11/13→05/16					
 Hauptbremszylinder							
1.2 TSI	77	03/11→05/16		06/11→; für Linkslenker; +PR 1ZD / 1ZP / 1LV	03.2122-2129.3	010799	ATE Ø 22,2
1.4 TSI	118	03/11→05/16		06/11→; für Linkslenker; +PR 1ZA / 1ZB / 1ZE / 1ZK	03.2123-3449.3	010808	ATE Ø 23,8
1.6 TDI	77	03/11→05/16		06/11→; für Rechtslenker; +PR 1ZD / 1ZP	24.4152-0132.3	011025	ATE Ø 22,2 ohne Bremsflüssigkeitsbehälter
				06/11→; für Rechtslenker; +PR 1ZA / 1ZB / 1ZE / 1ZK	24.4153-0202.3	011027	ATE Ø 23,8 ohne Bremsflüssigkeitsbehälter
1.2 TSI 16V	77	11/13→05/16		für Linkslenker; +PR 1ZD / 1ZP / 1LV	03.2122-2129.3	010799	ATE Ø 22,2
1.4 TSI	90 - 110	11/11→05/16		für Linkslenker; +PR 1ZA / 1ZB / 1ZE / 1ZK	03.2123-3449.3	010808	ATE Ø 23,8
2.0 GTI	155	05/12→05/16		für Rechtslenker; +PR 1ZD / 1ZP	24.4152-0132.3	011025	ATE Ø 22,2 ohne Bremsflüssigkeitsbehälter
2.0 R	195	01/13→05/16					
2.0 TDI	81 - 110	11/11→05/16					
2.0 TSI	162	11/13→05/16		für Rechtslenker; +PR 1ZA / 1ZB / 1ZE / 1ZK	24.4153-0202.3	011027	ATE Ø 23,8 ohne Bremsflüssigkeitsbehälter
VW - GOLF VI Van (5K1_) 10/08→11/12							
 Bremskraftverstärker							
1.2 TSi	63	05/10→11/12		1K-9-400001→; → 11/10; für Linkslenker; +PR 1ZK	03.7860-8802.4	300291	ATE Ø 10" pneumatisch
1.2 TSi BlueMotion	77	05/09→11/12					
1.4 TSi	118	10/08→11/12		für Linkslenker; +PR 1ZD / 1ZF / 1ZP / 1LV	03.7863-3232.4	300307	ATE Ø 10" pneumatisch
1.6 TDi	66	02/09→11/12					
1.6 TDi BlueMotion	77	05/09→11/12		1K-9-400001→; → 11/10; für Linkslenker; +PR 1ZA / 1ZB / 1ZE / 1LJ	03.7863-3332.4	300308	ATE Ø 10" pneumatisch
2.0 GTi	155	02/09→11/12					
2.0 TDi	103 - 125	09/09→11/12		→ 1K-9-200000; für Linkslenker; +PR 1LJ / 1LL / 1LM	03.7863-3332.4	300308	ATE Ø 10" pneumatisch
2.0 TSi R 4motion	199	11/09→11/12					
TSi	90	10/08→11/12					
 Hauptbremszylinder							
1.2 TSi	63	05/10→11/12		für Linkslenker; +PR 1ZD / 1ZF / 1ZP / 1LV	03.2122-2129.3	010799	ATE Ø 22,2
1.2 TSi BlueMotion	77	05/09→11/12					
1.4 TSi	118	10/08→11/12		für Linkslenker; +PR 1ZA / 1ZB / 1ZE / 1LJ	03.2123-3449.3	010808	ATE Ø 23,8
1.6 TDi	66	02/09→11/12					
1.6 TDi BlueMotion	77	05/09→11/12		für Rechtslenker; +PR 1ZD / 1ZF / 1ZP / 1LV	24.4152-0132.3	011025	ATE Ø 22,2 ohne Bremsflüssigkeitsbehälter
2.0 GTi	155	02/09→11/12					
2.0 TDi	103 - 125	09/09→11/12		für Rechtslenker; +PR 1ZA / 1ZB / 1ZE / 1LJ	24.4153-0202.3	011027	ATE Ø 23,8 ohne Bremsflüssigkeitsbehälter
2.0 TSi R 4motion	199	11/09→11/12					
TSi	90	10/08→11/12					
VW - GOLF VI Variant (AJ5) 07/09→07/14							
 Bremskraftverstärker							
1.2 TSI	63	07/10→07/13		für Linkslenker; +PR 1AC / 1AT / 1ZD / 1ZP	03.7863-3232.4	300307	ATE Ø 10" pneumatisch
1.6 MultiFuel	75	07/10→07/13					
1.6 TDI	66	12/09→07/13					
2.0 TDI	81	01/10→07/13					
1.2 TSI	77	07/09→07/13		12/09→; für Linkslenker; +PR 1ZD / 1ZP	03.7863-3232.4	300307	ATE Ø 10" pneumatisch
1.4	59	07/09→07/13					
1.4 TSI	90 - 118	07/09→07/13		+PR 1AC / 1AT; → 11/09; für Linkslenker	03.7863-3332.4	300308	ATE Ø 10" pneumatisch
1.6	75	07/09→07/13					
1.6 BiFuel	75	07/09→12/10					
1.6 TDI	77	07/09→07/13					
1.6 TDI 4motion	77	07/09→07/13					
2.0 TDI	100 - 103	07/09→07/13					
2.0 TFSI	147	07/09→07/13					
 Hauptbremszylinder							
1.2 TSI	63	07/10→07/13		für Linkslenker; +PR 1ZD / 1ZP	03.2122-2129.3	010799	ATE Ø 22,2

	kw					! #		
VW - GOLF VI Variant (AJ5) 07/09→07/14								
 Hauptbremszylinder								
1.6 MultiFuel	75	07/10→07/13		+PR 1ZD / 1ZP; für Rechtslenker		24.4152-0132.3	011025	ATE Ø 22,2 ohne Bremsflüssigkeitsbehälter
				+PR 1LJ / 1ZA / 1ZE; für Rechtslenker		24.4153-0202.3	011027	ATE Ø 23,8 ohne Bremsflüssigkeitsbehälter
1.2 TSI	77	07/09→07/13		12/09→; für Linkslenker; +PR 1ZD / 1ZP		03.2122-2129.3	010799	ATE Ø 22,2
1.4	59	07/09→07/13		→ 11/09; für Linkslenker; +PR 1AC / 1AT		03.2122-2129.3	010799	ATE Ø 22,2
1.4 TSI	90 - 118	07/09→07/13		→ 11/09; +PR 1LJ / 1LL		03.2123-3449.3	010808	ATE Ø 23,8
1.6	75	07/09→07/13		→ 11/09; für Rechtslenker		24.4152-0132.3	011025	ATE Ø 22,2 ohne Bremsflüssigkeitsbehälter
1.6 BiFuel	75	07/09→12/10						
1.6 TDI	77	07/09→07/13		12/09→; +PR 1ZD / 1ZP; für Rechtslenker		24.4152-0132.3	011025	ATE Ø 22,2 ohne Bremsflüssigkeitsbehälter
1.6 TDI 4motion	77	07/09→07/13						
2.0 TDI	100 - 103	07/09→07/13		→ 11/09; +PR 1LJ / 1LL; für Rechtslenker		24.4153-0202.3	011027	ATE Ø 23,8 ohne Bremsflüssigkeitsbehälter
2.0 TFSI	147	07/09→07/13		12/09→; +PR 1LJ / 1ZA / 1ZE; für Rechtslenker		24.4153-0202.3	011027	ATE Ø 23,8 ohne Bremsflüssigkeitsbehälter
1.6 TDI	66	12/09→07/13		für Linkslenker; +PR 1ZD / 1ZP		03.2122-2129.3	010799	ATE Ø 22,2
				+PR 1LJ / 1LL; für Linkslenker		03.2123-3449.3	010808	ATE Ø 23,8
				+PR 1ZD / 1ZP; für Rechtslenker		24.4152-0132.3	011025	ATE Ø 22,2 ohne Bremsflüssigkeitsbehälter
				+PR 1LJ / 1ZA / 1ZE; für Rechtslenker		24.4153-0202.3	011027	ATE Ø 23,8 ohne Bremsflüssigkeitsbehälter
2.0 TDI	81	01/10→07/13		für Linkslenker; +PR 1AC / 1AT / 1ZD / 1ZP		03.2122-2129.3	010799	ATE Ø 22,2
				+PR 1ZD / 1ZP; für Rechtslenker		24.4152-0132.3	011025	ATE Ø 22,2 ohne Bremsflüssigkeitsbehälter
				+PR 1LJ / 1ZA / 1ZE / 1LL; für Rechtslenker		24.4153-0202.3	011027	ATE Ø 23,8 ohne Bremsflüssigkeitsbehälter
VW - GOLF VII (5G1, BQ1, BE1, BE2) 08/12→03/21								
 Hauptbremszylinder								
1.0 TSI	63 - 85	05/15→08/20		für Linkslenker; +PR 1ZA / 1ZD / 1ZE / 1ZF / 1ZP		03.4153-5403.3	010994	ATE Ø 23,8
1.2 TSI	77 - 81	11/12→03/17				24.4123-1719.3	011017	TRW Ø 23,8 ohne Bremsflüssigkeitsbehälter
1.4 TSI	92 - 110	05/14→03/21						
1.4 TSI MultiFuel	90 - 92	11/12→07/18						
1.5 TGI	96	11/18→08/20						
1.5 TSI	96 - 110	04/17→08/20						
1.6	81	05/14→07/17						
1.6 TDI	66 - 85	04/13→08/20						
1.6 TDI 4motion	77 - 81	11/12→03/17						
2.0 GTD	135	04/13→08/20						
2.0 GTI	155 - 180	04/13→08/20						
2.0 GTI Clubsport	195	02/16→03/17						
2.0 GTI Clubsport S	228	09/16→03/17						
2.0 GTI TCR	213	11/18→08/20						
2.0 R 360S 4motion	265	09/16→03/17						
2.0 R 4motion	206 - 228	11/13→08/20						
2.0 TDI	81 - 110	08/12→08/20						
2.0 TDI 4motion	110	11/12→08/20						
1.2 TSI	63	08/12→03/17		11/12→; für Linkslenker; +PR 1ZA / 1ZD / 1ZE / 1ZF / 1ZP		03.4153-5403.3	010994	ATE Ø 23,8
1.4 TSI	103	08/12→07/17				24.4123-1719.3	011017	TRW Ø 23,8 ohne Bremsflüssigkeitsbehälter
1.6 TDI	77	08/12→03/17						
1.4 TGI CNG	81	06/13→07/18		08/13→; für Linkslenker; +PR 1ZA / 1ZD / 1ZE / 1ZF / 1ZP		03.4153-5403.3	010994	ATE Ø 23,8
						24.4123-1719.3	011017	TRW Ø 23,8 ohne Bremsflüssigkeitsbehälter
1.4 TSI	90	11/12→03/17		06/13→; für Linkslenker; +PR 1ZA / 1ZD / 1ZE / 1ZF / 1ZP		03.4153-5403.3	010994	ATE Ø 23,8
1.6 TDI	81	01/13→03/17				24.4123-1719.3	011017	TRW Ø 23,8 ohne Bremsflüssigkeitsbehälter
VW - GOLF VII Van (5G1) 08/12→03/17								
 Hauptbremszylinder								
1.2 TSi BlueMotion	63	08/12→03/17		11/12→; für Linkslenker; +PR 1ZA / 1ZD / 1ZE / 1ZF / 1ZP		03.4153-5403.3	010994	ATE Ø 23,8
1.4 TSi BlueMotion	103	08/12→03/17						
→								

	kw					! #			
VW - GOLF VII Van (5G1) 08/12→03/17									
 Hauptbremszylinder									
1.6 TDi BlueMotion	77	08/12→03/17		11/12→; für Linkslenker; +PR 1ZA / 1ZD / 1ZE / 1ZF / 1ZP		24.4123-1719.3	011017	TRW Ø 23,8 ohne Bremsflüssigkeitsbehälter	
1.2 TSi BlueMotion	77	11/12→03/17		für Linkslenker; +PR 1ZA / 1ZD / 1ZE / 1ZF / 1ZP		03.4153-5403.3	010994	ATE Ø 23,8	
1.4 TSi BlueMotion	90	05/13→03/17				24.4123-1719.3	011017	TRW Ø 23,8 ohne Bremsflüssigkeitsbehälter	
1.6 TDi BlueMotion	66 - 81	04/13→03/17							
2.0 GTD	135	04/13→03/17							
2.0 GTI	162 - 169	04/13→03/17							
2.0 TDi BlueMotion	110	05/13→05/14							
2.0 TDi BlueMotion 4motion	110	05/13→05/14							
VW - GOLF VII Variant (BA5, BV5) 04/13→01/22									
 Hauptbremszylinder									
1.0 TSI	63 - 85	05/15→08/20		für Linkslenker; +PR 1ZA / 1ZD / 1ZE / 1ZF / 1ZP		03.4153-5403.3	010994	ATE Ø 23,8	
1.2 TSI	81	04/14→03/17				24.4123-1719.3	011017	TRW Ø 23,8 ohne Bremsflüssigkeitsbehälter	
1.4 TSI	92 - 110	05/14→03/21				24.4153-1522.3	011048	ATE Ø 23,8 ohne Bremsflüssigkeitsbehälter	
1.4 TSI MultiFuel	92	05/14→03/17							
1.5 TSI	96 - 110	04/17→08/20							
1.6	81	05/14→07/17							
1.6 TDI	85	11/16→08/20							
2.0 GTD	135	01/15→07/19							
2.0 R 360S 4motion	265	09/16→03/17							
2.0 R 4motion	206 - 228	03/15→08/20							
1.2 TSI	63 - 77	04/13→08/20		07/13→; für Linkslenker; +PR 1ZA / 1ZD / 1ZE / 1ZF / 1ZP		03.4153-5403.3	010994	ATE Ø 23,8	
1.4 TSI	90 - 103	05/13→08/20				24.4123-1719.3	011017	TRW Ø 23,8 ohne Bremsflüssigkeitsbehälter	
1.6 TDI	66 - 81	05/13→07/18		12/13→; für Linkslenker; +PR 1ZA / 1ZD / 1ZE / 1ZF / 1ZP		24.4153-1522.3	011048	ATE Ø 23,8 ohne Bremsflüssigkeitsbehälter	
1.6 TDI 4motion	77 - 81	05/13→03/17							
2.0 TDI	81 - 110	04/13→08/20							
2.0 TDI 4motion	110	04/13→08/20							
1.4 TGI CNG	81	09/13→07/18		für Linkslenker; +PR 1ZA / 1ZD / 1ZE / 1ZF / 1ZP		03.4153-5403.3	010994	ATE Ø 23,8	
1.4 TSI MultiFuel	90	04/13→03/17				24.4123-1719.3	011017	TRW Ø 23,8 ohne Bremsflüssigkeitsbehälter	
				12/13→; für Linkslenker; +PR 1ZA / 1ZD / 1ZE / 1ZF / 1ZP		24.4153-1522.3	011048	ATE Ø 23,8 ohne Bremsflüssigkeitsbehälter	
1.5 TGI	96	12/18→08/20		für Linkslenker; +PR 1ZA / 1ZD / 1ZE / 1ZF / 1ZP		03.4153-5403.3	010994	ATE Ø 23,8	
						24.4123-1719.3	011017	TRW Ø 23,8 ohne Bremsflüssigkeitsbehälter	
VW - GOLF ALLTRACK VII Variant (BA5, BV5) 12/14→12/20									
 Hauptbremszylinder									
1.6 TDI 4motion	81	12/14→03/17		+PR 1ZA / 1ZD / 1ZE / 1ZF / 1ZP		24.4123-1719.3	011017	TRW Ø 23,8 ohne Bremsflüssigkeitsbehälter	
2.0 TDI 4motion	110 - 135	12/14→08/20				24.4153-1522.3	011048	ATE Ø 23,8 ohne Bremsflüssigkeitsbehälter	
				+PR 1ZA / 1ZD / 1ZE / 1ZF / 1ZP; für Linkslenker					
1.8 TSI 4motion	132	12/14→08/20		für Linkslenker; +PR 1ZA / 1ZD / 1ZE / 1ZF / 1ZP		03.4153-5403.3	010994	ATE Ø 23,8	
						24.4123-1719.3	011017	TRW Ø 23,8 ohne Bremsflüssigkeitsbehälter	
					24.4153-1522.3	011048	ATE Ø 23,8 ohne Bremsflüssigkeitsbehälter		
VW - GOLF Kasten/Schrägheck (1K1) 07/03→									
 Bremskraftverstärker									
TDI	77	11/03→02/06		für Linkslenker; +PR 1AC / 1AT		03.7863-3232.4	300307	ATE Ø 10" pneumatisch	
 Hauptbremszylinder									
TDI	77	11/03→02/06		für Linkslenker; → 1K-6W078889		03.2122-2129.3	010799	ATE Ø 22,2	
				1K-6W078890→; für Linkslenker		03.2122-2129.3	010799	ATE Ø 22,2	
				für Rechtslenker; +PR 1AC / 1AT		24.2122-1981.3	011024	ATE Ø 22,2 ohne Bremsflüssigkeitsbehälter	
				für Rechtslenker; +PR 1AS		24.4152-0132.3	011025	ATE Ø 22,2 ohne Bremsflüssigkeitsbehälter	
→									











	kw			 	! #		
VW - GOLF Kasten/Schrägheck (1K1) 07/03→							
Drucksensor, Bremskraftverstärker							
TDI	77	11/03→02/06		für Linkslenker; +PR 1AS	03.0655-0101.2	370008	ATE
VW - GOLF PLUS V (5M1, 521) 12/04→12/13							
 Bremskraftverstärker							
1.2 TSI	63 - 77	11/09→12/13		1K-9-900001→; → 11/10; für Linkslenker; +PR 1ZK	03.7860-8802.4	300291	ATE Ø 10" pneumatisch
1.6 BiFuel	75	05/09→12/13		12/10→; für Linkslenker; +PR 1ZF / 1AC	03.7863-3232.4	300307	ATE Ø 10" pneumatisch
1.6 TDI	66 - 77	02/09→12/13		1K-9-900001→; → 11/10; für Linkslenker; +PR 1ZD / 1ZF / 1ZP / 1LV	03.7863-3232.4	300307	ATE Ø 10" pneumatisch
2.0 TDI	81	01/09→12/13		12/10→; für Linkslenker; +PR 1ZA / 1ZE / 1AS / 1AT	03.7863-3332.4	300308	ATE Ø 10" pneumatisch
				1K-9-900001→; → 11/10; für Linkslenker; +PR 1ZA / 1ZB / 1ZE	03.7863-3332.4	300308	ATE Ø 10" pneumatisch
1.4 16V	55	01/05→11/06		1K-9-900001→; für Linkslenker; +PR 1ZK	03.7860-8802.4	300291	ATE Ø 10" pneumatisch
1.4 FSI	66	07/05→11/06					
1.4 TSI	103	05/06→06/08		1K-9-900001→; für Linkslenker; +PR 1ZD / 1ZF / 1ZP / 1LV	03.7863-3232.4	300307	ATE Ø 10" pneumatisch
1.6 FSI	85	12/04→05/08					
1.9 TDI	66 - 77	01/05→01/09		+PR 1AC / 1AT; für Linkslenker; → 1K-9-899999	03.7863-3232.4	300307	ATE Ø 10" pneumatisch
2.0 FSI	110	05/05→06/08					
2.0 TDI	96	05/05→05/07		1K-9-900001→; für Linkslenker; +PR 1ZA / 1ZB / 1ZE	03.7863-3332.4	300308	ATE Ø 10" pneumatisch
1.4 16V	59	05/06→12/13		1K-9-900001→; → 11/10; für Linkslenker; +PR 1ZK	03.7860-8802.4	300291	ATE Ø 10" pneumatisch
1.4 TSI	90 - 118	06/07→12/13		12/10→; für Linkslenker; +PR 1ZF / 1AC	03.7863-3232.4	300307	ATE Ø 10" pneumatisch
1.6	75	05/05→12/13					
1.6 MultiFuel	75	11/07→12/13		1K-9-900001→; → 11/10; für Linkslenker; +PR 1ZD / 1ZF / 1ZP / 1LV	03.7863-3232.4	300307	ATE Ø 10" pneumatisch
2.0 TDI	100 - 103	05/05→12/13		+PR 1AC / 1AT; für Linkslenker; → 1K-9-899999	03.7863-3232.4	300307	ATE Ø 10" pneumatisch
2.0 TDI 16V	103	01/05→12/13		12/10→; für Linkslenker; +PR 1ZA / 1ZE / 1AS / 1AT	03.7863-3332.4	300308	ATE Ø 10" pneumatisch
				1K-9-900001→; → 11/10; für Linkslenker; +PR 1ZA / 1ZB / 1ZE	03.7863-3332.4	300308	ATE Ø 10" pneumatisch
1.4 TSI	125	05/06→06/08		1K-9-900001→; für Linkslenker; +PR 1ZK	03.7860-8802.4	300291	ATE Ø 10" pneumatisch
				1K-9-900001→; für Linkslenker; +PR 1ZD / 1ZF / 1ZP / 1LV	03.7863-3232.4	300307	ATE Ø 10" pneumatisch
				+PR 1AC / 1AT; für Linkslenker; → 1K-6-565000	03.7863-3232.4	300307	ATE Ø 10" pneumatisch
				1K-9-900001→; für Linkslenker; +PR 1ZA / 1ZB / 1ZE	03.7863-3332.4	300308	ATE Ø 10" pneumatisch
				1K-6-565001→ 1K-9-899999; für Linkslenker; +PR 1AC / 1AT	03.7863-3332.4	300308	ATE Ø 10" pneumatisch
 Hauptbremszylinder							
1.2 TSI	63 - 77	11/09→12/13		1K-C-500001→; für Linkslenker; +PR 1ZF / 1AC	03.2122-2129.3	010799	ATE Ø 22,2
1.6 BiFuel	75	05/09→12/13		1K-9-900001→; für Linkslenker; → 1K-C-500000; +PR 1ZF	03.2122-2129.3	010799	ATE Ø 22,2
1.6 TDI	66 - 77	02/09→12/13					
2.0 TDI	81	01/09→12/13		1K-C-500001→; für Linkslenker; +PR 1ZA / 1ZE / 1AS / 1AT	03.2123-3449.3	010808	ATE Ø 23,8
				1K-9-900001→; für Linkslenker; → 1K-C-500000; +PR 1ZE / 1LJ / 1ZA	03.2123-3449.3	010808	ATE Ø 23,8
				1K-9-900001→ 1K-C-500000; für Rechtslenker; +PR 1ZF	24.4152-0132.3	011025	ATE Ø 22,2 ohne Bremsflüssigkeitsbehälter
				1K-C-500001→; für Rechtslenker; +PR 1ZF / 1AC	24.4152-0132.3	011025	ATE Ø 22,2 ohne Bremsflüssigkeitsbehälter
				1K-C-500001→; für Rechtslenker; +PR 1ZA / 1ZE / 1AS / 1AT	24.4153-0202.3	011027	ATE Ø 23,8 ohne Bremsflüssigkeitsbehälter
				1K-9-900001→ 1K-C-500000; für Rechtslenker; +PR 1ZE / 1LJ / 1ZA	24.4153-0202.3	011027	ATE Ø 23,8 ohne Bremsflüssigkeitsbehälter
1.4 16V	55 - 59	01/05→12/13		1K-8-500001→ 1K-9-899999; für Linkslenker; +PR 1LK / 1ZA / 1ZC / 1ZD / 1ZE / 1ZF / 1ZM / 1ZP	03.2122-2129.3	010799	ATE Ø 22,2
1.4 FSI	66	07/05→11/06					
1.4 TSI	103	05/06→06/08		1K-9-900001→; für Linkslenker; → 1K-C-500000; +PR 1ZF	03.2122-2129.3	010799	ATE Ø 22,2
1.6	75	05/05→12/13					
1.6 MultiFuel	75	11/07→12/13		→ 1K-6-565000; für Linkslenker	03.2122-2129.3	010799	ATE Ø 22,2
1.9 TDI	66 - 77	01/05→01/09		1K-C-500001→; für Linkslenker; +PR 1ZF / 1AC	03.2122-2129.3	010799	ATE Ø 22,2
2.0 FSI	110	05/05→06/08					
2.0 TDI	96 - 103	05/05→12/13		1K-6-565001→; für Linkslenker; → 1K-8-500000; +PR 1AC / 1AT / 1AS	03.2122-2129.3	010799	ATE Ø 22,2
2.0 TDI 16V	103	01/05→12/13		1K-9-900001→; für Linkslenker; → 1K-C-500000; +PR 1ZE / 1LJ / 1ZA	03.2123-3449.3	010808	ATE Ø 23,8
→							







	kw			 	! #		
VW - GOLF PLUS V (5M1, 521) 12/04→12/13							
Hauptbremszylinder							
1.4 16V	55 - 59	01/05→12/13		1K-C-500001→; für Linkslenker; +PR 1ZA / 1ZE / 1AS / 1AT	03.2123-3449.3	010808	ATE Ø 23,8
1.4 FSI	66	07/05→11/06		1K-8-500001→ 1K-9-899999; für Linkslenker; +PR 1LJ	03.2123-3449.3	010808	ATE Ø 23,8
1.4 TSI	103	05/06→06/08					
1.6	75	05/05→12/13		1K-6-565001→; für Linkslenker; →	03.2123-3449.3	010808	ATE Ø 23,8
1.6 MultiFuel	75	11/07→12/13		1K-8-500000; +PR 1LJ			
1.9 TDI	66 - 77	01/05→01/09		→ 1K-6-565000; für Rechtslenker	24.2122-1981.3	011024	ATE Ø 22,2 ohne Bremsflüssigkeitsbehälter
2.0 FSI	110	05/05→06/08					
2.0 TDI	96 - 103	05/05→12/13		1K-C-500001→; für Rechtslenker; +PR 1ZF / 1AC	24.4152-0132.3	011025	ATE Ø 22,2 ohne Bremsflüssigkeitsbehälter
2.0 TDI 16V	103	01/05→12/13		1K-8-500001→ 1K-9-899999; für Rechtslenker; +PR 1LK / 1ZA / 1ZC / 1ZD / 1ZE / 1ZF / 1ZM / 1ZP	24.4152-0132.3	011025	ATE Ø 22,2 ohne Bremsflüssigkeitsbehälter
				1K-9-900001→ 1K-C-500000; für Rechtslenker; +PR 1ZF	24.4152-0132.3	011025	ATE Ø 22,2 ohne Bremsflüssigkeitsbehälter
				1K-6-565001→; für Rechtslenker; → 1K-8-500000; +PR 1AC / 1AT / 1AS	24.4152-0132.3	011025	ATE Ø 22,2 ohne Bremsflüssigkeitsbehälter
				1K-9-900001→ 1K-C-500000; für Rechtslenker; +PR 1ZE / 1LJ / 1ZA	24.4153-0202.3	011027	ATE Ø 23,8 ohne Bremsflüssigkeitsbehälter
				1K-8-500001→ 1K-9-899999; für Rechtslenker; +PR 1LJ	24.4153-0202.3	011027	ATE Ø 23,8 ohne Bremsflüssigkeitsbehälter
				1K-C-500001→; für Rechtslenker; +PR 1ZA / 1ZE / 1AS / 1AT	24.4153-0202.3	011027	ATE Ø 23,8 ohne Bremsflüssigkeitsbehälter
1.4 TSI	90	06/07→12/13		1K-9-900001→; für Linkslenker; → 1K-C-500000; +PR 1ZF	03.2122-2129.3	010799	ATE Ø 22,2
				1K-C-500001→; für Linkslenker; +PR 1ZF / 1AC	03.2122-2129.3	010799	ATE Ø 22,2
				1K-8-500001→ 1K-9-899999; für Linkslenker; +PR 1LK / 1ZA / 1ZC / 1ZD / 1ZE / 1ZF / 1ZM / 1ZP	03.2122-2129.3	010799	ATE Ø 22,2
				1K-6-565001→; für Linkslenker; → 1K-8-500000; +PR 1AC / 1AT / 1AS	03.2122-2129.3	010799	ATE Ø 22,2
				1K-C-500001→; für Linkslenker; +PR 1ZA / 1ZE / 1AS / 1AT	03.2123-3449.3	010808	ATE Ø 23,8
				1K-9-900001→; für Linkslenker; → 1K-C-500000; +PR 1ZE / 1LJ / 1ZA	03.2123-3449.3	010808	ATE Ø 23,8
				1K-8-500001→ 1K-9-899999; für Linkslenker; +PR 1LJ	03.2123-3449.3	010808	ATE Ø 23,8
				1K-6-565001→; für Linkslenker; → 1K-8-500000; +PR 1LJ	03.2123-3449.3	010808	ATE Ø 23,8
				1K-C-500001→; für Rechtslenker; +PR 1ZF / 1AC	24.4152-0132.3	011025	ATE Ø 22,2 ohne Bremsflüssigkeitsbehälter
				1K-9-900001→ 1K-C-500000; für Rechtslenker; +PR 1ZF	24.4152-0132.3	011025	ATE Ø 22,2 ohne Bremsflüssigkeitsbehälter
				1K-8-500001→ 1K-9-899999; für Rechtslenker; +PR 1LK / 1ZA / 1ZC / 1ZD / 1ZE / 1ZF / 1ZM / 1ZP	24.4152-0132.3	011025	ATE Ø 22,2 ohne Bremsflüssigkeitsbehälter
				1K-6-565001→; für Rechtslenker; → 1K-8-500000; +PR 1AC / 1AT / 1AS	24.4152-0132.3	011025	ATE Ø 22,2 ohne Bremsflüssigkeitsbehälter
				1K-C-500001→; für Rechtslenker; +PR 1ZA / 1ZE / 1AS / 1AT	24.4153-0202.3	011027	ATE Ø 23,8 ohne Bremsflüssigkeitsbehälter
				1K-9-900001→ 1K-C-500000; für Rechtslenker; +PR 1ZE / 1LJ / 1ZA	24.4153-0202.3	011027	ATE Ø 23,8 ohne Bremsflüssigkeitsbehälter
				1K-8-500001→ 1K-9-899999; für Rechtslenker; +PR 1LJ	24.4153-0202.3	011027	ATE Ø 23,8 ohne Bremsflüssigkeitsbehälter
1.4 TSI	118	06/08→12/13		1K-C-500001→; für Linkslenker; +PR 1ZF / 1AC	03.2122-2129.3	010799	ATE Ø 22,2
				1K-8-500001→ 1K-9-899999; für Linkslenker; +PR 1LK / 1ZA / 1ZC / 1ZD / 1ZE / 1ZF / 1ZM / 1ZP	03.2122-2129.3	010799	ATE Ø 22,2
				1K-9-900001→; für Linkslenker; → 1K-C-500000; +PR 1ZF	03.2122-2129.3	010799	ATE Ø 22,2
				1K-C-500001→; für Linkslenker; +PR 1ZA / 1ZE / 1AS / 1AT	03.2123-3449.3	010808	ATE Ø 23,8
				1K-8-500001→ 1K-9-899999; für Linkslenker; +PR 1LJ	03.2123-3449.3	010808	ATE Ø 23,8
				1K-9-900001→; für Linkslenker; → 1K-C-500000; +PR 1ZE / 1LJ / 1ZA	03.2123-3449.3	010808	ATE Ø 23,8
				1K-C-500001→; für Rechtslenker; +PR 1ZF / 1AC	24.4152-0132.3	011025	ATE Ø 22,2 ohne Bremsflüssigkeitsbehälter
				1K-9-900001→ 1K-C-500000; für Rechtslenker; +PR 1ZF	24.4152-0132.3	011025	ATE Ø 22,2 ohne Bremsflüssigkeitsbehälter

	kw			 	! #		
VW - GOLF PLUS V (5M1, 521) 12/04→12/13							
Hauptbremszylinder							
1.4 TSI	118	06/08→12/13		1K-8-500001→ 1K-9-899999; für Rechtslenker; +PR 1LK / 1ZA / 1ZC / 1ZD / 1ZE / 1ZF / 1ZM / 1ZP	24.4152-0132.3	011025	ATE Ø 22,2 ohne Bremsflüssigkeitsbehälter
				1K-C-500001→; für Rechtslenker; +PR 1ZA / 1ZE / 1AS / 1AT	24.4153-0202.3	011027	ATE Ø 23,8 ohne Bremsflüssigkeitsbehälter
				1K-8-500001→ 1K-9-899999; für Rechtslenker; +PR 1LJ	24.4153-0202.3	011027	ATE Ø 23,8 ohne Bremsflüssigkeitsbehälter
				1K-9-900001→ 1K-C-500000; für Rechtslenker; +PR 1ZE / 1LJ / 1ZA	24.4153-0202.3	011027	ATE Ø 23,8 ohne Bremsflüssigkeitsbehälter
1.4 TSI	125	05/06→06/08		1K-9-900001→; für Linkslenker; → 1K-C-500000; +PR 1ZF	03.2122-2129.3	010799	ATE Ø 22,2
				→ 1K-6-565000; für Linkslenker	03.2122-2129.3	010799	ATE Ø 22,2
				1K-8-500001→ 1K-9-899999; für Linkslenker; +PR 1LK / 1ZA / 1ZC / 1ZD / 1ZE / 1ZF / 1ZM / 1ZP	03.2122-2129.3	010799	ATE Ø 22,2
				1K-C-500001→; für Linkslenker; +PR 1ZF / 1AC	03.2122-2129.3	010799	ATE Ø 22,2
				1K-6-565001→; für Linkslenker; → 1K-8-500000; +PR 1AC / 1AT / 1AS	03.2122-2129.3	010799	ATE Ø 22,2
				1K-C-500001→; für Linkslenker; +PR 1ZA / 1ZE / 1AS / 1AT	03.2123-3449.3	010808	ATE Ø 23,8
				1K-9-900001→; für Linkslenker; → 1K-C-500000; +PR 1ZE / 1LJ / 1ZA	03.2123-3449.3	010808	ATE Ø 23,8
				1K-8-500001→ 1K-9-899999; für Linkslenker; +PR 1LJ	03.2123-3449.3	010808	ATE Ø 23,8
				1K-6-565001→; für Linkslenker; → 1K-8-500000; +PR 1LJ	03.2123-3449.3	010808	ATE Ø 23,8
				→ 1K-7-550000; für Rechtslenker	24.2122-1981.3	011024	ATE Ø 22,2 ohne Bremsflüssigkeitsbehälter
				1K-C-500001→; für Rechtslenker; +PR 1ZF / 1AC	24.4152-0132.3	011025	ATE Ø 22,2 ohne Bremsflüssigkeitsbehälter
				1K-8-500001→ 1K-9-899999; für Rechtslenker; +PR 1LK / 1ZA / 1ZC / 1ZD / 1ZE / 1ZF / 1ZM / 1ZP	24.4152-0132.3	011025	ATE Ø 22,2 ohne Bremsflüssigkeitsbehälter
				1K-9-900001→ 1K-C-500000; für Rechtslenker; +PR 1ZF	24.4152-0132.3	011025	ATE Ø 22,2 ohne Bremsflüssigkeitsbehälter
				1K-8-500001→ 1K-9-899999; für Rechtslenker; +PR 1LJ	24.4153-0202.3	011027	ATE Ø 23,8 ohne Bremsflüssigkeitsbehälter
				1K-7-550001→; für Rechtslenker; → 1K-8-500000; +PR 1AC / 1AT / 1AS / 1LJ	24.4153-0202.3	011027	ATE Ø 23,8 ohne Bremsflüssigkeitsbehälter
				1K-9-900001→ 1K-C-500000; für Rechtslenker; +PR 1ZE / 1LJ / 1ZA	24.4153-0202.3	011027	ATE Ø 23,8 ohne Bremsflüssigkeitsbehälter
	1K-C-500001→; für Rechtslenker; +PR 1ZA / 1ZE / 1AS / 1AT	24.4153-0202.3	011027	ATE Ø 23,8 ohne Bremsflüssigkeitsbehälter			
1.6 FSI	85	12/04→05/08		1K-C-500001→; für Linkslenker; +PR 1ZF / 1AC	03.2122-2129.3	010799	ATE Ø 22,2
				→ 1K-6-565000; für Linkslenker	03.2122-2129.3	010799	ATE Ø 22,2
				1K-8-500001→ 1K-9-899999; für Linkslenker; +PR 1LK / 1ZA / 1ZC / 1ZD / 1ZE / 1ZF / 1ZM / 1ZP	03.2122-2129.3	010799	ATE Ø 22,2
				1K-9-900001→; für Linkslenker; → 1K-C-500000; +PR 1ZF	03.2122-2129.3	010799	ATE Ø 22,2
				1K-6-565001→; für Linkslenker; → 1K-8-500000; +PR 1AC / 1AT / 1AS	03.2122-2129.3	010799	ATE Ø 22,2
				1K-C-500001→; für Linkslenker; +PR 1ZA / 1ZE / 1AS / 1AT	03.2123-3449.3	010808	ATE Ø 23,8
				1K-6-565001→; für Linkslenker; → 1K-8-500000; +PR 1LJ	03.2123-3449.3	010808	ATE Ø 23,8
				1K-8-500001→ 1K-9-899999; für Linkslenker; +PR 1LJ	03.2123-3449.3	010808	ATE Ø 23,8
				1K-9-900001→; für Linkslenker; → 1K-C-500000; +PR 1ZE / 1LJ / 1ZA	03.2123-3449.3	010808	ATE Ø 23,8
				01/05→; für Rechtslenker; → 1K-6-565000	24.2122-1981.3	011024	ATE Ø 22,2 ohne Bremsflüssigkeitsbehälter
				1K-C-500001→; für Rechtslenker; +PR 1ZF / 1AC	24.4152-0132.3	011025	ATE Ø 22,2 ohne Bremsflüssigkeitsbehälter
				1K-9-900001→ 1K-C-500000; für Rechtslenker; +PR 1ZF	24.4152-0132.3	011025	ATE Ø 22,2 ohne Bremsflüssigkeitsbehälter
				1K-8-500001→ 1K-9-899999; für Rechtslenker; +PR 1LK / 1ZA / 1ZC / 1ZD / 1ZE / 1ZF / 1ZM / 1ZP	24.4152-0132.3	011025	ATE Ø 22,2 ohne Bremsflüssigkeitsbehälter
				1K-6-565001→; für Rechtslenker; → 1K-8-500000; +PR 1AC / 1AT / 1AS	24.4152-0132.3	011025	ATE Ø 22,2 ohne Bremsflüssigkeitsbehälter











→



























	kw					! #		
VW - GOLF PLUS V (5M1, 521) 12/04→12/13								
 Hauptbremszylinder								
1.6 FSI	85	12/04→05/08		1K-9-900001→ 1K-C-500000; für Rechtslenker; +PR 1ZE / 1LJ / 1ZA		24.4153-0202.3	011027	ATE Ø 23,8 ohne Bremsflüssigkeitsbehälter
				1K-C-500001→; für Rechtslenker; +PR 1ZA / 1ZE / 1AS / 1AT		24.4153-0202.3	011027	ATE Ø 23,8 ohne Bremsflüssigkeitsbehälter
				1K-8-500001→ 1K-9-899999; für Rechtslenker; +PR 1LJ		24.4153-0202.3	011027	ATE Ø 23,8 ohne Bremsflüssigkeitsbehälter
Drucksensor, Bremskraftverstärker								
1.4 16V	55 - 59	01/05→12/13		1K-6-565001→ 1K-9-899999; für Rechtslenker; +PR 1AS		03.0655-0101.2	370008	ATE
1.4 FSI	66	07/05→11/06		+PR 1AS; für Linkslenker; → 1K-9-899999		03.0655-0101.2	370008	ATE
1.4 TSI	90 - 118	05/06→12/13						
1.6	75	05/05→12/13						
1.6 FSI	85	12/04→05/08						
1.6 MultiFuel	75	11/07→12/13						
1.9 TDI	66 - 77	01/05→01/09						
2.0 FSI	110	05/05→06/08						
2.0 TDI	96 - 103	05/05→12/13						
2.0 TDI 16V	103	01/05→12/13						
1.4 TSI	125	05/06→06/08		1K-6-565001→ 1K-9-899999; für Rechtslenker; +PR 1AC / 1AT / 1AS		03.0655-0101.2	370008	ATE
				+PR 1AS; für Linkslenker; → 1K-6-565000		03.0655-0101.2	370008	ATE
VW - GOLF PLUS Van (521) 01/09→08/14								
 Bremskraftverstärker								
1.2 TSi	77	11/09→08/14		1K-9-900001→; für Linkslenker; → 11/10; +PR 1ZK		03.7860-8802.4	300291	ATE Ø 10" pneumatisch
1.6 TDi	66 - 77	02/09→08/14		12/10→; für Linkslenker; +PR 1ZF / 1AC		03.7863-3232.4	300307	ATE Ø 10" pneumatisch
				1K-9-900001→; für Linkslenker; → 11/10; +PR 1ZD / 1ZF / 1ZP / 1LV		03.7863-3232.4	300307	ATE Ø 10" pneumatisch
				12/10→; für Linkslenker; +PR 1ZA / 1ZE / 1AS / 1AT		03.7863-3332.4	300308	ATE Ø 10" pneumatisch
				1K-9-900001→; für Linkslenker; → 11/10; +PR 1ZA / 1ZB / 1ZE		03.7863-3332.4	300308	ATE Ø 10" pneumatisch
1.4 TSi	90 - 118	01/09→08/14		1K-9-900001→; für Linkslenker; → 11/10; +PR 1ZK		03.7860-8802.4	300291	ATE Ø 10" pneumatisch
2.0 TDi	103	11/09→08/14		12/10→; für Linkslenker; +PR 1ZF / 1AC		03.7863-3232.4	300307	ATE Ø 10" pneumatisch
				1K-9-900001→; für Linkslenker; → 11/10; +PR 1ZD / 1ZF / 1ZP / 1LV		03.7863-3232.4	300307	ATE Ø 10" pneumatisch
				+PR 1AC / 1AT; für Linkslenker; → 1K-9-899999		03.7863-3232.4	300307	ATE Ø 10" pneumatisch
				12/10→; für Linkslenker; +PR 1ZA / 1ZE / 1AS / 1AT		03.7863-3332.4	300308	ATE Ø 10" pneumatisch
				1K-9-900001→; für Linkslenker; → 11/10; +PR 1ZA / 1ZB / 1ZE		03.7863-3332.4	300308	ATE Ø 10" pneumatisch
 Hauptbremszylinder								
1.2 TSi	77	11/09→08/14		1K-C-500001→; für Linkslenker; +PR 1ZF / 1AC		03.2122-2129.3	010799	ATE Ø 22,2
1.6 TDi	66 - 77	02/09→08/14		1K-9-900001→; für Linkslenker; → 1K-C-500000; +PR 1ZF		03.2122-2129.3	010799	ATE Ø 22,2
				1K-C-500001→; für Linkslenker; +PR 1ZA / 1ZE / 1AS / 1AT		03.2123-3449.3	010808	ATE Ø 23,8
				1K-9-900001→; für Linkslenker; → 1K-C-500000; +PR 1ZE / 1LJ / 1ZA		03.2123-3449.3	010808	ATE Ø 23,8
				1K-9-900001→; für Rechtslenker; → 1K-C-500000; +PR 1ZF		24.4152-0132.3	011025	ATE Ø 22,2 ohne Bremsflüssigkeitsbehälter
				1K-C-500001→; für Rechtslenker; +PR 1ZF / 1AC		24.4152-0132.3	011025	ATE Ø 22,2 ohne Bremsflüssigkeitsbehälter
				1K-C-500001→; für Rechtslenker; +PR 1ZA / 1ZE / 1AS / 1AT		24.4153-0202.3	011027	ATE Ø 23,8 ohne Bremsflüssigkeitsbehälter
				1K-9-900001→; für Rechtslenker; → 1K-C-500000; +PR 1ZE / 1LJ / 1ZA		24.4153-0202.3	011027	ATE Ø 23,8 ohne Bremsflüssigkeitsbehälter
1.4 TSi	90	01/09→08/14		1K-9-900001→; für Linkslenker; → 1K-C-500000; +PR 1ZF		03.2122-2129.3	010799	ATE Ø 22,2
				1K-6-565001→; für Linkslenker; → 1K-8-500000; +PR 1AC / 1AT / 1AS		03.2122-2129.3	010799	ATE Ø 22,2
				1K-C-500001→; für Linkslenker; +PR 1ZF / 1AC		03.2122-2129.3	010799	ATE Ø 22,2
→								













	kw			 	! #		
VW - GOLF PLUS Van (521) 01/09→08/14							
Hauptbremszylinder							
1.4 Tsi	90	01/09→08/14		1K-8-500001→; für Linkslenker; → 1K-9-899999; +PR 1LK / 1ZA / 1ZC / 1ZD / 1ZE / 1ZF / 1ZM / 1ZP	03.2122-2129.3	010799	ATE Ø 22,2
				1K-6-565001→; für Linkslenker; → 1K-8-500000; +PR 1LJ	03.2123-3449.3	010808	ATE Ø 23,8
				1K-C-500001→; für Linkslenker; +PR 1ZA / 1ZE / 1AS / 1AT	03.2123-3449.3	010808	ATE Ø 23,8
				1K-9-900001→; für Linkslenker; → 1K-C-500000; +PR 1ZE / 1LJ / 1ZA	03.2123-3449.3	010808	ATE Ø 23,8
				1K-8-500001→; für Linkslenker; → 1K-9-899999; +PR 1LJ	03.2123-3449.3	010808	ATE Ø 23,8
				1K-C-500001→; für Rechtslenker; +PR 1ZF / 1AC	24.4152-0132.3	011025	ATE Ø 22,2 ohne Bremsflüssigkeitsbehälter
				1K-6-565001→; für Rechtslenker; → 1K-8-500000; +PR 1AC / 1AT / 1AS	24.4152-0132.3	011025	ATE Ø 22,2 ohne Bremsflüssigkeitsbehälter
				1K-9-900001→; für Rechtslenker; → 1K-C-500000; +PR 1ZF	24.4152-0132.3	011025	ATE Ø 22,2 ohne Bremsflüssigkeitsbehälter
				1K-8-500001→; für Rechtslenker; → 1K-9-899999; +PR 1LK / 1ZA / 1ZC / 1ZD / 1ZE / 1ZF / 1ZM / 1ZP	24.4152-0132.3	011025	ATE Ø 22,2 ohne Bremsflüssigkeitsbehälter
				1K-C-500001→; für Rechtslenker; +PR 1ZA / 1ZE / 1AS / 1AT	24.4153-0202.3	011027	ATE Ø 23,8 ohne Bremsflüssigkeitsbehälter
				1K-8-500001→; für Rechtslenker; → 1K-9-899999; +PR 1LJ	24.4153-0202.3	011027	ATE Ø 23,8 ohne Bremsflüssigkeitsbehälter
				1K-9-900001→; für Rechtslenker; → 1K-C-500000; +PR 1ZE / 1LJ / 1ZA	24.4153-0202.3	011027	ATE Ø 23,8 ohne Bremsflüssigkeitsbehälter
1.4 Tsi	118	01/09→09/12		1K-C-500001→; für Linkslenker; +PR 1ZF / 1AC	03.2122-2129.3	010799	ATE Ø 22,2
				1K-9-900001→; für Linkslenker; → 1K-C-500000; +PR 1ZF	03.2122-2129.3	010799	ATE Ø 22,2
				1K-8-500001→; für Linkslenker; → 1K-9-899999; +PR 1LK / 1ZA / 1ZC / 1ZD / 1ZE / 1ZF / 1ZM / 1ZP	03.2122-2129.3	010799	ATE Ø 22,2
				1K-C-500001→; für Linkslenker; +PR 1ZA / 1ZE / 1AS / 1AT	03.2123-3449.3	010808	ATE Ø 23,8
				1K-9-900001→; für Linkslenker; → 1K-C-500000; +PR 1ZE / 1LJ / 1ZA	03.2123-3449.3	010808	ATE Ø 23,8
				1K-8-500001→; für Linkslenker; → 1K-9-899999; +PR 1LJ	03.2123-3449.3	010808	ATE Ø 23,8
				1K-C-500001→; für Rechtslenker; +PR 1ZF / 1AC	24.4152-0132.3	011025	ATE Ø 22,2 ohne Bremsflüssigkeitsbehälter
				1K-8-500001→; für Rechtslenker; → 1K-9-899999; +PR 1LK / 1ZA / 1ZC / 1ZD / 1ZE / 1ZF / 1ZM / 1ZP	24.4152-0132.3	011025	ATE Ø 22,2 ohne Bremsflüssigkeitsbehälter
				1K-9-900001→; für Rechtslenker; → 1K-C-500000; +PR 1ZF	24.4152-0132.3	011025	ATE Ø 22,2 ohne Bremsflüssigkeitsbehälter
				1K-C-500001→; für Rechtslenker; +PR 1ZA / 1ZE / 1AS / 1AT	24.4153-0202.3	011027	ATE Ø 23,8 ohne Bremsflüssigkeitsbehälter
				1K-9-900001→; für Rechtslenker; → 1K-C-500000; +PR 1ZE / 1LJ / 1ZA	24.4153-0202.3	011027	ATE Ø 23,8 ohne Bremsflüssigkeitsbehälter
				1K-8-500001→; für Rechtslenker; → 1K-9-899999; +PR 1LJ	24.4153-0202.3	011027	ATE Ø 23,8 ohne Bremsflüssigkeitsbehälter
2.0 TDi	103	11/09→08/14		1K-6-565001→; für Linkslenker; → 1K-8-500000; +PR 1AC / 1AT / 1AS	03.2122-2129.3	010799	ATE Ø 22,2
				für Linkslenker; → 1K-6-565000	03.2122-2129.3	010799	ATE Ø 22,2
				1K-9-900001→; für Linkslenker; → 1K-C-500000; +PR 1ZF	03.2122-2129.3	010799	ATE Ø 22,2
				1K-C-500001→; für Linkslenker; +PR 1ZF / 1AC	03.2122-2129.3	010799	ATE Ø 22,2
				1K-8-500001→; für Linkslenker; → 1K-9-899999; +PR 1LK / 1ZA / 1ZC / 1ZD / 1ZE / 1ZF / 1ZM / 1ZP	03.2122-2129.3	010799	ATE Ø 22,2
				1K-C-500001→; für Linkslenker; +PR 1ZA / 1ZE / 1AS / 1AT	03.2123-3449.3	010808	ATE Ø 23,8
				1K-8-500001→; für Linkslenker; → 1K-9-899999; +PR 1LJ	03.2123-3449.3	010808	ATE Ø 23,8
				1K-9-900001→; für Linkslenker; → 1K-C-500000; +PR 1ZE / 1LJ / 1ZA	03.2123-3449.3	010808	ATE Ø 23,8
				1K-6-565001→; für Linkslenker; → 1K-8-500000; +PR 1LJ	03.2123-3449.3	010808	ATE Ø 23,8
				für Rechtslenker; → 1K-6-565000	24.2122-1981.3	011024	ATE Ø 22,2 ohne Bremsflüssigkeitsbehälter













	kw					! #		
VW - GOLF PLUS Van (521) 01/09→08/14								
 Hauptbremszylinder								
2.0 TDi	103	11/09→08/14		1K-C-500001→; für Rechtslenker; +PR 1ZF / 1AC	24.4152-0132.3	011025	ATE Ø 22,2 ohne Bremsflüssigkeitsbehälter	
				1K-6-565001→; für Rechtslenker; → 1K-8-500000; +PR 1AC / 1AT / 1AS	24.4152-0132.3	011025	ATE Ø 22,2 ohne Bremsflüssigkeitsbehälter	
				1K-9-900001→; für Rechtslenker; → 1K-C-500000; +PR 1ZF	24.4152-0132.3	011025	ATE Ø 22,2 ohne Bremsflüssigkeitsbehälter	
				1K-8-500001→; für Rechtslenker; → 1K-9-899999; +PR 1LK / 1ZA / 1ZC / 1ZD / 1ZE / 1ZF / 1ZM / 1ZP	24.4152-0132.3	011025	ATE Ø 22,2 ohne Bremsflüssigkeitsbehälter	
				1K-9-900001→; für Rechtslenker; → 1K-C-500000; +PR 1ZE / 1LJ / 1ZA	24.4153-0202.3	011027	ATE Ø 23,8 ohne Bremsflüssigkeitsbehälter	
				1K-8-500001→; für Rechtslenker; → 1K-9-899999; +PR 1LJ	24.4153-0202.3	011027	ATE Ø 23,8 ohne Bremsflüssigkeitsbehälter	
				1K-C-500001→; für Rechtslenker; +PR 1ZA / 1ZE / 1AS / 1AT	24.4153-0202.3	011027	ATE Ø 23,8 ohne Bremsflüssigkeitsbehälter	
Drucksensor, Bremskraftverstärker								
1.4 TSi	90 - 118	01/09→08/14		1K-6-565001→; für Rechtslenker; → 1K-9-899999; +PR 1AS	03.0655-0101.2	370008	ATE	
2.0 TDi	103	11/09→08/14		für Linkslenker; → 1K-9-899999; +PR 1AS	03.0655-0101.2	370008	ATE	
VW - GOLF SPORTSVAN VII (AM1, AN1) 02/14→08/20								
 Hauptbremszylinder								
1.0 TSI	63 - 85	05/15→08/20		für Linkslenker	24.4123-1719.3	011017	TRW Ø 23,8 ohne Bremsflüssigkeitsbehälter	
1.2 TSI	63 - 81	04/14→11/17			24.4153-1522.3	011048	ATE Ø 23,8 ohne Bremsflüssigkeitsbehälter	
1.4 TSI	92	04/14→08/20						
1.4 TSI MultiFuel	92	04/14→11/17						
1.5 TSI	96 - 110	05/17→08/20						
1.6	81	05/14→11/16						
1.6 TDI	66 - 85	02/14→08/20						
2.0 TDI	81	05/14→11/17						
1.4 TSI	110	02/14→07/18		05/14→; für Linkslenker	24.4123-1719.3	011017	TRW Ø 23,8 ohne Bremsflüssigkeitsbehälter	
1.6 TDI	81	02/14→11/16						
2.0 TDI	110	02/14→08/20		für Linkslenker	24.4153-1522.3	011048	ATE Ø 23,8 ohne Bremsflüssigkeitsbehälter	
VW - GOLF VAN IV Variant (1J5) 05/99→06/06								
 Bremskraftverstärker								
1.4	55	05/00→06/06		09/00→ 10/01; für Linkslenker; +PR 1AT	03.7860-0602.4	300141	ATE Ø 10" pneumatisch	
1.6	77	05/00→06/06		→ 08/00; für Linkslenker; +PR 1AT	03.7863-0402.4	300124	ATE Ø 10" pneumatisch	
1.9 SDI	50	05/99→05/06						
1.9 TDI	81	05/99→05/06		11/01→ 10/03; für Linkslenker; +PR 1AT	03.7863-3502.4	300128	ATE Ø 10" pneumatisch	
1.9 TDI	66	05/99→05/06		09/00→ 10/01; für Linkslenker; +PR 1AT	03.7860-0602.4	300141	ATE Ø 10" pneumatisch	
				→ 08/00; für Linkslenker; +PR 1AT	03.7863-0402.4	300124	ATE Ø 10" pneumatisch	
				11/01→; für Linkslenker; +PR 1AT	03.7863-3502.4	300128	ATE Ø 10" pneumatisch	
1.9 TDI	74	02/00→06/06		→ 10/01; für Linkslenker; +PR 1AT	03.7860-0602.4	300141	ATE Ø 10" pneumatisch	
				11/01→; für Linkslenker; +PR 1AT	03.7863-3502.4	300128	ATE Ø 10" pneumatisch	
1.9 TDI	85	05/99→04/02		09/00→; für Linkslenker; +PR 1AT	03.7860-0602.4	300141	ATE Ø 10" pneumatisch	
				→ 08/00; für Linkslenker; +PR 1AT	03.7863-0402.4	300124	ATE Ø 10" pneumatisch	
1.9 TDI	96	04/01→05/06		→ 10/01; für Linkslenker; +PR 1AT	03.7860-0602.4	300141	ATE Ø 10" pneumatisch	
				11/01→ 10/03; für Linkslenker; +PR 1AT	03.7863-3502.4	300128	ATE Ø 10" pneumatisch	
 Hauptbremszylinder								
1.4	55	05/00→06/06		→ 08/00; für Linkslenker; +PR 1AT	03.2123-2024.3	010597	ATE Ø 23,8	
1.6	77	05/00→06/06						
1.9 SDI	50	05/99→05/06		09/00→ 10/03; für Linkslenker; +PR 1AT	03.2123-2715.3	010802	ATE Ø 23,8	
1.9 TDI	81	05/99→05/06		09/00→ 10/03; für Rechtslenker; +PR 1AT	03.2123-2774.3	010803	ATE Ø 23,8	
				→ 10/03; für Linkslenker; +PR 1AM / 1AC / 1AH / 1AJ	24.2123-1709.3	010503	Ø 23,8	
1.9 TDI	66 - 85	05/99→05/06		→ 08/00; für Linkslenker; +PR 1AT	03.2123-2024.3	010597	ATE Ø 23,8	
				09/00→; für Linkslenker; +PR 1AT	03.2123-2715.3	010802	ATE Ø 23,8	
				09/00→; für Rechtslenker; +PR 1AT	03.2123-2774.3	010803	ATE Ø 23,8	
				für Linkslenker; +PR 1AM / 1AC / 1AH / 1AJ	24.2123-1709.3	010503	Ø 23,8	
1.9 TDI	74	02/00→06/06		für Linkslenker; +PR 1AT	03.2123-2715.3	010802	ATE Ø 23,8	
→								

	kw					! #		
VW - GOLF VAN IV Variant (1J5) 05/99→06/06								
 Hauptbremszylinder								
1.9 TDI	74	02/00→06/06		für Rechtslenker; +PR 1AT		03.2123-2774.3	010803	ATE Ø 23,8
				für Linkslenker; +PR 1AM / 1AC / 1AH / 1AJ		24.2123-1709.3	010503	Ø 23,8
1.9 TDI	96	04/01→05/06		→ 10/03; für Linkslenker; +PR 1AT		03.2123-2715.3	010802	ATE Ø 23,8
				→ 10/03; für Rechtslenker; +PR 1AT		03.2123-2774.3	010803	ATE Ø 23,8
				→ 10/03; für Linkslenker; +PR 1AM / 1AC / 1AH / 1AJ		24.2123-1709.3	010503	Ø 23,8
VW - GOLF VAN VI Variant (AJ5) 07/09→05/14								
 Bremskraftverstärker								
1.2 TSi	77	09/09→05/14		1K-9-400001→; → 11/10; für Linkslenker; +PR 1ZK		03.7860-8802.4	300291	ATE Ø 10" pneumatisch
1.4 TSi	118	07/09→10/12						
1.6 TDi BlueMotion	77	07/09→05/14		12/09→; für Linkslenker; +PR 1ZD / 1ZP		03.7863-3232.4	300307	ATE Ø 10" pneumatisch
2.0 TDi	103	07/09→05/14		+PR 1AC / 1AT; → 11/09; für Linkslenker		03.7863-3332.4	300308	ATE Ø 10" pneumatisch
1.4 TSi	90	07/09→05/14		12/09→; für Linkslenker; +PR 1ZD / 1ZP		03.7863-3232.4	300307	ATE Ø 10" pneumatisch
				+PR 1AC / 1AT; → 11/09; für Linkslenker		03.7863-3332.4	300308	ATE Ø 10" pneumatisch
1.6 TDi	66	12/09→10/12		1K-9-400001→; → 11/10; für Linkslenker; +PR 1ZK		03.7860-8802.4	300291	ATE Ø 10" pneumatisch
				für Linkslenker; +PR 1ZD / 1ZP		03.7863-3232.4	300307	ATE Ø 10" pneumatisch
				+PR 1AC / 1AT; für Linkslenker		03.7863-3332.4	300308	ATE Ø 10" pneumatisch
 Hauptbremszylinder								
1.2 TSi	77	09/09→05/14		12/09→; für Linkslenker; +PR 1ZD / 1ZP		03.2122-2129.3	010799	ATE Ø 22,2
1.4 TSi	90 - 118	07/09→05/14		→ 11/09; für Linkslenker; +PR 1AC / 1AT		03.2122-2129.3	010799	ATE Ø 22,2
1.6 TDi BlueMotion	77	07/09→05/14		→ 11/09; +PR 1LJ / 1LL		03.2123-3449.3	010808	ATE Ø 23,8
2.0 TDi	103	07/09→05/14		→ 11/09; für Rechtslenker		24.4152-0132.3	011025	ATE Ø 22,2 ohne Bremsflüssigkeitsbehälter
				12/09→; +PR 1ZD / 1ZP; für Rechtslenker		24.4152-0132.3	011025	ATE Ø 22,2 ohne Bremsflüssigkeitsbehälter
				→ 11/09; +PR 1LJ / 1LL; für Rechtslenker		24.4153-0202.3	011027	ATE Ø 23,8 ohne Bremsflüssigkeitsbehälter
				12/09→; +PR 1LJ / 1ZA / 1ZE; für Rechtslenker		24.4153-0202.3	011027	ATE Ø 23,8 ohne Bremsflüssigkeitsbehälter
1.6 TDi	66	12/09→10/12		für Linkslenker; +PR 1ZD / 1ZP / 1AC / 1AT		03.2122-2129.3	010799	ATE Ø 22,2
				+PR 1ZD / 1ZP; für Rechtslenker		24.4152-0132.3	011025	ATE Ø 22,2 ohne Bremsflüssigkeitsbehälter
				+PR 1LJ / 1ZA / 1ZE; für Rechtslenker		24.4153-0202.3	011027	ATE Ø 23,8 ohne Bremsflüssigkeitsbehälter
VW - GOLF VAN VII Variant (BA5) 04/13→03/17								
 Hauptbremszylinder								
1.2 TSi BlueMotion	63 - 77	04/13→03/17		für Linkslenker; +PR 1ZA / 1ZD / 1ZE / 1ZF / 1ZP		03.4153-5403.3	010994	ATE Ø 23,8
1.4 TSi BlueMotion	90 - 103	05/13→03/17				24.4123-1719.3	011017	TRW Ø 23,8 ohne Bremsflüssigkeitsbehälter
1.6 TDi BlueMotion	66 - 81	05/13→03/17						
1.6 TDi BlueMotion 4motion	77	05/13→03/17						
2.0 TDi BlueMotion	110	04/13→03/17						
2.0 TDi BlueMotion 4motion	110	04/13→03/17						
VW - JETTA III (1K2) 09/04→12/13								
 Hauptbremszylinder								
1.4 TSi	90 - 125	07/06→10/10		für Linkslenker; +PR 1AS		03.2122-2129.3	010799	ATE Ø 22,2
1.6	75	09/04→10/10		für Rechtslenker		24.2122-1981.3	011024	ATE Ø 22,2 ohne Bremsflüssigkeitsbehälter
1.6 FSI	85	09/05→10/10						
1.6 MultiFuel	75	01/08→10/10						
1.6 TDI	66 - 77	06/09→10/10						
1.9 TDI	74 - 77	08/05→10/10						
2.0 FSI	110	08/05→10/10						
2.0 TDI	100 - 125	09/05→10/10						
2.0 TDI 16V	103	08/05→10/10						
2.0 TFSI	147	10/05→10/10						
2.5	125	07/08→10/10						
→								

	kw					! #		
VW - JETTA III (1K2) 09/04→12/13								
 Hauptbremszylinder								
2.5	110	01/06→10/10		07/08→; für Linkslenker; +PR 1AS		03.2122-2129.3	010799	ATE Ø 22,2
				07/08→; für Rechtslenker		24.2122-1981.3	011024	ATE Ø 22,2 ohne Bremsflüssigkeitsbehälter
Drucksensor, Bremskraftverstärker								
1.4 TSI	90 - 125	07/06→10/10		für Linkslenker; +PR 1AS		03.0655-0101.2	370008	ATE
1.6 FSI	75	09/04→10/10						
1.6 FSI	85	09/05→10/10						
1.6 MultiFuel	75	01/08→10/10						
1.6 TDI	66 - 77	06/09→10/10						
1.9 TDI	74 - 77	08/05→10/10						
2.0 FSI	110	08/05→10/10						
2.0 TDI	100 - 125	09/05→10/10						
2.0 TDI 16V	103	08/05→10/10						
2.0 TFSI	147	10/05→10/10						
2.5	125	07/08→10/10						
2.5	110	01/06→10/10		07/08→; für Linkslenker; +PR 1AS		03.0655-0101.2	370008	ATE
VW - JETTA IV (162, 163, AV3, AV2) 01/08→12/19								
 Bremskraftverstärker								
2.0 TFSI	147	12/10→07/14		04/11→; für Linkslenker; - ESP		03.7863-3332.4	300308	ATE Ø 10" pneumatisch
2.5	125	04/10→12/17						
2.0 TSI	155	12/12→12/17		für Linkslenker; - ESP		03.7863-3332.4	300308	ATE Ø 10" pneumatisch
 Hauptbremszylinder								
1.2 TSI	77	10/10→12/17		04/11→; für Rechtslenker; +PR 1AT / 1AS		24.4152-0132.3	011025	ATE Ø 22,2 ohne Bremsflüssigkeitsbehälter
1.6 TDI	77	04/10→07/15						
2.0 TDI	103	02/11→12/17						
2.0 TFSI	147	12/10→07/14		04/11→; für Rechtslenker; +PR 1AC		24.4153-0202.3	011027	ATE Ø 23,8 ohne Bremsflüssigkeitsbehälter
2.5	125	04/10→12/17						
1.2 TSI 16V	77	08/14→12/17		für Rechtslenker; +PR 1AT / 1AS		24.4152-0132.3	011025	ATE Ø 22,2 ohne Bremsflüssigkeitsbehälter
1.4 TSI	90 - 118	04/11→12/17						
1.4 TSI Hybrid	125	04/11→12/17		für Rechtslenker; +PR 1AC		24.4153-0202.3	011027	ATE Ø 23,8 ohne Bremsflüssigkeitsbehälter
1.6	63 - 81	12/11→04/18						
1.6 MPi	66	09/15→04/18						
1.8 TSI	125	07/14→12/17						
2.0	85	06/10→12/17						
2.0 TDI	81 - 110	10/10→12/17						
2.0 TSI	155	12/12→12/17						
VW - JETTA VII Stufenheck (BU3, BU4) 12/17→								
 Hauptbremszylinder								
1.4 TSI	110	12/17→		für Rechtslenker; +PR 1AT / 1AS		24.4152-0132.3	011025	ATE Ø 22,2 ohne Bremsflüssigkeitsbehälter
				für Rechtslenker; +PR 1AC		24.4153-0202.3	011027	ATE Ø 23,8 ohne Bremsflüssigkeitsbehälter
VW - LOAD UP (121, 122, BL1, BL2) 12/14→08/20								
 Hauptbremszylinder								
1.0	44	12/14→11/19		für Linkslenker		24.4120-1703.3	011015	TRW Ø 20,6 ohne Bremsflüssigkeitsbehälter
1.0 BlueMotion	55	05/16→11/19						
1.0 EcoFuel	50	12/14→08/20						
1.0 TSi BlueMotion	66	05/16→09/18						
VW - LT 28-35 II Bus (2DB, 2DE, 2DK) 04/96→07/06								
 Hauptbremszylinder								
2.3	105	05/96→07/06		→ 2D-X-012290; + ABS		24.2123-1711.3	010518	Ø 23,8
2.5 SDI	55	07/96→07/06		→ 2D-2-011024; + ABS		24.2123-1711.3	010518	Ø 23,8
2.5 TDI	75	05/96→08/99		→ 2D-2-011024; - ABS		24.2123-1728.3	010558	Ø 23,8
				2D-2-011025→		24.2123-1755.3	010750	Ø 23,8
				2D-X-012291→ 2D-2-011024; + ABS		24.2125-1727.3	010723	Ø 25,4
				2D-2-011025→; + ABS		24.2125-1735.3	010879	TRW Ø 25,4
2.5 TDI	61 - 80	05/99→07/06		→ 2D-2-011024; + ABS		24.2123-1711.3	010518	Ø 23,8
2.8 TDI	96 - 116	01/99→06/06		→ 2D-2-011024; - ABS		24.2123-1728.3	010558	Ø 23,8
				2D-2-011025→		24.2123-1755.3	010750	Ø 23,8

	kw					! #		
VW - LT 28-46 II Kasten (2DA, 2DD, 2DH) 04/96→07/06								
 Hauptbremszylinder								
2.3	105	05/96→07/06		→ 2D-X-012290; + ABS		24.2123-1711.3	010518	Ø 23,8
2.5 SDI	55	09/96→07/06		→ 2D-2-011024; + ABS		24.2123-1711.3	010518	Ø 23,8
2.5 TDI	61 - 80	05/96→07/06		→ 2D-2-011024; - ABS		24.2123-1728.3	010558	Ø 23,8
2.8 TDI	92 - 116	07/97→07/06		2D-2-011025→		24.2123-1755.3	010750	Ø 23,8
				2D-X-012291→ 2D-2-011024; + ABS		24.2125-1727.3	010723	Ø 25,4
				2D-2-011025→; + ABS		24.2125-1735.3	010879	TRW Ø 25,4
VW - LT 28-46 II Pritsche/Fahrgestell (2DC, 2DF, 2DG, 2DL, 2DM) 04/96→07/06								
 Hauptbremszylinder								
2.3	105	06/96→07/06		→ 2D-2-011024; + ABS		24.2123-1711.3	010518	Ø 23,8
2.5 SDI	55	09/96→07/06		→ 2D-X-012290; + ABS		24.2123-1711.3	010518	Ø 23,8
2.5 TDI	61 - 80	06/96→07/06		→ 2D-2-011024; - ABS		24.2123-1728.3	010558	Ø 23,8
2.8 TDI	92 - 116	07/97→07/06		2D-2-011025→		24.2123-1755.3	010750	Ø 23,8
				2D-X-012291→ 2D-2-011024; + ABS		24.2125-1727.3	010723	Ø 25,4
				2D-2-011025→; + ABS		24.2125-1735.3	010879	TRW Ø 25,4
VW - LUPO I (6X1, 6E1) 09/98→07/05								
 Bremskraftverstärker								
1.4 16V	74	08/99→07/05		für Linkslenker; + ESP; +PR 1AT / 1LX / 1ZE		03.7853-0102.4	300252	ATE Ø 9" pneumatisch
1.4 FSI	77	02/01→07/05						
1.6 GTI	92	09/00→07/05						
 Hauptbremszylinder								
1.0	37	09/98→07/05		- ABS		03.2120-3943.3	010532	ATE Ø 20,6
1.2 TDI 3L	45	07/99→07/05		für Linkslenker; + ABS / - ESP		03.2122-1344.3	010593	ATE Ø 22,2
1.4	44	10/00→07/05						
1.4 TDI	55	01/99→07/05						
1.7 SDI	44	09/98→07/05						
1.4 16V	55	09/98→07/05		10/98→; - ABS		03.2120-3943.3	010532	ATE Ø 20,6
				10/98→; für Linkslenker; + ABS / - ESP		03.2122-1344.3	010593	ATE Ø 22,2
1.4 16V	74	08/99→07/05		für Linkslenker; + ABS / - ESP		03.2123-1824.3	010596	ATE Ø 23,8
1.4 FSI	77	02/01→07/05						
1.6 GTI	92	09/00→07/05						
VW - MULTIVAN T5 (7HM, 7HN, 7HF, 7EF, 7EM, 7EN) 04/03→08/15								
 Bremskraftverstärker								
1.9 TDI	62 - 77	04/03→11/09		+PR 1AJ / 1AE / 1AC / 1AR; → 7H-A-050000		03.7765-1002.4	300246	ATE Ø 10 / 9" pneumatisch
2.0	85	11/03→08/15		+PR 1AK; → 7H-A-050000		03.7868-3702.4	300208	ATE Ø 10 / 8" pneumatisch
2.0 BiTDI	132	09/09→08/15						
2.0 BiTDI 4motion	132	09/09→08/15						
2.0 TDI	62 - 103	09/09→08/15						
2.0 TDI 4motion	103	09/09→08/15						
2.5 TDI	96 - 128	04/03→11/09						
2.5 TDI 4motion	96 - 128	07/04→11/09						
VR6 3.2	173	02/04→12/09						
VR6 3.2 4motion	173	07/04→12/09						
Pedalwegsensor, Bremspedal								
1.9 TDI	62 - 77	04/03→11/09		+PR 1AT; → 7H-A-050000		03.0655-0006.2	370006	ATE
2.0	85	11/03→08/15						
2.0 BiTDI	132	09/09→08/15						
2.0 BiTDI 4motion	132	09/09→08/15						
2.0 TDI	62 - 103	09/09→08/15						
2.0 TDI 4motion	103	09/09→08/15						
2.5 TDI	96 - 128	04/03→11/09						
2.5 TDI 4motion	96 - 128	07/04→11/09						
VR6 3.2	173	02/04→12/09						
VR6 3.2 4motion	173	07/04→12/09						
 Hauptbremszylinder								
1.9 TDI	62 - 77	04/03→11/09		→ 7H-A-050000		03.2126-3014.3	010811	ATE Ø 27
2.0	85	11/03→08/15		7H-6-000001→ 7H-6-200000; für Rechtslenker; +PR 1AT		03.2126-3014.3	010811	ATE Ø 27
VR6 3.2	173	02/04→12/09		7H-A-200001→		03.2126-3144.3	010941	ATE Ø 27
→								

	kw			 	! #		
VW - MULTIVAN T5 (7HM, 7HN, 7HF, 7EF, 7EM, 7EN) 04/03→08/15							
 Hauptbremszylinder							
2.0 BiTDI	132	09/09→08/15		→ 7H-A-050000		03.2126-3014.3 010811	ATE Ø 27
2.0 BiTDI 4motion	132	09/09→08/15		7H-A-200001→		03.2126-3144.3 010941	ATE Ø 27
2.0 TDI	62 - 103	09/09→08/15					
2.0 TDI 4motion	100 - 103	09/09→08/15					
2.5 TDI	96 - 128	04/03→11/09					
2.5 TDI 4motion	96 - 128	07/04→11/09					
VR6 3.2 4motion	173	07/04→12/09					
2.0 TDI	84	05/11→08/15				03.2126-3144.3 010941	ATE Ø 27
2.0 TSI	110 - 150	05/11→08/15					
2.0 TSI 4motion	150	07/11→08/15					
VW - NEW BEETLE (9C1, 1C1) 01/98→11/10							
 Bremskraftverstärker							
1.4	55	11/01→09/10		→ 9C-2-620000; für Linkslenker; + ESP		03.7860-0602.4 300141	ATE Ø 10" pneumatisch
				9C-2-620001→; für Linkslenker; + ESP; → 05/10		03.7863-3502.4 300128	ATE Ø 10" pneumatisch
1.6	74	10/99→09/00		9C-Y-613783→ 9C-2-620000; für Linkslenker; + ESP		03.7860-0602.4 300141	ATE Ø 10" pneumatisch
				11/99→; → 9C-Y-613782; für Linkslenker; + ESP		03.7863-0402.4 300124	ATE Ø 10" pneumatisch
				9C-2-620001→; für Linkslenker; + ESP		03.7863-3502.4 300128	ATE Ø 10" pneumatisch
1.6	75	06/00→09/10		9C-Y-613783→ 9C-2-620000; für Linkslenker; + ESP		03.7860-0602.4 300141	ATE Ø 10" pneumatisch
1.8 T	110	10/99→09/10					
1.9 TDI	74	02/01→09/10		→ 9C-Y-613782; für Linkslenker; + ESP		03.7863-0402.4 300124	ATE Ø 10" pneumatisch
2.0	85	01/98→09/10					
2.5	110	07/05→09/10		9C-2-620001→; für Linkslenker; + ESP; → 05/10		03.7863-3502.4 300128	ATE Ø 10" pneumatisch
1.8 T	132	11/01→06/05		→ 9C-2-620000; für Linkslenker; + ESP		03.7860-0602.4 300141	ATE Ø 10" pneumatisch
				9C-2-620001→; für Linkslenker; + ESP		03.7863-3502.4 300128	ATE Ø 10" pneumatisch
1.9 TDI	66	01/98→06/04		9C-Y-613783→; → 02/01; für Linkslenker; + ESP		03.7860-0602.4 300141	ATE Ø 10" pneumatisch
				→ 9C-Y-613782; für Linkslenker; + ESP		03.7863-0402.4 300124	ATE Ø 10" pneumatisch
1.9 TDI	77	07/05→09/10		für Linkslenker; + ESP; → 05/10		03.7863-3502.4 300128	ATE Ø 10" pneumatisch
2.3 V5	125	10/00→09/10		9C-Y-613783→ 9C-2-620000; für Linkslenker; + ESP		03.7860-0602.4 300141	ATE Ø 10" pneumatisch
				→ 9C-Y-613782; für Linkslenker; + ESP		03.7863-0402.4 300124	ATE Ø 10" pneumatisch
				9C-2-620001→; für Linkslenker; + ESP; → 05/05		03.7863-3502.4 300128	ATE Ø 10" pneumatisch
3.2 RSI 4motion	165	04/00→05/01		9C-Y-613783→ 9C-2-620000; für Linkslenker; + ESP		03.7860-0602.4 300141	ATE Ø 10" pneumatisch
				→ 9C-Y-613782; für Linkslenker; + ESP		03.7863-0402.4 300124	ATE Ø 10" pneumatisch
				9C-2-620001→; für Linkslenker; + ESP		03.7863-3502.4 300128	ATE Ø 10" pneumatisch
 Hauptbremszylinder							
1.4	55	11/01→09/10		für Linkslenker; + ESP; → 05/10		03.2123-2715.3 010802	ATE Ø 23,8
				9C-7-557429→; für Rechtslenker; + ESP; → 05/10		03.2123-2774.3 010803	ATE Ø 23,8
				für Rechtslenker; + ESP; → 9C-7-557428		03.2123-2774.3 010803	ATE Ø 23,8
				für Linkslenker; - ESP; → 06/05		24.2123-1709.3 010503	Ø 23,8
1.6	74	10/99→09/00		11/99→; → 9C-Y-613782; für Linkslenker; + ESP		03.2123-2024.3 010597	ATE Ø 23,8
				9C-Y-613783→; für Linkslenker; + ESP		03.2123-2715.3 010802	ATE Ø 23,8
				9C-Y-613783→; für Rechtslenker; + ESP; → 9C-7-557428		03.2123-2774.3 010803	ATE Ø 23,8
				9C-7-557429→; für Rechtslenker; + ESP		03.2123-2774.3 010803	ATE Ø 23,8
				11/99→; für Linkslenker; - ESP		24.2123-1709.3 010503	Ø 23,8
1.6	75	06/00→09/10		→ 9C-Y-613782; für Linkslenker; + ESP		03.2123-2024.3 010597	ATE Ø 23,8
1.8 T	110	10/99→09/10					
1.9 TDI	74	02/01→09/10		9C-Y-613783→; für Linkslenker; + ESP; → 05/10		03.2123-2715.3 010802	ATE Ø 23,8
2.0	85	01/98→09/10					
				9C-Y-613783→; für Rechtslenker; + ESP; → 9C-7-557428		03.2123-2774.3 010803	ATE Ø 23,8
				9C-7-557429→; für Rechtslenker; + ESP; → 05/10		03.2123-2774.3 010803	ATE Ø 23,8
				für Linkslenker; - ESP; → 06/05		24.2123-1709.3 010503	Ø 23,8
1.8 T	132	11/01→06/05		für Linkslenker; + ESP		03.2123-2715.3 010802	ATE Ø 23,8
				für Rechtslenker; + ESP		03.2123-2774.3 010803	ATE Ø 23,8
→							



VW - NEW BEETLE (9C1, 1C1) 01/98→11/10

Hauptbremszylinder

1.8 T	132	11/01→06/05		für Linkslenker; - ESP	24.2123-1709.3 010503	Ø 23,8
1.9 TDI	66	01/98→06/04		→ 9C-Y-613782; für Linkslenker; + ESP	03.2123-2024.3 010597	ATE Ø 23,8
				9C-Y-613783→; → 02/01; für Linkslenker; + ESP	03.2123-2715.3 010802	ATE Ø 23,8
				9C-Y-613783→; → 02/01; für Rechtslenker; + ESP	03.2123-2774.3 010803	ATE Ø 23,8
				→ 02/01; für Linkslenker; - ESP	24.2123-1709.3 010503	Ø 23,8
1.9 TDI	77	07/05→09/10		für Linkslenker; + ESP; → 05/10	03.2123-2715.3 010802	ATE Ø 23,8
				9C-7-557429→; für Rechtslenker; + ESP; → 05/10	03.2123-2774.3 010803	ATE Ø 23,8
				für Rechtslenker; + ESP; → 9C-7-557428	03.2123-2774.3 010803	ATE Ø 23,8
2.3 V5	125	10/00→09/10		→ 9C-Y-613782; für Linkslenker; + ESP	03.2123-2024.3 010597	ATE Ø 23,8
				9C-Y-613783→; für Linkslenker; + ESP; → 12/05	03.2123-2715.3 010802	ATE Ø 23,8
				9C-Y-613783→; für Rechtslenker; + ESP; → 12/05	03.2123-2774.3 010803	ATE Ø 23,8
				für Linkslenker; - ESP; → 05/05	24.2123-1709.3 010503	Ø 23,8
2.5	110	07/05→09/10		→ 9C-Y-613782; für Linkslenker; + ESP	03.2123-2024.3 010597	ATE Ø 23,8
				9C-Y-613783→; für Linkslenker; + ESP; → 05/10	03.2123-2715.3 010802	ATE Ø 23,8
				9C-Y-613783→; für Rechtslenker; + ESP; → 9C-7-557428	03.2123-2774.3 010803	ATE Ø 23,8
				9C-7-557429→; für Rechtslenker; + ESP; → 05/10	03.2123-2774.3 010803	ATE Ø 23,8
				für Linkslenker; - ESP	24.2123-1709.3 010503	Ø 23,8
3.2 RSI 4motion	165	04/00→05/01		→ 9C-Y-613782; für Linkslenker; + ESP	03.2123-2024.3 010597	ATE Ø 23,8
				9C-Y-613783→; für Linkslenker; + ESP	03.2123-2715.3 010802	ATE Ø 23,8
				9C-Y-613783→; für Rechtslenker; + ESP	03.2123-2774.3 010803	ATE Ø 23,8
				für Linkslenker; - ESP	24.2123-1709.3 010503	Ø 23,8













VW - NEW BEETLE Cabriolet (1Y7) 09/02→12/11

Bremskraftverstärker

1.4	55	01/03→09/10		+ ESP; für Linkslenker; → 05/10	03.7863-3502.4 300128	ATE Ø 10" pneumatisch
1.6	75	01/03→09/10				
1.9 TDI	77	07/05→09/10				
2.5	110	07/05→09/10				
1.8 T	110	01/03→09/10		12/03→; für Linkslenker; + ESP; → 05/10	03.7863-3502.4 300128	ATE Ø 10" pneumatisch
1.9 TDI	74	06/03→09/10		07/03→; für Linkslenker; + ESP; → 05/10	03.7863-3502.4 300128	ATE Ø 10" pneumatisch
2.0	85	09/02→10/10		01/03→; für Linkslenker; + ESP; → 05/10	03.7863-3502.4 300128	ATE Ø 10" pneumatisch

Hauptbremszylinder

1.4	55	01/03→09/10		→ 05/10; + ESP; für Linkslenker	03.2123-2715.3 010802	ATE Ø 23,8
1.6	75	01/03→09/10		1Y-7-413421→; für Rechtslenker; + ESP; → 05/10	03.2123-2774.3 010803	ATE Ø 23,8
				→ 1Y-7-413420; für Rechtslenker; + ESP	03.2123-2774.3 010803	ATE Ø 23,8
				für Linkslenker; - ESP; → 06/05	24.2123-1709.3 010503	Ø 23,8
1.8 T	110	01/03→09/10		12/03→; für Linkslenker; + ESP; → 05/10	03.2123-2715.3 010802	ATE Ø 23,8
				1Y-7-413421→; für Rechtslenker; + ESP; → 05/10	03.2123-2774.3 010803	ATE Ø 23,8
				12/03→; für Rechtslenker; + ESP; → 1Y-7-413420	03.2123-2774.3 010803	ATE Ø 23,8
				12/03→; für Linkslenker; - ESP; → 06/05	24.2123-1709.3 010503	Ø 23,8
1.9 TDI	74	06/03→09/10		07/03→; für Linkslenker; + ESP; → 05/10	03.2123-2715.3 010802	ATE Ø 23,8
				07/03→; für Rechtslenker; + ESP; → 1Y-7-413420	03.2123-2774.3 010803	ATE Ø 23,8
				1Y-7-413421→; für Rechtslenker; + ESP; → 05/10	03.2123-2774.3 010803	ATE Ø 23,8
				07/03→; für Linkslenker; - ESP; → 06/05	24.2123-1709.3 010503	Ø 23,8
1.9 TDI	77	07/05→09/10		→ 05/10; + ESP; für Linkslenker	03.2123-2715.3 010802	ATE Ø 23,8
2.5	110	07/05→09/10		1Y-7-413421→; für Rechtslenker; + ESP; → 05/10	03.2123-2774.3 010803	ATE Ø 23,8
				→ 1Y-7-413420; für Rechtslenker; + ESP	03.2123-2774.3 010803	ATE Ø 23,8
				01/03→; für Linkslenker; + ESP; → 05/10	03.2123-2715.3 010802	ATE Ø 23,8
2.0	85	09/02→10/10		1Y-7-413421→; für Rechtslenker; + ESP; → 05/10	03.2123-2774.3 010803	ATE Ø 23,8
				01/03→; für Rechtslenker; + ESP; → 1Y-7-413420	03.2123-2774.3 010803	ATE Ø 23,8
				01/03→; für Linkslenker; - ESP; → 06/05	24.2123-1709.3 010503	Ø 23,8

	kw					! #		
VW - PASSAT ALLTRACK B7 (365) 01/12→12/14								
 Bremskraftverstärker								
1.8 TSI	112 - 118	01/12→12/14		+PR 1ZG; für Linkslenker		03.7873-4402.4	300292	ATE Ø 11" pneumatisch
2.0 TDI 2.0 TDI 4motion	103 - 130	01/12→12/14		für Linkslenker; +PR 1LA / 1LB / 1ZM		03.7873-4502.4	300284	ATE Ø 11" pneumatisch
2.0 TSI 4motion	155	01/12→12/14						
 Hauptbremszylinder								
1.8 TSI	112 - 118	01/12→12/14		+PR 1ZG; für Linkslenker		03.4152-0116.3	010814	ATE Ø 22,2
2.0 TDI 2.0 TDI 4motion	103 - 130	01/12→12/14		+PR 1LA / 1LB / 1ZM; für Linkslenker		03.4153-0186.3	010816	ATE Ø 23,8
2.0 TSI 4motion	155	01/12→12/14		+PR 1LA / 1LB / 1ZM; für Rechtslenker		24.4153-0192.3	011026	ATE Ø 23,8 ohne Bremsflüssigkeitsbehälter
VW - PASSAT ALLTRACK B8 Variant (3G5, CB5) 05/15→								
 Hauptbremszylinder								
1.4 TSI 4motion 2.0 TDI 4motion	110 - 176	05/15→		für Linkslenker; +PR 1ZA / 1ZD		24.4123-1719.3	011017	TRW Ø 23,8 ohne Bremsflüssigkeitsbehälter
2.0 TSI 4motion	162 - 206	07/15→				24.4153-1522.3	011048	ATE Ø 23,8 ohne Bremsflüssigkeitsbehälter
VW - PASSAT B5.5 (3B3) 10/00→12/05								
 Hauptbremszylinder								
1.6 1.8 T 1.8 T 20V 2.3 V5 2.3 V5 4motion 2.5 TDI 2.5 TDI 4motion 2.8 4motion	75 - 142	11/00→05/05		05/02→		03.2125-0373.3	010810	ATE Ø 25,4
				→ 3B-X-800000; - ESP		24.2123-1717.3	010521	Ø 23,8
				→ 3B-X-800000; + ESP		24.2123-1730.3	010620	Ø 23,8
				3B-Y-000001→ 3B-1-400000; für Linkslenker; - ESP		24.2125-1712.3	010622	Ø 25,4
				3B-Y-000001→ 3B-1-400000; für Linkslenker; + ESP		24.2125-1713.3	010623	Ø 25,4
				3B-2-000001→		24.2125-1720.3	010688	TRW Ø 25,4
1.8 T 4motion	125	11/03→05/05		→ 3B-X-800000; - ESP		24.2123-1717.3	010521	Ø 23,8
				→ 3B-X-800000; + ESP		24.2123-1730.3	010620	Ø 23,8
1.9 TDI 1.9 TDI 4motion 2.0 2.0 4motion	74 - 85	11/00→05/05		05/02→		03.2125-0373.3	010810	ATE Ø 25,4
				→ 3B-1-400000; für Linkslenker; - ESP		24.2125-1712.3	010622	Ø 25,4
				→ 3B-1-400000; für Linkslenker; + ESP		24.2125-1713.3	010623	Ø 25,4
				3B-2-000001→		24.2125-1720.3	010688	TRW Ø 25,4
2.0	96	11/01→05/05		05/02→		03.2125-0373.3	010810	ATE Ø 25,4
						24.2125-1720.3	010688	TRW Ø 25,4
2.0 TDI	100	12/03→05/05				03.2125-0373.3	010810	ATE Ø 25,4
						24.2125-1720.3	010688	TRW Ø 25,4
2.5 TDI 2.5 TDI 4motion 2.8	120 - 142	05/03→05/05				03.2125-0373.3	010810	ATE Ø 25,4
				→ 3B-X-800000; - ESP		24.2123-1717.3	010521	Ø 23,8
				→ 3B-X-800000; + ESP		24.2123-1730.3	010620	Ø 23,8
				3B-Y-000001→ 3B-1-400000; für Linkslenker; - ESP		24.2125-1712.3	010622	Ø 25,4
				3B-Y-000001→ 3B-1-400000; für Linkslenker; + ESP		24.2125-1713.3	010623	Ø 25,4
				3B-2-000001→		24.2125-1720.3	010688	TRW Ø 25,4
4.0 W8 4motion	202	09/01→09/04		05/02→		03.2125-0373.3	010810	ATE Ø 25,4
						24.2125-1720.3	010688	TRW Ø 25,4
VW - PASSAT B5.5 Variant (3B6) 09/00→08/05								
 Hauptbremszylinder								
1.6 1.8 T 20V 2.3 VR5 2.3 VR5 4motion 2.5 TDI 2.5 TDI 4motion 2.8 4motion	75 - 142	11/00→05/05		05/02→		03.2125-0373.3	010810	ATE Ø 25,4
				→ 3B-X-800000; - ESP		24.2123-1717.3	010521	Ø 23,8
				→ 3B-X-800000; + ESP		24.2123-1730.3	010620	Ø 23,8
				3B-Y-000001→ 3B-1-400000; für Linkslenker; - ESP		24.2125-1712.3	010622	Ø 25,4
				3B-Y-000001→ 3B-1-400000; für Linkslenker; + ESP		24.2125-1713.3	010623	Ø 25,4
				3B-2-000001→		24.2125-1720.3	010688	TRW Ø 25,4
1.8 4motion	125	11/03→05/05				03.2125-0373.3	010810	ATE Ø 25,4
				→ 3B-1-400000; für Linkslenker; - ESP		24.2125-1712.3	010622	Ø 25,4
				→ 3B-1-400000; für Linkslenker; + ESP		24.2125-1713.3	010623	Ø 25,4
→								

VW - PASSAT B5.5 Variant (3B6) 09/00→08/05











Hauptbremszylinder

1.8 4motion	125	11/03→05/05		3B-2-000001→	24.2125-1720.3 010688	TRW Ø 25,4
1.8 T	125	05/02→08/05		→ 06/05	03.2125-0373.3 010810	ATE Ø 25,4
				→ 3B-X-800000; - ESP	24.2123-1717.3 010521	Ø 23,8
				→ 3B-X-800000; + ESP	24.2123-1730.3 010620	Ø 23,8
				3B-Y-000001→ 3B-1-400000; für Linkslenker; - ESP	24.2125-1712.3 010622	Ø 25,4
				3B-Y-000001→ 3B-1-400000; für Linkslenker; + ESP	24.2125-1713.3 010623	Ø 25,4
			3B-2-000001→; → 06/05	24.2125-1720.3 010688	TRW Ø 25,4	
1.9 TDI	74 - 96	11/00→05/05		05/02→	03.2125-0373.3 010810	ATE Ø 25,4
1.9 TDI 4motion	96	11/00→05/05		→ 3B-1-400000; für Linkslenker; - ESP	24.2125-1712.3 010622	Ø 25,4
2.0	85	11/00→05/05		→ 3B-1-400000; für Linkslenker; + ESP	24.2125-1713.3 010623	Ø 25,4
2.0 4motion	85	11/00→05/05		3B-2-000001→	24.2125-1720.3 010688	TRW Ø 25,4
2.0	96	11/01→05/05		05/02→	03.2125-0373.3 010810	ATE Ø 25,4
					24.2125-1720.3 010688	TRW Ø 25,4
2.0 TDI	100	12/03→05/05			03.2125-0373.3 010810	ATE Ø 25,4
					24.2125-1720.3 010688	TRW Ø 25,4
2.5 TDI	120	05/03→05/05			03.2125-0373.3 010810	ATE Ø 25,4
2.5 TDI 4motion	132	01/03→05/05		→ 3B-X-800000; - ESP	24.2123-1717.3 010521	Ø 23,8
				→ 3B-X-800000; + ESP	24.2123-1730.3 010620	Ø 23,8
				3B-Y-000001→ 3B-1-400000; für Linkslenker; - ESP	24.2125-1712.3 010622	Ø 25,4
				3B-Y-000001→ 3B-1-400000; für Linkslenker; + ESP	24.2125-1713.3 010623	Ø 25,4
				3B-2-000001→	24.2125-1720.3 010688	TRW Ø 25,4
2.8	142	10/00→08/05		05/02→ 06/05	03.2125-0373.3 010810	ATE Ø 25,4
				→ 3B-X-800000; - ESP	24.2123-1717.3 010521	Ø 23,8
				→ 3B-X-800000; + ESP	24.2123-1730.3 010620	Ø 23,8
				3B-Y-000001→ 3B-1-400000; für Linkslenker; - ESP	24.2125-1712.3 010622	Ø 25,4
				3B-Y-000001→ 3B-1-400000; für Linkslenker; + ESP	24.2125-1713.3 010623	Ø 25,4
			3B-2-000001→; → 06/05	24.2125-1720.3 010688	TRW Ø 25,4	
4.0 W8 4motion	202	09/01→09/04		05/02→	03.2125-0373.3 010810	ATE Ø 25,4
					24.2125-1720.3 010688	TRW Ø 25,4











VW - PASSAT B5 (3B2) 08/96→12/01













Hauptbremszylinder











1.6	74	10/96→11/00		→ 3B-X-800000; - ESP	24.2123-1717.3 010521	Ø 23,8
1.8 T	110	10/96→11/00		→ 3B-X-800000; + ESP	24.2123-1730.3 010620	Ø 23,8
1.9 TDI	81 - 85	10/96→11/00		3B-Y-000001→ 3B-1-400000; für Linkslenker; - ESP	24.2125-1712.3 010622	Ø 25,4
				3B-Y-000001→ 3B-1-400000; für Linkslenker; + ESP	24.2125-1713.3 010623	Ø 25,4
1.9 TDI 4motion	85	08/99→11/00				
1.9 TDI Syncro/4motion	81	06/97→08/00		3B-Y-000001→ 3B-1-400000; für Linkslenker; + ESP	24.2125-1713.3 010623	Ø 25,4
2.3 VR5	110	10/96→11/00				
2.3 VR5 Syncro/4motion	110	10/97→11/00		3B-2-000001→	24.2125-1720.3 010688	TRW Ø 25,4
2.5 TDI Syncro/4motion	110	12/98→11/00				
2.8 V6	132 - 142	08/96→11/00				
2.8 V6 4motion	140	09/99→11/00				
2.8 V6 Syncro/4motion	142	10/96→11/00				
1.8	85 - 92	10/96→11/00		→ 3B-X-800000; - ESP	24.2123-1717.3 010521	Ø 23,8
				→ 3B-X-800000; + ESP	24.2123-1730.3 010620	Ø 23,8
				3B-Y-000001→; → 09/00; für Linkslenker; - ESP	24.2125-1712.3 010622	Ø 25,4
				3B-Y-000001→; → 09/00; für Linkslenker; + ESP	24.2125-1713.3 010623	Ø 25,4
1.8 Syncro/4motion	92	12/96→08/00		→ 3B-X-800000; - ESP	24.2123-1717.3 010521	Ø 23,8
				→ 3B-X-800000; + ESP	24.2123-1730.3 010620	Ø 23,8
				3B-Y-000001→; für Linkslenker; - ESP	24.2125-1712.3 010622	Ø 25,4
				3B-Y-000001→; für Linkslenker; + ESP	24.2125-1713.3 010623	Ø 25,4
1.9 TDI	74	02/00→11/00		10/00→; → 3B-1-400000; für Linkslenker; - ESP	24.2125-1712.3 010622	Ø 25,4
2.0	88	04/00→11/00		10/00→; → 3B-1-400000; für Linkslenker; + ESP	24.2125-1713.3 010623	Ø 25,4
2.0 4motion	88	04/00→11/00				
				3B-2-000001→	24.2125-1720.3 010688	TRW Ø 25,4
2.5 TDI	110	07/98→11/00		08/98→; → 3B-X-800000; - ESP	24.2123-1717.3 010521	Ø 23,8
				08/98→; → 3B-X-800000; + ESP	24.2123-1730.3 010620	Ø 23,8











	kw			 	! #		
VW - PASSAT B5 (3B2) 08/96→12/01							
 Hauptbremszylinder							
2.5 TDI	110	07/98→11/00		3B-Y-000001→ 3B-1-400000; für Linkslenker; - ESP		24.2125-1712.3 010622	Ø 25,4
				3B-Y-000001→ 3B-1-400000; für Linkslenker; + ESP		24.2125-1713.3 010623	Ø 25,4
				3B-2-000001→		24.2125-1720.3 010688	TRW Ø 25,4
VW - PASSAT B5 Variant (3B5) 05/97→12/01							
 Hauptbremszylinder							
1.6	74	06/97→11/00		→ 3B-X-800000; - ESP		24.2123-1717.3 010521	Ø 23,8
1.8 T	110	05/97→11/00		→ 3B-X-800000; + ESP		24.2123-1730.3 010620	Ø 23,8
1.9 TDI	81 - 85	06/97→11/00		3B-Y-000001→ 3B-1-400000; für Linkslenker; - ESP		24.2125-1712.3 010622	Ø 25,4
1.9 TDI 4motion	85	08/99→11/00		3B-Y-000001→ 3B-1-400000; für Linkslenker; + ESP		24.2125-1713.3 010623	Ø 25,4
1.9 TDI Syncro/4motion	81	06/97→08/00		3B-2-000001→		24.2125-1720.3 010688	TRW Ø 25,4
2.3 VR5	110	06/97→11/00					
2.3 VR5 Syncro/4motion	110	10/97→11/00					
2.5 TDI Syncro/4motion	110	12/98→11/00					
2.8 V6	132 - 142	06/97→11/00					
2.8 V6 4motion	140	09/99→11/00					
2.8 V6 Syncro/4motion	142	06/97→11/00					
1.8	85 - 92	06/97→11/00		→ 3B-X-800000; - ESP		24.2123-1717.3 010521	Ø 23,8
				→ 3B-X-800000; + ESP		24.2123-1730.3 010620	Ø 23,8
1.8 Syncro/4motion	92	06/97→11/00		3B-Y-000001→; → 09/00; für Linkslenker; - ESP		24.2125-1712.3 010622	Ø 25,4
1.9 TDI	66	06/97→11/00		3B-Y-000001→; → 09/00; für Linkslenker; + ESP		24.2125-1713.3 010623	Ø 25,4
1.9 TDI	74	02/00→11/00		10/00→; → 3B-1-400000; für Linkslenker; - ESP		24.2125-1712.3 010622	Ø 25,4
2.0	88	04/00→11/00		10/00→; → 3B-1-400000; für Linkslenker; + ESP		24.2125-1713.3 010623	Ø 25,4
2.0 4motion	88	04/00→11/00		3B-2-000001→		24.2125-1720.3 010688	TRW Ø 25,4
2.5 TDI	110	07/98→11/00		08/98→; → 3B-X-800000; - ESP		24.2123-1717.3 010521	Ø 23,8
				08/98→; → 3B-X-800000; + ESP		24.2123-1730.3 010620	Ø 23,8
				3B-Y-000001→ 3B-1-400000; für Linkslenker; - ESP		24.2125-1712.3 010622	Ø 25,4
				3B-Y-000001→ 3B-1-400000; für Linkslenker; + ESP		24.2125-1713.3 010623	Ø 25,4
				3B-2-000001→		24.2125-1720.3 010688	TRW Ø 25,4
VW - PASSAT B6 (3C2) 03/05→12/10							
 Bremskraftverstärker							
1.4 TSI	90	05/07→07/10		10/07→; für Linkslenker; - ESP		03.7873-4402.4 300292	ATE Ø 11" pneumatisch
1.8 TSI	118	05/07→07/10					
1.4 TSI EcoFuel	110	01/09→07/10		für Linkslenker; - ESP		03.7873-4402.4 300292	ATE Ø 11" pneumatisch
1.6	75	05/05→07/10					
1.6 FSI	85	03/05→06/08					
1.6 TDI	77	08/09→07/10					
1.8 TSI	112	11/09→07/10					
1.9 TDI	77	03/05→07/10					
2.0 BlueTDI	105	01/09→11/10					
2.0 FSI	110 - 125	03/05→07/10					
2.0 FSI 4motion	110	09/05→07/10					
2.0 TDI	81 - 125	03/05→11/10					
2.0 TDI 16V	103	03/05→07/10					
2.0 TDI 16V 4motion	103	03/05→08/10					
2.0 TDI 4motion	103 - 125	03/05→07/10					
2.0 TFSI	147	07/05→07/10					
3.2 FSI 4motion	184	11/05→07/10					
3.6 R36 4motion	220	04/07→07/10		für Linkslenker		03.7873-4502.4 300284	ATE Ø 11" pneumatisch
 Hauptbremszylinder							
1.4 TSI	90	05/07→07/10		10/07→; +PR 1ZG; für Linkslenker		03.4152-0116.3 010814	ATE Ø 22,2
1.8 TSI	118	05/07→07/10		10/07→; für Linkslenker; +PR 1LJ / 1LK / 1LH / 1LM		03.4153-0186.3 010816	ATE Ø 23,8
				10/07→; für Rechtslenker; +PR 1LJ / 1LK / 1LH / 1LM		24.4153-0192.3 011026	ATE Ø 23,8 ohne Bremsflüssigkeitsbehälter
1.4 TSI EcoFuel	110	01/09→07/10		für Linkslenker; +PR 1ZG		03.4152-0116.3 010814	ATE Ø 22,2
1.6	75	05/05→07/10		für Linkslenker; +PR 1LJ / 1LK / 1LH / 1LM		03.4153-0186.3 010816	ATE Ø 23,8
1.6 FSI	85	03/05→06/08					
1.6 TDI	77	08/09→07/10					
1.8 TSI	112	11/09→07/10					
→							













	kw			 	! #		
VW - PASSAT B6 (3C2) 03/05→12/10							
 Hauptbremszylinder							
1.9 TDI	77	03/05→07/10		für Rechtslenker; +PR 1LJ / 1LK / 1LH / 1LM	24.4153-0192.3	011026	ATE Ø 23,8 ohne Bremsflüssigkeitsbehälter
2.0 BlueTDI	105	01/09→11/10					
2.0 FSI	110	03/05→07/10					
	125						
2.0 FSI 4motion	110	09/05→07/10					
2.0 TDI	81	03/05→11/10					
	125						
2.0 TDI 16V	103	03/05→07/10					
2.0 TDI 16V 4motion	103	03/05→08/10					
2.0 TDI 4motion	103	03/05→07/10					
	125						
2.0 TFSI	147	07/05→07/10					
3.2 FSI 4motion	184	11/05→07/10					
3.6 R36 4motion	220	04/07→07/10					
VW - PASSAT B6 Variant (3C5) 08/05→11/11							
 Bremskraftverstärker							
1.4 TSI	90	05/07→11/10		10/07→; +PR 1LJ; für Linkslenker	03.7873-4502.4	300284	ATE Ø 11" pneumatisch
1.4 TSI EcoFuel	110	01/09→11/10		+PR 1LJ; für Linkslenker	03.7873-4502.4	300284	ATE Ø 11" pneumatisch
1.6	75	08/05→11/10		+PR 1ZG; für Linkslenker	03.7873-4402.4	300292	ATE Ø 11" pneumatisch
1.6 FSI	85	08/05→06/08					
1.6 TDI	77	08/09→11/10		+PR 1LJ; für Linkslenker	03.7873-4502.4	300284	ATE Ø 11" pneumatisch
1.8 TSI	112	11/09→11/10					
1.9 TDI	77	08/05→11/10					
2.0 BlueTDI	105	01/09→11/10					
2.0 FSI	110	08/05→11/10					
2.0 FSI 4motion	110	09/05→11/10					
2.0 TDI	81	08/05→11/10					
	125						
2.0 TDI 16V	103	08/05→11/10					
2.0 TDI 4motion	125	05/09→11/10					
2.0 TFSI	147	08/05→11/10					
3.2 FSI 4motion	184	11/05→11/10					
1.8 TSI	118	05/07→10/11		10/07→; +PR 1ZG; für Linkslenker	03.7873-4402.4	300292	ATE Ø 11" pneumatisch
				10/07→; +PR 1LJ; für Linkslenker	03.7873-4502.4	300284	ATE Ø 11" pneumatisch
2.0 TDI 16V 4motion	103	08/05→11/10		09/05→; +PR 1ZG; für Linkslenker	03.7873-4402.4	300292	ATE Ø 11" pneumatisch
2.0 TDI 4motion	103	08/05→05/09		09/05→; +PR 1LJ; für Linkslenker	03.7873-4502.4	300284	ATE Ø 11" pneumatisch
3.6 R36 4motion	220	04/07→11/10		für Linkslenker	03.7873-4502.4	300284	ATE Ø 11" pneumatisch
 Hauptbremszylinder							
1.4 TSI	90	05/07→11/10		10/07→; +PR 1ZG; für Linkslenker	03.4152-0116.3	010814	ATE Ø 22,2
1.8 TSI	118	05/07→10/11		10/07→; für Linkslenker; +PR 1LJ / 1LK / 1LH / 1LM	03.4153-0186.3	010816	ATE Ø 23,8
				10/07→; +PR 1LJ / 1LK; für Rechtslenker	24.4153-0192.3	011026	ATE Ø 23,8 ohne Bremsflüssigkeitsbehälter
1.4 TSI EcoFuel	110	01/09→11/10		+PR 1ZG; für Linkslenker	03.4152-0116.3	010814	ATE Ø 22,2
1.6	75	08/05→11/10					
1.6 FSI	85	08/05→06/08		+PR 1LJ / 1LK / 1LH / 1LM; für Linkslenker	03.4153-0186.3	010816	ATE Ø 23,8
1.6 TDI	77	08/09→11/10					
1.8 TSI	112	11/09→11/10		+PR 1LJ / 1LK; für Rechtslenker	24.4153-0192.3	011026	ATE Ø 23,8 ohne Bremsflüssigkeitsbehälter
1.9 TDI	77	08/05→11/10					
2.0 BlueTDI	105	01/09→11/10					
2.0 FSI	110	08/05→11/10					
2.0 FSI 4motion	110	09/05→11/10					
2.0 TDI	81	08/05→11/10					
	125						
2.0 TDI 16V	103	08/05→11/10					
2.0 TDI 4motion	125	05/09→11/10					
2.0 TFSI	147	08/05→11/10					
3.2 FSI 4motion	184	11/05→11/10					
3.6 R36 4motion	220	04/07→11/10					
2.0 TDI 16V 4motion	103	08/05→11/10		09/05→; +PR 1ZG; für Linkslenker	03.4152-0116.3	010814	ATE Ø 22,2
2.0 TDI 4motion	103	08/05→05/09		09/05→; +PR 1LJ / 1LK / 1LH / 1LM; für Linkslenker	03.4153-0186.3	010816	ATE Ø 23,8
				09/05→; +PR 1LJ / 1LK; für Rechtslenker	24.4153-0192.3	011026	ATE Ø 23,8 ohne Bremsflüssigkeitsbehälter
VW - PASSAT B7 (362) 08/10→12/15							
 Bremskraftverstärker							
1.4 TSI	90	08/10→12/14		→ 10/14; +PR 1ZG; für Linkslenker	03.7873-4402.4	300292	ATE Ø 11" pneumatisch
1.4 TSI EcoFuel	110	08/10→12/14		→ 10/14; +PR 1LA / 1LB / 1ZM; für Linkslenker	03.7873-4502.4	300284	ATE Ø 11" pneumatisch
1.4 TSI MultiFuel	118	11/10→12/14					
1.6 TDI	77	08/10→12/14					
1.8 TSI	112	08/10→12/14					
	118						
→							

	kw					! #		
VW - PASSAT B7 (362) 08/10→12/15								
 Bremskraftverstärker								
2.0 TDI	100 - 130	08/10→12/14		→ 10/14; +PR 1ZG; für Linkslenker		03.7873-4402.4	300292	ATE Ø 11" pneumatisch
2.0 TDI 4motion	103 - 130	08/10→12/14		→ 10/14; +PR 1LA / 1LB / 1ZM; für Linkslenker		03.7873-4502.4	300284	ATE Ø 11" pneumatisch
2.0 TSI	155	11/10→12/14						
3.6 FSI 4motion	220	01/11→12/14						
2.0 TDI 4motion	125	08/10→01/13		+PR 1ZG; für Linkslenker		03.7873-4402.4	300292	ATE Ø 11" pneumatisch
				+PR 1LA / 1LB / 1ZM; für Linkslenker		03.7873-4502.4	300284	ATE Ø 11" pneumatisch
 Hauptbremszylinder								
1.4 TSI	90 - 118	08/10→12/14		→ 10/14; +PR 1ZG; für Linkslenker		03.4152-0116.3	010814	ATE Ø 22,2
1.4 TSI EcoFuel	110	08/10→12/14		→ 10/14; +PR 1LA / 1LB / 1ZM; für Linkslenker		03.4153-0186.3	010816	ATE Ø 23,8
1.4 TSI MultiFuel	118	11/10→12/14						
1.6 TDI	77	08/10→12/14		→ 10/14; +PR 1LA / 1LB / 1ZM; für Rechtslenker		24.4153-0192.3	011026	ATE Ø 23,8 ohne Bremsflüssigkeitsbehälter
1.8 TSI	112 - 118	08/10→12/14						
2.0 TDI	100 - 130	08/10→12/14						
2.0 TDI 4motion	103 - 130	08/10→12/14						
2.0 TSI	155	11/10→12/14						
3.6 FSI 4motion	220	01/11→12/14						
2.0 TDI 4motion	125	08/10→01/13		+PR 1ZG; für Linkslenker		03.4152-0116.3	010814	ATE Ø 22,2
				+PR 1LA / 1LB / 1ZM; für Linkslenker		03.4153-0186.3	010816	ATE Ø 23,8
				+PR 1LA / 1LB / 1ZM; für Rechtslenker		24.4153-0192.3	011026	ATE Ø 23,8 ohne Bremsflüssigkeitsbehälter
VW - PASSAT B7 (A32, A33) 01/11→12/20								
 Bremskraftverstärker								
2.0 TDI	103	04/11→06/15		→ 10/14; +PR 1ZG; für Linkslenker		03.7873-4402.4	300292	ATE Ø 11" pneumatisch
2.5	125	01/11→12/20		→ 10/14; +PR 1LA / 1LB / 1ZM; für Linkslenker		03.7873-4502.4	300284	ATE Ø 11" pneumatisch
2.0 TDI	110	06/14→12/15		+PR 1ZG; für Linkslenker		03.7873-4402.4	300292	ATE Ø 11" pneumatisch
				+PR 1LA / 1LB / 1ZM; für Linkslenker		03.7873-4502.4	300284	ATE Ø 11" pneumatisch
 Hauptbremszylinder								
2.0 TDI	103	04/11→06/15		→ 10/14; +PR 1ZG; für Linkslenker		03.4152-0116.3	010814	ATE Ø 22,2
2.5	125	01/11→12/20		→ 10/14; +PR 1LA / 1LB / 1ZM; für Linkslenker		03.4153-0186.3	010816	ATE Ø 23,8
				→ 10/14; +PR 1LA / 1LB / 1ZM; für Rechtslenker		24.4153-0192.3	011026	ATE Ø 23,8 ohne Bremsflüssigkeitsbehälter
2.0 TDI	110	06/14→12/15		+PR 1ZG; für Linkslenker		03.4152-0116.3	010814	ATE Ø 22,2
				+PR 1LA / 1LB / 1ZM; für Linkslenker		03.4153-0186.3	010816	ATE Ø 23,8
				+PR 1LA / 1LB / 1ZM; für Rechtslenker		24.4153-0192.3	011026	ATE Ø 23,8 ohne Bremsflüssigkeitsbehälter
VW - PASSAT B7 Kasten/Kombi (365) 08/10→12/14								
 Bremskraftverstärker								
1.4 TSi BlueMotion	90	08/10→12/14		→ 10/14; +PR 1ZG; für Linkslenker		03.7873-4402.4	300292	ATE Ø 11" pneumatisch
1.6 TDI BlueMotion	77	08/10→12/14		→ 10/14; +PR 1LA / 1LB / 1ZM; für Linkslenker		03.7873-4502.4	300284	ATE Ø 11" pneumatisch
1.8 TSI	118	08/10→12/14						
2.0 TDI BlueMotion	103	08/10→12/14						
2.0 TSI	155	11/10→12/14						
3.6 FSi 4motion	220	01/11→12/14						
2.0 TDI BlueMotion	125	08/10→12/14		+PR 1ZG; für Linkslenker		03.7873-4402.4	300292	ATE Ø 11" pneumatisch
				+PR 1LA / 1LB / 1ZM; für Linkslenker		03.7873-4502.4	300284	ATE Ø 11" pneumatisch
 Hauptbremszylinder								
1.4 TSi BlueMotion	90	08/10→12/14		→ 10/14; +PR 1ZG; für Linkslenker		03.4152-0116.3	010814	ATE Ø 22,2
1.6 TDI BlueMotion	77	08/10→12/14		→ 10/14; für Linkslenker; +PR 1LA / 1LB / 1ZM		03.4153-0186.3	010816	ATE Ø 23,8
1.8 TSI	118	08/10→12/14						
2.0 TDI BlueMotion	103	08/10→12/14						
2.0 TSI	155	11/10→12/14		→ 10/14; für Rechtslenker; +PR 1LA / 1LB / 1ZM		24.4153-0192.3	011026	ATE Ø 23,8 ohne Bremsflüssigkeitsbehälter
3.6 FSi 4motion	220	01/11→12/14						
2.0 TDI BlueMotion	125	08/10→12/14		+PR 1ZG; für Linkslenker		03.4152-0116.3	010814	ATE Ø 22,2
				+PR 1LA / 1LB / 1ZM; für Linkslenker		03.4153-0186.3	010816	ATE Ø 23,8
				+PR 1LA / 1LB / 1ZM; für Rechtslenker		24.4153-0192.3	011026	ATE Ø 23,8 ohne Bremsflüssigkeitsbehälter

	kw			 	! #		
VW - PASSAT B7 Variant (365) 08/10→12/15							
 Bremskraftverstärker							
1.4 TSI	90 - 118	08/10→12/14		→ 10/14; +PR 1ZG; für Linkslenker	03.7873-4402.4	300292	ATE Ø 11" pneumatisch
1.4 TSI EcoFuel	110	08/10→12/14		→ 10/14; +PR 1LA / 1LB / 1ZM; für Linkslenker	03.7873-4502.4	300284	ATE Ø 11" pneumatisch
1.4 TSI MultiFuel	118	11/10→12/14					
1.6 TDI	77	08/10→12/14					
1.8 TSI	112 - 118	08/10→12/14					
2.0 TDI	100 - 130	08/10→12/14					
2.0 TDI 4motion	103 - 130	08/10→12/14					
2.0 TSI	155	11/10→12/15					
3.6 FSI 4motion	220	01/11→12/14					
2.0 TDI 4motion	125	08/10→01/13		+PR 1ZG; für Linkslenker	03.7873-4402.4	300292	ATE Ø 11" pneumatisch
				+PR 1LA / 1LB / 1ZM; für Linkslenker	03.7873-4502.4	300284	ATE Ø 11" pneumatisch
 Hauptbremszylinder							
1.4 TSI	90 - 118	08/10→12/14		→ 10/14; +PR 1ZG; für Linkslenker	03.4152-0116.3	010814	ATE Ø 22,2
1.4 TSI EcoFuel	110	08/10→12/14		→ 10/14; +PR 1LA / 1LB / 1ZM; für Linkslenker	03.4153-0186.3	010816	ATE Ø 23,8
1.4 TSI MultiFuel	118	11/10→12/14					
1.6 TDI	77	08/10→12/14					
1.8 TSI	112 - 118	08/10→12/14					
2.0 TDI	100 - 130	08/10→12/14					
2.0 TDI 4motion	103 - 130	08/10→12/14					
2.0 TSI	155	11/10→12/15					
3.6 FSI 4motion	220	01/11→12/14					
2.0 TDI 4motion	125	08/10→01/13		+PR 1ZG; für Linkslenker	03.4152-0116.3	010814	ATE Ø 22,2
				+PR 1LA / 1LB / 1ZM; für Linkslenker	03.4153-0186.3	010816	ATE Ø 23,8
				+PR 1LA / 1LB / 1ZM; für Rechtslenker	24.4153-0192.3	011026	ATE Ø 23,8 ohne Bremsflüssigkeitsbehälter
VW - PASSAT B8 (3G2, CB2) 08/14→							
 Hauptbremszylinder							
1.4 GTE Hybrid	160	06/15→11/18		für Linkslenker; +PR 1ZA / 1ZD	24.4123-1719.3	011017	TRW Ø 23,8 ohne Bremsflüssigkeitsbehälter
1.4 TSI	92 - 110	11/14→					
1.4 TSI 4motion	110	02/15→					
1.5 TSI	110	08/18→					
1.8 TSI	132	02/15→					
2.0 TDI	81 - 147	11/14→					
2.0 TDI 4motion	140 - 147	11/14→					
2.0 TSI	140 - 162	02/15→					
2.0 TSI 4motion	200 - 206	05/15→					
1.6 TDI	88	08/14→					
2.0 TDI 4motion	110 - 176	08/14→		für Linkslenker; +PR 1ZA / 1ZD	24.4123-1719.3	011017	TRW Ø 23,8 ohne Bremsflüssigkeitsbehälter
				11/14→; für Linkslenker; +PR 1ZA / 1ZD	24.4153-1522.3	011048	ATE Ø 23,8 ohne Bremsflüssigkeitsbehälter
VW - PASSAT B8 Variant (3G5, CB5) 08/14→							
 Hauptbremszylinder							
1.4 GTE Hybrid	160	06/15→		für Linkslenker; +PR 1ZA / 1ZD	24.4123-1719.3	011017	TRW Ø 23,8 ohne Bremsflüssigkeitsbehälter
1.4 TSI	92 - 110	11/14→					
1.4 TSI 4motion	110	02/15→					
1.5 TSI	110	08/18→					
1.8 TSI	132	02/15→					
2.0 TDI	81 - 147	11/14→					
2.0 TDI 4motion	140 - 147	11/14→					
2.0 TSI	140	11/18→					
2.0 TSI 4motion	200 - 206	05/15→					
1.6 TDI	88	08/14→					
2.0 TDI 4motion	110 - 176	08/14→		für Linkslenker; +PR 1ZA / 1ZD	24.4123-1719.3	011017	TRW Ø 23,8 ohne Bremsflüssigkeitsbehälter
				11/14→; für Linkslenker; +PR 1ZA / 1ZD	24.4153-1522.3	011048	ATE Ø 23,8 ohne Bremsflüssigkeitsbehälter
2.0 TSI	162	08/14→					

	kw					! #		
VW - PASSAT CC B6 (357) 02/08→01/12								
 Bremskraftverstärker								
1.4 TSI MultiFuel 2.0 TSI	118 155	01/11→01/12 11/10→01/12		→ 09/11; für Linkslenker; +PR 1ZG		03.7873-4402.4	300292	ATE Ø 11" pneumatisch
				→ 09/11; +PR 1LA / 1LB / 1ZM; für Linkslenker		03.7873-4502.4	300284	ATE Ø 11" pneumatisch
1.8 TSI 2.0 TDI	112 120	11/08→05/10 02/08→05/09		für Linkslenker; +PR 1AT / 1ZG		03.7873-4402.4	300292	ATE Ø 11" pneumatisch
				für Linkslenker; +PR 1AT / 1LH / 1LK / 1ZM		03.7873-4502.4	300284	ATE Ø 11" pneumatisch
1.8 TSI 2.0 TDI	118 103 - 125	06/08→01/12 06/08→01/12		→ 05/10; für Linkslenker; +PR 1AT / 1ZG		03.7873-4402.4	300292	ATE Ø 11" pneumatisch
				06/10→ 09/11; für Linkslenker; +PR 1ZG		03.7873-4402.4	300292	ATE Ø 11" pneumatisch
2.0 TDI 4motion 2.0 TFSI	103 - 125 147	08/09→01/12 06/08→01/12		→ 10/10; +PR 1AT / 1LH / 1LK / 1ZM; für Linkslenker		03.7873-4502.4	300284	ATE Ø 11" pneumatisch
				11/10→ 09/11; +PR 1LA / 1LB / 1ZM; für Linkslenker		03.7873-4502.4	300284	ATE Ø 11" pneumatisch
2.0 BlueTDI 2.0 TDI	105 100	05/09→11/10 06/08→05/11		06/10→; +PR 1ZG; für Linkslenker		03.7873-4402.4	300292	ATE Ø 11" pneumatisch
				→ 05/10; für Linkslenker; +PR 1AT / 1ZG		03.7873-4402.4	300292	ATE Ø 11" pneumatisch
				11/10→; +PR 1LA / 1LB / 1ZM; für Linkslenker		03.7873-4502.4	300284	ATE Ø 11" pneumatisch
				→ 10/10; +PR 1AT / 1LH / 1LK / 1ZM; für Linkslenker		03.7873-4502.4	300284	ATE Ø 11" pneumatisch
3.6 FSI 4motion	206	06/08→01/12		→ 10/10; +PR 1AT / 1LH / 1LK / 1ZM; für Linkslenker		03.7873-4502.4	300284	ATE Ø 11" pneumatisch
				11/10→ 09/11; +PR 1LA / 1LB / 1ZM; für Linkslenker		03.7873-4502.4	300284	ATE Ø 11" pneumatisch
3.6 FSI 4motion	220	02/08→12/11		für Linkslenker; +PR 1AT / 1LH / 1LK / 1ZM		03.7873-4502.4	300284	ATE Ø 11" pneumatisch
 Hauptbremszylinder								
1.4 TSI MultiFuel 2.0 TDI 4motion	118 103 - 125	01/11→01/12 08/09→01/12		→ 09/11; +PR 1ZG; für Linkslenker		03.4152-0116.3	010814	ATE Ø 22,2
				→ 09/11; für Linkslenker; +PR 1LH / 1LK / 1ZM		03.4153-0186.3	010816	ATE Ø 23,8
				→ 09/11; für Rechtslenker; +PR 1LH / 1LK / 1ZM		24.4153-0192.3	011026	ATE Ø 23,8 ohne Bremsflüssigkeitsbehälter
1.8 TSI 2.0 BlueTDI 2.0 TDI	112 105 100 - 120	11/08→05/10 05/09→11/10 02/08→05/11		+PR 1ZG; für Linkslenker		03.4152-0116.3	010814	ATE Ø 22,2
				für Linkslenker; +PR 1LH / 1LK		03.4153-0186.3	010816	ATE Ø 23,8
				für Rechtslenker; +PR 1LH / 1LK		24.4153-0192.3	011026	ATE Ø 23,8 ohne Bremsflüssigkeitsbehälter
3.6 FSI 4motion	220	02/08→12/11						
1.8 TSI 2.0 TDI	118 103 - 125	06/08→01/12 06/08→01/12		→ 09/11; +PR 1ZG; für Linkslenker		03.4152-0116.3	010814	ATE Ø 22,2
				→ 09/11; +PR 1LH / 1LK; für Linkslenker		03.4153-0186.3	010816	ATE Ø 23,8
2.0 TFSI 2.0 TSI 3.6 FSI 4motion	147 155 206	06/08→01/12 11/10→01/12 06/08→01/12		→ 09/11; +PR 1LH / 1LK; für Rechtslenker		24.4153-0192.3	011026	ATE Ø 23,8 ohne Bremsflüssigkeitsbehälter
VW - POLO (6N2) 10/99→10/01								
 Bremskraftverstärker								
1.0 1.4 16V 1.4 TDI 1.6 16V GTI 1.7 SDI	37 55 55 92 44	10/99→09/01 10/99→09/01 10/99→09/01 10/99→09/01 10/99→09/01		für Linkslenker; + ESP; +PR 1AT / 1LX / 1ZE / 1ZJ / 1ZK		03.7853-0102.4	300252	ATE Ø 9" pneumatisch
1.4	40 - 44	10/99→09/01		→ 6N-T-300000; für Linkslenker; + ABS		03.7750-6002.4	300134	ATE Ø 9" pneumatisch
1.4 16V 1.9 D 1.9 SDI	74 47 47	10/99→09/01 10/99→09/01 10/99→09/01		für Linkslenker; + ESP; +PR 1AT / 1LX / 1ZE / 1ZJ / 1ZK		03.7853-0102.4	300252	ATE Ø 9" pneumatisch
 Hauptbremszylinder								
1.0 1.7 SDI	37 44	10/99→09/01 10/99→09/01		für Linkslenker; - ABS		03.2120-3943.3	010532	ATE Ø 20,6
				+ ABS		03.2122-1344.3	010593	ATE Ø 22,2
1.4 1.4 16V	40 55	10/99→09/01 10/99→09/01		für Linkslenker; - ABS		03.2120-3943.3	010532	ATE Ø 20,6
1.4 1.9 D 1.9 SDI	44 47 47	10/99→09/01 10/99→09/01 10/99→09/01		für Linkslenker; - ABS		03.2120-3943.3	010532	ATE Ø 20,6
				6N-V-000001→; + ABS		03.2122-1344.3	010593	ATE Ø 22,2
1.4 16V	74	10/99→09/01		→ 6N-T-300000; + ABS		03.2123-1484.3	010595	ATE Ø 23,8
				6N-V-000001→; + ABS		03.2123-1824.3	010596	ATE Ø 23,8
1.4 TDI 1.6 16V GTI	55 92	10/99→09/01 10/99→09/01		+ ABS		03.2123-1824.3	010596	ATE Ø 23,8
Verschlusschraube, Hauptbremszylinder								
1.0 1.4	37 40 - 44	10/99→09/01 10/99→09/01		für Linkslenker; - ABS		03.3517-0101.2	390322	
→								

	kw					! #		
VW - POLO (6N2) 10/99→10/01								
Verschlusschraube, Hauptbremszylinder								
1.4 16V 1.7 SDI 1.9 D 1.9 SDI	55 44 47 47	10/99→09/01 10/99→09/01 10/99→09/01 10/99→09/01		für Linkslenker; - ABS			03.3517-0101.2 390322	
 Bremskraftregler								
1.4 16V	74	10/99→09/01		ausschließlich für Rennsportzwecke			03.6583-0167.3 320140	ATE lastabhängig 8/3 4x
VW - POLO (9N_, 9A_) 10/01→10/14								
 Hauptbremszylinder								
1.2	40	01/02→05/07		9N-5-500001→; - ABS			24.2119-1716.3 011120	FTE Ø 19 ohne Bremsflüssigkeitsbehälter
				- ABS; für Fahrzeuge ohne Servolenkung; → 9N-5-180000			24.2120-1736.3 010732	Ø 20,6
				9N-5-500001→; + ABS			24.2120-1734.3 010702	Ø 20,6
				- ABS; für Fahrzeuge mit Servolenkung; → 9N-5-180000			24.2120-1736.3 010732	Ø 20,6
1.2 1.2 12V 1.8 GTI	44 51 110	05/07→11/09 05/07→11/09 09/05→11/09		→ 05/09; - ABS			24.2119-1716.3 011120	FTE Ø 19 ohne Bremsflüssigkeitsbehälter
				→ 05/09; + ABS			24.2120-1736.3 010732	Ø 20,6
				→ 05/09; + ABS			24.2120-1734.3 010702	Ø 20,6
1.2 12V	47	10/01→07/07		11/01→; - ABS			24.2119-1716.3 011120	FTE Ø 19 ohne Bremsflüssigkeitsbehälter
				11/01→; + ABS			24.2120-1736.3 010732	Ø 20,6
				11/01→; + ABS			24.2120-1734.3 010702	Ø 20,6
1.4	61	08/02→11/09		9N-5-500001→; → 05/09; - ABS			24.2119-1716.3 011120	FTE Ø 19 ohne Bremsflüssigkeitsbehälter
				9N-5-500001→; → 05/09; + ABS			24.2120-1736.3 010732	Ø 20,6
				05/06→; → 9N-5-180000; + ABS			24.2120-1734.3 010702	Ø 20,6
				05/06→; → 9N-5-180000; - ABS			24.2120-1736.3 010732	Ø 20,6
1.4 16V 1.4 TDI	55 - 74 55	10/01→05/08 10/01→06/05		9N-5-500001→; - ABS			24.2119-1716.3 011120	FTE Ø 19 ohne Bremsflüssigkeitsbehälter
				11/01→; + ABS; → 9N-5-180000			24.2120-1734.3 010702	Ø 20,6
				9N-5-500001→; + ABS			24.2120-1734.3 010702	Ø 20,6
				11/01→; - ABS; → 9N-5-180000			24.2120-1736.3 010732	Ø 20,6
1.4 16V 1.4 BiFuel 1.4 TDI	59 60 51 - 59	05/06→11/09 05/06→11/09 04/05→11/09		9N-5-500001→; → 05/09; - ABS			24.2119-1716.3 011120	FTE Ø 19 ohne Bremsflüssigkeitsbehälter
				9N-5-500001→; → 05/09; + ABS			24.2120-1734.3 010702	Ø 20,6
				+ ABS; → 9N-5-180000			24.2120-1734.3 010702	Ø 20,6
				- ABS; → 9N-5-180000			24.2120-1736.3 010732	Ø 20,6
1.4 FSI 1.6 1.6 Flex	63 74 74	02/02→07/06 08/02→05/05 06/08→04/09		9N-5-500001→; - ABS			24.2119-1716.3 011120	FTE Ø 19 ohne Bremsflüssigkeitsbehälter
				+ ABS; → 9N-5-180000			24.2120-1734.3 010702	Ø 20,6
				9N-5-500001→; + ABS			24.2120-1734.3 010702	Ø 20,6
				- ABS; → 9N-5-180000			24.2120-1736.3 010732	Ø 20,6
1.8 GTi Cup Edition	132	05/06→11/09		06/06→ 05/09; - ABS			24.2119-1716.3 011120	FTE Ø 19 ohne Bremsflüssigkeitsbehälter
				06/06→ 05/09; + ABS			24.2120-1736.3 010732	Ø 20,6
				06/06→ 05/09; + ABS			24.2120-1734.3 010702	Ø 20,6
1.9 SDI 1.9 TDI	47 74	10/01→11/09 10/01→11/09		9N-5-500001→; → 05/09; - ABS			24.2119-1716.3 011120	FTE Ø 19 ohne Bremsflüssigkeitsbehälter
				11/01→; + ABS; → 9N-5-180000			24.2120-1736.3 010732	Ø 20,6
				9N-5-500001→; → 05/09; + ABS			24.2120-1734.3 010702	Ø 20,6
				11/01→; - ABS; → 9N-5-180000			24.2120-1736.3 010732	Ø 20,6
 Bremskraftregler								
1.2	40	01/02→05/07		- ABS			03.6583-0216.3 320247	ATE lastabhängig 8/3 4x

VW - POLO III (6N1) 10/94→10/99

Bremskraftverstärker

1.7 SDI	42	04/97→10/99		05/97→; für Linkslenker; + ESP; +PR 1AT / 1LX / 1ZE / 1ZJ / 1ZK	03.7853-0102.4	300252	ATE Ø 9" pneumatisch
100 1.4 16V	74	04/96→10/99		→ 6N-T-300000; für Linkslenker; + ABS	03.7750-6002.4	300134	ATE Ø 9" pneumatisch
55 1.4	40	08/95→10/99		für Linkslenker; + ESP; +PR 1AT / 1LX / 1ZE / 1ZJ / 1ZK	03.7853-0102.4	300252	ATE Ø 9" pneumatisch
60 1.4	44	07/95→10/99					
64 1.9 D	47	10/94→10/99					
64 1.9 SDI	47	07/96→10/99					
75 1.6 4motion	55	08/95→10/99					
120 1.6 16V GTI	88	09/98→10/99		für Linkslenker; + ESP; +PR 1AT / 1LX / 1ZE / 1ZJ / 1ZK	03.7853-0102.4	300252	ATE Ø 9" pneumatisch
50 1.0	37	09/96→10/99		→ 6N-T-300000; für Linkslenker; + ABS	03.7750-6002.4	300134	ATE Ø 9" pneumatisch
60 1.7 SDI	44	08/97→10/99					
75 1.6	55	10/94→10/99		→ 09/99; für Linkslenker; + ESP; +PR 1AT / 1LX / 1ZE / 1ZJ / 1ZK	03.7853-0102.4	300252	ATE Ø 9" pneumatisch

Hauptbremszylinder

1.7 SDI	42	04/97→10/99		05/97→; für Linkslenker; - ABS	03.2120-3943.3	010532	ATE Ø 20,6
				05/97→; + ABS	03.2122-1344.3	010593	ATE Ø 22,2
100 1.4 16V	74	04/96→10/99		→ 6N-T-300000; + ABS	03.2123-1484.3	010595	ATE Ø 23,8
				6N-V-000001→; + ABS	03.2123-1824.3	010596	ATE Ø 23,8
120 1.6 16V GTI	88	09/98→10/99		+ ABS	03.2123-1824.3	010596	ATE Ø 23,8
50 1.0	37	09/96→10/99		für Linkslenker; - ABS	03.2120-3943.3	010532	ATE Ø 20,6
60 1.7 SDI	44	08/97→10/99		+ ABS	03.2122-1344.3	010593	ATE Ø 22,2
55 1.4	40	08/95→10/99		für Linkslenker; - ABS	03.2120-3943.3	010532	ATE Ø 20,6
60 1.4	44	07/95→10/99		für Linkslenker; - ABS	03.2120-3943.3	010532	ATE Ø 20,6
64 1.9 D	47	10/94→10/99		6N-V-000001→; + ABS	03.2122-1344.3	010593	ATE Ø 22,2
64 1.9 SDI	47	07/96→10/99					
75 1.6 4motion	55	08/95→10/99					
75 1.6	55	10/94→10/99		→ 09/99; für Linkslenker; - ABS	03.2120-3943.3	010532	ATE Ø 20,6
				6N-V-000001→; → 09/99; + ABS	03.2122-1344.3	010593	ATE Ø 22,2

Verschlusschraube, Hauptbremszylinder

1.7 SDI	42	04/97→10/99		05/97→; für Linkslenker; - ABS	03.3517-0101.2	390322	
50 1.0	37	09/96→10/99		für Linkslenker; - ABS	03.3517-0101.2	390322	
55 1.4	40	08/95→10/99					
60 1.4	44	07/95→10/99					
60 1.7 SDI	44	08/97→10/99					
64 1.9 D	47	10/94→10/99					
64 1.9 SDI	47	07/96→10/99					
75 1.6 4motion	55	08/95→10/99					
75 1.6	55	10/94→10/99		→ 09/99; für Linkslenker; - ABS	03.3517-0101.2	390322	

Bremskraftregler











100 1.4 16V	74	04/96→10/99		ausschließlich für Rennsportzwecke	03.6583-0167.3	320140	ATE lastabhängig 8/3 4x
-------------	----	-------------	--	------------------------------------	----------------	--------	-------------------------















VW - POLO III CLASSIC (6V2) 01/95→11/09







Bremskraftverstärker









1.6	74	11/02→07/06		für Linkslenker; - ABS	03.7750-6302.4	300161	ATE Ø 9" pneumatisch
1.9 TDI	67	01/97→08/99		für Linkslenker; + ABS; +PR 1KB	10.6350-3902.4	300213	ATE Ø 9" pneumatisch
2.0	85	08/99→09/01		für Linkslenker; + ABS; +PR 1KB	10.6350-3902.4	300213	ATE Ø 9" pneumatisch
90 1.9 TDI	66	09/96→09/01					
1.9 SDI	48	06/96→09/01		für Linkslenker; + ABS; +PR 1KB	10.6350-4002.4	300285	ATE Ø 9" pneumatisch
54 1.4	40	01/98→08/99		für Linkslenker; + ABS; +PR 1KB / 1KM / 1KQ	10.6350-4002.4	300285	ATE Ø 9" pneumatisch
57 1.7 SDI	42	07/97→09/01					
60 1.4	44	12/95→09/01					
64 1.9 SDI	47	12/95→08/99					
75 1.4 16V	55	10/99→09/01					
75 1.6	55	11/95→09/01					
100 1.6	74	12/95→09/01		für Linkslenker; - ABS	03.7750-6302.4	300161	ATE Ø 9" pneumatisch
				05/96→; für Linkslenker; + ABS; +PR 1KB	10.6350-3902.4	300213	ATE Ø 9" pneumatisch
				05/96→; für Linkslenker; + ABS; +PR 1KB / 1KM / 1KQ	10.6350-4002.4	300285	ATE Ø 9" pneumatisch
110 1.9 TDI	81	06/98→01/02		für Linkslenker; - ABS; → 09/01	03.7750-6302.4	300161	ATE Ø 9" pneumatisch
				für Linkslenker; + ABS; → 09/01; +PR 1KB	10.6350-3902.4	300213	ATE Ø 9" pneumatisch
				für Linkslenker; + ABS; → 09/01; +PR 1KB / 1KM / 1KQ	10.6350-4002.4	300285	ATE Ø 9" pneumatisch
68 1.9 SDI	50	08/99→01/02		für Linkslenker; + ABS; → 09/01; +PR 1KB	10.6350-3902.4	300213	ATE Ø 9" pneumatisch
				für Linkslenker; + ABS; → 09/01; +PR 1KB / 1KM / 1KQ	10.6350-4002.4	300285	ATE Ø 9" pneumatisch









→











	kw					! #		
VW - POLO III CLASSIC (6V2) 01/95→11/09								
 Bremskraftverstärker								
90 1.8	66	01/97→09/01		03/98→; für Linkslenker; - ABS		03.7750-6302.4	300161	ATE Ø 9" pneumatisch
				03/98→; für Linkslenker; + ABS; +PR 1KB		10.6350-3902.4	300213	ATE Ø 9" pneumatisch
				03/98→; für Linkslenker; + ABS; +PR 1KK / 1KM / 1KQ		10.6350-4002.4	300285	ATE Ø 9" pneumatisch
 Hauptbremszylinder								
1.6	74	11/02→07/06		für Linkslenker; - ABS		03.2122-1042.3	010137	Ø 22,2
1.9 TDI	67	01/97→08/99		→ 6K-X-523000; für Rechtslenker; - ABS		03.2122-1042.3	010137	Ø 22,2
90 1.9 TDI	66	09/96→09/01		für Linkslenker; + ABS		03.2122-1144.3	010636	ATE Ø 22,2
1.9 SDI	48	06/96→09/01		für Linkslenker; - ABS		03.2120-3943.3	010532	ATE Ø 20,6
54 1.4	40	01/98→08/99		→ 6K-X-523000; für Rechtslenker; - ABS		03.2120-3943.3	010532	ATE Ø 20,6
60 1.4	44	12/95→09/01		für Linkslenker; + ABS		03.2122-1144.3	010636	ATE Ø 22,2
64 1.9 SDI	47	12/95→08/99		für Linkslenker; + ABS		03.2122-1144.3	010636	ATE Ø 22,2
75 1.4 16V	55	10/99→09/01						
100 1.6	74	12/95→09/01		für Linkslenker; - ABS		03.2122-1042.3	010137	Ø 22,2
				→ 6K-X-523000; für Rechtslenker; - ABS		03.2122-1042.3	010137	Ø 22,2
				05/96→; für Linkslenker; + ABS		03.2122-1144.3	010636	ATE Ø 22,2
110 1.9 TDI	81	06/98→01/02		für Linkslenker; - ABS; → 09/01		03.2122-1042.3	010137	Ø 22,2
				→ 6K-X-523000; für Rechtslenker; - ABS		03.2122-1042.3	010137	Ø 22,2
				für Linkslenker; + ABS; → 09/01		03.2122-1144.3	010636	ATE Ø 22,2
2.0	85	08/99→09/01		für Linkslenker; + ABS		03.2122-1144.3	010636	ATE Ø 22,2
57 1.7 SDI	42	07/97→09/01		für Linkslenker; - ABS		03.2120-3943.3	010532	ATE Ø 20,6
				11/97→; → 6K-X-523000; für Rechtslenker; - ABS		03.2120-3943.3	010532	ATE Ø 20,6
				für Linkslenker; + ABS		03.2122-1144.3	010636	ATE Ø 22,2
68 1.9 SDI	50	08/99→01/02		für Linkslenker; - ABS; → 09/01		03.2120-3943.3	010532	ATE Ø 20,6
				→ 6K-X-523000; für Rechtslenker; - ABS		03.2120-3943.3	010532	ATE Ø 20,6
				für Linkslenker; + ABS; → 09/01		03.2122-1144.3	010636	ATE Ø 22,2
75 1.6	55	11/95→09/01		6K-V-022629→ 6K-X-523000; für Rechtslenker; - ABS		03.2120-3943.3	010532	ATE Ø 20,6
				6K-V-022629→; für Linkslenker; - ABS		03.2120-3943.3	010532	ATE Ø 20,6
				→ 6K-V-022628; - ABS		03.2122-1042.3	010137	Ø 22,2
				für Linkslenker; + ABS		03.2122-1144.3	010636	ATE Ø 22,2
90 1.8	66	01/97→09/01		03/98→; für Linkslenker; + ABS		03.2122-1144.3	010636	ATE Ø 22,2
VW - POLO IV Stufenheck (9A4, 9A2, 9N2, 9A6) 09/02→								
 Hauptbremszylinder								
1.0	58	02/03→10/03		9N-5-500001→; - ABS		24.2119-1716.3	011120	FTE Ø 19 ohne Bremsflüssigkeitsbehälter
1.4	74	11/03→06/05				24.2120-1736.3	010732	Ø 20,6
1.4 TDI	55	07/03→06/05		+ ABS; → 9N-5-180000		24.2120-1734.3	010702	Ø 20,6
				9N-5-500001→; + ABS		24.2120-1734.3	010702	Ø 20,6
				- ABS; → 9N-5-180000		24.2120-1736.3	010732	Ø 20,6
1.4	55 - 61	11/02→04/12		9N-5-500001→; → 05/09; - ABS		24.2119-1716.3	011120	FTE Ø 19 ohne Bremsflüssigkeitsbehälter
1.6 Flex	77	05/08→10/14				24.2120-1736.3	010732	Ø 20,6
1.9 SDI	47	09/02→04/12		9N-5-500001→; → 05/09; + ABS		24.2120-1734.3	010702	Ø 20,6
1.9 TDi	74	09/02→		+ ABS; → 9N-5-180000		24.2120-1734.3	010702	Ø 20,6
2.0 Flex	88	10/08→12/14		- ABS; → 9N-5-180000		24.2120-1736.3	010732	Ø 20,6
1.6	74	09/02→		9N-5-500001→; → 05/09; - ABS		24.2119-1716.3	011120	FTE Ø 19 ohne Bremsflüssigkeitsbehälter
						24.2120-1736.3	010732	Ø 20,6
				9N-5-500001→; → 05/09; + ABS		24.2120-1734.3	010702	Ø 20,6
				05/06→; → 9N-5-180000; + ABS		24.2120-1734.3	010702	Ø 20,6
				05/06→; → 9N-5-180000; - ABS		24.2120-1736.3	010732	Ø 20,6
1.6 Flex	76	12/04→10/14		9N-5-500001→; - ABS		24.2119-1716.3	011120	FTE Ø 19 ohne Bremsflüssigkeitsbehälter
1.6 Total Flex	74	10/04→06/06				24.2120-1736.3	010732	Ø 20,6
				05/06→; → 9N-5-180000; + ABS		24.2120-1734.3	010702	Ø 20,6
				9N-5-500001→; + ABS		24.2120-1734.3	010702	Ø 20,6
				05/06→; → 9N-5-180000; - ABS		24.2120-1736.3	010732	Ø 20,6













	kw					! #		
VW - POLO IV Stufenheck (9N2) 09/02→12/10								
 Hauptbremszylinder								
1.9 TDI	74	07/03→12/10		9N-5-500001→; → 05/09; - ABS		24.2119-1716.3	011120	FTE Ø 19 ohne Bremsflüssigkeitsbehälter
						24.2120-1736.3	010732	Ø 20,6
				9N-5-500001→; → 05/09; + ABS		24.2120-1734.3	010702	Ø 20,6
				+ ABS; → 9N-5-180000		24.2120-1734.3	010702	Ø 20,6
				- ABS; → 9N-5-180000		24.2120-1736.3	010732	Ø 20,6
VW - POLO Van Kasten/Kombi (6V5) 12/95→09/01								
 Bremskraftverstärker								
1.4	44 - 55	08/97→09/01		für Linkslenker; +PR 1KB; + ABS		10.6350-3902.4	300213	ATE Ø 9" pneumatisch
1.7 SDI	44	08/97→12/99		für Linkslenker; - ABS		03.7750-6302.4	300161	ATE Ø 9" pneumatisch
				für Linkslenker; +PR 1KB; + ABS		10.6350-3902.4	300213	ATE Ø 9" pneumatisch
 Hauptbremszylinder								
1.4	44 - 55	08/97→09/01		- ABS		03.2122-1042.3	010137	Ø 22,2
1.7 SDI	44	08/97→12/99		für Linkslenker; + ABS		03.2122-1144.3	010636	ATE Ø 22,2
1.9 SDI	47 - 50	12/95→09/01		9N-5-500001→; - ABS		24.2119-1716.3	011120	FTE Ø 19 ohne Bremsflüssigkeitsbehälter
						24.2120-1736.3	010732	Ø 20,6
				+ ABS; → 9N-5-180000		24.2120-1734.3	010702	Ø 20,6
				9N-5-500001→; + ABS		24.2120-1734.3	010702	Ø 20,6
				- ABS; → 9N-5-180000		24.2120-1736.3	010732	Ø 20,6
VW - POLO Van Kasten/Schrägheck (6N1) 09/94→12/99								
 Bremskraftverstärker								
1.0	33	10/94→12/99		→ 6N-T-300000; für Linkslenker; + ABS		03.7750-6002.4	300134	ATE Ø 9" pneumatisch
				→ 09/96; für Linkslenker; + ESP; +PR 1AT / 1LX / 1ZE / 1ZJ / 1ZK		03.7853-0102.4	300252	ATE Ø 9" pneumatisch
 Hauptbremszylinder								
1.0	33	10/94→12/99		→ 09/96; für Linkslenker; - ABS		03.2120-3943.3	010532	ATE Ø 20,6
				6N-V-000001→; → 09/96; + ABS		03.2122-1344.3	010593	ATE Ø 22,2
Verschlusschraube, Hauptbremszylinder								
1.0	33	10/94→12/99		→ 09/96; für Linkslenker; - ABS		03.3517-0101.2	390322	
VW - POLO Variant (6V5) 04/97→09/01								
 Bremskraftverstärker								
1.4	40 - 44	05/97→09/01		für Linkslenker; +PR 1KB; + ABS		10.6350-3902.4	300213	ATE Ø 9" pneumatisch
1.4 16V	55	10/99→09/01						
1.6	55 - 74	05/97→09/01		für Linkslenker; - ABS		03.7750-6302.4	300161	ATE Ø 9" pneumatisch
				für Linkslenker; + ABS		10.6350-3902.4	300213	ATE Ø 9" pneumatisch
1.7 SDI	42	08/97→09/01		für Linkslenker; - ABS		03.7750-6302.4	300161	ATE Ø 9" pneumatisch
1.8	66	05/97→09/01						
1.9 SDI	47 - 50	06/97→09/01		für Linkslenker; +PR 1KB; + ABS		10.6350-3902.4	300213	ATE Ø 9" pneumatisch
1.9 TDI	66 - 81	05/97→09/01						
 Hauptbremszylinder								
1.4	40 - 44	05/97→09/01		- ABS		03.2122-1042.3	010137	Ø 22,2
1.4 16V	55	10/99→09/01		+ ABS; für Linkslenker		03.2122-1144.3	010636	ATE Ø 22,2
1.6	55 - 74	05/97→09/01						
1.7 SDI	42	08/97→09/01						
1.8	66	05/97→09/01						
1.9 SDI	47 - 50	06/97→09/01						
1.9 TDI	66 - 81	05/97→09/01						
VW - SCIROCCO III (137, 138) 05/08→11/17								
 Bremskraftverstärker								
1.4 TSI	90	08/08→11/17		09/08→; für Linkslenker; +PR 1ZK		03.7860-8802.4	300291	ATE Ø 10" pneumatisch
→				09/08→; für Linkslenker; +PR 1ZD / 1ZP		03.7863-3232.4	300307	ATE Ø 10" pneumatisch













	kw			 	! #		
VW - SCIROCCO III (137, 138) 05/08→11/17							
Bremskraftverstärker							
1.4 TSI	90	08/08→11/17		09/08→; für Linkslenker; +PR 1ZA / 1ZE / 1LJ		03.7863-3332.4 300308	ATE Ø 10" pneumatisch
1.4 TSI	92 - 110	11/13→11/17		für Linkslenker; +PR 1ZK		03.7860-8802.4 300291	ATE Ø 10" pneumatisch
2.0 R	188 - 195	11/09→11/17		für Linkslenker; +PR 1ZD / 1ZP		03.7863-3232.4 300307	ATE Ø 10" pneumatisch
2.0 TDI	100 - 135	05/09→11/17		für Linkslenker; +PR 1ZA / 1ZE / 1LJ		03.7863-3332.4 300308	ATE Ø 10" pneumatisch
2.0 TSI	132 - 162	11/09→11/17					
1.4 TSI	118	05/08→11/17		08/08→; +PR 1ZK; für Linkslenker		03.7860-8802.4 300291	ATE Ø 10" pneumatisch
2.0 TFSI	147	05/08→11/09		08/08→; +PR 1ZD / 1ZP; für Linkslenker		03.7863-3232.4 300307	ATE Ø 10" pneumatisch
				08/08→; +PR 1ZA / 1ZE / 1LJ; für Linkslenker		03.7863-3332.4 300308	ATE Ø 10" pneumatisch
2.0 R	206	05/14→11/17		08/14→; für Linkslenker; +PR 1ZK		03.7860-8802.4 300291	ATE Ø 10" pneumatisch
				08/14→; für Linkslenker; +PR 1ZD / 1ZP		03.7863-3232.4 300307	ATE Ø 10" pneumatisch
				08/14→; für Linkslenker; +PR 1ZA / 1ZE / 1LJ		03.7863-3332.4 300308	ATE Ø 10" pneumatisch
2.0 TDI	103	08/08→11/17		10/08→; +PR 1ZK; für Linkslenker		03.7860-8802.4 300291	ATE Ø 10" pneumatisch
				10/08→; +PR 1ZD / 1ZP; für Linkslenker		03.7863-3232.4 300307	ATE Ø 10" pneumatisch
				10/08→; +PR 1ZA / 1ZE / 1LJ; für Linkslenker		03.7863-3332.4 300308	ATE Ø 10" pneumatisch
Hauptbremszylinder							
1.4 TSI	90	08/08→11/17		09/08→; +PR 1ZD / 1ZP; für Linkslenker		03.2122-2129.3 010799	ATE Ø 22,2
				09/08→; +PR 1ZA / 1ZE / 1LJ / 1ZK; für Linkslenker		03.2123-3449.3 010808	ATE Ø 23,8
				09/08→; +PR 1ZD / 1ZP; für Rechtslenker		24.4152-0132.3 011025	ATE Ø 22,2 ohne Bremsflüssigkeitsbehälter
				09/08→; +PR 1ZA / 1ZE / 1LJ / 1ZK; für Rechtslenker		24.4153-0202.3 011027	ATE Ø 23,8 ohne Bremsflüssigkeitsbehälter
1.4 TSI	92 - 110	11/13→11/17		für Linkslenker; +PR 1ZD / 1ZP		03.2122-2129.3 010799	ATE Ø 22,2
2.0 R	188 - 195	11/09→11/17		für Linkslenker; +PR 1ZA / 1ZE / 1LJ / 1ZK		03.2123-3449.3 010808	ATE Ø 23,8
2.0 TDI	100 - 135	05/09→11/17		für Rechtslenker; +PR 1ZD / 1ZP		24.4152-0132.3 011025	ATE Ø 22,2 ohne Bremsflüssigkeitsbehälter
2.0 TSI	132 - 162	11/09→11/17		für Rechtslenker; +PR 1ZA / 1ZE / 1LJ / 1ZK		24.4153-0202.3 011027	ATE Ø 23,8 ohne Bremsflüssigkeitsbehälter
1.4 TSI	118	05/08→11/17		08/08→; +PR 1ZD / 1ZP; für Linkslenker		03.2122-2129.3 010799	ATE Ø 22,2
2.0 TFSI	147	05/08→11/09		08/08→; +PR 1ZA / 1ZE / 1LJ / 1ZK; für Linkslenker		03.2123-3449.3 010808	ATE Ø 23,8
				08/08→; +PR 1ZD / 1ZP; für Rechtslenker		24.4152-0132.3 011025	ATE Ø 22,2 ohne Bremsflüssigkeitsbehälter
				08/08→; +PR 1ZA / 1ZE / 1LJ / 1ZK; für Rechtslenker		24.4153-0202.3 011027	ATE Ø 23,8 ohne Bremsflüssigkeitsbehälter
2.0 R	206	05/14→11/17		08/14→; für Linkslenker; +PR 1ZD / 1ZP		03.2122-2129.3 010799	ATE Ø 22,2
				08/14→; für Linkslenker; +PR 1ZA / 1ZE / 1LJ / 1ZK		03.2123-3449.3 010808	ATE Ø 23,8
				08/14→; für Rechtslenker; +PR 1ZD / 1ZP		24.4152-0132.3 011025	ATE Ø 22,2 ohne Bremsflüssigkeitsbehälter
				08/14→; für Rechtslenker; +PR 1ZA / 1ZE / 1LJ / 1ZK		24.4153-0202.3 011027	ATE Ø 23,8 ohne Bremsflüssigkeitsbehälter
2.0 TDI	103	08/08→11/17		10/08→; +PR 1ZD / 1ZP; für Linkslenker		03.2122-2129.3 010799	ATE Ø 22,2
				10/08→; +PR 1ZA / 1ZE / 1LJ / 1ZK; für Linkslenker		03.2123-3449.3 010808	ATE Ø 23,8
				10/08→; +PR 1ZD / 1ZP; für Rechtslenker		24.4152-0132.3 011025	ATE Ø 22,2 ohne Bremsflüssigkeitsbehälter
				10/08→; +PR 1ZA / 1ZE / 1LJ / 1ZK; für Rechtslenker		24.4153-0202.3 011027	ATE Ø 23,8 ohne Bremsflüssigkeitsbehälter
Drucksensor, Bremskraftverstärker							
1.4 TSI	90	08/08→11/17		09/08→; +PR 1ZD / 1ZP		03.0655-0101.2 370008	ATE
				09/08→; +PR 1ZK		03.0655-0101.2 370008	ATE
				09/08→; für Linkslenker; +PR 1ZA / 1ZE / 1LJ		03.0655-0101.2 370008	ATE
				09/08→; für Rechtslenker; +PR 1ZA / 1ZB / 1ZE / 1LJ		03.0655-0101.2 370008	ATE
1.4 TSI	92 - 110	11/13→11/17		+PR 1ZD / 1ZP		03.0655-0101.2 370008	ATE
2.0 R	188 - 195	11/09→11/17		+PR 1ZK		03.0655-0101.2 370008	ATE
→				für Linkslenker; +PR 1ZA / 1ZE / 1LJ		03.0655-0101.2 370008	ATE











	kw			 	! #		
VW - SCIROCCO III (137, 138) 05/08→11/17							
Drucksensor, Bremskraftverstärker							
2.0 TDI	100 - 135	05/09→11/17		für Rechtslenker; +PR 1ZA / 1ZB / 1ZE / 1LJ	03.0655-0101.2	370008	ATE
2.0 TSI	132 - 162	11/09→11/17					
1.4 TSI	118	05/08→11/17		08/08→; +PR 1ZD / 1ZP	03.0655-0101.2	370008	ATE
2.0 TFSI	147	05/08→11/09		08/08→; +PR 1ZK	03.0655-0101.2	370008	ATE
				08/08→; +PR 1ZA / 1ZE / 1LJ; für Linkslenker	03.0655-0101.2	370008	ATE
				08/08→; +PR 1ZA / 1ZB / 1ZE / 1LJ; für Rechtslenker	03.0655-0101.2	370008	ATE
2.0 R	206	05/14→11/17		08/14→; +PR 1ZK	03.0655-0101.2	370008	ATE
				08/14→; +PR 1ZD / 1ZP	03.0655-0101.2	370008	ATE
				08/14→; für Rechtslenker; +PR 1ZA / 1ZB / 1ZE / 1LJ	03.0655-0101.2	370008	ATE
				08/14→; für Linkslenker; +PR 1ZA / 1ZE / 1LJ	03.0655-0101.2	370008	ATE
2.0 TDI	103	08/08→11/17		10/08→; +PR 1ZD / 1ZP	03.0655-0101.2	370008	ATE
				10/08→; +PR 1ZK	03.0655-0101.2	370008	ATE
				10/08→; +PR 1ZA / 1ZE / 1LJ; für Linkslenker	03.0655-0101.2	370008	ATE
				10/08→; +PR 1ZA / 1ZB / 1ZE / 1LJ; für Rechtslenker	03.0655-0101.2	370008	ATE
VW - SCIROCCO Van (137) 06/08→05/14							
 Bremskraftverstärker							
1.4 TSi	90	08/08→05/14		09/08→; für Linkslenker; +PR 1ZK	03.7860-8802.4	300291	ATE Ø 10" pneumatisch
				09/08→; für Linkslenker; +PR 1ZD / 1ZP	03.7863-3232.4	300307	ATE Ø 10" pneumatisch
				09/08→; für Linkslenker; +PR 1ZA / 1ZE / 1LJ	03.7863-3332.4	300308	ATE Ø 10" pneumatisch
1.4 TSi	118	06/08→05/14		08/08→; +PR 1ZK; für Linkslenker	03.7860-8802.4	300291	ATE Ø 10" pneumatisch
				08/08→; +PR 1ZD / 1ZP; für Linkslenker	03.7863-3232.4	300307	ATE Ø 10" pneumatisch
				08/08→; +PR 1ZA / 1ZE / 1LJ; für Linkslenker	03.7863-3332.4	300308	ATE Ø 10" pneumatisch
2.0 TDi	103	08/08→05/14		10/08→; +PR 1ZK; für Linkslenker	03.7860-8802.4	300291	ATE Ø 10" pneumatisch
				10/08→; +PR 1ZD / 1ZP; für Linkslenker	03.7863-3232.4	300307	ATE Ø 10" pneumatisch
				10/08→; +PR 1ZA / 1ZE / 1LJ; für Linkslenker	03.7863-3332.4	300308	ATE Ø 10" pneumatisch
2.0 TDi	125	05/09→05/14		für Linkslenker; +PR 1ZK	03.7860-8802.4	300291	ATE Ø 10" pneumatisch
2.0 TFSi	155	11/09→05/14		für Linkslenker; +PR 1ZD / 1ZP	03.7863-3232.4	300307	ATE Ø 10" pneumatisch
				für Linkslenker; +PR 1ZA / 1ZE / 1LJ	03.7863-3332.4	300308	ATE Ø 10" pneumatisch
 Hauptbremszylinder							
1.4 TSi	90	08/08→05/14		09/08→; +PR 1ZD / 1ZP; für Linkslenker	03.2122-2129.3	010799	ATE Ø 22,2
				09/08→; +PR 1ZA / 1ZE / 1LJ / 1ZK; für Linkslenker	03.2123-3449.3	010808	ATE Ø 23,8
				09/08→; +PR 1ZD / 1ZP; für Rechtslenker	24.4152-0132.3	011025	ATE Ø 22,2 ohne Bremsflüssigkeitsbehälter
				09/08→; +PR 1ZA / 1ZE / 1LJ / 1ZK; für Rechtslenker	24.4153-0202.3	011027	ATE Ø 23,8 ohne Bremsflüssigkeitsbehälter
1.4 TSi	118	06/08→05/14		08/08→; +PR 1ZD / 1ZP; für Linkslenker	03.2122-2129.3	010799	ATE Ø 22,2
				08/08→; +PR 1ZA / 1ZE / 1LJ / 1ZK; für Linkslenker	03.2123-3449.3	010808	ATE Ø 23,8
				08/08→; +PR 1ZD / 1ZP; für Rechtslenker	24.4152-0132.3	011025	ATE Ø 22,2 ohne Bremsflüssigkeitsbehälter
				08/08→; +PR 1ZA / 1ZE / 1LJ / 1ZK; für Rechtslenker	24.4153-0202.3	011027	ATE Ø 23,8 ohne Bremsflüssigkeitsbehälter
2.0 TDi	103	08/08→05/14		10/08→; +PR 1ZD / 1ZP; für Linkslenker	03.2122-2129.3	010799	ATE Ø 22,2
				10/08→; +PR 1ZA / 1ZE / 1LJ / 1ZK; für Linkslenker	03.2123-3449.3	010808	ATE Ø 23,8
				10/08→; +PR 1ZD / 1ZP; für Rechtslenker	24.4152-0132.3	011025	ATE Ø 22,2 ohne Bremsflüssigkeitsbehälter
				10/08→; +PR 1ZA / 1ZE / 1LJ / 1ZK; für Rechtslenker	24.4153-0202.3	011027	ATE Ø 23,8 ohne Bremsflüssigkeitsbehälter
2.0 TDi	125	05/09→05/14		für Linkslenker; +PR 1ZD / 1ZP	03.2122-2129.3	010799	ATE Ø 22,2
2.0 TFSi	155	11/09→05/14		für Linkslenker; +PR 1ZA / 1ZE / 1LJ / 1ZK	03.2123-3449.3	010808	ATE Ø 23,8
				für Rechtslenker; +PR 1ZD / 1ZP	24.4152-0132.3	011025	ATE Ø 22,2 ohne Bremsflüssigkeitsbehälter
→							











	kw			 	! #		
VW - SCIROCCO Van (137) 06/08→05/14							
 Hauptbremszylinder							
2.0 TDi 2.0 TFSi	125 155	05/09→05/14 11/09→05/14		für Rechtslenker; +PR 1ZA / 1ZE / 1LJ / 1ZK	24.4153-0202.3	011027	ATE Ø 23,8 ohne Bremsflüssigkeitsbehälter
Drucksensor, Bremskraftverstärker							
1.4 TSi	90	08/08→05/14		09/08→; +PR 1ZD / 1ZP	03.0655-0101.2	370008	ATE
				09/08→; +PR 1ZK	03.0655-0101.2	370008	ATE
				09/08→; für Linkslenker; +PR 1ZA / 1ZE / 1LJ	03.0655-0101.2	370008	ATE
				09/08→; für Rechtslenker; +PR 1ZA / 1ZB / 1ZE / 1LJ	03.0655-0101.2	370008	ATE
1.4 TSi	118	06/08→05/14		08/08→; +PR 1ZD / 1ZP	03.0655-0101.2	370008	ATE
				08/08→; +PR 1ZK	03.0655-0101.2	370008	ATE
				08/08→; +PR 1ZA / 1ZE / 1LJ; für Linkslenker	03.0655-0101.2	370008	ATE
				08/08→; +PR 1ZA / 1ZB / 1ZE / 1LJ; für Rechtslenker	03.0655-0101.2	370008	ATE
2.0 TDi	103	08/08→05/14		10/08→; +PR 1ZD / 1ZP	03.0655-0101.2	370008	ATE
				10/08→; +PR 1ZK	03.0655-0101.2	370008	ATE
				10/08→; +PR 1ZA / 1ZE / 1LJ; für Linkslenker	03.0655-0101.2	370008	ATE
				10/08→; +PR 1ZA / 1ZB / 1ZE / 1LJ; für Rechtslenker	03.0655-0101.2	370008	ATE
2.0 TDi 2.0 TFSi	125 155	05/09→05/14 11/09→05/14		+PR 1ZK	03.0655-0101.2	370008	ATE
				+PR 1ZD / 1ZP	03.0655-0101.2	370008	ATE
				für Rechtslenker; +PR 1ZA / 1ZB / 1ZE / 1LJ	03.0655-0101.2	370008	ATE
				für Linkslenker; +PR 1ZA / 1ZE / 1LJ	03.0655-0101.2	370008	ATE
VW - SHARAN (7M8, 7M9, 7M6) 05/95→03/10							
 Bremskraftverstärker							
1.8 T 20V 1.9 TDI 2.0	110 66 85	09/97→03/10 09/95→03/10 09/95→03/10		7M-W-020919→; → 04/00; für Linkslenker	03.7755-1902.4	300138	ATE Ø 9 / 8" pneumatisch
				05/02→; - ESP; für Linkslenker	03.7755-6302.4	300221	ATE Ø 9 / 8" pneumatisch
				05/00→ 04/02; +PR 1AT	03.7755-6302.4	300221	ATE Ø 9 / 8" pneumatisch
				→ 7M-W-060000; für Linkslenker	03.7760-3002.4	300120	ATE Ø 10" pneumatisch
				→ 7M-W-020918; für Rechtslenker	03.7760-3002.4	300120	ATE Ø 10" pneumatisch
				05/00→; für Linkslenker; + ESP; → 7M-3-029999	03.7858-3302.4	300122	ATE Ø 9 / 8" pneumatisch
				7M-3-030000→; + ESP; für Linkslenker	03.7858-9502.4	300205	ATE Ø 9 / 8" pneumatisch
1.9 TDI 2.8 VR6 2.8 VR6 Syncro	81 128 128	09/96→04/00 09/95→04/00 11/96→04/00		7M-W-020919→; für Linkslenker	03.7755-1902.4	300138	ATE Ø 9 / 8" pneumatisch
				→ 7M-W-020918; für Rechtslenker	03.7760-3002.4	300120	ATE Ø 10" pneumatisch
				→ 7M-W-060000; für Linkslenker	03.7760-3002.4	300120	ATE Ø 10" pneumatisch
1.9 TDI 1.9 TDI 4motion	85 85	04/00→03/10 03/00→03/10		05/02→; - ESP; für Linkslenker	03.7755-6302.4	300221	ATE Ø 9 / 8" pneumatisch
				05/00→ 04/02; +PR 1AT	03.7755-6302.4	300221	ATE Ø 9 / 8" pneumatisch
				05/00→; für Linkslenker; + ESP; → 7M-3-029999	03.7858-3302.4	300122	ATE Ø 9 / 8" pneumatisch
				7M-3-030000→; + ESP; für Linkslenker	03.7858-9502.4	300205	ATE Ø 9 / 8" pneumatisch
1.9 TDI 2.0 TDI	96 - 110 100 - 103	11/02→03/10 11/05→03/10		- ESP; für Linkslenker	03.7755-6302.4	300221	ATE Ø 9 / 8" pneumatisch
				+ ESP; für Linkslenker	03.7858-9502.4	300205	ATE Ø 9 / 8" pneumatisch
2.0 16V	110	09/95→02/00		7M-W-020919→; für Linkslenker	03.7755-1902.4	300138	ATE Ø 9 / 8" pneumatisch
				→ 7M-W-060000; für Linkslenker	03.7760-3002.4	300120	ATE Ø 10" pneumatisch
				→ 7M-W-020918; für Rechtslenker	03.7760-3002.4	300120	ATE Ø 10" pneumatisch
				7M-3-030000→; + ESP; für Linkslenker	03.7858-9502.4	300205	ATE Ø 9 / 8" pneumatisch
2.0 LPG	85	04/06→03/10		- ESP; für Linkslenker	03.7755-6302.4	300221	ATE Ø 9 / 8" pneumatisch
				→ 7M-W-060000; für Linkslenker	03.7760-3002.4	300120	ATE Ø 10" pneumatisch
				→ 7M-W-020918; für Rechtslenker	03.7760-3002.4	300120	ATE Ø 10" pneumatisch
				für Linkslenker; + ESP; → 7M-3-029999	03.7858-3302.4	300122	ATE Ø 9 / 8" pneumatisch
				7M-3-030000→; + ESP; für Linkslenker	03.7858-9502.4	300205	ATE Ø 9 / 8" pneumatisch
2.8 V6 24V 2.8 V6 24V 4motion →	150 150	04/00→03/10 04/00→03/10		05/02→; - ESP; für Linkslenker	03.7755-6302.4	300221	ATE Ø 9 / 8" pneumatisch
				→ 04/02; +PR 1AT	03.7755-6302.4	300221	ATE Ø 9 / 8" pneumatisch
				für Linkslenker; + ESP; → 7M-3-029999	03.7858-3302.4	300122	ATE Ø 9 / 8" pneumatisch
				7M-3-030000→; + ESP; für Linkslenker	03.7858-9502.4	300205	ATE Ø 9 / 8" pneumatisch











	kW					! #		
VW - SHARAN (7M8, 7M9, 7M6) 05/95→03/10								
Pedalwegsensor, Bremspedal								
1.8 T 20V 1.9 TDI	110 66 - 85	09/97→03/10 09/95→03/10		7M-3-030364→; für Rechtslenker; + ESP		03.0655-0006.2	370006	ATE
1.9 TDI 4motion 2.0 2.0 16V 2.0 LPG 2.8 V6 24V 2.8 V6 24V 4motion	85 85 110 85 150 150	03/00→03/10 09/95→03/10 09/95→02/00 04/06→03/10 04/00→03/10 04/00→03/10		7M-3-030000→; + ESP; für Linkslenker		03.0655-0006.2	370006	ATE
1.9 TDI 2.0 TDI	96 - 110 100 - 103	11/02→03/10 11/05→03/10		+ ESP; für Linkslenker		03.0655-0006.2	370006	ATE
 Hauptbremszylinder								
1.8 T 20V	110	09/97→03/10		→ 7M-W-020918; + ABS		03.2123-1526.3	010477	Ø 23,8
				→ 7M-W-020918; - ABS		03.2123-1548.3	010478	Ø 23,8
				05/02→; - ESP; für Rechtslenker		03.2125-0332.3	010952	Ø 25,4
				7M-W-020919→; - ESP; → 04/02		03.2125-0332.3	010952	Ø 25,4
				7M-W-020919→; → 04/00; - ABS		03.2125-8404.3	010583	ATE Ø 25,4
				05/00→; + ESP; → 7M-3-029999		03.2125-9604.3	010581	Ø 25,4
1.9 TDI 2.0	66 85	09/95→03/10 09/95→03/10		→ 7M-W-020918; + ABS		03.2123-1526.3	010477	Ø 23,8
				→ 7M-W-020918; - ABS		03.2123-1548.3	010478	Ø 23,8
				05/02→; - ESP; für Rechtslenker; → 05/05		03.2125-0332.3	010952	Ø 25,4
				7M-W-020919→; - ESP; → 04/02		03.2125-0332.3	010952	Ø 25,4
				7M-W-020919→; → 04/00; - ABS		03.2125-8404.3	010583	ATE Ø 25,4
				05/00→; + ESP; → 7M-3-029999		03.2125-9604.3	010581	Ø 25,4
1.9 TDI 2.0 16V 2.8 VR6 2.8 VR6 Syncro	81 110 128 128	09/96→04/00 09/95→02/00 09/95→04/00 11/96→04/00		→ 7M-W-020918; + ABS		03.2123-1526.3	010477	Ø 23,8
				→ 7M-W-020918; - ABS		03.2123-1548.3	010478	Ø 23,8
				7M-W-020919→; - ESP		03.2125-0332.3	010952	Ø 25,4
				7M-W-020919→; - ABS		03.2125-8404.3	010583	ATE Ø 25,4
1.9 TDI 1.9 TDI 4motion	85 85	04/00→03/10 03/00→03/10		05/02→; - ESP; für Rechtslenker; → 05/05		03.2125-0332.3	010952	Ø 25,4
				05/00→; + ESP; → 7M-3-029999		03.2125-9604.3	010581	Ø 25,4
1.9 TDI	96	11/02→03/10		- ESP; für Rechtslenker; → 05/05		03.2125-0332.3	010952	Ø 25,4
2.0 LPG	85	04/06→03/10		→ 7M-W-020918; + ABS		03.2123-1526.3	010477	Ø 23,8
				→ 7M-W-020918; - ABS		03.2123-1548.3	010478	Ø 23,8
				+ ESP; → 7M-3-029999		03.2125-9604.3	010581	Ø 25,4
2.8 V6 24V 2.8 V6 24V 4motion	150 150	04/00→03/10 04/00→03/10		+ ESP; → 7M-3-029999		03.2125-9604.3	010581	Ø 25,4
Verschlusschraube, Hauptbremszylinder								
1.8 T 20V 1.9 TDI	110 66 - 81	09/97→03/10 09/95→03/10		→ 7M-W-020918		03.3517-5100.1	390326	
2.0 2.0 16V 2.0 LPG 2.8 VR6 2.8 VR6 Syncro	85 110 85 128 128	09/95→03/10 09/95→02/00 04/06→03/10 09/95→04/00 11/96→04/00						
VW - SHARAN (7N1, 7N2) 05/10→11/22								
 Bremskraftverstärker								
1.4 TSI 2.0 TDI	110 100 - 103	05/10→11/15 05/10→11/15		07/10→; für Linkslenker		03.7873-4502.4	300284	ATE Ø 11" pneumatisch
2.0 TDI 2.0 TDI 4motion 2.0 TFSI	85 - 130 103 147	05/10→06/22 05/11→11/15 12/10→11/15		für Linkslenker		03.7873-4502.4	300284	ATE Ø 11" pneumatisch
 Hauptbremszylinder								
1.4 TSI 2.0 TDI	110 100 - 103	05/10→11/15 05/10→11/15		07/10→; für Linkslenker		03.4153-0186.3	010816	ATE Ø 23,8
				07/10→; für Rechtslenker		24.4153-0222.3	011047	ATE Ø 23,8 ohne Bremsflüssigkeitsbehälter
1.4 TSI 2.0 TDI	110 85 - 135	05/15→11/22 05/10→06/22		für Linkslenker		03.4153-0186.3	010816	ATE Ø 23,8
				für Rechtslenker		24.4153-0222.3	011047	ATE Ø 23,8 ohne Bremsflüssigkeitsbehälter
2.0 TDI 4motion 2.0 TFSI 2.0 TSI	103 - 135 147 162	05/11→10/20 12/10→11/15 05/15→12/20						











	kw					! #		
VW - SHARAN VAN (7M_) 05/95→03/10								
 Bremskraftverstärker								
1.9 TDI	66 - 96	09/96→03/10		- ESP; für Linkslenker		03.7755-6302.4	300221	ATE Ø 9 / 8" pneumatisch
2.0	85	09/96→07/02		+ ESP; für Linkslenker		03.7858-9502.4	300205	ATE Ø 9 / 8" pneumatisch
2.8 VR6	128	09/96→04/00						
2.8 VR6	150	08/01→05/03		7M-W-020919→; für Linkslenker		03.7755-1902.4	300138	ATE Ø 9 / 8" pneumatisch
				- ESP; für Linkslenker		03.7755-6302.4	300221	ATE Ø 9 / 8" pneumatisch
				→ 7M-W-020918; für Rechtslenker		03.7760-3002.4	300120	ATE Ø 10" pneumatisch
				→ 7M-W-060000; für Linkslenker		03.7760-3002.4	300120	ATE Ø 10" pneumatisch
				+ ESP; für Linkslenker		03.7858-9502.4	300205	ATE Ø 9 / 8" pneumatisch
Pedalwegsensor, Bremspedal								
1.9 TDI	66 - 96	09/96→03/10		+ ESP; für Linkslenker		03.0655-0006.2	370006	ATE
2.0	85	09/96→07/02						
2.8 VR6	128 - 150	09/96→05/03						
 Hauptbremszylinder								
1.9 TDI	66 - 96	09/96→03/10		- ESP; für Rechtslenker		03.2125-0332.3	010952	Ø 25,4
2.0	85	09/96→07/02						
2.8 VR6	128	09/96→04/00						
2.8 VR6	150	08/01→05/03		→ 7M-W-020918; + ABS		03.2123-1526.3	010477	Ø 23,8
				→ 7M-W-020918; - ABS		03.2123-1548.3	010478	Ø 23,8
				7M-W-020919→; - ESP		03.2125-0332.3	010952	Ø 25,4
				7M-W-020919→; - ABS		03.2125-8404.3	010583	ATE Ø 25,4
Verschlusschraube, Hauptbremszylinder								
2.8 VR6	150	08/01→05/03		→ 7M-W-020918		03.3517-5100.1	390326	
VW - SHARAN VAN (7N1, 7N2) 05/10→								
 Bremskraftverstärker								
1.4 TSI	110	05/10→11/15		07/10→; für Linkslenker		03.7873-4502.4	300284	ATE Ø 11" pneumatisch
2.0 TDI	100 - 103	05/10→11/15						
2.0 TDI	85 - 125	08/10→11/15		für Linkslenker		03.7873-4502.4	300284	ATE Ø 11" pneumatisch
2.0 TSI	147	12/10→11/15						
 Hauptbremszylinder								
1.4 TSI	110	05/10→11/15		07/10→; für Linkslenker		03.4153-0186.3	010816	ATE Ø 23,8
2.0 TDI	100 - 103	05/10→11/15		07/10→; für Rechtslenker		24.4153-0222.3	011047	ATE Ø 23,8 ohne Bremsflüssigkeitsbehälter
2.0 TDI	85 - 125	08/10→11/15		für Linkslenker		03.4153-0186.3	010816	ATE Ø 23,8
2.0 TSI	147	12/10→11/15		für Rechtslenker		24.4153-0222.3	011047	ATE Ø 23,8 ohne Bremsflüssigkeitsbehälter
VW - TIGUAN (5N_) 09/07→07/18								
 Bremskraftverstärker								
1.4 TSI	90 - 118	05/08→07/18		für Linkslenker		03.7873-4502.4	300284	ATE Ø 11" pneumatisch
1.4 TSI 4motion	110 - 118	09/07→07/18						
2.0 TDI	81 - 110	03/08→07/18						
2.0 TDI 4motion	100 - 135	11/07→07/18						
2.0 TFSI	147	11/07→07/18						
2.0 TFSI 4motion	125	09/07→07/18						
2.0 TSI 4motion	132 - 155	05/11→07/18						
2.0 TDI 4motion	103	09/07→07/18		11/07→; für Linkslenker		03.7873-4502.4	300284	ATE Ø 11" pneumatisch
2.0 TDI 4motion	125	09/07→07/18		01/08→; für Linkslenker		03.7873-4502.4	300284	ATE Ø 11" pneumatisch
2.0 TFSI 4motion	147	09/07→07/18		02/08→; für Linkslenker		03.7873-4502.4	300284	ATE Ø 11" pneumatisch
 Hauptbremszylinder								
1.4 TSI	90 - 118	05/08→07/18		für Linkslenker		03.4153-0186.3	010816	ATE Ø 23,8
1.4 TSI 4motion	110 - 118	09/07→07/18		für Rechtslenker		24.4153-0192.3	011026	ATE Ø 23,8 ohne Bremsflüssigkeitsbehälter
2.0 TDI	81 - 110	03/08→07/18						
→								











	kw			 	! #		
VW - TIGUAN (5N_) 09/07→07/18							
 Hauptbremszylinder							
2.0 TDI 4motion	100 - 135	11/07→07/18		für Linkslenker		03.4153-0186.3 010816	ATE Ø 23,8
2.0 TFSI	147	11/07→07/18		für Rechtslenker		24.4153-0192.3 011026	ATE Ø 23,8 ohne Bremsflüssigkeitsbehälter
2.0 TFSI 4motion	125	09/07→07/18					
2.0 TSI 4motion	132 - 155	05/11→07/18					
2.0 TDI 4motion	103	09/07→07/18		11/07→; für Linkslenker		03.4153-0186.3 010816	ATE Ø 23,8
				11/07→; für Rechtslenker		24.4153-0192.3 011026	ATE Ø 23,8 ohne Bremsflüssigkeitsbehälter
2.0 TDI 4motion	125	09/07→07/18		01/08→; für Linkslenker		03.4153-0186.3 010816	ATE Ø 23,8
				01/08→; für Rechtslenker		24.4153-0192.3 011026	ATE Ø 23,8 ohne Bremsflüssigkeitsbehälter
2.0 TFSI 4motion	147	09/07→07/18		02/08→; für Linkslenker		03.4153-0186.3 010816	ATE Ø 23,8
				02/08→; für Rechtslenker		24.4153-0192.3 011026	ATE Ø 23,8 ohne Bremsflüssigkeitsbehälter
VW - TIGUAN (AD1, AX1) 01/16→							
 Hauptbremszylinder							
1.4 TSI	92 - 110	01/16→03/22		für Linkslenker; +PR 1ZA / 1ZD		24.4123-1719.3 011017	TRW Ø 23,8 ohne Bremsflüssigkeitsbehälter
1.4 TSI 4motion	110	05/16→07/18					
1.5 TSI	96 - 110	07/18→					
1.6 TDI	85	05/16→06/20					
2.0 TDI	81 - 90	05/16→					
2.0 TDI 4motion	130 - 176	04/16→					
2.0 TSI 4motion	132 - 180	01/16→					
2.0 TSI R 4motion	235	11/20→					
2.0 TDI	110	01/16→07/20		02/16→; für Linkslenker; +PR 1ZA / 1ZD		24.4123-1719.3 011017	TRW Ø 23,8 ohne Bremsflüssigkeitsbehälter
2.0 TDI 4motion	110	01/16→07/20					
VW - TIGUAN Kasten/SUV (AD1) 07/15→							
 Hauptbremszylinder							
TDI BlueMotion	140	01/16→07/20		für Linkslenker; +PR 1ZA / 1ZD		24.4123-1719.3 011017	TRW Ø 23,8 ohne Bremsflüssigkeitsbehälter
VW - TIGUAN VAN (5N_) 09/07→07/18							
 Bremskraftverstärker							
1.4 TSI	90 - 118	05/08→07/18		für Linkslenker		03.7873-4502.4 300284	ATE Ø 11" pneumatisch
1.4 TSI 4motion	118	09/12→07/18					
2.0 TDI	81 - 103	11/09→07/18					
2.0 TDI 4motion	103 - 130	11/07→07/18					
2.0 TSI 4motion	125 - 155	11/09→07/18					
 Hauptbremszylinder							
1.4 TSI	90 - 118	05/08→07/18		für Linkslenker		03.4153-0186.3 010816	ATE Ø 23,8
1.4 TSI 4motion	118	09/12→07/18		für Rechtslenker		24.4153-0192.3 011026	ATE Ø 23,8 ohne Bremsflüssigkeitsbehälter
2.0 TDI	81 - 103	11/09→07/18					
2.0 TDI 4motion	103 - 130	11/07→07/18					
2.0 TSI 4motion	125 - 155	11/09→07/18					
VW - TOUAREG (7LA, 7L6, 7L7) 10/02→01/13							
 Bremskraftverstärker							
2.5 R5 TDI	120 - 128	01/03→05/10		12/06→ 03/10; für Linkslenker; +PR 1LB / 1LE / 1LF		03.7868-3702.4 300208	ATE Ø 10 / 8" pneumatisch
3.0 TDI	155	04/06→05/10					
3.0 V6 TDI	165	11/04→05/10					
3.6 V6 FSI	206	10/05→05/10					
4.2 V8 FSI	257	06/06→05/10					
5.0 V10 TDI	230	10/02→05/10					
3.0 V6 TDI	176	11/07→05/10		→ 03/10; für Linkslenker; +PR 1LB / 1LE / 1LF		03.7868-3702.4 300208	ATE Ø 10 / 8" pneumatisch
5.0 R50 TDI	257	08/07→05/10		01/08→ 03/10; für Linkslenker; +PR 1LB / 1LE / 1LF		03.7868-3702.4 300208	ATE Ø 10 / 8" pneumatisch
→							











	kw			 	! #		
VW - TOUAREG (7LA, 7L6, 7L7) 10/02→01/13							
Pedalwegsensor, Bremspedal							
2.5 R5 TDI	120 - 128	01/03→05/10		→ 11/06		03.0655-0006.2 370006	ATE
3.0 TDI	155	04/06→05/10					
3.0 V6 TDI	165	11/04→05/10					
6.0 W12	331	08/04→05/10					
3.2 V6	162	10/02→11/06		11/02→12/05		03.0655-0006.2 370006	ATE
3.2 V6	177	11/04→11/06		→ 12/05		03.0655-0006.2 370006	ATE
3.6 V6 FSI	206	10/05→05/10		01/06→11/06		03.0655-0006.2 370006	ATE
4.2 V8	228	12/02→11/06				03.0655-0006.2 370006	ATE
5.0 V10 TDI	230	10/02→05/10		11/02→11/06		03.0655-0006.2 370006	ATE
 Hauptbremszylinder							
2.5 R5 TDI	120 - 128	01/03→05/10		für Linkslenker; → 03/10		03.2126-3014.3 010811	ATE Ø 27
3.0 TDI	155	04/06→05/10		für Rechtslenker; → 11/06		24.2126-3032.3 011036	ATE Ø 27 ohne Bremsflüssigkeitsbehälter
3.0 V6 TDI	165	11/04→05/10					
3.0 V6 TDI	176	11/07→05/10		für Linkslenker		03.2126-3014.3 010811	ATE Ø 27
4.2 V8	228	12/02→11/06		für Rechtslenker		24.2126-3032.3 011036	ATE Ø 27 ohne Bremsflüssigkeitsbehälter
3.2 V6	162	10/02→11/06		11/02→; für Linkslenker; → 12/05		03.2126-3014.3 010811	ATE Ø 27
				11/02→; für Rechtslenker		24.2126-3032.3 011036	ATE Ø 27 ohne Bremsflüssigkeitsbehälter
3.2 V6	177	11/04→11/06		für Linkslenker; → 12/05		03.2126-3014.3 010811	ATE Ø 27
				für Rechtslenker		24.2126-3032.3 011036	ATE Ø 27 ohne Bremsflüssigkeitsbehälter
3.6 V6 FSI	206	10/05→05/10		01/06→03/10; für Linkslenker		03.2126-3014.3 010811	ATE Ø 27
				01/06→11/06; für Rechtslenker		24.2126-3032.3 011036	ATE Ø 27 ohne Bremsflüssigkeitsbehälter
4.2 V8 FSI	257	06/06→05/10		12/06→03/10; für Linkslenker		03.2126-3014.3 010811	ATE Ø 27
5.0 R50 TDI	257	08/07→05/10		01/08→03/10; für Linkslenker		03.2126-3014.3 010811	ATE Ø 27
5.0 V10 TDI	230	10/02→05/10		11/02→; für Linkslenker; → 03/10		03.2126-3014.3 010811	ATE Ø 27
				11/02→; für Rechtslenker; → 11/06		24.2126-3032.3 011036	ATE Ø 27 ohne Bremsflüssigkeitsbehälter
6.0 W12	331	08/04→05/10		für Linkslenker; → 11/06		03.2126-3014.3 010811	ATE Ø 27
				für Rechtslenker; → 11/06		24.2126-3032.3 011036	ATE Ø 27 ohne Bremsflüssigkeitsbehälter
VW - TOURAN (1T1, 1T2) 02/03→05/10							
 Bremskraftverstärker							
1.4 TSI	103	02/06→05/10		09/06→; +PR 1AT; für Linkslenker		03.7873-4302.4 300312	ATE Ø 11" pneumatisch
1.4 TSI	125	11/06→05/10		für Linkslenker; +PR 1AT		03.7873-4302.4 300312	ATE Ø 11" pneumatisch
1.4 TSI EcoFuel	110	05/09→05/10					
1.6	75	07/03→05/10					
1.6 BiFuel	75	11/06→05/10					
1.6 FSI	85	02/03→01/07					
1.9 TDI	66 - 77	02/03→05/10					
2.0 EcoFuel	80	02/06→05/09					
2.0 FSI	110	10/03→01/07					
2.0 TDI	103	12/05→05/10					
2.0 TDI 16V	103	08/03→05/10					
2.0 TDI	100	02/03→05/10		08/03→; für Linkslenker; +PR 1AT		03.7873-4302.4 300312	ATE Ø 11" pneumatisch
2.0 TDI	125	12/05→05/10		02/06→; +PR 1AT; für Linkslenker		03.7873-4302.4 300312	ATE Ø 11" pneumatisch
 Hauptbremszylinder							
1.4 TSI	103	02/06→05/10		09/06→; +PR 1ZE / 1ZP; für Linkslenker		03.2122-2129.3 010799	ATE Ø 22,2
				1T-6-100 001→; für Rechtslenker		24.4152-0132.3 011025	ATE Ø 22,2 ohne Bremsflüssigkeitsbehälter
1.4 TSI	125	11/06→05/10		für Linkslenker; +PR 1ZE / 1ZP		03.2122-2129.3 010799	ATE Ø 22,2
1.6	75	07/03→05/10		→ 1T-6-100 000; für Rechtslenker; +PR 1ZE / 1ZP		24.2122-1981.3 011024	ATE Ø 22,2 ohne Bremsflüssigkeitsbehälter
1.6 BiFuel	75	11/06→05/10					
1.9 TDI	66 - 77	02/03→05/10		1T-6-100 001→; für Rechtslenker		24.4152-0132.3 011025	ATE Ø 22,2 ohne Bremsflüssigkeitsbehälter
2.0 EcoFuel	80	02/06→05/09					
2.0 FSI	110	10/03→01/07					
2.0 TDI	103	12/05→05/10					
2.0 TDI 16V	103	08/03→05/10					
1.4 TSI EcoFuel	110	05/09→05/10		für Linkslenker		03.2122-2129.3 010799	ATE Ø 22,2
1.6 FSI	85	02/03→01/07		→ 1T-6-100 000; für Rechtslenker; +PR 1ZE / 1ZP		24.2122-1981.3 011024	ATE Ø 22,2 ohne Bremsflüssigkeitsbehälter
→							

	kw			 	! #		
VW - TOURAN (1T1, 1T2) 02/03→05/10							
 Hauptbremszylinder							
1.4 TSI EcoFuel 1.6 FSI	110 85	05/09→05/10 02/03→01/07		1T-6-100 001→; für Rechtslenker		24.4152-0132.3 011025	ATE Ø 22,2 ohne Bremsflüssigkeitsbehälter
2.0 TDI	100	02/03→05/10		08/03→; für Linkslenker; +PR 1ZE / 1ZP		03.2122-2129.3 010799	ATE Ø 22,2
				08/03→; → 1T-6-100 000; für Rechtslenker; +PR 1ZE / 1ZP		24.2122-1981.3 011024	ATE Ø 22,2 ohne Bremsflüssigkeitsbehälter
				1T-6-100 001→; für Rechtslenker		24.4152-0132.3 011025	ATE Ø 22,2 ohne Bremsflüssigkeitsbehälter
2.0 TDI	125	12/05→05/10		02/06→; für Linkslenker; +PR 1ZE / 1ZP		03.2122-2129.3 010799	ATE Ø 22,2
				02/06→; → 1T-6-100 000; +PR 1ZE / 1ZP; für Rechtslenker		24.2122-1981.3 011024	ATE Ø 22,2 ohne Bremsflüssigkeitsbehälter
				1T-6-100 001→; für Rechtslenker		24.4152-0132.3 011025	ATE Ø 22,2 ohne Bremsflüssigkeitsbehälter
Drucksensor, Bremskraftverstärker							
1.4 TSI	103	02/06→05/10		09/06→; +PR 1AS; für Rechtslenker		03.0655-0101.2 370008	ATE
1.4 TSI 1.4 TSI EcoFuel 1.6 1.6 BiFuel 1.6 FSI 1.9 TDI 77 2.0 EcoFuel 2.0 FSI 2.0 TDI 2.0 TDI 16V	125 110 75 75 85 66 - 77 80 110 103 103	11/06→05/10 05/09→05/10 07/03→05/10 11/06→05/10 02/03→01/07 02/03→05/10 02/06→05/09 10/03→01/07 12/05→05/10 08/03→05/10		für Rechtslenker; +PR 1AS		03.0655-0101.2 370008	ATE
2.0 TDI	100	02/03→05/10		08/03→; für Rechtslenker; +PR 1AS		03.0655-0101.2 370008	ATE
2.0 TDI	125	12/05→05/10		02/06→; +PR 1AS; für Rechtslenker		03.0655-0101.2 370008	ATE
VW - TOURAN (1T3) 05/10→05/15							
 Bremskraftverstärker							
1.2 TSI 1.4 TSI	77 103 - 125	05/10→05/15 05/10→05/15		+PR 1AT; für Linkslenker		03.7873-4302.4 300312	ATE Ø 11" pneumatisch
1.4 TSI EcoFuel 1.6 TDI	110 66 - 77	05/10→05/15 05/10→05/15					
2.0 TDI	81 - 125	05/10→05/15					
2.0 TDI	130	01/13→05/15		für Linkslenker		03.7873-4302.4 300312	ATE Ø 11" pneumatisch
 Hauptbremszylinder							
1.2 TSI 1.4 TSI 1.6 TDI	77 125 66 - 77	05/10→05/15 05/10→05/15 05/10→05/15		für Linkslenker; +PR 1ZE / 1ZP		03.2122-2129.3 010799	ATE Ø 22,2
2.0 TDI	81 - 125	05/10→05/15		→ 1T-6-100 000; für Rechtslenker; +PR 1ZE / 1ZP		24.2122-1981.3 011024	ATE Ø 22,2 ohne Bremsflüssigkeitsbehälter
				1T-6-100 001→; für Rechtslenker		24.4152-0132.3 011025	ATE Ø 22,2 ohne Bremsflüssigkeitsbehälter
1.4 TSI	103	05/10→05/15		für Linkslenker; +PR 1ZE / 1ZP		03.2122-2129.3 010799	ATE Ø 22,2
				1T-6-100 001→; für Rechtslenker		24.4152-0132.3 011025	ATE Ø 22,2 ohne Bremsflüssigkeitsbehälter
1.4 TSI EcoFuel	110	05/10→05/15		für Linkslenker		03.2122-2129.3 010799	ATE Ø 22,2
				→ 1T-6-100 000; für Rechtslenker; +PR 1ZE / 1ZP		24.2122-1981.3 011024	ATE Ø 22,2 ohne Bremsflüssigkeitsbehälter
				1T-6-100 001→; für Rechtslenker		24.4152-0132.3 011025	ATE Ø 22,2 ohne Bremsflüssigkeitsbehälter
2.0 TDI	130	01/13→05/15		für Linkslenker		03.2122-2129.3 010799	ATE Ø 22,2
				für Rechtslenker		24.4152-0132.3 011025	ATE Ø 22,2 ohne Bremsflüssigkeitsbehälter
Drucksensor, Bremskraftverstärker							
1.2 TSI 1.4 TSI 1.4 TSI EcoFuel 1.6 TDI 77 2.0 TDI	77 103 - 125 110 66 - 77 81 - 125	05/10→05/15 05/10→05/15 05/10→05/15 05/10→05/15		für Rechtslenker; +PR 1AS		03.0655-0101.2 370008	ATE









	kw				! #			
VW - TOURAN (5T1) 05/15→								
 Hauptbremszylinder								
1.0 TSI	85	12/18→		für Linkslenker		24.4123-1719.3	011017	TRW Ø 23,8 ohne Bremsflüssigkeitsbehälter
1.2 TSI	81	05/15→						
1.4 TSI	110	05/15→						
1.5 TSI	110	11/18→						
1.6 TDI	81 - 85	05/15→				24.4153-1522.3	011048	ATE Ø 23,8 ohne Bremsflüssigkeitsbehälter
1.8 TSI	132	11/15→						
2.0 TDI	81 - 140	05/15→						
VW - TOURAN VAN (1T1, 1T2) 02/03→05/10								
 Bremskraftverstärker								
1.9 TDI	66 - 77	08/03→05/10		+PR 1AT; für Linkslenker		03.7873-4302.4	300312	ATE Ø 11" pneumatisch
2.0 EcoFuel	80	02/06→11/06						
2.0 FSI	110	05/04→01/07						
2.0 TDi	103	08/03→05/10						
FSI	85	02/03→11/06						
2.0 TDI	100	02/03→05/10		08/03→; für Linkslenker; +PR 1AT		03.7873-4302.4	300312	ATE Ø 11" pneumatisch
 Hauptbremszylinder								
1.9 TDI	66 - 77	08/03→05/10		für Linkslenker; +PR 1ZE / 1ZP		03.2122-2129.3	010799	ATE Ø 22,2
2.0 EcoFuel	80	02/06→11/06		→ 1T-6-100 000; +PR 1ZE / 1ZP; für Rechtslenker		24.2122-1981.3	011024	ATE Ø 22,2 ohne Bremsflüssigkeitsbehälter
2.0 FSI	110	05/04→01/07						
2.0 TDi	103	08/03→05/10		1T-6-100 001→; für Rechtslenker		24.4152-0132.3	011025	ATE Ø 22,2 ohne Bremsflüssigkeitsbehälter
2.0 TDI	100	02/03→05/10		08/03→; für Linkslenker; +PR 1ZE / 1ZP		03.2122-2129.3	010799	ATE Ø 22,2
				08/03→; → 1T-6-100 000; für Rechtslenker; +PR 1ZE / 1ZP		24.2122-1981.3	011024	ATE Ø 22,2 ohne Bremsflüssigkeitsbehälter
				1T-6-100 001→; für Rechtslenker		24.4152-0132.3	011025	ATE Ø 22,2 ohne Bremsflüssigkeitsbehälter
FSI	85	02/03→11/06		für Linkslenker		03.2122-2129.3	010799	ATE Ø 22,2
				→ 1T-6-100 000; +PR 1ZE / 1ZP; für Rechtslenker		24.2122-1981.3	011024	ATE Ø 22,2 ohne Bremsflüssigkeitsbehälter
				1T-6-100 001→; für Rechtslenker		24.4152-0132.3	011025	ATE Ø 22,2 ohne Bremsflüssigkeitsbehälter
Drucksensor, Bremskraftverstärker								
1.9 TDI	66 - 77	08/03→05/10		+PR 1AS; für Rechtslenker		03.0655-0101.2	370008	ATE
2.0 EcoFuel	80	02/06→11/06						
2.0 FSI	110	05/04→01/07						
2.0 TDi	103	08/03→05/10						
FSI	85	02/03→11/06						
2.0 TDI	100	02/03→05/10		08/03→; für Rechtslenker; +PR 1AS		03.0655-0101.2	370008	ATE
VW - TOURAN VAN (1T3) 05/10→05/15								
 Bremskraftverstärker								
1.2 TSI	77	05/10→05/15		für Linkslenker; +PR 1AT		03.7873-4302.4	300312	ATE Ø 11" pneumatisch
1.4 TSI	103 - 125	05/10→05/15						
1.4 TSi EcoFuel	110	05/10→05/15						
1.6 TDI	66 - 77	05/10→05/15						
2.0 TDi	125	05/10→01/13						
2.0 TDI	103	05/10→05/15						
 Hauptbremszylinder								
1.2 TSI	77	05/10→05/15		für Linkslenker; +PR 1ZE / 1ZP		03.2122-2129.3	010799	ATE Ø 22,2
1.4 TSI	103 - 125	05/10→05/15		→ 1T-6-100 000; für Rechtslenker; +PR 1ZE / 1ZP		24.2122-1981.3	011024	ATE Ø 22,2 ohne Bremsflüssigkeitsbehälter
1.4 TSi EcoFuel	110	05/10→05/15						
1.6 TDI	66 - 77	05/10→05/15		1T-6-100 001→; für Rechtslenker		24.4152-0132.3	011025	ATE Ø 22,2 ohne Bremsflüssigkeitsbehälter
2.0 TDi	125	05/10→01/13						
2.0 TDI	103	05/10→05/15						
Drucksensor, Bremskraftverstärker								
1.2 TSI	77	05/10→05/15		für Rechtslenker; +PR 1AS		03.0655-0101.2	370008	ATE
1.4 TSI	103 - 125	05/10→05/15						
1.4 TSi EcoFuel	110	05/10→05/15						
1.6 TDI	66 - 77	05/10→05/15						
2.0 TDi	125	05/10→01/13						
2.0 TDI	103	05/10→05/15						











	kw					! #		
VW - TOURAN VAN (5T1) 05/15→								
 Hauptbremszylinder								
2.0 TDI	90 - 110	11/20→			für Linkslenker		24.4123-1719.3 011017 24.4153-1522.3 011048	TRW Ø 23,8 ohne Bremsflüssigkeitsbehälter ATE Ø 23,8 ohne Bremsflüssigkeitsbehälter
VW - TRANSPORTER T4 Bus (70B, 70C, 7DB, 7DK, 70J, 70K, 7DC, 7DJ) 09/90→08/04								
 Bremskraftverstärker								
1.9 TD 2.0 2.5 2.5 Syncro	50 62 81 81	10/92→04/03 09/90→04/03 09/90→06/03 08/92→04/03			→ 70-S-127805 07/95→; für Rechtslenker; → 70-T-199000 70-T-200001→ 07/95→; für Linkslenker; → 70-T-199000 70-S-127806→; → 06/95	03.7750-7402.4 300084 03.7750-7402.4 300084 03.7755-4202.4 300164 03.7755-4202.4 300164 03.7755-4202.4 300164	300084 300084 300164 300164 300164	ATE Ø 9" pneumatisch ATE Ø 9" pneumatisch ATE Ø 9 / 8" pneumatisch ATE Ø 9 / 8" pneumatisch ATE Ø 9 / 8" pneumatisch
2.4 D 2.5 2.5 Syncro	55 85 85	08/97→04/03 08/96→04/03 07/96→04/03			→ 70-S-127805 für Rechtslenker; → 70-T-199000 70-T-200001→ für Linkslenker; → 70-T-199000	03.7750-7402.4 300084 03.7750-7402.4 300084 03.7755-4202.4 300164 03.7755-4202.4 300164	300084 300084 300164 300164	ATE Ø 9" pneumatisch ATE Ø 9" pneumatisch ATE Ø 9 / 8" pneumatisch ATE Ø 9 / 8" pneumatisch
2.5 TDI 2.5 TDI Syncro 2.8 VR6 2.8 VR 6	65 - 111 75 150 103	09/95→04/03 01/96→04/03 04/00→04/03 11/95→04/00			für Rechtslenker; → 70-T-199000 70-T-200001→ für Linkslenker; → 70-T-199000	03.7750-7402.4 300084 03.7755-4202.4 300164 03.7755-4202.4 300164	300084 300164 300164	ATE Ø 9" pneumatisch ATE Ø 9 / 8" pneumatisch ATE Ø 9 / 8" pneumatisch
 Hauptbremszylinder								
1.9 TD 2.0 2.5 2.5 Syncro	50 62 81 81	10/92→04/03 09/90→04/03 09/90→06/03 08/92→04/03			→ 70-S-127805; für Linkslenker; - ABS 70-S-127806→; + ABS; Herstellereinschränkung nur für TRW-Søttel 70-S-127806→; für Linkslenker; - ABS; Herstellereinschränkung nur für TRW-Søttel 05/96→; - ABS; +PR 1LU; Herstellereinschränkung nur für Ate-Søttel 05/96→; - ESP; Herstellereinschränkung nur für Ate-Søttel 70-Y-027264→; + ESP; Herstellereinschränkung nur für Ate-Søttel	03.2122-1042.3 010137 03.2123-1526.3 010477 03.2123-1548.3 010478 03.2125-8111.3 010479 03.2125-9704.3 010603 03.2125-9704.3 010603	010137 010477 010478 010479 010603 010603	Ø 22,2 Ø 23,8 Ø 23,8 Ø 25,4 ATE Ø 25,4 ATE Ø 25,4
2.4 D 2.5 2.5 Syncro	55 85 85	08/97→04/03 08/96→04/03 07/96→04/03			→ 70-S-127805; für Linkslenker; - ABS 70-S-127806→; + ABS; Herstellereinschränkung nur für TRW-Søttel 70-S-127806→; für Linkslenker; - ABS; Herstellereinschränkung nur für TRW-Søttel - ABS; +PR 1LU; Herstellereinschränkung nur für Ate-Søttel - ESP; Herstellereinschränkung nur für Ate-Søttel 70-Y-027264→; + ESP; Herstellereinschränkung nur für Ate-Søttel	03.2122-1042.3 010137 03.2123-1526.3 010477 03.2123-1548.3 010478 03.2125-8111.3 010479 03.2125-9704.3 010603 03.2125-9704.3 010603	010137 010477 010478 010479 010603 010603	Ø 22,2 Ø 23,8 Ø 23,8 Ø 25,4 ATE Ø 25,4 ATE Ø 25,4
2.5 TDI 2.8 VR6	65 - 111 150	05/98→04/03 04/00→04/03			+ ABS; Herstellereinschränkung nur für TRW-Søttel für Linkslenker; - ABS; Herstellereinschränkung nur für TRW-Søttel - ABS; +PR 1LU; Herstellereinschränkung nur für Ate-Søttel 70-Y-027264→; + ESP; Herstellereinschränkung nur für Ate-Søttel - ESP; Herstellereinschränkung nur für Ate-Søttel	03.2123-1526.3 010477 03.2123-1548.3 010478 03.2125-8111.3 010479 03.2125-9704.3 010603 03.2125-9704.3 010603	010477 010478 010479 010603 010603	Ø 23,8 Ø 23,8 Ø 25,4 ATE Ø 25,4 ATE Ø 25,4
2.5 TDI	75	09/95→04/03			+ ABS; Herstellereinschränkung nur für TRW-Søttel für Linkslenker; - ABS; Herstellereinschränkung nur für TRW-Søttel 05/96→; - ABS; +PR 1LU; Herstellereinschränkung nur für Ate-Søttel 70-Y-027264→; + ESP; Herstellereinschränkung nur für Ate-Søttel 05/96→; - ESP; Herstellereinschränkung nur für Ate-Søttel	03.2123-1526.3 010477 03.2123-1548.3 010478 03.2125-8111.3 010479 03.2125-9704.3 010603 03.2125-9704.3 010603	010477 010478 010479 010603 010603	Ø 23,8 Ø 23,8 Ø 25,4 ATE Ø 25,4 ATE Ø 25,4
2.5 TDI Syncro	75	01/96→04/03			für Linkslenker; - ABS; Herstellereinschränkung nur für TRW-Søttel 05/96→; - ABS; +PR 1LU; Herstellereinschränkung nur für Ate-Søttel	03.2123-1548.3 010478 03.2125-8111.3 010479	010478 010479	Ø 23,8 Ø 25,4
→								











	kw					! #		
VW - TRANSPORTER T4 Bus (70B, 70C, 7DB, 7DK, 70J, 70K, 7DC, 7DJ) 09/90→08/04								
 Hauptbremszylinder								
2.5 TDI Syncro	75	01/96→04/03		05/96→; - ESP; Herstellereinschränkung nur für Ate-Sattel	03.2125-9704.3	010603	ATE Ø 25,4	
				70-Y-027264→; + ESP; Herstellereinschränkung nur für Ate-Sattel	03.2125-9704.3	010603	ATE Ø 25,4	
2.8 VR 6	103	11/95→04/00		+ ABS; Herstellereinschränkung nur für TRW-Sattel	03.2123-1526.3	010477	Ø 23,8	
				für Linkslenker; - ABS; Herstellereinschränkung nur für TRW-Sattel	03.2123-1548.3	010478	Ø 23,8	
				- ABS; +PR 1LU; Herstellereinschränkung nur für Ate-Sattel	03.2125-8111.3	010479	Ø 25,4	
				70-Y-027264→; + ESP; Herstellereinschränkung nur für Ate-Sattel	03.2125-9704.3	010603	ATE Ø 25,4	
				05/96→; - ESP; Herstellereinschränkung nur für Ate-Sattel	03.2125-9704.3	010603	ATE Ø 25,4	
Verschlusschraube, Hauptbremszylinder								
1.9 TD	50	10/92→04/03		→ 70-S-127805; für Linkslenker; - ABS	03.3517-0101.2	390322		
2.0	62	09/90→04/03						
2.4 D	55	08/97→04/03						
2.5	81 - 85	09/90→06/03						
2.5 Syncro	81 - 85	08/92→04/03						
VW - TRANSPORTER T4 Kasten (70A, 70H, 7DA, 7DH) 07/90→04/03								
 Bremskraftverstärker								
1.9 TD	50	10/92→04/03		→ 70-S-127805	03.7750-7402.4	300084	ATE Ø 9" pneumatisch	
2.0	62	07/90→04/03		07/95→; für Rechtslenker; → 70-T-199000	03.7750-7402.4	300084	ATE Ø 9" pneumatisch	
2.5	81	11/90→04/03		70-T-200001→	03.7755-4202.4	300164	ATE Ø 9 / 8" pneumatisch	
				07/95→; für Linkslenker; → 70-T-199000	03.7755-4202.4	300164	ATE Ø 9 / 8" pneumatisch	
				70-S-127806→; → 06/95	03.7755-4202.4	300164	ATE Ø 9 / 8" pneumatisch	
2.4 D	55	08/97→04/03		→ 70-S-127805	03.7750-7402.4	300084	ATE Ø 9" pneumatisch	
2.5	85	08/96→04/03		für Rechtslenker; → 70-T-199000	03.7750-7402.4	300084	ATE Ø 9" pneumatisch	
2.5 Syncro	85	08/96→04/03		70-T-200001→	03.7755-4202.4	300164	ATE Ø 9 / 8" pneumatisch	
				für Linkslenker; → 70-T-199000	03.7755-4202.4	300164	ATE Ø 9 / 8" pneumatisch	
2.5 Syncro	81	11/92→11/01		→ 70-S-127805	03.7750-7402.4	300084	ATE Ø 9" pneumatisch	
				für Rechtslenker; → 70-T-199000	03.7750-7402.4	300084	ATE Ø 9" pneumatisch	
				70-S-127806→	03.7755-4202.4	300164	ATE Ø 9 / 8" pneumatisch	
				70-T-200001→	03.7755-4202.4	300164	ATE Ø 9 / 8" pneumatisch	
				für Linkslenker; → 70-T-199000	03.7755-4202.4	300164	ATE Ø 9 / 8" pneumatisch	
2.5 TDI	65 - 111	09/95→04/03		für Rechtslenker; → 70-T-199000	03.7750-7402.4	300084	ATE Ø 9" pneumatisch	
2.5 TDI Syncro	75	09/95→04/03		70-T-200001→	03.7755-4202.4	300164	ATE Ø 9 / 8" pneumatisch	
2.8 VR6	103 - 150	05/96→04/03		für Linkslenker; → 70-T-199000	03.7755-4202.4	300164	ATE Ø 9 / 8" pneumatisch	
 Hauptbremszylinder								
1.9 TD	50	10/92→04/03		→ 70-S-127805; für Linkslenker; - ABS	03.2122-1042.3	010137	Ø 22,2	
2.0	62	07/90→04/03		70-S-127806→; + ABS; Herstellereinschränkung nur für TRW-Sattel	03.2123-1526.3	010477	Ø 23,8	
2.5	81	11/90→04/03		70-S-127806→; für Linkslenker; - ABS; Herstellereinschränkung nur für TRW-Sattel	03.2123-1548.3	010478	Ø 23,8	
2.5 Syncro	81	11/92→11/01		05/96→; - ABS; +PR 1LU; Herstellereinschränkung nur für Ate-Sattel	03.2125-8111.3	010479	Ø 25,4	
				05/96→; - ESP; Herstellereinschränkung nur für Ate-Sattel	03.2125-9704.3	010603	ATE Ø 25,4	
				70-Y-027264→; + ESP; Herstellereinschränkung nur für Ate-Sattel	03.2125-9704.3	010603	ATE Ø 25,4	
2.4 D	55	08/97→04/03		→ 70-S-127805; für Linkslenker; - ABS	03.2122-1042.3	010137	Ø 22,2	
2.5	85	08/96→04/03		70-S-127806→; + ABS; Herstellereinschränkung nur für TRW-Sattel	03.2123-1526.3	010477	Ø 23,8	
2.5 Syncro	85	08/96→04/03		70-S-127806→; für Linkslenker; - ABS; Herstellereinschränkung nur für TRW-Sattel	03.2123-1548.3	010478	Ø 23,8	
				- ABS; +PR 1LU; Herstellereinschränkung nur für Ate-Sattel	03.2125-8111.3	010479	Ø 25,4	
				- ESP; Herstellereinschränkung nur für Ate-Sattel	03.2125-9704.3	010603	ATE Ø 25,4	
				70-Y-027264→; + ESP; Herstellereinschränkung nur für Ate-Sattel	03.2125-9704.3	010603	ATE Ø 25,4	
→								











	kw					! #					
VW - TRANSPORTER T4 Kasten (70A, 70H, 7DA, 7DH) 07/90→04/03											
 Hauptbremszylinder											
2.5 TDI	65 - 111	12/98→04/03		+ ABS; Herstellereinschränkung nur für TRW-Sattel		03.2123-1526.3	010477	Ø 23,8			
2.8 VR6	103 - 150	05/96→04/03		für Linkslenker; - ABS; Herstellereinschränkung nur für TRW-Sattel		03.2123-1548.3	010478	Ø 23,8			
				- ABS; +PR 1LU; Herstellereinschränkung nur für Ate-Sattel		03.2125-8111.3	010479	Ø 25,4			
				70-Y-027264→; + ESP; Herstellereinschränkung nur für Ate-Sattel		03.2125-9704.3	010603	ATE Ø 25,4			
				- ESP; Herstellereinschränkung nur für Ate-Sattel		03.2125-9704.3	010603	ATE Ø 25,4			
2.5 TDI	75	09/95→04/03		+ ABS; Herstellereinschränkung nur für TRW-Sattel		03.2123-1526.3	010477	Ø 23,8			
				für Linkslenker; - ABS; Herstellereinschränkung nur für TRW-Sattel		03.2123-1548.3	010478	Ø 23,8			
				05/96→; - ABS; +PR 1LU; Herstellereinschränkung nur für Ate-Sattel		03.2125-8111.3	010479	Ø 25,4			
				70-Y-027264→; + ESP; Herstellereinschränkung nur für Ate-Sattel		03.2125-9704.3	010603	ATE Ø 25,4			
2.5 TDI Syncro	75	09/95→04/03		- ESP; Herstellereinschränkung nur für Ate-Sattel		03.2125-9704.3	010603	ATE Ø 25,4			
				für Linkslenker; - ABS; Herstellereinschränkung nur für TRW-Sattel		03.2123-1548.3	010478	Ø 23,8			
				05/96→; - ABS; +PR 1LU; Herstellereinschränkung nur für Ate-Sattel		03.2125-8111.3	010479	Ø 25,4			
				05/96→; - ESP; Herstellereinschränkung nur für Ate-Sattel		03.2125-9704.3	010603	ATE Ø 25,4			
2.5 TDI Syncro	75	09/95→04/03		70-Y-027264→; + ESP; Herstellereinschränkung nur für Ate-Sattel		03.2125-9704.3	010603	ATE Ø 25,4			
				für Linkslenker; - ABS; Herstellereinschränkung nur für TRW-Sattel		03.2123-1548.3	010478	Ø 23,8			
				05/96→; - ABS; +PR 1LU; Herstellereinschränkung nur für Ate-Sattel		03.2125-8111.3	010479	Ø 25,4			
				05/96→; - ESP; Herstellereinschränkung nur für Ate-Sattel		03.2125-9704.3	010603	ATE Ø 25,4			
Verschlusschraube, Hauptbremszylinder											
1.9 TD	50	10/92→04/03		→ 70-S-127805; für Linkslenker; - ABS	03.3517-0101.2	390322					
2.0	62	07/90→04/03									
2.4 D	55	08/97→04/03									
2.5	81 - 85	11/90→04/03									
2.5 Syncro	81 - 85	11/92→04/03									
VW - TRANSPORTER T4 Pritsche/Fahrgestell (70E, 70L, 70M, 7DE, 7DL 07/90→04/03											
 Bremskraftverstärker											
1.9 TD	50	10/92→04/03		→ 70-S-127805	03.7750-7402.4	300084	ATE Ø 9" pneumatisch				
2.0	62	07/90→04/03		07/95→; für Rechtslenker; → 70-T-199000	03.7750-7402.4	300084	ATE Ø 9" pneumatisch				
2.5	81	11/90→04/03		70-T-200001→	03.7755-4202.4	300164	ATE Ø 9 / 8" pneumatisch				
2.5 Syncro	81	11/92→11/01									
								07/95→; für Linkslenker; → 70-T-199000			
								70-S-127806→; → 06/95			
2.4 D	55	08/97→04/03		→ 70-S-127805	03.7750-7402.4	300084	ATE Ø 9" pneumatisch				
2.5	85	08/96→04/03		für Rechtslenker; → 70-T-199000	03.7750-7402.4	300084	ATE Ø 9" pneumatisch				
2.5 Syncro	85	08/96→04/03		70-T-200001→	03.7755-4202.4	300164	ATE Ø 9 / 8" pneumatisch				
				für Linkslenker; → 70-T-199000	03.7755-4202.4	300164	ATE Ø 9 / 8" pneumatisch				
				für Rechtslenker; → 70-T-199000	03.7750-7402.4	300084	ATE Ø 9" pneumatisch				
2.5 TDI	65 - 75	09/95→04/03		70-T-200001→	03.7755-4202.4	300164	ATE Ø 9 / 8" pneumatisch				
2.5 TDI Syncro	75	05/98→04/03		für Linkslenker; → 70-T-199000	03.7755-4202.4	300164	ATE Ø 9 / 8" pneumatisch				
 Hauptbremszylinder											
1.9 TD	50	10/92→04/03		→ 70-S-127805; für Linkslenker; - ABS	03.2122-1042.3	010137	Ø 22,2				
2.0	62	07/90→04/03		70-S-127806→; + ABS; Herstellereinschränkung nur für TRW-Sattel	03.2123-1526.3	010477	Ø 23,8				
2.5	81	11/90→04/03		70-S-127806→; für Linkslenker; - ABS; Herstellereinschränkung nur für TRW-Sattel	03.2123-1548.3	010478	Ø 23,8				
2.5 Syncro	81	11/92→11/01									
								05/96→; - ABS; +PR 1LU; Herstellereinschränkung nur für Ate-Sattel	03.2125-8111.3	010479	Ø 25,4
								05/96→; - ESP; Herstellereinschränkung nur für Ate-Sattel	03.2125-9704.3	010603	ATE Ø 25,4
			70-Y-027264→; + ESP; Herstellereinschränkung nur für Ate-Sattel	03.2125-9704.3	010603	ATE Ø 25,4					
2.4 D	55	08/97→04/03		→ 70-S-127805; für Linkslenker; - ABS	03.2122-1042.3	010137	Ø 22,2				
2.5	85	08/96→04/03		70-S-127806→; + ABS; Herstellereinschränkung nur für TRW-Sattel	03.2123-1526.3	010477	Ø 23,8				
2.5 Syncro	85	08/96→04/03									
→											



	kw					! #		
VW - TRANSPORTER T4 Pritsche/Fahrgestell (70E, 70L, 70M, 7DE, 7DL 07/90→04/03)								
 Hauptbremszylinder								
2.4 D	55	08/97→04/03		70-S-127806→; für Linkslenker; - ABS; Herstellereinschränkung nur für TRW-Sattel		03.2123-1548.3	010478	Ø 23,8
2.5	85	08/96→04/03						
2.5 Syncro	85	08/96→04/03		- ABS; +PR 1LU; Herstellereinschränkung nur für Ate-Sattel		03.2125-8111.3	010479	Ø 25,4
				- ESP; Herstellereinschränkung nur für Ate-Sattel		03.2125-9704.3	010603	ATE Ø 25,4
				70-Y-027264→; + ESP; Herstellereinschränkung nur für Ate-Sattel		03.2125-9704.3	010603	ATE Ø 25,4
2.5 TDI	65	05/98→04/03		+ ABS; Herstellereinschränkung nur für TRW-Sattel		03.2123-1526.3	010477	Ø 23,8
				für Linkslenker; - ABS; Herstellereinschränkung nur für TRW-Sattel		03.2123-1548.3	010478	Ø 23,8
				- ABS; +PR 1LU; Herstellereinschränkung nur für Ate-Sattel		03.2125-8111.3	010479	Ø 25,4
				70-Y-027264→; + ESP; Herstellereinschränkung nur für Ate-Sattel		03.2125-9704.3	010603	ATE Ø 25,4
				- ESP; Herstellereinschränkung nur für Ate-Sattel		03.2125-9704.3	010603	ATE Ø 25,4
2.5 TDI	75	09/95→04/03		+ ABS; Herstellereinschränkung nur für TRW-Sattel		03.2123-1526.3	010477	Ø 23,8
				für Linkslenker; - ABS; Herstellereinschränkung nur für TRW-Sattel		03.2123-1548.3	010478	Ø 23,8
				05/96→; - ABS; +PR 1LU; Herstellereinschränkung nur für Ate-Sattel		03.2125-8111.3	010479	Ø 25,4
				70-Y-027264→; + ESP; Herstellereinschränkung nur für Ate-Sattel		03.2125-9704.3	010603	ATE Ø 25,4
				05/96→; - ESP; Herstellereinschränkung nur für Ate-Sattel		03.2125-9704.3	010603	ATE Ø 25,4
2.5 TDI Syncro	75	05/98→04/03		für Linkslenker; - ABS; Herstellereinschränkung nur für TRW-Sattel		03.2123-1548.3	010478	Ø 23,8
				- ABS; +PR 1LU; Herstellereinschränkung nur für Ate-Sattel		03.2125-8111.3	010479	Ø 25,4
				- ESP; Herstellereinschränkung nur für Ate-Sattel		03.2125-9704.3	010603	ATE Ø 25,4
				70-Y-027264→; + ESP; Herstellereinschränkung nur für Ate-Sattel		03.2125-9704.3	010603	ATE Ø 25,4
Verschlusschraube, Hauptbremszylinder								
1.9 TD	50	10/92→04/03		→ 70-S-127805; für Linkslenker; - ABS		03.3517-0101.2	390322	
2.0	62	07/90→04/03						
2.4 D	55	08/97→04/03						
2.5	81 -	11/90→04/03						
	85							
2.5 Syncro	81 -	11/92→04/03						
	85							
VW - TRANSPORTER T5 Bus (7HB, 7HJ, 7EB, 7EJ) 04/03→08/15								
 Bremskraftverstärker								
1.9 TDI	62 -	04/03→11/09		+PR 1AJ / 1AE / 1AC / 1AR; → 7H-A-050000		03.7765-1002.4	300246	ATE Ø 10 / 9" pneumatisch
	77							
2.0	85	11/03→08/15						
2.0 BiTDI	132	09/09→08/15		+PR 1AK; → 7H-A-050000		03.7868-3702.4	300208	ATE Ø 10 / 8" pneumatisch
2.0 BiTDI 4motion	132	09/09→08/15						
2.0 CNG	85	01/06→08/15						
2.0 TDI	62 -	09/09→08/15						
	103							
2.0 TDI 4motion	103	09/09→08/15						
2.5 TDi	120	11/03→11/09						
2.5 TDI	96 -	04/03→11/09						
	128							
2.5 TDI 4motion	96 -	07/04→11/09						
	128							
VR6 3.2	173	02/04→11/09						
3.2 V6 4motion	173	11/03→12/09		07/04→; +PR 1AJ / 1AE / 1AC / 1AR; → 7H-A-050000		03.7765-1002.4	300246	ATE Ø 10 / 9" pneumatisch
				07/04→; +PR 1AK; → 7H-A-050000		03.7868-3702.4	300208	ATE Ø 10 / 8" pneumatisch
Pedalwegsensor, Bremspedal								
1.9 TDI	62 -	04/03→11/09		+PR 1AT; → 7H-A-050000		03.0655-0006.2	370006	ATE
	77							
2.0	85	11/03→08/15						
2.0 BiTDI	132	09/09→08/15						
2.0 BiTDI 4motion	132	09/09→08/15						
2.0 CNG	85	01/06→08/15						
2.0 TDI	62 -	09/09→08/15						
	103							
→								

	kW			 	! #		
VW - TRANSPORTER T5 Bus (7HB, 7HJ, 7EB, 7EJ) 04/03→08/15							
Pedalwegsensord, Bremspedal							
2.0 TDI 4motion	103	09/09→08/15		+PR 1AT; → 7H-A-050000		03.0655-0006.2 370006	ATE
2.5 TDi	120	11/03→11/09					
2.5 TDI	96 - 128	04/03→11/09					
2.5 TDI 4motion	96 - 128	07/04→11/09					
VR6 3.2	173	02/04→11/09					
3.2 V6 4motion	173	11/03→12/09		07/04→; +PR 1AT; → 7H-A-050000		03.0655-0006.2 370006	ATE
 Hauptbremszylinder							
1.9 TDI	62 - 77	04/03→11/09		→ 7H-A-050000		03.2126-3014.3 010811	ATE Ø 27
2.0	85	11/03→08/15		7H-6-000001→ 7H-6-200000; für Rechtslenker; +PR 1AT		03.2126-3014.3 010811	ATE Ø 27
2.0 CNG	85	01/06→08/15					
VR6 3.2	173	02/04→11/09		7H-A-200001→		03.2126-3144.3 010941	ATE Ø 27
2.0 BiTDI	132	09/09→08/15		→ 7H-A-050000		03.2126-3014.3 010811	ATE Ø 27
2.0 BiTDI 4motion	132	09/09→08/15					
2.0 TDI	62 - 103	09/09→08/15		7H-A-200001→		03.2126-3144.3 010941	ATE Ø 27
2.0 TDI 4motion	100 - 103	09/09→08/15					
2.5 TDi	120	11/03→11/09					
2.5 TDI	96 - 128	04/03→11/09					
2.5 TDI 4motion	96 - 128	07/04→11/09					
2.0 TDI	84 - 85	05/11→08/15				03.2126-3144.3 010941	ATE Ø 27
2.0 TSI	110 - 150	05/11→08/15					
2.0 TSI 4motion	150	07/11→08/15					
3.2 V6 4motion	173	11/03→12/09		07/04→; → 7H-A-050000		03.2126-3014.3 010811	ATE Ø 27
				7H-A-200001→		03.2126-3144.3 010941	ATE Ø 27
VW - TRANSPORTER T5 Kasten (7HA, 7HH, 7EA, 7EH) 04/03→							
 Bremskraftverstärker							
1.9 TDI	62 - 77	04/03→11/09		+PR 1AJ / 1AE / 1AC / 1AR; → 7H-A-050000		03.7765-1002.4 300246	ATE Ø 10 / 9" pneumatisch
2.0	85	11/03→08/15					
2.0 BiFuel	85	06/07→08/15		+PR 1AK; → 7H-A-050000		03.7868-3702.4 300208	ATE Ø 10 / 8" pneumatisch
2.0 BiTDI	132	09/09→08/15					
2.0 BiTDI 4motion	132	09/09→08/15					
2.0 TDI	62 - 103	09/09→08/15					
2.0 TDI 4motion	103	09/09→08/15					
2.5 TDI	96 - 128	04/03→11/09					
2.5 TDI 4motion	96 - 128	07/04→11/09					
VR6 3.2	173	02/04→11/09					
VR6 3.2 4motion	173	11/03→11/09		07/04→; +PR 1AJ / 1AE / 1AC / 1AR; → 7H-A-050000		03.7765-1002.4 300246	ATE Ø 10 / 9" pneumatisch
				07/04→; +PR 1AK; → 7H-A-050000		03.7868-3702.4 300208	ATE Ø 10 / 8" pneumatisch
Pedalwegsensord, Bremspedal							
1.9 TDI	62 - 77	04/03→11/09		+PR 1AT; → 7H-A-050000		03.0655-0006.2 370006	ATE
2.0	85	11/03→08/15					
2.0 BiFuel	85	06/07→08/15					
2.0 BiTDI	132	09/09→08/15					
2.0 BiTDI 4motion	132	09/09→08/15					
2.0 TDI	62 - 103	09/09→08/15					
2.0 TDI 4motion	103	09/09→08/15					
2.5 TDI	96 - 128	04/03→11/09					
2.5 TDI 4motion	96 - 128	07/04→11/09					
VR6 3.2	173	02/04→11/09					
VR6 3.2 4motion	173	11/03→11/09		07/04→; +PR 1AT; → 7H-A-050000		03.0655-0006.2 370006	ATE
 Hauptbremszylinder							
1.9 TDI	62 - 77	04/03→11/09		→ 7H-A-050000		03.2126-3014.3 010811	ATE Ø 27
2.0	85	11/03→08/15		7H-6-000001→ 7H-6-200000; für Rechtslenker; +PR 1AT		03.2126-3014.3 010811	ATE Ø 27
2.0 BiFuel	85	06/07→08/15					
VR6 3.2	173	02/04→11/09		7H-A-200001→		03.2126-3144.3 010941	ATE Ø 27
2.0 BiTDI	132	09/09→08/15		→ 7H-A-050000		03.2126-3014.3 010811	ATE Ø 27
2.0 BiTDI 4motion	132	09/09→08/15					
→							

	kw			 	! #		
VW - TRANSPORTER T5 Kasten (7HA, 7HH, 7EA, 7EH) 04/03→							
 Hauptbremszylinder							
2.0 TDI	62 - 103	09/09→08/15		7H-A-200001→		03.2126-3144.3 010941	ATE Ø 27
2.0 TDI 4motion	100 - 103	09/09→08/15					
2.5 TDI	96 - 128	04/03→11/09					
2.5 TDI 4motion	96 - 128	07/04→11/09					
2.0 TDI	84	05/11→08/15				03.2126-3144.3 010941	ATE Ø 27
2.0 TSI	110 - 150	05/11→08/15					
2.0 TSI 4motion	150	07/11→08/15					
VR6 3.2 4motion	173	11/03→11/09		07/04→; → 7H-A-050000		03.2126-3014.3 010811	ATE Ø 27
				7H-A-200001→		03.2126-3144.3 010941	ATE Ø 27
VW - TRANSPORTER T5 Pritsche/Fahrgestell (7JD, 7JE, 7JL, 7JY, 7JZ 04/03→08/15							
 Bremskraftverstärker							
1.9 TDI	62 - 77	04/03→11/09		→ 7J-A-010000; +PR 1AJ / 1AE / 1AC / 1AR		03.7765-1002.4 300246	ATE Ø 10 / 9" pneumatisch
2.0	85	11/03→05/13					
2.0 BiTDI	132	09/09→08/15		→ 7J-A-010000; +PR 1AK		03.7868-3702.4 300208	ATE Ø 10 / 8" pneumatisch
2.0 BiTDI 4motion	132	09/09→08/15					
2.0 CNG	85	11/03→05/11					
2.0 TDI	62 - 103	09/09→08/15					
2.0 TDI 4motion	103	09/09→08/15					
2.5 TDI	96 - 128	04/03→11/09					
2.5 TDI 4motion	96	07/04→11/09					
VR6 3.2	173	08/03→11/09					
2.5 TDI 4motion	128	04/04→11/09		07/04→; → 7J-A-010000; +PR 1AJ / 1AE / 1AC / 1AR		03.7765-1002.4 300246	ATE Ø 10 / 9" pneumatisch
				07/04→; → 7J-A-010000; +PR 1AK		03.7868-3702.4 300208	ATE Ø 10 / 8" pneumatisch
Pedalwegsensoren, Bremspedal							
1.9 TDI	62 - 77	04/03→11/09		→ 7J-A-010000; +PR 1AT		03.0655-0006.2 370006	ATE
2.0	85	11/03→05/13					
2.0 BiTDI	132	09/09→08/15					
2.0 BiTDI 4motion	132	09/09→08/15					
2.0 CNG	85	11/03→05/11					
2.0 TDI	62 - 103	09/09→08/15					
2.0 TDI 4motion	103	09/09→08/15					
2.5 TDI	96 - 128	04/03→11/09					
2.5 TDI 4motion	96	07/04→11/09					
VR6 3.2	173	08/03→11/09					
2.5 TDI 4motion	128	04/04→11/09		07/04→; → 7J-A-010000; +PR 1AT		03.0655-0006.2 370006	ATE
 Hauptbremszylinder							
1.9 TDI	62 - 77	04/03→11/09		→ 7J-A-010000		03.2126-3014.3 010811	ATE Ø 27
2.0	85	11/03→05/13					
2.0 BiTDI	132	09/09→08/15		7J-A-200001→		03.2126-3144.3 010941	ATE Ø 27
2.0 BiTDI 4motion	132	09/09→08/15					
2.0 CNG	85	11/03→05/11					
2.0 TDI	62 - 103	09/09→08/15					
2.0 TDI 4motion	103	09/09→08/15					
2.5 TDI	96 - 128	04/03→11/09					
2.5 TDI 4motion	96	07/04→11/09					
VR6 3.2	173	08/03→11/09					
2.0 TDI	84 - 100	05/10→08/15				03.2126-3144.3 010941	ATE Ø 27
2.0 TDI 4motion	100	05/10→08/15					
2.0 TSI	110	07/12→08/15					
2.5 TDI 4motion	128	04/04→11/09		07/04→; → 7J-A-010000		03.2126-3014.3 010811	ATE Ø 27
				7J-A-200001→		03.2126-3144.3 010941	ATE Ø 27
VW - T-ROC (A11, D11) 07/17→							
 Hauptbremszylinder							
1.0 TSI	81 - 85	07/17→		für Linkslenker		24.4153-1522.3 011048	ATE Ø 23,8 ohne Bremsflüssigkeitsbehälter
1.5 TSI	110	11/17→					
1.5 TSI 4motion	110	05/18→11/19					
→							

	kW			 	! #		
VW - T-ROC (A11, D11) 07/17→							
 Hauptbremszylinder							
1.6 TDI 2.0 R 4motion 2.0 TDI 2.0 TDI 4motion 2.0 TDI SCR 2.0 TSI 4motion	85 221 110 110 - 140 85 140	03/18→06/21 09/19→ 03/18→ 09/17→ 11/20→ 07/17→		für Linkslenker		24.4153-1522.3 011048	ATE Ø 23,8 ohne Bremsflüssigkeitsbehälter
VW - T-ROC Cabriolet (AC7, AC8) 12/19→							
 Hauptbremszylinder							
1.0 TSI 1.5 TSI	81 - 85 110	12/19→ 12/19→		für Linkslenker		24.4153-1522.3 011048	ATE Ø 23,8 ohne Bremsflüssigkeitsbehälter
VW - UP! (121, 122, BL1, BL2, BL3, 123) 08/11→							
 Hauptbremszylinder							
1.0	44 - 55	08/11→08/20		12/11→; für Linkslenker		24.4120-1703.3 011015	TRW Ø 20,6 ohne Bremsflüssigkeitsbehälter
1.0 1.0 EcoFuel 1.0 GTI 1.0 TSI	48 50 85 66	08/20→ 11/12→ 11/17→ 05/16→09/18		für Linkslenker		24.4120-1703.3 011015	TRW Ø 20,6 ohne Bremsflüssigkeitsbehälter



DE Technische Übersetzungen

EN Technical translations

ES Traducciones técnicas

FR Traductions techniques





IT Traduzioni tecniche

2024



Technische Übersetzungen

Technical translations - Traducciones tecnicas - Traductions techniques - Traduzioni tecniche

DE		DE	
	Hauptbremszylinder	Ausstattungs-Code	Ausstattungs-Code
	Bremskraftregler	Automatikgetriebe	Automatikgetriebe
	Bremskraftverstärker	BDX	Bremssystem, Bendix
	links	Bördelform	Bördelform
+ ABS	für Fahrzeuge mit ABS	BOS	Bremssystem, Bosch
+ ASC	für Fahrzeuge mit ASC	Bosnien-Herzegowina	Bosnien-Herzegowina
+ ASR	für Fahrzeuge mit ASR	Bremskraftverstärker	Bremskraftverstärker
+ DSC	für Fahrzeuge mit DSC	Brems-system	Bremssystem
+ DSTC	für Fahrzeuge mit DSTC	CVT-Automatikgetriebe (stufenlos)	CVT-Automatikgetriebe (stufenlos)
+ EDS	für Fahrzeuge mit EDS	DEL	Bremssystem, Delco
+ ESP	für Fahrzeuge mit ESP	- Diff	ohne Differentialsperre
+ Performance Parts	für Fahrzeuge mit Performance Bremse	- DSC	für Fahrzeuge ohne DSC
+PR	für PR-Nummer	- DSTC	für Fahrzeuge ohne DSTC
+ RO	Rumänien	E	E
+SA	für SA Code	empty/leer	Montageinformation beachten
+ TR	Türkei	Erfüllte Qualitätsstufen	Erfüllte Qualitätsstufen
12Q	12Q	- ESP	für Fahrzeuge ohne ESP
14Q	14Q	F	F
16Q	16Q	Fahrzeugproduktionsland	Fahrzeugproduktionsland
2019	2019	Felge Lochzahl	Felge Lochzahl
20Q	20Q	Felgengröße [Zoll]	Felgengröße [Zoll]
Abfrage Produktbild vorhanden	Abfrage Produktbild vorhanden	Frankreich	Frankreich
- ABS	für Fahrzeuge ohne ABS	für DAM-Nummer ab →	für DAM-Nummer ab
Aluguss	Aluguss	für Fahr-schulwagen	für Fahrschulwagen
Artikelnummer des empfohlenen Zubehörs	Artikelnummer des empfohlenen Zubehörs	für Fahr-zeuge mit Adaptive Cruise Control	für Fahrzeuge mit Adaptive Cruise Control
- ASC	für Fahrzeuge ohne ASC		
- ASR	für Fahrzeuge ohne ASR		
ausschließlich für Rennsportzwecke	ausschließlich für Rennsportzwecke		



Technische Übersetzungen

Technical translations - Traducciones técnicas - Traductions techniques - Traduzioni tecniche

DE		DE	
für Fahrzeuge mit AMG-Sportpaket	für Fahrzeuge mit AMG-Sportpaket	für Fahrzeuge mit Sportpaket	für Fahrzeuge mit Sportpaket
für Fahrzeuge mit autom. Distanzregelung	für Fahrzeuge mit autom. Distanzregelung	für Fahrzeuge mit Start-Stopp-Funktion	für Fahrzeuge mit Start-Stopp-Funktion
für Fahrzeuge mit Bremsassistent	für Fahrzeuge mit Bremsassistent	für Fahrzeuge mit STC	für Fahrzeuge mit STC
für Fahrzeuge mit elektr. Dämpferregulierung	für Fahrzeuge mit elektr. Dämpferregulierung	für Fahrzeuge mit Trommelbremse an der Hinterachse	für Fahrzeuge mit Trommelbremse an der Hinterachse
für Fahrzeuge mit elektronischer Fahrdynamikregelung	für Fahrzeuge mit elektronischer Fahrdynamikregelung	für Fahrzeuge mit verstärktem Fahrwerk	für Fahrzeuge mit verstärktem Fahrwerk
für Fahrzeuge mit Kollisionswarner	für Fahrzeuge mit Kollisionswarner	für Fahrzeuge mit verstärkter Bremse	für Fahrzeuge mit verstärkter Bremse
für Fahrzeuge mit M-Sportbremse	für Fahrzeuge mit M-Sportbremse	für Fahrzeuge ohne Adaptive Cruise Control	für Fahrzeuge ohne Adaptive Cruise Control
für Fahrzeuge mit Rußpartikelfilter	für Fahrzeuge mit Rußpartikelfilter	für Fahrzeuge ohne Aktivlenkung	für Fahrzeuge ohne Aktivlenkung
für Fahrzeuge mit Scheibenbremse an der Hinterachse	für Fahrzeuge mit Scheibenbremse an der Hinterachse	für Fahrzeuge ohne AMG-Sportpaket	für Fahrzeuge ohne AMG-Sportpaket
für Fahrzeuge mit Servolenkung	für Fahrzeuge mit Servolenkung	für Fahrzeuge ohne autom. Distanzregelung	für Fahrzeuge ohne autom. Distanzregelung
für Fahrzeuge mit Sportfahrwerk	für Fahrzeuge mit Sportfahrwerk	für Fahrzeuge ohne Bremsassistent	für Fahrzeuge ohne Bremsassistent
		für Fahrzeuge ohne elektronische Fahrdynamikregelung	für Fahrzeuge ohne elektronische Fahrdynamikregelung

Technische Übersetzungen

Technical translations - Traducciones técnicas - Traductions techniques - Traduzioni tecniche

DE		DE	
für Fahrzeuge ohne Keramikbremse	für Fahrzeuge ohne Keramikbremse	für verlängerten Radstand	für verlängerten Radstand
für Fahrzeuge ohne Kollisionswarner	für Fahrzeuge ohne Kollisionswarner	Gebrauchsnummer	Gebrauchsnummer
für Fahrzeuge ohne M-Sportbremse	für Fahrzeuge ohne M-Sportbremse	Getriebeautomatik 6 Gang	Getriebeautomatik 6 Gang
für Fahrzeuge ohne Servolenkung	für Fahrzeuge ohne Servolenkung	Gewindemaß 1	Gewindemaß 1
für Fahrzeuge ohne Sportfahrwerk	für Fahrzeuge ohne Sportfahrwerk	Gewindemaß 2	Gewindemaß 2
für Fahrzeuge ohne Sportpaket	für Fahrzeuge ohne Sportpaket	GG	Bremssattel aus Gusseisen
für Fahrzeuge ohne Start-Stopp-Funktion	für Fahrzeuge ohne Start-Stopp-Funktion	Herstellereinschränkung	Herstellereinschränkung
für Fahrzeuge ohne STC	für Fahrzeuge ohne STC	hyd.	Hydraulisch
für Fahrzeuge ohne verstärktes Fahrwerk	für Fahrzeuge ohne verstärktes Fahrwerk	Kroatien	Kroatien
für Kolben-Ø [mm]	für Kolben-Ø [mm]	L=	Länge [mm]
für Linkslenker	für Linkslenker	L=	Länge über Alles [mm]
für Modellreihenbaumuster	für Modellreihenbaumuster	L1=	Länge 1 [mm]
für OE-Nummer	für OE-Nummer	L2=	Länge 2 [mm]
für Rechtslenker	für Rechtslenker	Länderspezifische Verpackungs- und Status-Informationen	Länderspezifische Verpackungs- und Status-Informationen
für verkürzten Radstand	für verkürzten Radstand	lastabhängig	lastabhängig
		mit Bremsflüssigkeitsbehälter	mit Bremsflüssigkeitsbehälter
		mm Radnabendurchmesser [mm]	Radnabendurchmesser [mm]
		Motorcode	Motorcode
		Nicht erfüllte Qualitätsstufen	Nicht erfüllte Qualitätsstufen
		nicht für Facelift	nicht für Facelift
		nicht für Fahrschulwagen	nicht für Fahrschulwagen
		nicht für Fahrzeuge mit verstärkter Bremse	nicht für Fahrzeuge mit verstärkter Bremse







Technische Übersetzungen

Technical translations - Traducciones tecnicas - Traductions techniques - Traduzioni tecniche

DE		DE	
nicht für gepanzerte Fahrzeuge	nicht für gepanzerte Fahrzeuge	Schaltgetriebe, automatisch betätigt	Schaltgetriebe, automatisch betätigt
nicht für Sonderfahrzeuge	nicht für Sonderfahrzeuge	Schaltgetriebe 6 Gang	Schaltgetriebe 6 Gang
Nutzlast [kg]	Nutzlast [kg]	Scheibenbremse	Scheibenbremse
Nutzlast ab [kg]	Nutzlast ab [kg]	Schlüsselweite 1 [mm]	Schlüsselweite 1 [mm]
Nutzlast bis [kg]	Nutzlast bis [kg]	Schrägheck	Schrägheck
Nutzlast-Code	Nutzlast-Code	Slowakische Republik	Slowakische Republik
Nutzlast leicht	Nutzlast leicht	Trommelbremse	Trommelbremse
Nutzlast schwer	Nutzlast schwer	TRW	Bremssystem, Lucas / TRW
ohne Bremsflüssigkeitsbehälter	ohne Bremsflüssigkeitsbehälter	Tschechische Republik	Tschechische Republik
ohne Druckregler	ohne Druckregler	Türenanzahl	Türenanzahl
ohne Drucksensor	ohne Drucksensor	Ungarn	Ungarn
ohne Steuergerät	ohne Steuergerät	x	Anschlussanzahl
Orga →	für Organisationsnummer ab	Zubehör	Zubehör
- Performance Parts	für Fahrzeuge ohne Performance Bremse	zusätzlich benötigter Artikel (Artikel-Nummer)	zusätzlich benötigter Artikel (Artikel-Nummer)
pneumatisch	pneumatisch	∅	Durchmesser [mm]
Produkttyp vorhanden	Produkttyp vorhanden	∅ "	Durchmesser [Zoll]
Radstand [mm]	Radstand [mm]	∅1	Durchmesser 1 [mm]
Republik Korea (Südkorea)	Republik Korea (Südkorea)	∅2	Durchmesser 2 [mm]
- RU	Russland	→	Baujahr ab Fahrgestellnummer (VIN) ab
SA Code ab →	SA Code ab	→	Baujahr bis Fahrgestellnummer (VIN) bis
Satz	Satz	→ Modelljahr bis	Modelljahr bis
Schaltgetriebe	Schaltgetriebe	→ Orga	für Organisationsnummer bis
		→ SA Code bis	SA Code bis

Technische Übersetzungen

Technical translations - Traducciones técnicas - Traductions techniques - Traduzioni tecniche

EN		EN	
	Brake Master Cylinder	Ausstattungs-Code	Equipment Code
	Brake Force Regulator	Automatikgetriebe	Automatic Transmission
	Brake Booster	BDX	Brake System, Bendix
	Left	Bördelform	Flange Shape
+ ABS	for vehicles with ABS	BOS	Brake System, Bosch
+ ASC	for vehicles with ASC	Bosnien-Herzegowina	Bosnia-Herzegovina
+ ASR	for vehicles with ASR	Bremskraftverstärker	Brake Booster
+ DSC	for vehicles with DSC	Brems-system	Brake System
+ DSTC	for vehicles with DSTC	CVT-Automatikgetriebe (stufenlos)	CVT automatic transmission (stepless)
+ EDS	for vehicles with EDS	DEL	Brake System, Delco
+ ESP	for vehicles with ESP	- Diff	without differential lock
+ Performance Parts	for vehicles with Performance brakes	- DSC	for vehicles without DSC
+PR	for PR number	- DSTC	for vehicles without DSTC
+ RO	Romania	E	E
+SA	for SA code	empty/leer	Observe mounting information
+ TR	Turkey	Erfüllte Qualitätsstufen	Reached Quality Gates
12Q	12Q	- ESP	for vehicles without ESP
14Q	14Q	F	F
16Q	16Q	Fahrzeugproduktionsland	Vehicle Production Country
2019	2019	Felge Lochzahl	Rim Hole Number
20Q	20Q	Felgengröße [Zoll]	Rim Size [inch]
Abfrage Produktbild vorhanden		Frankreich	France
- ABS	for vehicles without ABS	für DAM-Nummer ab →	for DAM number from
Aluguss	Cast Aluminium	für Fahr-schulwagen	for driving school cars
Artikelnummer des empfohlenen Zubehörs	Article number of recommended accessories	für Fahrzeuge mit Adaptive Cruise Control	for vehicles with Adaptive Cruise Control
- ASC	for vehicles without ASC		
- ASR	for vehicles without ASR		
ausschließlich für Rennsportzwecke	Only for racing purposes		



Technische Übersetzungen

Technical translations - Traducciones tecnicas - Traductions techniques - Traduzioni tecniche

EN		EN	
für Fahrzeuge mit AMG-Sportpaket	for vehicles with AMG Sports Package	für Fahrzeuge mit Sportpaket	for vehicles with sports package
für Fahrzeuge mit autom. Distanzregelung	for vehicles with autom. distance control	für Fahrzeuge mit Start-Stopp-Funktion	for vehicles with start-stop function
für Fahrzeuge mit Bremsassistent	for vehicles with brake assist	für Fahrzeuge mit STC	for vehicles with STC
für Fahrzeuge mit elektr. Dämpferregulierung	for vehicles with electronic suspension control	für Fahrzeuge mit Trommelbremse an der Hinterachse	for vehicles with drum brakes on the rear axle
für Fahrzeuge mit elektronischer Fahrdynamikregelung	for vehicles with electronic drive dynamics control	für Fahrzeuge mit verstärktem Fahrwerk	for vehicles with heavy duty suspension
für Fahrzeuge mit Kollisionswarner	for vehicles with collision warning system	für Fahrzeuge mit verstärkter Bremse	for vehicles with reinforced brakes
für Fahrzeuge mit M-Sportbremse	for vehicles with M-sport brakes	für Fahrzeuge ohne Adaptive Cruise Control	for vehicles without Adaptive Cruise Control
für Fahrzeuge mit Rußpartikelfilter	for vehicles with soot particulate filter	für Fahrzeuge ohne Aktivlenkung	for vehicles without active steering
für Fahrzeuge mit Scheibenbremse an der Hinterachse	for vehicles with disc brakes on the rear axle	für Fahrzeuge ohne AMG-Sportpaket	for vehicles without AMG sports package
für Fahrzeuge mit Servolenkung	for vehicles with power steering	für Fahrzeuge ohne autom. Distanzregelung	for vehicles without autom. distance control
für Fahrzeuge mit Sportfahrwerk	for vehicles with sports suspension	für Fahrzeuge ohne Bremsassistent	for vehicles without brake assist
		für Fahrzeuge ohne elektronische Fahrdynamikregelung	for vehicles without electronic drive dynamics control

Technische Übersetzungen

Technical translations - Traducciones tecnicas - Traductions techniques - Traduzioni tecniche

EN		EN	
für Fahrzeuge ohne Keramikbremse	for vehicles without ceramic brakes	für verlängerten Radstand	for extended wheelbase
für Fahrzeuge ohne Kollisionswarner	for vehicles without collision warning system	Gebrauchszahl	usage number
für Fahrzeuge ohne M-Sportbremse	for vehicles without M-sport brakes	Getriebeautomatik 6 Gang	6-Speed Automatic Transmission
für Fahrzeuge ohne Servolenkung	for vehicles without power steering	Gewindemaß 1	Thread Size 1
für Fahrzeuge ohne Sportfahrwerk	for vehicles without sports suspension	Gewindemaß 2	Thread Size 2
für Fahrzeuge ohne Sportpaket	for vehicles without sports package	GG	Cast iron brake caliper
für Fahrzeuge ohne Start-Stopp-Funktion	for vehicles without start-stop function	Herstellereinschränkung	Manufacturer Restriction
für Fahrzeuge ohne STC	for vehicles without STC	hyd.	Hydraulic
für Fahrzeuge ohne verstärktes Fahrwerk	for vehicles without heavy duty suspension	Kroatien	Croatia
für Kolben-Ø [mm]	for piston Ø [mm]	L=	Length [mm]
für Linkslenker	for left-hand drive vehicles	L=	Overall Length [mm]
für Modellreihenbaumuster	for model code	L1=	Length 1 [mm]
für OE-Nummer	for OE number	L2=	Length 2 [mm]
für Rechtslenker	for right-hand drive vehicles	Länderspezifische Verpackungs- und Status-Informationen	Country specific package and status data
für verkürzten Radstand	for shortened wheelbase	lastabhängig	Load-dependent
		mit Bremsflüssigkeitsbehälter	with brake fluid reservoir
		mm Radnabendurchmesser [mm]	Wheel Hub Diameter [mm]
		Motorcode	Engine Code
		Nicht erfüllte Qualitätsstufen	Unreached Quality Gates
		nicht für Facelift	not for facelift
		nicht für Fahrschulwagen	not for driving school cars
		nicht für Fahrzeuge mit verstärkter Bremse	not for vehicles with reinforced brakes







Technische Übersetzungen

Technical translations - Traducciones tecnicas - Traductions techniques - Traduzioni tecniche

EN		EN	
nicht für gepanzerte Fahrzeuge	not for armoured vehicles	Schaltgetriebe, automatisch betätigt	Manual Transmission, automatically operated
nicht für Sonderfahrzeuge	not for special-purpose vehicles	Schaltgetriebe 6 Gang	6-Speed Manual Transmission
Nutzlast [kg]	Payload [kg]	Scheibenbremse	Disc Brake
Nutzlast ab [kg]	Payload from [kg]	Schlüsselweite 1 [mm]	Spanner size 1 [mm]
Nutzlast bis [kg]	Payload to [kg]	Schrägheck	Hatchback
Nutzlast-Code	Payload code	Slowakische Republik	Slovakia
Nutzlast leicht	Payload light	Trommelbremse	Drum Brake
Nutzlast schwer	Payload heavy	TRW	Brake System, Lucas / TRW
ohne Bremsflüssigkeitsbehälter	without brake fluid reservoir	Tschechische Republik	Czech Republic
ohne Druckregler	without pressure regulator	Türenanzahl	Number of Doors
ohne Drucksensor	without pressure sensor	Ungarn	Hungary
ohne Steuergerät	without control unit	x	Number of connectors
Orga →	for RPO number from	Zubehör	Accessories
- Performance Parts	for vehicles without Performance brakes	zusätzlich benötigter Artikel (Artikel-Nummer)	Additionally required articles (article numbers)
pneumatisch	Pneumatic	∅	Diameter [mm]
Produkttyp vorhanden		∅ "	Diameter [inch]
Radstand [mm]	Wheelbase [mm]	∅1	Diameter 1 [mm]
Republik Korea (Südkorea)	Republic of Korea (South Korea)	∅2	Diameter 2 [mm]
- RU	Russia	→	Construction Year from Vehicle Identification Number (VIN) from
SA Code ab →	SA code from	→	Construction Year to Vehicle Identification Number (VIN) to
Satz	Set	→ Modelljahr bis	Model Year to
Schaltgetriebe	Manual Transmission	→ Orga	for RPO number up to
		→ SA Code bis	SA code to

Technische Übersetzungen

Technical translations - Traducciones técnicas - Traductions techniques - Traduzioni tecniche

ES		ES	
	Cilindro principal de freno	Ausstattungs-Code	Código de equipamiento
	Regulador de la fuerza de frenado	Automatikgetriebe	Transmisión automática
	Servofrenos	BDX	Sistema de frenos, Bendix
	izquierda	Bördelform	Tipo rebordeado
+ ABS	para vehículos con ABS	BOS	Sistema de frenos, Bosch
+ ASC	para vehículos con ASC	Bosnien-Herzegowina	Bosnia y Herzegovina
+ ASR	para vehículos con ASR	Bremskraftverstärker	Servofrenos
+ DSC	para vehículos con DSC	Brems-system	Sistema de frenos
+ DSTC	para vehículos con DSTC	CVT-Automatikgetriebe (stufenlos)	Transmisión automática CVT (continua)
+ EDS	para vehículos con EDS	DEL	Sistema de frenos, Delco
+ ESP	para vehículos con ESP	- Diff	sin bloqueo de diferencial
+ Performance Parts	para vehículos con frenos alto rendimiento	- DSC	para vehículos sin DSC
+PR	Número de PR	- DSTC	Para vehículos sin DSCT
+ RO	Rumania	E	E
+SA	para código SA	empty/leer	Observar información de montaje
+ TR	Turquía	Erfüllte Qualitätsstufen	Reached Quality Gates
12Q	12Q	- ESP	para vehículos sin ESP
14Q	14Q	F	F
16Q	16Q	Fahrzeugproduktionsland	País producción vehículo
2019	2019	Felge Lochzahl	Llanta, nº de taladros
20Q	20Q	Felgengröße [Zoll]	Tamaño de llanta [in]
Abfrage Produktbild vorhanden		Frankreich	Francia
- ABS	para vehículos sin ABS	für DAM-Nummer ab →	para número DAM desde
Aluguss	Fundición de aluminio	für Fahr-schulwagen	para coche de autoescuela
Artikelnummer des empfohlenen Zubehörs	Nº art. de accesorio recomendado	für Fahr-zeuge mit Adaptive Cruise Control	para vehículos con Adaptive Cruise Control
- ASC	para vehículos sin ASC		
- ASR	para vehículos sin ASR		
ausschließlich für Rennsportzwecke	sólo para competiciones deportivas		



Technische Übersetzungen

Technical translations - Traducciones técnicas - Traductions techniques - Traduzioni tecniche

ES		ES	
für Fahrzeuge mit AMG-Sportpaket	para vehículos con paquete sport AMG	für Fahrzeuge mit Sportpaket	para vehículos con paquete sport
für Fahrzeuge mit autom. Distanzregelung	para vehículos con regulación automática de distancia	für Fahrzeuge mit Start-Stopp-Funktion	para vehículos con sistema Start&Stop
für Fahrzeuge mit Bremsassistent	para vehículos con asistencia a la frenada	für Fahrzeuge mit STC	para vehículos con STC
für Fahrzeuge mit elektr. Dämpferregulierung	para vehículos con regulación eléctrica de amortiguación	für Fahrzeuge mit Trommelbremse an der Hinterachse	para vehículos con freno de tambor en eje trasero
für Fahrzeuge mit elektronischer Fahrdynamikregelung	para vehículos con regulación dinámica de conducción	für Fahrzeuge mit verstärktem Fahrwerk	para vehículos con chasis reforzado
für Fahrzeuge mit Kollisionswarner	para vehículos con aviso de colisión	für Fahrzeuge mit verstärkter Bremse	para vehículos con freno reforzado
für Fahrzeuge mit M-Sportbremse	Para vehículos con frenos deportivos M	für Fahrzeuge ohne Adaptive Cruise Control	para vehículos sin Adaptive Cruise Control
für Fahrzeuge mit Rußpartikelfilter	para vehículos con filtro de partículas	für Fahrzeuge ohne Aktivlenkung	para vehículos sin dirección activo
für Fahrzeuge mit Scheibenbremse an der Hinterachse	para vehículos con freno de disco en eje trasero	für Fahrzeuge ohne AMG-Sportpaket	para vehículos sin paquete deportivo AMG
für Fahrzeuge mit Servolenkung	para vehículos con dirección asistida	für Fahrzeuge ohne autom. Distanzregelung	para vehículos sin regulación automática de distancia
für Fahrzeuge mit Sportfahrwerk	para vehículos con chasis deportivo	für Fahrzeuge ohne Bremsassistent	Para vehículos sin asistencia a la frenada
		für Fahrzeuge ohne elektronische Fahrdynamikregelung	para vehículos sin control dinámico de conducción

Technische Übersetzungen

Technical translations - Traducciones técnicas - Traduccions techniques - Traduzioni tecniche

ES		ES	
für Fahrzeuge ohne Keramikbremse	para vehículos sin frenos de cerámica	für verlängerten Radstand	para distancia entre ejesprolongada
für Fahrzeuge ohne Kollisionswarner	para vehículos sin aviso de colisión	Gebrauchsnummer	Número de uso
für Fahrzeuge ohne M-Sportbremse	Para vehículos sin frenos deportivos M	Getriebeautomatik 6 Gang	Automático, 6 vel.
für Fahrzeuge ohne Servolenkung	para vehículos sin dirección asistida	Gewindemaß 1	Rosca 1
für Fahrzeuge ohne Sportfahrwerk	para vehículos sin chasis deportivo	Gewindemaß 2	Rosca 2
für Fahrzeuge ohne Sportpaket	para vehículos sin paquete sport	GG	Pinza de frenos de hierro fundido
für Fahrzeuge ohne Start-Stopp-Funktion	para vehículos sin sistema Start&Stop	Herstellereinschränkung	Restricción de fabricante
für Fahrzeuge ohne STC	para vehículos sin STC	hyd.	hidráulico
für Fahrzeuge ohne verstärktes Fahrwerk	para vehículos sin chasis reforzado	Kroatien	Croacia
für Kolben-Ø [mm]	para pistón - Ø [mm]	L=	Longitud [mm]
für Linkslenker	para vehic. dirección izquierda	L=	Longitud total [mm]
für Modellreihenbaumuster	para el tipo de serie del modelo	L1=	Longitud 1 [mm]
für OE-Nummer	para OE N°	L2=	Longitud 2 [mm]
für Rechtslenker	para vehíc. dirección a la derecha	Länderspezifische Verpackungs- und Status-Informationen	Información específica del país sobre el embalaje y sobre el estado
für verkürzten Radstand	para distancia entre ejes acortada	lastabhängig	dependiente de la carga
		mit Bremsflüssigkeitsbehälter	con depósito líquido frenos
		mm Radnabendurchmesser [mm]	Diám. buje de rueda [mm]
		Motorcode	Código de motor
		Nicht erfüllte Qualitätsstufen	Unreached Quality Gates
		nicht für Facelift	no para facelift
		nicht für Fahrschulwagen	no para veh. autoescuela
		nicht für Fahrzeuge mit verstärkter Bremse	no para vehículos con frenos reforzados







Technische Übersetzungen

Technical translations - Traducciones técnicas - Traductions techniques - Traduzioni tecniche

ES		ES	
nicht für gepanzerte Fahrzeuge	no para vehículos blindados	Schaltgetriebe, automatisch betätigt	Caja de cambios manual, accionamiento automático
nicht für Sonderfahrzeuge	no para veh. especiales	Schaltgetriebe 6 Gang	Caja de cambios manual, 6 marchas
Nutzlast [kg]	Carga útil [kg]	Scheibenbremse	Discos
Nutzlast ab [kg]	carga útil desde [kg]	Schlüsselweite 1 [mm]	Ancho de llave 1 [mm]
Nutzlast bis [kg]	carga útil hasta [kg]	Schrägheck	Fastback
Nutzlast-Code	Código de carga útil	Slowakische Republik	República eslovaca
Nutzlast leicht	Carga útil ligera	Trommelbremse	Tambor
Nutzlast schwer	Carga útil pesada	TRW	Sistema de frenos, Lucas / TRW
ohne Bremsflüssigkeitsbehälter	sin depósito líquido frenos	Tschechische Republik	República Checa
ohne Druckregler	sin regulador de presión	Türenanzahl	Número de puertas
ohne Drucksensor	sin sensor de presión	Ungarn	Hungría
ohne Steuergerät	sin unidad de control	x	Número de conexiones
Orga →	para número de OPR desde	Zubehör	Accesorios
- Performance Parts	para vehículos sin frenos alto rendimiento	zusätzlich benötigter Artikel (Artikel-Nummer)	Se requiere adicionalmente artículo N°
pneumatisch	neumático	∅	Diámetro [mm]
Produkttyp vorhanden		∅ "	Diámetro [in]
Radstand [mm]	Distancia entre ejes [mm]	∅1	Diámetro 1 [mm]
Republik Korea (Südkorea)	Rep. Corea (Corea del Sur)	∅2	Diámetro 2 [mm]
- RU	Rusia	→	año construcción desde N.º de chasis (VIN) desde
SA Code ab →	código SA a partir de	→	año construcción hasta N.º de chasis (VIN) hasta
Satz	Kit	→ Modelljahr bis	año modelo hasta
Schaltgetriebe	Caja de cambios manual	→ Orga	para número de OPR hasta
		→ SA Code bis	código SA hasta

Technische Übersetzungen

Technical translations - Traducciones técnicas - Traductions techniques - Traduzioni tecniche

FR		FR	
	Maître-cylindre de frein	ausschließlich für Rennsportzwecke	exclusivement pour véhicules de courses
	Régulateur de freinage	Ausstattungs-Code	Code d'équipement
	Dispositif d'assistance de frein	Automatikgetriebe	Boîte automatique
	gauche	BDX	Système de freinage, Bendix
+ ABS	pour véhicules avec système antiblo-cage	Bördelform	Forme du bord relevé
+ ASC	pour véhicules avec ASC	BOS	Système de freinage, Bosch
+ ASR	pour véhicules avec ASR	Bosnien-Herzegowina	Bosnie-Herzégovine
+ DSC	pour véhicules avec DSC	Bremskraft-verstärker	Servofrein
+ DSTC	pour véhicules avec DSTC	Brems-system	Système de freinage
+ EDS	pour véhicules avec EDS	CVT-Automa-tikgetriebe (stufenlos)	Boîte de vitesses automatique CVT (continue)
+ ESP	pour véhicules avec ESP	DEL	Système de freinage, Delco
+ Performance Parts	pour véhicule avec frein Performance	- Diff	sans blocage de différentiel
+PR	pour numéro PR	- DSC	pour véhicules sans DSC
+ RO	Roumanie	- DSTC	pour véhicules sans DSTC
+SA	pour SA code	E	E
+ TR	Turquie	empty/leer	Attention au infos de montage!
12Q	12Q	Erfüllte Qualitäts-stufen	Reached Quality Gates
14Q	14Q	- ESP	pour véhicules sans ESP
16Q	16Q	F	F
2019	2019	Fahrzeugpro-duk-tionsland	Pays constructeur du véhicule
20Q	20Q	Felge Loch-zahl	Jante, nombre de trous
Abfrage Produktbild vorhanden		Felgengröße [Zoll]	Dimension de la jante [pouces]
- ABS	pour véhicules sans système antiblo-cage	Frankreich	France
Aluguss	Fonte d'aluminium	für DAM-Nummer ab →	pour numéro DAM à partir de
Artikel-nummer des empfohlenen Zubehörs	Référence de l'accessoire recommandé	für Fahr-schulwagen	pour véhicules d'auto-école
- ASC	pour véhicules sans ASC		
- ASR	pour véhicules sans ASR		



Technische Übersetzungen

Technical translations - Traducciones técnicas - Traductions techniques - Traduzioni tecniche

FR		FR	
für Fahrzeuge mit Adaptive Cruise Control	pour véhicule avec Adaptive Cruise Control	für Fahrzeuge mit Sportfahrwerk	pour véhicules avec châssis sportif
für Fahrzeuge mit AMG-Sportpaket	pour véhicules avec pack sport AMG	für Fahrzeuge mit Sportpaket	pour véhicules avec équipement sport
für Fahrzeuge mit autom. Distanzregelung	pour véhicules avec régulation de distance autom.	für Fahrzeuge mit Start-Stopp-Funktion	pour véhicules avec fonction Stop/Start
für Fahrzeuge mit Bremsassistent	pour véhicules avec assistant au freinage	für Fahrzeuge mit STC	pour véhicules avec STC
für Fahrzeuge mit elektr. Dämpferregulierung	pour véhicules avec réglage d'amortisseur électronique	für Fahrzeuge mit Trommelbremse an der Hinterachse	pour véhicules avec frein à tambour à l'essieu arrière
für Fahrzeuge mit elektronischer Fahrdynamikregelung	p. véhicules avec régulat° électro. de dynamique de conduite	für Fahrzeuge mit verstärktem Fahrwerk	pour véhicules avec châssis renforcé
für Fahrzeuge mit Kollisionswarner	pour véhicules avec système anti-collision	für Fahrzeuge mit verstärkter Bremse	pour véhicules avec frein assisté
für Fahrzeuge mit M-Sportbremse	pour véhicules avec système de freinage sport M	für Fahrzeuge ohne Adaptive Cruise Control	pour véhicule sans Adaptive Cruise Control
für Fahrzeuge mit Rußpartikelfilter	pour véhicules avec filtre à particules	für Fahrzeuge ohne Aktivlenkung	pour véhicules sans direction active
für Fahrzeuge mit Scheibenbremse an der Hinterachse	pour véhicules avec frein à disques à l'essieu arrière	für Fahrzeuge ohne AMG-Sportpaket	pour véhicules sans pack sport AMG
für Fahrzeuge mit Servolenkung	pour véhicules avec direction assistée	für Fahrzeuge ohne autom. Distanzregelung	pour véhicules sans régulation de distance autom.
		für Fahrzeuge ohne Bremsassistent	pour véhicules sans assistant de freinage

Technische Übersetzungen

Technical translations - Traducciones técnicas - Traductions techniques - Traduzioni tecniche

FR	FR
für Fahrzeuge ohne elektronische Fahrdynamikregelung	für verkürzten Radstand
pr véhicules sans régulation électr. dynamique de conduite	pour empattement raccourci
für Fahrzeuge ohne Keramikbremse	für verlängerten Radstand
pour véhicules sans frein en céramique	pour empattement rallongé
für Fahrzeuge ohne Kollisionswarner	Gebrauchsnummer
pour véhicules sans système anti-collision	Numéro d'utilisation
für Fahrzeuge ohne M-Sportbremse	Getriebeautomatik 6 Gang
pour véhicules sans système de freinage sport M	Boîte automatique à 6 vitesses
für Fahrzeuge ohne Servolenkung	Gewindemaß 1
pour véhicules sans direction assistée	Taraudage/Filetage 1
für Fahrzeuge ohne Sportfahrwerk	Gewindemaß 2
pour véhicules sans châssis sportif	Taraudage/Filetage 2
für Fahrzeuge ohne Sportpaket	GG
pour véhicules sans équipement sport	Étrier de frein en fonte
für Fahrzeuge ohne Start-Stopp-Funktion	Herstellereinschränkung
pour véhicules sans fonction Stop/Start	Montage d'origine
für Fahrzeuge ohne STC	hyd.
pour véhicules sans STC	hydraulique
für Fahrzeuge ohne verstärktes Fahrwerk	Kroatien
pour véhicules sans châssis renforcé	Croatie
für Kolben-Ø [mm]	L=
pour piston-Ø [mm]	Longueur [mm]
für Linkslenker	L=
pour véhicules avec direction à gauche	Longueur globale [mm]
für Modellreihenbaumuster	L1=
pour le modèle de la série de modèles	Longueur 1 [mm]
für OE-Nummer	L2=
pour numéro OE	Longueur 2 [mm]
für Rechtslenker	Länderspezifische Verpackungs- und Status-Informationen
pour véhicules avec direction à droite	Informations d'emballage et d'état spécifiques aux pays
	lastabhängig
	Fonction de la charge
	mit Bremsflüssigkeitsbehälter
	avec filtre déshydratant pour liquide de freins
	mm Radnabendurchmesser [mm]
	Diamètre moyeu de roue [mm]
	Motorcode
	Code moteur
	Nicht erfüllte Qualitätsstufen
	Unreached Quality Gates
	nicht für Facelift
	pas pour facelift
	nicht für Fahrschulwagen
	pas pour véhicules d'auto-école







Technische Übersetzungen

Technical translations - Traducciones técnicas - Traductions techniques - Traduzioni tecniche

FR		FR	
nicht für Fahrzeuge mit verstärkter Bremse	pas pour véhicules avec frein assisté	Satz	Jeu
nicht für gepanzerte Fahrzeuge	pas pour véhicules blindés	Schaltgetriebe	boîte de vitesses manuelle
nicht für Sonderfahrzeuge	pas pour véhicules spéciaux	Schaltgetriebe, automatisch betätigt	Boîte de vitesses mécanique à commande automatisée
Nutzlast [kg]	Charge utile [kg]	Schaltgetriebe 6 Gang	Boîte de vitesses manuelle à 6 vitesses
Nutzlast ab [kg]	Charge utile à partir de [kg]	Scheibenbremse	Frein à disque
Nutzlast bis [kg]	Charge utile jusqu'à [kg]	Schlüsselweite 1 [mm]	Largeur de clé 1 [mm]
Nutzlast-Code	Code de charge utile	Schrägheck	3/5 portes
Nutzlast leicht	Charge utile légère	Slowakische Republik	République slovaque
Nutzlast schwer	Charge utile lourde	Trommelbremse	Frein à tambour
ohne Bremsflüssigkeitsbehälter	sans réservoir du liquide de frein	TRW	Système de freinage, Lucas / TRW
ohne Druckregler	sans régulateur de pression	Tschechische Republik	République tchèque
ohne Drucksensor	sans capteur de pression	Türenanzahl	Nombre de portes
ohne Steuergerät	sans appareil de commande	Ungarn	Hongrie
Orga →	pour n° OPR(date de fabrication du véhicule) à partir de	x	Nombre de connexions
- Performance Parts	pour véhicules sans frein Performance	Zubehör	Accessoires
pneumatisch	pneumatique	zusätzlich benötigter Artikel (Artikel-Nummer)	article supplémentaire (référence)
Produkttyp vorhanden		∅	Diamètre [mm]
Radstand [mm]	Empattement [mm]	∅ "	Diamètre [pouces]
Republik Korea (Südkorea)	République de Corée (Corée du Sud)	∅1	Diamètre 1 [mm]
- RU	Russie	∅2	Diamètre 2[mm]
SA Code ab →	Code SA à partir de	→	Année à partir de Numéro de châssis (VIN) à partir de
		→	Année jusqu'à Numéro de châssis (VIN) à
		→ Modelljahr bis	Année jusqu'à
		→ Orga	pour numéro OPR jusqu'à
		→ SA Code bis	Code SA jusqu'à

Technische Übersetzungen

Technical translations - Traducciones técnicas - Traductions techniques - Traduzioni tecniche

IT		IT	
	Cilindro maestro del freno	Ausstattungs-Code	Codice dotazione
	Modulatore frenata	Automatikgetriebe	Trasmissione automatica
	Servofreno	BDX	Sistema frenante, Bendix
	Sx	Bördelform	Forma bordatura
+ ABS	per veicoli con ABS	BOS	Sistema frenante, Bosch
+ ASC	per veicoli con ASC	Bosnien-Herzegowina	Bosnia ed Erzegovina
+ ASR	per veicoli con ASR	Bremskraftverstärker	Servofreno
+ DSC	per veicoli con DSC	Brems-system	Sistema frenante
+ DSTC	per veicoli con DSTC	CVT-Automatikgetriebe (stufenlos)	Cambio automatico CVT (continuo)
+ EDS	per veicoli con EDS	DEL	Sistema frenante, Delco
+ ESP	per veicoli con ESP	- Diff	senza blocco differenziale
+ Performance Parts	per veicoli con freno Performance	- DSC	per veicoli senza DSC
+PR	per N° PR	- DSTC	per veicoli senza DSTC
+ RO	Romania	E	E
+SA	per codice SA	empty/leer	Osservare info montaggio
+ TR	Turchia	Erfüllte Qualitätsstufen	Reached Quality Gates
12Q	12Q	- ESP	per veicoli senza ESP
14Q	14Q	F	F
16Q	16Q	Fahrzeugproduktionsland	Paese produzione veicolo
2019	2019	Felge Lochzahl	Cerchione, N° fori
20Q	20Q	Felgengröße [Zoll]	Misura cerchione [pollici]
Abfrage Produktbild vorhanden		Frankreich	Francia
- ABS	per veicoli senza ABS	für DAM-Nummer ab →	per numero DAM da
Aluguss	Alluminio pressofuso	für Fahr-schulwagen	per vettura per scuola guida
Artikelnummer des empfohlenen Zubehörs	N° articolo accessorio consigliato	für Fahr-zeuge mit Adaptive Cruise Control	per veicoli con Adaptive Cruise Control
- ASC	per veicoli senza ASC		
- ASR	per veicoli senza ASR		
ausschließlich für Rennsportzwecke	solo per uso agonistico		



Technische Übersetzungen

Technical translations - Traducciones técnicas - Traductions techniques - Traduzioni tecniche

IT		IT	
für Fahrzeuge mit AMG-Sportpaket	per veicoli con pacchetto sportivo AMG	für Fahrzeuge mit Sportpaket	per veicoli con pacchetto sportivo
für Fahrzeuge mit autom. Distanzregelung	per veicoli con regolatore automatico distanza	für Fahrzeuge mit Start-Stopp-Funktion	per veicoli con funzione di start-stop
für Fahrzeuge mit Bremsassistent	per veicoli con brake assist	für Fahrzeuge mit STC	per veicoli con STC
für Fahrzeuge mit elektr. Dämpferregulierung	per veicoli con regolazione elettr. ammortizzatori	für Fahrzeuge mit Trommelbremse an der Hinterachse	per veicoli con freni a tamburo ad assale posteriore
für Fahrzeuge mit elektronischer Fahrdynamikregelung	per veicoli con regolazione elettronica dinamica di guida	für Fahrzeuge mit verstärktem Fahrwerk	per veicoli con autotelaio rinforzato
für Fahrzeuge mit Kollisionswarner	per veicoli con segnale anticollisione	für Fahrzeuge mit verstärkter Bremse	per veicoli con freno rinforzato
für Fahrzeuge mit M-Sportbremse	per veicoli con freni sportivi M	für Fahrzeuge ohne Adaptive Cruise Control	per veicoli senza Adaptive Cruise Control
für Fahrzeuge mit Rußpartikelfilter	per veicoli con filtro antiparticolato	für Fahrzeuge ohne Aktivlenkung	per veicoli senza meccanismo sterzo attivo
für Fahrzeuge mit Scheibenbremse an der Hinterachse	per veicoli con freni a disco ad assale posteriore	für Fahrzeuge ohne AMG-Sportpaket	per veicoli senza pacchetto sportivo AMG
für Fahrzeuge mit Servolenkung	per veicoli con servosterzo	für Fahrzeuge ohne autom. Distanzregelung	per veicoli senza regolatore automatico distanza
für Fahrzeuge mit Sportfahrwerk	per veicoli con autotelaio sportivo	für Fahrzeuge ohne Bremsassistent	per veicoli senza brake assist
		für Fahrzeuge ohne elektronische Fahrdynamikregelung	per veicoli senza regolazione elettronica dinamica guida

Technische Übersetzungen

Technical translations - Traducciones técnicas - Traductions techniques - Traduzioni tecniche

IT		IT	
für Fahrzeuge ohne Keramikbremse	per veicoli senza freni in ceramica	für verlängerten Radstand	per passo route allungato
für Fahrzeuge ohne Kollisionswarner	per veicoli senza segnale anticollisione	Gebrauchsnummer	Codice d'uso
für Fahrzeuge ohne M-Sportbremse	per veicoli senza freni sportivi M	Getriebeautomatik 6 Gang	Cambio automatico a 6 marce
für Fahrzeuge ohne Servolenkung	per veicoli senza servosterzo	Gewindemaß 1	Dimensioni filettatura 1
für Fahrzeuge ohne Sportfahrwerk	per veicoli senza autotelaio sportivo	Gewindemaß 2	Dimensioni filettatura 2
für Fahrzeuge ohne Sportpaket	per veicoli senza pacchetto sportivo	GG	Pinza freno in ghisa
für Fahrzeuge ohne Start-Stopp-Funktion	per veicoli senza funzione di start-stop	Herstellereinschränkung	Limitazione costruttore
für Fahrzeuge ohne STC	per veicoli senza STC	hyd.	idraulico
für Fahrzeuge ohne verstärktes Fahrwerk	per veicoli senza autotelaio rinforzato	Kroatien	Croazia
für Kolben-Ø [mm]	per pistone-Ø [mm]	L=	Lunghezza [mm]
für Linkslenker	per veicolo con guida a Sx	L=	Lunghezza totale [mm]
für Modellreihenbaumuster	per la serie di modelli	L1=	Lunghezza 1 [mm]
für OE-Nummer	per N° OE	L2=	Lunghezza 2 [mm]
für Rechtslenker	per veicolo con guida a Dx	Länderspezifische Verpackungs- und Status-Informationen	Informazioni di imballaggio e di stato specifiche per i diversi Paesi
für verkürzten Radstand	per passo route accorciato	lastabhängig	subordinato al carico
		mit Bremsflüssigkeitsbehälter	con serbatoio liquido freni
		mm Radnabendurchmesser [mm]	Diametro mozzo ruota [mm]
		Motorcode	Codice motore
		Nicht erfüllte Qualitätsstufen	Unreached Quality Gates
		nicht für Facelift	non per Facelift
		nicht für Fahrschulwagen	Non per vettura per scuola guida
		nicht für Fahrzeuge mit verstärkter Bremse	Non per veicoli con freno rinforzato



Technische Übersetzungen

Technical translations - Traducciones tecnicas - Traductions techniques - Traduzioni tecniche

IT		IT	
nicht für gepanzerte Fahrzeuge	Non per veicoli corazzati	Schaltgetriebe, automatisch betätigt	Cambio manuale, azionamento automatico
nicht für Sonderfahrzeuge	Non per veicoli speciali	Schaltgetriebe 6 Gang	Cambio manuale a 6 marce
Nutzlast [kg]	Portatautile [kg]	Scheibenbremse	Freno a disco
Nutzlast ab [kg]	Portata utile da [kg]	Schlüsselweite 1 [mm]	Apertura chiave 1 [mm]
Nutzlast bis [kg]	Portata utile fino a [kg]	Schrägheck	2 volumi /Coda spiovente
Nutzlast-Code	Codice portata utile	Slowakische Republik	Repubblica slovacca
Nutzlast leicht	Portata utile leggera	Trommelbremse	Freno a tamburo
Nutzlast schwer	Portata utile pesante	TRW	Sistema frenante, Lucas / TRW
ohne Bremsflüssigkeitsbehälter	senza serbatoio liquido freni	Tschechische Republik	Repubblica ceca
ohne Druckregler	senza regolatore pressione	Türenanzahl	N° portiere
ohne Drucksensor	senza sensore pressione	Ungarn	Ungheria
ohne Steuergerät	senza centralina	x	N° raccordi
Orga →	per numero organizzazione da	Zubehör	Accessori
- Performance Parts	per veicoli senza freno Performance	zusätzlich benötigter Artikel (Artikel-Nummer)	Articolo supplementare occorrente (N° articolo)
pneumatisch	pneumatico	∅	Diametro [mm]
Produkttyp vorhanden		∅ "	Diametro [pollici]
Radstand [mm]	Passo ruote [mm]	∅1	Diametro 1 [mm]
Republik Korea (Südkorea)	Repubblica di Corea(Corea del Sud)	∅2	Diametro 2 [mm]
- RU	Russia	→	Anno da N° telaio (VIN) da
SA Code ab →	Codice SA da	→	Anno fino a N° telaio (VIN) fino a
Satz	Serie / Kit	→ Modelljahr bis	Anno modello fino a
Schaltgetriebe	Cambio manuale	→ Orga	per numero organizzazione fino a
		→ SA Code bis	Codice SA fino a

ATE – A Trademark of the
Continental Corporation

**Continental Aftermarket &
Services GmbH**

Sodener Straße 9
D-65824 Schwalbach
Tel. +49 (0) 6196 87 0
Fax +49 (0) 6196 865 71

www.ate.de

**Continental Automotive Trading
Italia S.r.l.**

Via Matteotti, 62
I-20092 Cinisello Balsamo (MI)
Tel. +39 02 35680 1
Fax +39 02 35680 325
E-Mail: supporto@continental-corporation.com

www.ate-freni.it

**Continental Automotive Trading
France**

6 rue Jean Moulin
F-78120 Rambouillet

www.ate-freinage.fr

Continental Automotive Spain, S.A.

C/ Sepúlveda, 11
E-28108 Alcobendas (Madrid)
Phone +34 91 657 21 21

www.frenos-ate.es