

ATE New Parts ATE Neuteile

11/2023



Brakethrough Technology

EN Table of contents

Index of vehicles
Product details
Applications of vehicles
Technical translations

DE Inhaltsverzeichnis

3	Herstellerverzeichnis
5	Produktdetails
9	Fahrzeugverwendungen
26	Technische Übersetzungen

ES Índice

3	Índice de vehículos	3
5	Descripción del producto	5
9	Aplicaciones	9
26	Traducciones técnicas	26

FR Table des matières

Liste des véhicules
Présentation du produit
Applications
Traductions techniques

IT Sommario

3	Indice autovetture	3
5	Panoramica prodotti	5
9	Applicazioni autoveicoli	9
26	Traduzioni tecniche	26





- EN** Index of vehicles
- DE** Herstellerverzeichnis
- ES** Índice de vehículos
- FR** Liste des véhicules
- IT** Indice autovettura

**CHEVROLET 10**

AVEO Hatchback (T300)	10
AVEO Saloon (T300)	10
TRAX	10

FIAT 10

SEDICI (189_)	10
---------------	----

FORD 10

FIESTA Saloon	11
FIESTA VI (CB1, CCN)	10
FIESTA VI Van	10

HONDA 11

ACCORD IV Aerodeck (CB, CC)	11
ACCORD IV Coupe (CB, CC)	11
ACCORD IV Sedan (CB)	11
ACCORD V Aerodeck (CE)	11
ACCORD V Coupe (CD)	11
ACCORD VI Coupe (CG)	11
ACCORD VI Sedan (CE, CF_, CD)	11
ACCORD VI Sedan (CK, CG, CH, CF)	12
ACCORD V Sedan (CC, CD)	11
CIVIC IX Saloon (FB)	13
CIVIC VI Aerodeck (MB, MC)	12
CIVIC VI Fastback (MA, MB)	12
CIVIC VI Hatchback (EJ, EK)	12
CIVIC VII Coupe (EM2)	12
CIVIC VII Hatchback (EU, EP, EV)	12
CIVIC VIII Saloon (FD, FA)	12
CIVIC VII Saloon (ES, ET)	12
CIVIC VI Saloon (EJ, EK, SO)	12
INSIGHT (ZE_)	13
INTEGRA Coupe (DC2, DC4)	13
INTEGRA Coupe (DC5)	13
JAZZ III (GE_, GG_, GP_, ZA_)	13
PRELUDE IV (BB_)	13
PRELUDE V (BB_)	13
S2000 (AP)	13

HYUNDAI 13

ACCENT V Saloon (HC)	13
BAYON (BC3)	13
i20 ACTIVE (IB, GB)	14
i20 II (GB, IB)	14
i20 II Coupe (GB)	14
i20 II Hatchback Van (GB, IB)	14
i20 III (BC3, BI3)	14
ix35 (LM, EL, ELH)	14
SOLARIS Saloon (HCR)	14
TUCSON (TL, TLE)	14
TUCSON SUV Van (TLE)	15

KIA 15

RIO IV (YB, SC, FB)	15
RIO IV Hatchback Van (YB, SC, FB)	15
RIO IV Saloon (SC, FB)	15
SPORTAGE IV (QL, QLE)	15
SPORTAGE IV VAN (QL, QLE)	16

MERCEDES-BENZ 16

E-CLASS Convertible (A207)	16
E-CLASS Coupe (C207)	16
eSPRINTER Van (B910)	16
SPRINTER 3,5-t Bus (B906)	16
SPRINTER 3,5-t Platform/Chassis (B906)	17
SPRINTER 3,5-t Platform/Chassis (B907, B910)	17
SPRINTER 3,5-t Tourer Bus (B907)	17
SPRINTER 3,5-t Van (B906)	17
SPRINTER 3,5-t Van (B907, B910)	18
SPRINTER 3-t Bus (B906)	18
SPRINTER 3-t Platform/Chassis (B906)	18

**MERCEDES-BENZ 16**

SPRINTER 3-t Platform/Chassis (B910, B907)	18
SPRINTER 3-t Tourer Bus (B907)	18
SPRINTER 3-t Van (B906)	18
SPRINTER 3-t Van (B910)	19
SPRINTER 4,6-t Platform/Chassis (B906)	19
SPRINTER 4,6-t Van (B906)	19
SPRINTER 4-t Platform/Chassis (B907, B910)	19
SPRINTER 4-t Tourer Bus (B907)	19
SPRINTER 4-t Van (B907, B910)	19
SPRINTER 5-t Bus (B906)	20
SPRINTER 5-t Platform/Chassis (B906)	20
SPRINTER 5-t Platform/Chassis (B907)	20
SPRINTER 5-t Van (B906)	20
SPRINTER 5-t Van (B907)	20

MG 20

EXPRESS Hatchback Van	20
MG ZR	21

OPEL 21

MOKKA / MOKKA X (J13)	21
MOKKA X VAN (J13)	21

PORSCHE 21

911 (991)	21
911 Convertible (991)	21
911 Targa (991)	21

RENAULT 21

MODUS / GRAND MODUS (F/JP0_)	21
------------------------------	----

ROVER 21

600 I (RH)	21
------------	----

SEAT 22

LEON (5F1)	22
LEON Hatchback Van (5F1)	22
LEON SC (5F5)	22
LEON ST (5F8)	22
LEON ST Estate Van (5F8)	22

SKODA 23

OCTAVIA III (5E3, NL3, NR3)	23
OCTAVIA III Combi (5E5, 5E6)	23

SUZUKI 23

KIZASHI (FR)	23
SWIFT III (MZ, EZ)	23
SX4 (EY, GY)	24
SX4 Saloon (GY, RW)	24

VAUXHALL 24

MOKKA / MOKKA X (J13)	24
-----------------------	----

VW 24

CRAFTER 30-35 Bus (2E_)	24
CRAFTER 30-50 Platform/Chassis (2F_)	24
CRAFTER 30-50 Van (2E_)	24
CRAFTER Bus (SYI, SYJ)	24
CRAFTER Platform/Chassis (SZ_)	25
CRAFTER Van (SY_, SX_)	25
GOLF ALLTRACK VIII (CG5)	25
GOLF VIII (CD1)	25
GOLF VIII Variant (CG5)	25
GRAND CALIFORNIA Camper (SCB, SCC)	25





- EN** Product details
- DE** Produktdetails
- ES** Descripción del producto
- FR** Présentation du produit
- IT** Panoramica prodotti

13.0460-3895.2

603895

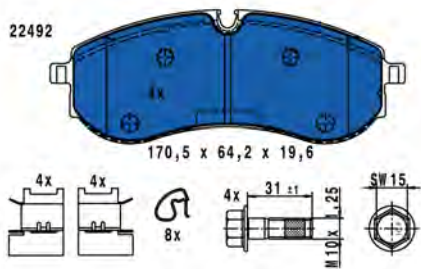

Brake Pad Set, disc brake

Thickness [mm] 19.6

Width [mm] 170.5

Height [mm] 64.2

CBI

+ WE / - WK

+ Zub

with brake caliper screws

Article number of recommended accessories: 24.8190-0994.2

VW

13.0460-4712.2

604712

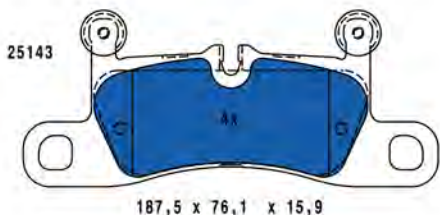

Brake Pad Set, disc brake

+ WE / - WK

Thickness [mm] 15.9

Width [mm] 187.5

Height [mm] 76.1

BRE

PORSCHE

13.0460-5557.2

605557

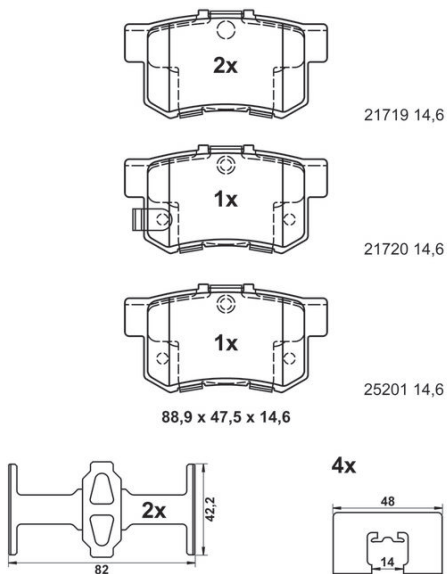

Brake Pad Set, disc brake

Thickness [mm] 14.6

Width [mm] 88.9

Height [mm] 47.5

AKE

+ WK

+ Zub

FIAT, HONDA, MG, ROVER, SUZUKI

13.0470-2654.2

LD2654

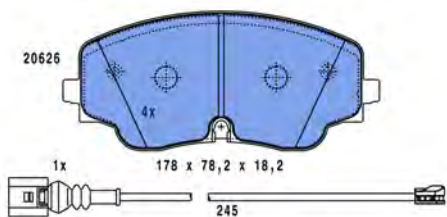

Brake Pad Set, disc brake

Thickness [mm] 18.2

Width [mm] 178

Height [mm] 78.2

TRW

+ WK

L= 245

VW



24.0710-2140.3

360677



Wheel Speed Sensor

L= 705

MERCEDES-BENZ

24.1294-0022.3

331699



Brake Hose

Spanner Size: 11

External Thread 1 [mm]: M10x1

External Thread 2 [mm]: M10x1

with pipe

L= 195

RENAULT

24.2126-1708.3

011128



Brake Master Cylinder

Ø 27

M12x1

2x

Cast Aluminium

without brake fluid reservoir

L1= 51

L2= 141.2

MERCEDES-BENZ, VW

24.3344-1745.5

241567



Brake Caliper

Service exchange part

+ FSB

without holder

TRW

Piston Diameter [mm]: 34

FORD

24.3344-1746.5

241568



Brake Caliper

Service exchange part

+ FSB

without holder

TRW

Piston Diameter [mm]: 34

FORD

24.3417-1722.5

241572



Brake Caliper

TRW

Piston Diameter [mm]: 41

Brake Caliper Colour: Red

Service exchange part

without holder

SEAT, SKODA

24.4123-1738.3

011124



Brake Master Cylinder

Ø 23.8

M12x1

2x

Cast Aluminium

without brake fluid reservoir

L1= 22

L2= 86.6

CHEVROLET, OPEL, VAUXHALL

24.5296-0390.3

331707



Brake Hose

Flange Hole Diameter [mm]: 10

L= 420

without banjo bolt

HYUNDAI, KIA















EN Applications of vehicles

















DE Fahrzeugverwendungen

















ES Aplicaciones



















FR Applications















IT Applicazioni autoveicoli













	kw					! #		
CHEVROLET - AVEO Hatchback (T300) 03/11→								
 Brake Master Cylinder								
1.2	51 - 63	03/11→		04/12→; Rim Size [inch]: 15; for left-hand drive vehicles; + ESP		24.4123-1738.3	011124	Ø 23.8 without brake fluid reservoir
1.3 D	55 - 70	07/11→12/15		→ 03/12; Rim Size [inch]: 15; for left-hand drive vehicles; - ESP		24.4123-1738.3	011124	Ø 23.8 without brake fluid reservoir
1.4	74	03/11→						
1.6	85	03/11→						
1.2 LPG	63	11/12→12/15		Rim Size [inch]: 15; for left-hand drive vehicles; + ESP		24.4123-1738.3	011124	Ø 23.8 without brake fluid reservoir
CHEVROLET - AVEO Saloon (T300) 03/11→								
 Brake Master Cylinder								
1.2	51 - 63	03/11→		04/12→; Rim Size [inch]: 15; for left-hand drive vehicles; + ESP		24.4123-1738.3	011124	Ø 23.8 without brake fluid reservoir
1.3 D	55 - 70	07/11→12/15		→ 03/12; Rim Size [inch]: 15; for left-hand drive vehicles; - ESP		24.4123-1738.3	011124	Ø 23.8 without brake fluid reservoir
1.4	74 - 103	07/11→						
1.6	85	03/11→						
1.2 LPG	63	11/12→12/15		Rim Size [inch]: 15; for left-hand drive vehicles; + ESP		24.4123-1738.3	011124	Ø 23.8 without brake fluid reservoir
CHEVROLET - TRAX 12/12→								
 Brake Master Cylinder								
1.4	103	12/12→		for left-hand drive vehicles		24.4123-1738.3	011124	Ø 23.8 without brake fluid reservoir
1.4 AWD	103	12/12→						
1.4 LPG	103	04/13→						
1.6	85	12/12→						
1.6 D	100	11/14→12/15						
1.6 D AWD	100	11/14→12/15						
1.7 TD	96	12/12→						
1.7 TD AWD	96	12/12→						
1.8	103	03/13→						
1.8 AWD	103	03/13→						
FIAT - SEDICI (189_) 06/06→10/14								
 Brake Pad Set, disc brake								
1.6 16V	79 - 88	06/06→10/14	➔			13.0460-5557.2	605557	AKE + WK + Zub
1.6 16V 4x4	79 - 88	06/06→10/14						
1.9 D Multijet	88	06/06→10/11						
1.9 D Multijet 4x4	88	06/06→10/11						
2.0 D Multijet	99	06/06→10/14						
2.0 D Multijet 4x4	99	06/06→10/14						
FORD - FIESTA VI (CB1, CCN) 06/08→								
 Brake Caliper								
1.0	48 - 59	10/12→04/17	➔	<input type="checkbox"/>		24.3344-1745.5	241567	TRW without holder + FSB
1.0 EcoBoost	74 - 92	09/12→	➔	<input type="checkbox"/>		24.3344-1746.5	241568	TRW without holder + FSB
1.0 Sport	103	05/14→04/17						
1.4	71	10/08→09/12						
1.4 LPG	68 - 71	01/09→04/17						
1.4 TDCi	50 - 51	08/08→09/12						
1.5 TDCi	55 - 70	09/12→04/17						
1.6	62 - 90	10/10→						
1.6 TDCi	55 - 70	06/08→12/15						
1.6 Ti	77 - 99	06/08→						
1.6 ST	134	03/13→04/17	➔	<input type="checkbox"/>		24.3344-1745.5	241567	TRW without holder + FSB
1.6 ST200	147	04/16→04/17	➔	<input type="checkbox"/>	Brake Caliper Colour: Red; <input type="checkbox"/>	24.3344-1745.5	241567	TRW without holder + FSB
			➔	<input type="checkbox"/>		24.3344-1746.5	241568	TRW without holder + FSB
			➔	<input type="checkbox"/>	Brake Caliper Colour: Red; <input type="checkbox"/>	24.3344-1746.5	241568	TRW without holder + FSB
FORD - FIESTA VI Van 08/08→								
 Brake Caliper								
1.4	71	10/08→12/12	➔	<input type="checkbox"/>		24.3344-1745.5	241567	TRW without holder + FSB
1.6 Ti-VCT	88	10/08→12/12	➔					













	kW			 	! #			
FORD - FIESTA VI Van 08/08→								
 Brake Caliper								
1.4	71	10/08→12/12	➡	<input type="checkbox"/>		24.3344-1746.5	241568	TRW without holder + FSB
1.6 Ti-VCT	88	10/08→12/12	➡	<input type="checkbox"/>				
1.6 ST	134	03/13→	➡	<input type="checkbox"/>		24.3344-1745.5	241567	TRW without holder + FSB
			➡	Brake Caliper Colour: Red; <input type="checkbox"/>		24.3344-1745.5	241567	TRW without holder + FSB
			➡	<input type="checkbox"/>		24.3344-1746.5	241568	TRW without holder + FSB
			➡	Brake Caliper Colour: Red; <input type="checkbox"/>		24.3344-1746.5	241568	TRW without holder + FSB
FORD - FIESTA Saloon 04/10→								
 Brake Caliper								
1.4	70	10/10→	➡	<input type="checkbox"/>		24.3344-1745.5	241567	TRW without holder + FSB
1.6	62 - 81	09/10→	➡	<input type="checkbox"/>		24.3344-1746.5	241568	TRW without holder + FSB
1.6 Ti	77 - 88	04/10→						
HONDA - ACCORD IV Aerodeck (CB, CC) 09/89→02/94								
 Brake Pad Set, disc brake								
2.0 i 16V	98	03/93→12/93	➡			13.0460-5557.2	605557	AKE + WK + Zub
2.2	103	05/92→12/93						
2.2 i 16V	108 - 110	01/91→12/93						
HONDA - ACCORD IV Coupe (CB, CC) 05/89→12/93								
 Brake Pad Set, disc brake								
2.0 i 16V	98	01/92→09/93	➡			13.0460-5557.2	605557	AKE + WK + Zub
HONDA - ACCORD IV Sedan (CB) 11/89→12/93								
 Brake Pad Set, disc brake								
2.0 16V	66 - 81	01/90→03/93	➡	+ ABS		13.0460-5557.2	605557	AKE + WK + Zub
2.0 i 16V	98	01/90→03/93						
2.2	103	10/91→10/93	➡			13.0460-5557.2	605557	AKE + WK + Zub
2.2 i 16V	110	01/90→03/93						
2.2 i 16V Automatik	108	01/90→03/93						
HONDA - ACCORD V Aerodeck (CE) 04/93→02/98								
 Brake Pad Set, disc brake								
2.0 i LS 16V	100	09/93→02/98	➡	01/94→ 01/98		13.0460-5557.2	605557	AKE + WK + Zub
2.2 i ES	110	09/93→02/98						
HONDA - ACCORD V Coupe (CD) 04/93→12/98								
 Brake Pad Set, disc brake								
2.0	100	09/93→12/97	➡	01/94→		13.0460-5557.2	605557	AKE + WK + Zub
2.2 i ES	110	09/93→02/98	➡	01/94→ 01/98		13.0460-5557.2	605557	AKE + WK + Zub
HONDA - ACCORD V Sedan (CC, CD) 06/92→12/97								
 Brake Pad Set, disc brake								
2.0 i	85	03/93→01/96	➡	→ 12/95		13.0460-5557.2	605557	AKE + WK + Zub
			➡	01/94→		13.0460-5557.2	605557	AKE + WK + Zub
2.0 i S	96	03/93→01/96	➡	→ 12/95		13.0460-5557.2	605557	AKE + WK + Zub
2.3 i SR	116	03/93→01/96						
HONDA - ACCORD VI Coupe (CG) 12/97→06/03								
 Brake Pad Set, disc brake								
2.0	107	11/99→10/02	➡			13.0460-5557.2	605557	AKE + WK + Zub
2.0 i 16V	108	02/98→06/03						
3.0 V6 24V	147	02/98→06/03						
HONDA - ACCORD VI Sedan (CE, CF_, CD) 09/95→12/98								
 Brake Pad Set, disc brake								
1.9 i	85	02/96→10/98	➡	→ 09/98		13.0460-5557.2	605557	AKE + WK + Zub
2.0 i LS	96	02/96→10/98						
2.0 TDi	77	04/96→10/98						
2.2 i VTEC	110	02/96→10/98						













	kw					! #		
HONDA - ACCORD VI Sedan (CK, CG, CH, CF) 03/97→12/03								
 Brake Pad Set, disc brake								
2.3	110	03/97→01/99	➡			13.0460-5557.2	605557	AKE + WK + Zub
HONDA - CIVIC VI Aerodeck (MB, MC) 04/98→02/01								
 Brake Pad Set, disc brake								
1.4 16V	55 - 66	04/98→02/01	➡	01/99→; + ABS		13.0460-5557.2	605557	AKE + WK + Zub
1.5 16V	84	04/98→02/01	➡	+ ABS		13.0460-5557.2	605557	AKE + WK + Zub
1.6 16V	85	04/98→02/01	➡	01/99→		13.0460-5557.2	605557	AKE + WK + Zub
1.6 16V 1.8 16V	92 124	04/98→02/01 04/98→02/01	➡			13.0460-5557.2	605557	AKE + WK + Zub
HONDA - CIVIC VI Fastback (MA, MB) 09/94→02/01								
 Brake Pad Set, disc brake								
1.4 i 1.5 16V	55 84	09/95→02/01 01/97→02/01	➡	01/99→; + ABS		13.0460-5557.2	605557	AKE + WK + Zub
1.6 1.8 16V	92 124	11/98→02/01 01/97→02/01	➡			13.0460-5557.2	605557	AKE + WK + Zub
1.6 16V 1.6 VTi 2.0 i TD 2.0 TDiC	85 118 63 74 - 77	01/97→02/01 01/97→02/01 01/97→02/01 11/98→10/00	➡	01/99→		13.0460-5557.2	605557	AKE + WK + Zub
HONDA - CIVIC VI Hatchback (EJ, EK) 10/95→03/01								
 Brake Pad Set, disc brake								
1.5	66	11/95→12/96	➡	Number of Doors: 4		13.0460-5557.2	605557	AKE + WK + Zub
1.5 i	84	11/95→02/01	➡	→ 01/01; Number of Doors: 4		13.0460-5557.2	605557	AKE + WK + Zub
1.6	92	11/98→03/01	➡			13.0460-5557.2	605557	AKE + WK + Zub
2.0 TDiC	77	11/98→10/00	➡	01/99→		13.0460-5557.2	605557	AKE + WK + Zub
HONDA - CIVIC VI Saloon (EJ, EK, SO) 06/95→03/01								
 Brake Pad Set, disc brake								
1.5 i	84	11/95→02/01	➡	→ 01/01; Number of Doors: 4		13.0460-5557.2	605557	AKE + WK + Zub
HONDA - CIVIC VII Coupe (EM2) 02/01→12/05								
 Brake Pad Set, disc brake								
1.6 i	81	02/01→12/05	➡			13.0460-5557.2	605557	AKE + WK + Zub
			➡	→ 10/04		13.0460-5557.2	605557	AKE + WK + Zub
1.7 i 1.7 i VTEC	88 92	05/01→12/05 05/01→12/05	➡	→ 10/04		13.0460-5557.2	605557	AKE + WK + Zub
HONDA - CIVIC VII Hatchback (EU, EP, EV) 01/00→02/06								
 Brake Pad Set, disc brake								
1.4 i 1.6 i 1.7 CTDi 2.0 Type-R	55 81 74 147	02/01→09/05 02/01→09/05 01/02→09/05 09/01→09/05	➡			13.0460-5557.2	605557	AKE + WK + Zub
1.4 iS	66	11/00→09/05	➡	for left-hand drive vehicles		13.0460-5557.2	605557	AKE + WK + Zub
2.0 i Sport	118	09/01→09/05	➡	01/04→		13.0460-5557.2	605557	AKE + WK + Zub
HONDA - CIVIC VII Saloon (ES, ET) 10/00→04/06								
 Brake Pad Set, disc brake								
1.3 IMA 2.0	61 118	10/03→09/05 10/03→09/05	➡	01/04→		13.0460-5557.2	605557	AKE + WK + Zub
1.4	66	12/00→09/05	➡	02/01→		13.0460-5557.2	605557	AKE + WK + Zub
1.6 1.7	81 85	02/01→09/05 02/01→09/05	➡			13.0460-5557.2	605557	AKE + WK + Zub
HONDA - CIVIC VIII Saloon (FD, FA) 09/05→05/13								
 Brake Pad Set, disc brake								
1.3 1.3 IMA	85 70	02/06→12/12 01/06→12/12	➡	→ 02/12		13.0460-5557.2	605557	AKE + WK + Zub
1.3 IMA 1.6 →	82 - 85 84 - 92	09/05→02/12 09/05→12/12	➡			13.0460-5557.2	605557	AKE + WK + Zub















	kw					! #		
HONDA - CIVIC VIII Saloon (FD, FA) 09/05→05/13								
 Brake Pad Set, disc brake								
1.8	97 - 103	09/05→12/13	➔				13.0460-5557.2 605557	AKE + WK + Zub
1.8 EXS Flex	103	11/06→05/13	➔	→ 12/12			13.0460-5557.2 605557	AKE + WK + Zub
HONDA - CIVIC IX Saloon (FB) 09/11→12/16								
 Brake Pad Set, disc brake								
1.8	103 - 104	09/11→12/16	➔				13.0460-5557.2 605557	AKE + WK + Zub
HONDA - INSIGHT (ZE_) 04/09→								
 Brake Pad Set, disc brake								
1.3 IMA	65 - 73	04/09→	➔	→ 09/13			13.0460-5557.2 605557	AKE + WK + Zub
HONDA - INTEGRA Coupe (DC2, DC4) 07/93→11/01								
 Brake Pad Set, disc brake								
1.8	107	07/93→11/01	➔	11/97→ 10/01			13.0460-5557.2 605557	AKE + WK + Zub
1.8 Type-R	140	11/97→10/01	➔				13.0460-5557.2 605557	AKE + WK + Zub
1.8 Type-R	147	09/93→08/01	➔	11/97→			13.0460-5557.2 605557	AKE + WK + Zub
HONDA - INTEGRA Coupe (DC5) 08/01→								
 Brake Pad Set, disc brake								
2.0	118 - 147	02/02→	➔				13.0460-5557.2 605557	AKE + WK + Zub
2.0 16V Type-R	162	02/02→						
2.0 Type-S	154	10/04→04/07						
HONDA - JAZZ III (GE_, GG_, GP_, ZA_) 10/07→								
 Brake Pad Set, disc brake								
1.3 HYBRID	75	04/11→	➔	→ 12/15			13.0460-5557.2 605557	AKE + WK + Zub
HONDA - PRELUDE IV (BB_) 12/91→02/97								
 Brake Pad Set, disc brake								
2.0 i 16V	98	02/92→09/96	➔				13.0460-5557.2 605557	AKE + WK + Zub
2.2 i 16V Vtec	136	02/93→09/96						
2.3 i 16V	118	02/92→09/96						
HONDA - PRELUDE V (BB_) 10/96→12/01								
 Brake Pad Set, disc brake								
2.0 16V	98	10/96→10/00	➔				13.0460-5557.2 605557	AKE + WK + Zub
2.2 16V	136 - 147	10/96→12/01						
HONDA - S2000 (AP) 03/99→								
 Brake Pad Set, disc brake								
2.0	177	06/99→	➔				13.0460-5557.2 605557	AKE + WK + Zub
2.0 Vtec	170 - 184	03/99→						
2.2 Vtec	176	10/03→						
HYUNDAI - ACCENT V Saloon (HC) 01/17→								
 Brake Pad Set, disc brake								
1.4	73	07/18→	←				13.0470-5548.2 LD5548	MAN + WK + Zub Ceramic
1.6	97	01/18→						
1.6 CRDI	94	01/17→						
HYUNDAI - BAYON (BC3) 05/21→								
 Brake Pad Set, disc brake								
1.0 T-GDI	74	05/21→	←				13.0470-5548.2 LD5548	MAN + WK + Zub Ceramic
1.0 T-GDI 48V-Hybrid	74 - 88	05/21→						
1.2 LPG	62	05/23→						
1.2 MPI	62	05/21→						
1.4 MPI	74	05/21→						















	kW			 	! #		
HYUNDAI - i20 II (GB, IB) 11/14→							
 Brake Pad Set, disc brake							
1.0 T-GDI	74	01/16→	←			13.0470-5548.2 LD5548	MAN + WK + Zub Ceramic
	88						
1.1 CRDi	55	11/14→					
1.2	55	11/14→					
	62						
1.2 LPG	55	01/19→					
1.4	74	11/14→					
1.4 CRDi	66	11/14→					
HYUNDAI - i20 II Coupe (GB) 03/15→							
 Brake Pad Set, disc brake							
1.0 T-GDI	74	01/16→	←			13.0470-5548.2 LD5548	MAN + WK + Zub Ceramic
	88						
1.1 CRDi	55	05/15→					
1.2	62	05/15→					
1.4	74	05/15→					
1.4 CRDi	66	05/15→					
HYUNDAI - i20 II Hatchback Van (GB, IB) 11/14→							
 Brake Pad Set, disc brake							
1.0 T-GDi	74	01/16→	←			13.0470-5548.2 LD5548	MAN + WK + Zub Ceramic
	88						
1.1 CRDi	55	05/15→					
1.2 MPI	55	05/15→					
	62						
1.4 CRDi	66	05/15→					
1.4 MPi	74	05/15→					
HYUNDAI - i20 III (BC3, BI3) 08/20→							
 Brake Pad Set, disc brake							
1.0 T-GDI	74	08/20→	←			13.0470-5548.2 LD5548	MAN + WK + Zub Ceramic
	88						
1.0 T-GDI hybrid 48V	74	08/20→					
	88						
1.2	62	08/20→					
1.4 MPI	74	05/21→					
HYUNDAI - i20 ACTIVE (IB, GB) 09/15→							
 Brake Pad Set, disc brake							
1.0 T-GDI	74	09/15→	←	11/15→		13.0470-5548.2 LD5548	MAN + WK + Zub Ceramic
1.0 T-GDI	88	09/15→	←			13.0470-5548.2 LD5548	MAN + WK + Zub Ceramic
	74	09/15→					
1.4 CRDi	66	09/15→					
HYUNDAI - ix35 (LM, EL, ELH) 08/09→12/15							
 Brake Hose							
2.0	114	11/13→12/15	→	+ eFSB; ☐		24.5296-0390.3 331707	L= 420
2.0 AWD	114	11/13→12/15					
2.0 Flex	131	05/12→08/15					
HYUNDAI - SOLARIS Saloon (HCR) 01/17→							
 Brake Pad Set, disc brake							
1.4	74	01/17→	←			13.0470-5548.2 LD5548	MAN + WK + Zub Ceramic
	89	01/17→					
1.6	90						
HYUNDAI - TUCSON (TL, TLE) 05/15→12/20							
 Brake Hose							
1.6 CRDi	85	08/18→12/20	→	+ eFSB; ☐		24.5296-0390.3 331707	L= 420
	100						
1.6 CRDi All-wheel Drive	85	08/18→12/20					
	100						
1.6 CRDi hybrid 48V	85	03/19→12/20					
	100						
1.6 CRDi hybrid 48V All-wheel Drive	100	03/19→12/20					
1.6 GDi	96	06/15→09/20					
	97						
1.6 T-GDi	130	06/15→09/20					
1.6 T-GDi All-wheel Drive	130	06/15→09/20					
1.7 CRDi	85	06/15→09/20					
	104						
2.0	114	06/15→09/20					
	115						
→							













	kw			 	! #		
HYUNDAI - TUCSON (TL, TLE) 05/15→12/20							
 Brake Hose							
2.0 All-wheel Drive	114 - 115	06/15→09/20	➔	+ eFSB; ☐		24.5296-0390.3 331707	L= 420
2.0 CRDi	100 - 136	06/15→09/20					
2.0 CRDi All-wheel Drive	100 - 136	06/15→09/20					
2.0 CRDi Hybrid 48V All-wheel Drive	136	10/18→12/20					
2.0 CVVT	110	06/15→09/20					
2.0 CVVT All-wheel Drive	110	06/15→09/20					
2.0 GDi All-wheel Drive	122	09/15→09/20					
2.4 GDi All-wheel Drive	135	07/19→09/20					
HYUNDAI - TUCSON SUV Van (TLE) 05/15→12/20							
 Brake Hose							
1.6 CRDi	100	08/18→12/20	➔	+ eFSB; ☐		24.5296-0390.3 331707	L= 420
1.6 T-GDi	130	06/15→12/20					
KIA - RIO IV (YB, SC, FB) 01/17→							
 Brake Pad Set, disc brake							
1.0 T-GDi 100	74	01/17→	➔	Rim Size [inch]: 14		13.0470-5548.2 LD5548	MAN + WK + Zub Ceramic
1.0 T-GDi 100 Eco-Dynamics+	74	02/17→					
1.0 T-GDi 120	88	01/17→					
1.0 T-GDi 120 Eco-Dynamics+	88	02/17→					
1.25	62	01/17→					
1.25 LPG	60	07/20→					
1.2 CVVT	62	05/20→					
1.4	73 - 74	01/17→					
1.4 CRDi 77	57	01/17→					
1.4 CRDi 90	66	01/17→					
1.6	89 - 90	01/17→					
1.6 Flex	94	07/17→					
LPG	60	05/20→					
KIA - RIO IV Hatchback Van (YB, SC, FB) 01/17→							
 Brake Pad Set, disc brake							
1.0 T-GDi 100	74	01/17→	➔	Rim Size [inch]: 14		13.0470-5548.2 LD5548	MAN + WK + Zub Ceramic
1.0 T-GDi 120	88	01/17→					
KIA - RIO IV Saloon (SC, FB) 07/17→							
 Brake Pad Set, disc brake							
1.4	73 - 74	07/17→	➔	Rim Size [inch]: 14		13.0470-5548.2 LD5548	MAN + WK + Zub Ceramic
1.6	90	07/17→					
KIA - SPORTAGE IV (QL, QLE) 01/15→							
 Brake Hose							
1.6 CRDi	85 - 100	07/18→09/22	➔	+ eFSB; ☐		24.5296-0390.3 331707	L= 420
1.6 CRDi AWD	100	07/18→09/22					
1.6 CRDi Eco-Dynamics+	85 - 100	03/19→09/22					
1.6 CRDi Eco-Dynamics+ AWD	100	03/19→09/22					
1.6 GDI	97	09/15→09/22					
1.6 LPG	93	07/20→09/22					
1.6 T-GDi	130	09/15→09/22					
1.6 TGDI AWD	130	09/15→09/22					
1.7 CRDi	85 - 104	09/15→09/22					
2.0 CRDi	100	09/15→09/22					
2.0 CRDi Eco-Dynamics+ AWD	136	06/18→09/22					
2.0 AWD	114	12/15→09/22	➔	Vehicle Production Country Slovakia; + eFSB; ☐		24.5296-0390.3 331707	L= 420
2.0 CRDi	136	09/15→09/22					
2.0 CRDi AWD	100 - 136	09/15→09/22					

	kW			 	! #		
KIA - SPORTAGE IV VAN (QL, QLE) 09/15→							
 Brake Hose							
1.6 CRDI Eco-Dynamics+	100	03/19→	➔	+ eFSB; 		24.5296-0390.3 331707	L= 420
1.6 CRDI Eco-Dynamics+ All-wheel Drive	100	03/19→					
1.6 T-GDI	130	05/18→					
MERCEDES-BENZ - E-CLASS Convertible (A207) 01/10→12/16							
 Wheel Speed Sensor							
E 200	135	03/13→12/16	←	not for SA code: 800/801/802/803	2	24.0710-2140.3 360677	L= 705
E 220 BlueTEC	130	05/14→12/16					
E 250	155	06/13→12/16					
E 300	185	04/11→12/16					
E 320	200	07/14→12/16					
E 350	200 - 225	03/10→12/14					
E 350 BlueTEC/ d	190	05/14→12/16					
E 350 BlueTEC	185	06/13→12/16					
E 350 CDI	195	04/11→12/13					
E 350 CGI	215	01/10→12/14					
E 400	245	06/13→12/16					
E 500	300	09/11→12/16					
E 200 CGI	135	01/10→12/16	←	03/10→; not for SA code: 800/801/802/803	2	24.0710-2140.3 360677	L= 705
E 220 CDI / BlueTEC / d	125	01/10→12/16					
E 220 CDI	120	02/10→12/16					
E 250 CDI / BlueTEC / d	150	01/10→12/16					
E 250 CGI	150	01/10→12/16					
E 350 CDI	170	01/10→12/11					
E 500	285	01/10→12/11					
MERCEDES-BENZ - E-CLASS Coupe (C207) 01/09→12/16							
 Wheel Speed Sensor							
E 200	135	06/13→12/16	←	not for SA code: 800/801/802/803	2	24.0710-2140.3 360677	L= 705
E 200 CGI	135	01/10→12/16					
E 220 BlueTEC	130	05/14→12/16					
E 220 CDI / d	125	01/10→12/16					
E 250	155	06/13→12/16					
E 300	185	04/11→06/16					
E 320	200	07/14→12/16					
E 350	225	04/11→12/14					
E 350 BlueTEC / d	190	05/14→12/16					
E 350 BlueTEC	185	06/13→12/16					
E 350 CDI	195	06/11→06/13					
E 400	245	06/13→12/16					
E 500	300	09/11→12/16					
E 220 CDI	120	02/10→12/14	←	07/14→; not for SA code: 800/801/802/803	2	24.0710-2140.3 360677	L= 705
E 250 CDI / BlueTEC / d	150	01/09→12/16	←	05/09→; not for SA code: 800/801/802/803	2	24.0710-2140.3 360677	L= 705
E 250 CGI	150	01/09→12/16					
E 350 CDI	170	01/09→06/11					
E 350 CGI	215	01/09→12/11					
E 500	285	01/09→12/16					
E 350	200	01/10→12/11	←	05/11→; not for SA code: 800/801/802/803	2	24.0710-2140.3 360677	L= 705
MERCEDES-BENZ - eSPRINTER Van (B910) 02/20→							
 Brake Master Cylinder							
Electric	85	02/20→				24.2126-1708.3 011128	Ø 27 without brake fluid reservoir
MERCEDES-BENZ - SPRINTER 3,5-t Bus (B906) 06/06→							
 Brake Master Cylinder							
309 CDI	65	04/12→				24.2126-1708.3 011128	Ø 27 without brake fluid reservoir
311 CDI	84	05/16→					
313 CDI	95	08/11→05/16					
313 CDI 4x4	95	08/11→05/16					
314 CDI	105	05/16→					
314 CDI 4x4	105	05/16→					
315 CDI	110	06/13→					
316 CDI	120	08/11→					
316 CDI 4x4	120	08/11→					
310 CDI	70	03/09→12/13		10/09→		24.2126-1708.3 011128	Ø 27 without brake fluid reservoir
311 CDI	80	06/06→12/09					
311 CDI 4x4	80	02/08→12/09					
315 CDI	110	06/06→12/09					
315 CDI 4x4	110	02/08→12/09					
316	115	09/08→					
316 LGT	115	09/08→					
316 NGT	115	03/09→					















	kW			 	! #		
MERCEDES-BENZ - SPRINTER 3,5-t Bus (B906) 06/06→							
 Brake Master Cylinder							
318 CDI	135	02/08→12/09		10/09→		24.2126-1708.3 011128	Ø 27 without brake fluid reservoir
318 CDI 4x4	135	02/08→12/09					
319 CDI / BlueTEC	140	03/09→					
319 CDI / BlueTEC 4x4	140	03/09→					
324	190	06/06→12/13					
MERCEDES-BENZ - SPRINTER 3,5-t Platform/Chassis (B906) 06/06→							
 Brake Master Cylinder							
309 CDI	65	06/06→12/09		10/09→		24.2126-1708.3 011128	Ø 27 without brake fluid reservoir
310 CDI	70	03/09→05/16					
311 CDI	80	06/06→12/09					
311 CDI 4x4	80	02/08→12/09					
313 CDI	95	06/06→05/16					
313 CDI 4x4	95	06/06→05/16					
315 CDI	110	06/06→12/09					
315 CDI 4x4	110	02/08→12/09					
316	115	09/08→					
316 CDI	120	03/09→					
316 CDI 4x4	120	03/09→					
316 LGT	115	09/08→					
316 NGT	115	09/08→					
318 CDI	135	06/06→12/09					
318 CDI 4x4	135	02/08→12/09					
319 CDI / BlueTEC	140	03/09→					
324	190	06/06→12/13					
311 CDI	84	05/16→				24.2126-1708.3 011128	Ø 27 without brake fluid reservoir
314 CDI	105	05/16→					
314 CDI 4x4	105	05/16→					
319 CDI / BlueTEC 4x4	140	05/11→					
MERCEDES-BENZ - SPRINTER 3,5-t Platform/Chassis (B907, B910) 02/18→							
 Brake Master Cylinder							
311 CDI	84	02/18→				24.2126-1708.3 011128	Ø 27 without brake fluid reservoir
311 CDI RWD	84	02/18→					
314 CDI	105	02/18→					
314 CDI All-wheel Drive	105	01/19→					
314 CDI RWD	105	02/18→					
315 CDI	110	06/20→					
315 CDI RWD	110	06/20→					
316 CDI All-wheel Drive	120	01/19→					
316 CDI RWD	120	02/18→					
317 CDI	125	02/18→					
317 CDI RWD	125	06/20→					
318 CDI	130	02/18→					
319 CDI All-wheel Drive	140	01/19→					
319 CDI RWD	140	02/18→					
MERCEDES-BENZ - SPRINTER 3,5-t Tourer Bus (B907) 02/18→							
 Brake Master Cylinder							
311 CDI	84	02/18→				24.2126-1708.3 011128	Ø 27 without brake fluid reservoir
314 CDI	105	02/18→					
314 CDI All-wheel Drive	105	01/19→					
315 CDI	110	10/21→					
316 CDI	120	02/18→					
316 CDI All-wheel Drive	120	01/19→					
317 CDI	125	10/21→					
319 CDI	140	02/18→					
319 CDI All-wheel Drive	140	01/19→					
MERCEDES-BENZ - SPRINTER 3,5-t Van (B906) 06/06→							
 Brake Master Cylinder							
309 CDI	65	06/06→12/09		10/09→		24.2126-1708.3 011128	Ø 27 without brake fluid reservoir
310 CDI	70	03/09→					
311 CDI	80	06/06→12/09					
311 CDI 4x4	80	02/08→12/09					
313 CDI	95	06/06→					
313 CDI 4x4	95	05/09→					
315 CDI	110	06/06→12/09					
315 CDI 4x4	110	02/08→12/09					
316	115	09/08→					
316 CDI	120	03/09→					
316 CDI 4x4	120	03/09→					
316 LGT	115	09/08→					
316 NGT	115	09/08→					
318 CDI	135	06/06→12/09					
318 CDI 4x4	135	02/08→12/09					
319 CDI / BlueTEC	140	03/09→					
319 CDI / BlueTEC 4x4	140	03/09→					
324	190	06/06→12/13					
→							













	kw					! #		
MERCEDES-BENZ - SPRINTER 3,5-t Van (B906) 06/06→								
 Brake Master Cylinder								
311 CDI	84	05/16→				24.2126-1708.3	011128	Ø 27 without brake fluid reservoir
314 CDI	105	05/16→						
314 CDI 4x4	105	05/16→						
315 CDI	110	12/14→						
MERCEDES-BENZ - SPRINTER 3,5-t Van (B907, B910) 02/18→								
 Brake Master Cylinder								
311 CDI	84	02/18→				24.2126-1708.3	011128	Ø 27 without brake fluid reservoir
311 CDI RWD	84	02/18→						
314 CDI	105	02/18→						
314 CDI All-wheel Drive	105	01/19→						
314 CDI RWD	105	02/18→						
315 CDI	110	10/21→						
315 CDI RWD	110	06/20→						
316 CDI All-wheel Drive	120	01/19→						
316 CDI RWD	120	02/18→						
317 CDI	125	03/22→						
317 CDI RWD	125	06/20→						
319 CDI All-wheel Drive	140	01/19→						
319 CDI RWD	140	02/18→						
MERCEDES-BENZ - SPRINTER 3-t Bus (B906) 06/06→								
 Brake Master Cylinder								
209 CDI	65	04/12→				24.2126-1708.3	011128	Ø 27 without brake fluid reservoir
211 CDI	84	04/16→						
214 CDI	105	04/16→						
218 CDI	135	04/12→						
210 CDI	70	03/09→12/13		10/09→		24.2126-1708.3	011128	Ø 27 without brake fluid reservoir
211 CDI	80	06/06→12/09						
213 CDI	95	06/06→05/16						
215 CDI	110	06/06→12/09						
216	115	09/08→						
216 CDI	120	06/06→						
224	190	06/06→12/13						
MERCEDES-BENZ - SPRINTER 3-t Platform/Chassis (B906) 06/06→								
 Brake Master Cylinder								
209 CDI	65	06/06→12/09		10/09→		24.2126-1708.3	011128	Ø 27 without brake fluid reservoir
210 CDI	70	03/09→05/16						
211 CDI	80	06/06→12/09						
213 CDI	95	06/06→05/16						
215 CDI	110	06/06→12/09						
216	115	09/08→05/16						
216 CDI	120	03/09→						
218 CDI	135	06/06→12/09						
219 CDI / BlueTEC	140	03/09→05/16						
224	190	06/06→12/13						
211 CDI	84	04/16→				24.2126-1708.3	011128	Ø 27 without brake fluid reservoir
214 CDI	105	04/16→						
MERCEDES-BENZ - SPRINTER 3-t Platform/Chassis (B910, B907) 02/18→								
 Brake Master Cylinder								
211 CDI	84	02/18→				24.2126-1708.3	011128	Ø 27 without brake fluid reservoir
211 CDI RWD	84	02/18→						
214 CDI	105	02/18→						
214 CDI RWD	105	02/18→						
215 CDI	110	10/21→						
215 CDI RWD	110	06/20→						
216 CDI RWD	120	02/18→						
217 CDI RWD	125	06/20→						
MERCEDES-BENZ - SPRINTER 3-t Tourer Bus (B907) 02/18→								
 Brake Master Cylinder								
211 CDI	84	02/18→				24.2126-1708.3	011128	Ø 27 without brake fluid reservoir
214 CDI	105	02/18→						
215 CDI	110	10/21→						
217 CDI	125	10/21→						
MERCEDES-BENZ - SPRINTER 3-t Van (B906) 06/06→								
 Brake Master Cylinder								
209 CDI	65	06/06→12/09		10/09→		24.2126-1708.3	011128	Ø 27 without brake fluid reservoir
210 CDI	70	03/09→						
211 CDI	80	06/06→12/09						
213 CDI	95	06/06→						
215 CDI	110	06/06→12/09						
216	115	09/08→						
→								













	kW			 	! #		
MERCEDES-BENZ - SPRINTER 3-t Van (B906) 06/06→							
 Brake Master Cylinder							
216 CDI	120	03/09→		10/09→		24.2126-1708.3 011128	Ø 27 without brake fluid reservoir
218 CDI	135	06/06→12/09					
219 CDI / BlueTEC	140	03/09→					
224	190	06/06→					
211 CDI	84	04/16→				24.2126-1708.3 011128	Ø 27 without brake fluid reservoir
214 CDI	105	04/16→					
MERCEDES-BENZ - SPRINTER 3-t Van (B910) 02/18→							
 Brake Master Cylinder							
211 CDI	84	02/18→				24.2126-1708.3 011128	Ø 27 without brake fluid reservoir
214 CDI	105	02/18→					
215 CDI	110	10/21→					
MERCEDES-BENZ - SPRINTER 4,6-t Platform/Chassis (B906) 06/06→							
 Brake Master Cylinder							
411 CDI	80	06/09→12/18		10/09→		24.2126-1708.3 011128	Ø 27 without brake fluid reservoir
413 CDI	95	03/09→					
415 CDI	110	06/06→12/09					
416 CDI	120	03/09→					
418 CDI	135	06/06→12/09					
419 CDI	140	03/09→					
424	190	06/06→12/13					
411 CDI	84	04/16→				24.2126-1708.3 011128	Ø 27 without brake fluid reservoir
414 CDI	105	05/16→					
415 CDI	110	01/12→					
MERCEDES-BENZ - SPRINTER 4,6-t Van (B906) 06/06→							
 Brake Master Cylinder							
411 CDI	80	06/09→12/18		10/09→		24.2126-1708.3 011128	Ø 27 without brake fluid reservoir
413 CDI	95	06/06→05/16					
415 CDI	110	06/09→12/09					
416 CDI	120	03/09→					
418 CDI	135	06/09→05/16					
419 CDI	140	03/09→					
424	190	06/06→12/13					
411 CDI	84	04/16→				24.2126-1708.3 011128	Ø 27 without brake fluid reservoir
414 CDI	105	05/16→					
414 CDI 4x4	105	05/16→					
416 CDI 4x4	120	11/13→					
MERCEDES-BENZ - SPRINTER 4-t Platform/Chassis (B907, B910) 02/18→							
 Brake Master Cylinder							
411 CDI	84	02/18→				24.2126-1708.3 011128	Ø 27 without brake fluid reservoir
411 CDI RWD	84	02/18→					
414 CDI	105	02/18→					
414 CDI All-wheel Drive	105	01/19→					
414 CDI RWD	105	02/18→					
415 CDI	110	06/20→					
415 CDI RWD	110	10/21→					
416 CDI All-wheel Drive	120	01/19→					
416 CDI RWD	120	02/18→					
417 CDI	125	02/18→					
417 CDI RWD	125	10/21→					
418 CDI	130	02/18→					
419 CDI All-wheel Drive	140	01/19→					
419 CDI RWD	140	02/18→					
MERCEDES-BENZ - SPRINTER 4-t Tourer Bus (B907) 02/18→							
 Brake Master Cylinder							
411 CDI	84	02/18→				24.2126-1708.3 011128	Ø 27 without brake fluid reservoir
414 CDI	105	09/19→					
419 CDI	140	02/18→					
MERCEDES-BENZ - SPRINTER 4-t Van (B907, B910) 02/18→							
 Brake Master Cylinder							
411 CDI	84	02/18→				24.2126-1708.3 011128	Ø 27 without brake fluid reservoir
411 CDI RWD	84	02/18→					
414 CDI	105	02/18→					
414 CDI All-wheel Drive	105	01/19→					
414 CDI RWD	105	02/18→					
415 CDI	110	10/21→					
415 CDI RWD	110	10/21→					
416 CDI All-wheel Drive	120	01/19→					
416 CDI RWD	120	02/18→					
417 CDI RWD	125	06/20→					
419 CDI All-wheel Drive	140	01/19→					
419 CDI RWD	140	02/18→					















	kw			 	! #		
MERCEDES-BENZ - SPRINTER 5-t Bus (B906) 06/06→							
 Brake Master Cylinder							
513 CDI	95	03/09→		10/09→		24.2126-1708.3 011128	Ø 27 without brake fluid reservoir
515 CDI	110	06/06→					
516 CDI	120	03/09→					
519 CDI	140	03/09→					
MERCEDES-BENZ - SPRINTER 5-t Platform/Chassis (B906) 06/06→							
 Brake Master Cylinder							
509 CDI	65	06/06→12/09		10/09→		24.2126-1708.3 011128	Ø 27 without brake fluid reservoir
510 CDI	70	03/09→					
511 CDI	80	06/06→12/09					
511 CDI 4x4	80	06/06→12/09					
513 CDI	95	06/06→05/16					
515 CDI	110	06/06→12/09					
515 CDI 4x4	110	06/06→12/09					
516	115	09/08→					
516 CDI	120	03/09→					
516 NGT	115	09/08→					
518 CDI	135	06/06→12/09					
518 CDI 4x4	135	06/06→12/09					
519 CDI / BlueTEC	140	03/09→					
519 CDI / BlueTEC 4x4	140	03/09→					
524	190	06/06→12/13					
511 CDI	84	05/16→				24.2126-1708.3 011128	Ø 27 without brake fluid reservoir
513 CDI 4x4	95	05/11→05/16					
514 CDI	105	05/16→					
514 CDI 4x4	105	05/16→					
515 CDI	110	06/11→					
516 CDI 4x4	120	05/11→					
MERCEDES-BENZ - SPRINTER 5-t Platform/Chassis (B907) 02/18→							
 Brake Master Cylinder							
511 CDI	84	02/18→				24.2126-1708.3 011128	Ø 27 without brake fluid reservoir
514 CDI	105	02/18→					
515 CDI RWD	110	10/21→					
516 CDI	120	02/18→					
516 CDI All-wheel Drive	120	01/19→					
519 CDI	140	02/18→					
519 CDI All-wheel Drive	140	01/19→					
519 CDI RWD	140	10/21→					
MERCEDES-BENZ - SPRINTER 5-t Van (B906) 06/06→							
 Brake Master Cylinder							
509 CDI	65	06/06→12/09		10/09→		24.2126-1708.3 011128	Ø 27 without brake fluid reservoir
510 CDI	70	03/09→05/16					
511 CDI	80	06/06→12/09					
511 CDI 4x4	80	06/06→12/09					
513 CDI	95	06/06→					
513 CDI 4x4	95	06/06→					
515 CDI	110	06/06→12/09					
515 CDI 4x4	110	06/06→12/09					
516	115	03/09→					
516 CDI	120	03/09→					
516 CDI 4x4	120	06/06→					
516 NGT	115	03/09→					
518 CDI	135	06/06→12/09					
518 CDI 4x4	135	06/06→12/09					
519 CDI / BlueTEC	140	03/09→					
519 CDI / BlueTEC 4x4	140	03/09→					
524	190	06/06→12/13					
511 CDI	84	05/16→				24.2126-1708.3 011128	Ø 27 without brake fluid reservoir
514 CDI	105	05/16→					
514 CDI 4x4	105	05/16→					
515 CDI	110	06/11→					
MERCEDES-BENZ - SPRINTER 5-t Van (B907) 02/18→							
 Brake Master Cylinder							
511 CDI	84	02/18→				24.2126-1708.3 011128	Ø 27 without brake fluid reservoir
514 CDI	105	02/18→					
515 CDI	110	10/21→					
516 CDI	120	02/18→					
516 CDI All-wheel Drive	120	01/19→					
517 CDI	125	06/20→					
519 CDI	140	02/18→					
519 CDI All-wheel Drive	140	01/19→					
MG - EXPRESS Hatchback Van 03/03→05/05							
 Brake Pad Set, disc brake							
160	118	03/03→05/05	➔			13.0460-5557.2 605557	AKE + WK + Zub















	kw			 	! #		
MG - MG ZR 06/01→04/05							
 Brake Pad Set, disc brake							
160	118	06/01→04/05	➔			13.0460-5557.2 605557	AKE + WK + Zub
OPEL - MOKKA / MOKKA X (J13) 06/12→							
 Brake Master Cylinder							
1.4	88 - 103	04/13→		for left-hand drive vehicles		24.4123-1738.3 011124	Ø 23.8 without brake fluid reservoir
1.4 4x4	103 - 112	06/12→					
1.4 LPG	103	04/13→					
1.6	85	06/12→					
1.6 CDTI	81 - 100	01/15→					
1.6 CDTI 4x4	81 - 100	01/15→					
1.7 CDTI	96	06/12→					
1.7 CDTI 4x4	96	06/12→					
1.8	103	01/13→					
1.8 4x4	103	01/13→					
OPEL - MOKKA X VAN (J13) 06/12→							
 Brake Master Cylinder							
1.6 CDTI	100	03/18→		for left-hand drive vehicles		24.4123-1738.3 011124	Ø 23.8 without brake fluid reservoir
PORSCHE - 911 (991) 05/11→12/20							
 Brake Pad Set, disc brake							
3.0 Carrera	272	11/15→12/19	➔	for vehicles without ceramic brakes		13.0460-4712.2 604712	BRE + WE / - WK
3.0 Carrera 4	272	11/15→12/19					
3.0 Carrera 4 GTS	331	03/17→12/19					
3.0 Carrera 4S	309	11/15→12/19					
3.0 Carrera GTS	331	03/17→12/19					
3.0 Carrera S	309	11/15→12/19					
3.0 Carrera T	272	01/18→12/19					
3.4 Carrera	257	12/11→12/19					
PORSCHE - 911 Convertible (991) 03/12→05/20							
 Brake Pad Set, disc brake							
3.0 Carrera	272	11/15→12/19	➔	for vehicles without ceramic brakes		13.0460-4712.2 604712	BRE + WE / - WK
3.0 Carrera 4	272	11/15→12/19					
3.0 Carrera 4 GTS	331	03/17→12/19					
3.0 Carrera 4S	309	11/15→12/19					
3.0 Carrera GTS	331	03/17→12/19					
3.0 Carrera S	309	11/15→12/19					
3.4 Carrera	257	03/12→12/19					
3.4 Carrera 4	257	11/12→12/19					
3.8 Turbo	383 - 397	12/13→05/20					
PORSCHE - 911 Targa (991) 05/14→12/19							
 Brake Pad Set, disc brake							
3.0 Carrera 4	272	11/15→12/19	➔	for vehicles without ceramic brakes		13.0460-4712.2 604712	BRE + WE / - WK
3.0 Carrera 4 GTS	331	03/17→12/19					
3.0 Carrera 4S	309	11/15→12/19					
3.4 Carrera 4	257	05/14→12/19					
RENAULT - MODUS / GRAND MODUS (F/JPO_) 09/04→							
 Brake Hose							
1.2	48 - 76	12/04→	➔	→ 06/13; ☐		24.1294-0022.3 331699	L= 195 with pipe
1.2 16V	74	05/07→					
1.2 16V Hi-Flex	55	10/08→					
1.4	72	12/04→					
1.5 dCi	50 - 78	09/04→					
1.5 dCi 75	55	10/10→					
1.5 dCi 90	65	10/10→					
1.6	65 - 82	12/04→					
1.2 GPL	55	05/08→12/12	➔	☐		24.1294-0022.3 331699	L= 195 with pipe
ROVER - 600 I (RH) 08/93→10/00							
 Brake Pad Set, disc brake							
618 i/Si	85	03/96→02/99	➔			13.0460-5557.2 605557	AKE + WK + Zub
620 i	85	08/93→06/96					
→							

	kW			 	! #		
ROVER - 600 I (RH) 08/93→10/00							
 Brake Pad Set, disc brake							
620 Sdi 620 Si 620 Ti Vitesse 623 Si	77 96 147 116	05/94→06/99 08/93→02/99 05/94→08/98 08/93→06/99	➔			13.0460-5557.2 605557	AKE + WK + Zub
SEAT - LEON (5F1) 09/12→05/21							
 Brake Caliper							
1.0 TSI 1.2 TSI 1.4 TSI 1.6 TDI 1.8 TSI 2.0 Cupra 2.0 TDI	85 63 - 81 90 - 110 66 - 81 132 195 81 - 135	05/15→08/20 12/12→08/20 09/12→08/20 09/12→08/20 02/13→08/18 10/13→08/20 09/12→08/20	➔	+PR 1KW; ☐		24.3417-1722.5 241572	TRW without holder
1.4 TGI	81	02/13→08/18	➔	10/13→; +PR 1KW; ☐		24.3417-1722.5 241572	TRW without holder
SEAT - LEON Hatchback Van (5F1) 09/12→08/20							
 Brake Caliper							
1.0 TSI 1.2 TSI 1.4 TSI 1.6 TDI 1.8 TFSI 2.0 TDI	85 81 90 - 110 66 - 81 132 110 - 135	05/15→08/20 04/14→08/18 09/12→08/20 09/12→10/16 02/13→08/18 10/12→08/18	➔	+PR 1KW; ☐		24.3417-1722.5 241572	TRW without holder
1.2 TSI	63	01/13→08/18	➔	04/14→; +PR 1KW; ☐		24.3417-1722.5 241572	TRW without holder
SEAT - LEON SC (5F5) 01/13→12/18							
 Brake Caliper							
1.0 TSI 1.2 TSI 1.4 TSI 1.6 TDI 1.8 TSI 2.0 Cupra 2.0 TDI	85 63 - 81 90 - 110 66 - 81 132 195 81 - 135	05/15→08/18 01/13→08/18 02/13→08/18 02/13→08/18 02/13→08/18 10/13→11/16 02/13→08/18	➔	+PR 1KW; ☐		24.3417-1722.5 241572	TRW without holder
SEAT - LEON ST (5F8) 09/12→08/20							
 Brake Caliper							
1.0 TSI 1.2 TSI 1.4 TGI 1.4 TSI 1.6 TDI 1.6 TDI 4Drive 1.8 TSI 1.8 TSI 4Drive 2.0 Cupra 2.0 TDI 2.0 TDI 4Drive	85 63 - 81 81 90 - 110 66 - 81 77 - 81 132 132 195 81 - 135 110 - 135	05/15→08/20 08/13→08/20 10/13→08/18 09/12→08/20 09/13→08/20 04/14→08/20 10/13→08/18 11/14→08/18 10/13→08/20 02/13→08/20 04/14→08/20	➔	+PR 1KW; ☐		24.3417-1722.5 241572	TRW without holder
SEAT - LEON ST Estate Van (5F8) 01/13→08/20							
 Brake Caliper							
1.0 TSI 1.2 TSI 1.4 TSI 1.6 TDI 1.8 TFSI	85 63 - 81 110 81 132	05/15→08/20 01/13→08/18 05/14→08/20 09/13→08/20 10/13→08/18	➔	+PR 1KW; ☐		24.3417-1722.5 241572	TRW without holder

	kw			 	! #		
SEAT - LEON ST Estate Van (5F8) 01/13→08/20							
 Brake Caliper							
2.0 TDI	110 - 135	04/13→08/18	➡	+PR 1KW; ☐		24.3417-1722.5 241572	TRW without holder
2.0 TDI 4Drive	110	09/14→08/18					
2.0 TDI 4Drive	135	10/14→08/18	➡	11/14→; +PR 1KW; ☐		24.3417-1722.5 241572	TRW without holder
SKODA - OCTAVIA III (5E3, NL3, NR3) 11/12→03/21							
 Brake Caliper							
1.0 TSI	85	05/16→10/20	➡	+PR 1KW; ☐		24.3417-1722.5 241572	TRW without holder
1.2 TSI	81	05/15→02/17					
1.4 TSI	103	11/12→02/17					
1.4 TSI G-TEC	81	11/13→02/17					
1.5 TSI	110	02/17→10/20					
1.6	81	01/14→10/20					
1.6 TDI	81 - 85	05/13→10/20					
1.6 TDI 4x4	77 - 85	05/13→10/20					
1.8 TSI	132	11/12→10/20					
1.8 TSI 4x4	132	05/14→10/20					
2.0 TDI	105	11/12→02/17					
2.0 TDI 4x4	110	05/13→10/20					
2.0 TDI RS	135	05/13→10/20					
2.0 TSI	140	02/17→10/20					
2.0 TSI 4x4	140	02/19→10/20					
2.0 TSI RS	162 - 180	05/13→10/20					
1.2 TSI	63 - 77	11/12→02/17	➡	02/13→; +PR 1KW; ☐		24.3417-1722.5 241572	TRW without holder
1.6 TDI	66 - 77	11/12→10/20					
2.0 TDI	110	11/12→10/20					
1.4 TSI	110	08/14→10/20	➡	05/15→; +PR 1KW; ☐		24.3417-1722.5 241572	TRW without holder
2.0 TDI / TDI RS 4x4	135	05/13→10/20	➡	09/14→; +PR 1KW; ☐		24.3417-1722.5 241572	TRW without holder
SKODA - OCTAVIA III Combi (5E5, 5E6) 11/12→10/20							
 Brake Caliper							
1.0 TSI	85	05/16→10/20	➡	+PR 1KW; ☐		24.3417-1722.5 241572	TRW without holder
1.2 TSI	81	05/15→02/17					
1.4 TSI	103	11/12→02/17					
1.4 TSI G-TEC	81	11/12→02/17					
1.5 TSI	110	02/17→10/20					
1.5 TSI G-TEC	96	01/19→10/20					
1.6 SRE	81	01/14→02/17					
1.6 TDI	81 - 85	05/13→10/20					
1.6 TDI 4x4	77 - 85	11/12→10/20					
1.8 TSI	132	11/12→10/20					
1.8 TSI 4x4	132	11/12→02/17					
2.0 TDI	105	11/12→02/17					
2.0 TDI / TDI RS 4x4	135	05/13→10/20					
2.0 TDI 4x4	110	11/12→10/20					
2.0 TDI RS	135	05/13→10/20					
2.0 TSI	140	02/17→10/20					
2.0 TSI 4x4	140	02/19→10/20					
2.0 TSI RS	169 - 180	05/15→10/20					
1.2 TSI	63 - 77	11/12→02/17	➡	02/13→; +PR 1KW; ☐		24.3417-1722.5 241572	TRW without holder
1.6 TDI	66 - 77	11/12→10/20					
2.0 TDI	110	11/12→10/20					
1.4 TSI	110	08/14→10/20	➡	05/15→; +PR 1KW; ☐		24.3417-1722.5 241572	TRW without holder
2.0 TSI RS	162	11/12→02/17	➡	05/13→; +PR 1KW; ☐		24.3417-1722.5 241572	TRW without holder
SUZUKI - KIZASHI (FR) 10/10→							
 Brake Pad Set, disc brake							
2.4	131	10/10→	➡			13.0460-5557.2 605557	AKE + WK + Zub
2.4 4x4	131	10/10→					
2.4 LPG 4x4	131	01/14→12/14					
SUZUKI - SWIFT III (MZ, EZ) 02/05→							
 Brake Pad Set, disc brake							
1.6	92	05/06→	➡			13.0460-5557.2 605557	AKE + WK + Zub

	kw			 	! #		
SUZUKI - SX4 (EY, GY) 06/06→							
 Brake Pad Set, disc brake							
1.5 1.5 VVTi 1.6 VVT 1.6 VVT 4x4 2.0 16V 4x4 2.0 DDiS 2.0 DDiS 4x4	73 81 79 - 88 81 - 88 112 99 99	06/06→07/10 07/07→12/15 06/06→ 07/09→ 01/10→ 07/09→ 07/09→	➔	Vehicle Production Country Japan; + ABS		13.0460-5557.2 605557	AKE + WK + Zub
1.5 VVT 1.5 VVT 4x4 1.6 DDiS 1.6 LPG 1.6 VVT 4x4 1.9 DDiS 1.9 DDiS 4x4	82 82 66 79 79 88 88	07/10→ 07/10→ 04/07→ 06/06→12/12 06/06→ 06/06→ 06/06→	➔	+ ABS		13.0460-5557.2 605557	AKE + WK + Zub
2.0 4x4	107	06/06→	➔			13.0460-5557.2 605557	AKE + WK + Zub
SUZUKI - SX4 Saloon (GY, RW) 10/07→							
 Brake Pad Set, disc brake							
1.6 1.6 AWD	79 - 88 79	10/07→ 10/07→12/11	➔	Vehicle Production Country Japan; + ABS		13.0460-5557.2 605557	AKE + WK + Zub
VAUXHALL - MOKKA / MOKKA X (J13) 06/12→							
 Brake Master Cylinder							
1.4 1.4 4x4 1.6 1.6 CDTi 1.6 CDTi 1.6 CDTi 4x4 1.7 CDTi 1.7 CDTi 4x4	103 103 - 112 85 100 81 100 96 96	04/13→ 06/12→ 06/12→ 01/15→ 06/15→ 01/15→ 06/12→ 06/12→		for left-hand drive vehicles		24.4123-1738.3 011124	Ø 23.8 without brake fluid reservoir
VW - CRAFTER 30-35 Bus (2E_) 04/06→12/16							
 Brake Master Cylinder							
2.0 TDI 2.5 TDI	80 - 100 65 - 120	05/11→12/16 04/06→05/13		07/11→		24.2126-1708.3 011128	Ø 27 without brake fluid reservoir
2.0 TDI 2.0 TDI 4motion	84 - 120 120	07/11→12/16 11/11→12/16				24.2126-1708.3 011128	Ø 27 without brake fluid reservoir
VW - CRAFTER 30-50 Platform/Chassis (2F_) 04/06→12/16							
 Brake Master Cylinder							
2.0 TDI 2.5 TDI	80 - 100 65 - 120	05/11→12/16 04/06→05/13		07/11→		24.2126-1708.3 011128	Ø 27 without brake fluid reservoir
2.0 TDI 2.0 TDI 4motion	84 - 120 120	07/11→12/16 11/11→12/16				24.2126-1708.3 011128	Ø 27 without brake fluid reservoir
VW - CRAFTER 30-50 Van (2E_) 04/06→12/16							
 Brake Master Cylinder							
2.0 TDI 2.5 TDI	80 - 100 65 - 120	05/11→12/16 04/06→05/13		07/11→		24.2126-1708.3 011128	Ø 27 without brake fluid reservoir
2.0 TDI 2.0 TDI 4motion	84 - 120 120	07/11→12/16 07/11→12/16		11/11→		24.2126-1708.3 011128	Ø 27 without brake fluid reservoir
VW - CRAFTER Bus (SYI, SYJ) 09/16→							
 Brake Pad Set, disc brake							
2.0 TDI 2.0 TDI 4motion	75 - 130 103 - 130	09/16→ 03/17→	➔	+PR 1LC		13.0460-3895.2 603895	CBI + WE / - WK + Zub







	kW			 	! #		
VW - CRAFTER Platform/Chassis (SZ_) 11/16→							
 Brake Pad Set, disc brake							
2.0 TDI	75 - 130	11/16→	➔	+PR 1LC		13.0460-3895.2 603895	CBI + WE / - WK + Zub
2.0 TDI 4motion	103 - 130	03/17→					
2.0 TDI RWD	80 - 130	11/16→					
VW - CRAFTER Van (SY_, SX_) 09/16→							
 Brake Pad Set, disc brake							
2.0 TDI	75 - 130	09/16→	➔	+PR 1LC		13.0460-3895.2 603895	CBI + WE / - WK + Zub
2.0 TDI 4motion	103 - 130	03/17→					
2.0 TDI RWD	80 - 130	05/17→					
VW - GOLF VIII (CD1) 07/19→							
 Brake Pad Set, disc brake							
1.0 eTSI	81	06/20→	➔	+PR 1LK / 1LP / 1LM		13.0470-2654.2 LD2654	TRW + WK Ceramic
1.0 TSI	66 - 81	02/20→					
1.4 GTE Plug-in Hybrid	180	07/20→					
1.4 TSI eHybrid	150	07/20→					
1.5 eTSI	96 - 110	12/19→					
1.5 TGI	96	09/20→					
1.5 TSI	96 - 110	07/19→					
2.0 GTI	180	08/20→					
2.0 GTI Clubsport	221	10/20→					
2.0 TDI	85 - 110	08/19→					
2.0 TDI 4motion	110 - 147	09/20→					
2.0 TDI GTD	147	09/20→					
2.0 TSI	140	06/21→					
2.0 TSI 4motion	140	06/21→					
VW - GOLF VIII Variant (CG5) 08/20→							
 Brake Pad Set, disc brake							
1.0 eTSI	81	09/20→	➔	+PR 1LK / 1LP / 1LM		13.0470-2654.2 LD2654	TRW + WK Ceramic
1.0 TSI	66 - 81	08/20→					
1.5 eTSI	96 - 110	12/20→					
1.5 TGI	96	09/20→					
1.5 TSI	96 - 110	08/20→					
2.0 TDI	85 - 110	08/20→					
2.0 TDI 4motion	110	06/21→					
2.0 TSI	140	06/21→					
2.0 TSI 4motion	140	06/21→					
VW - GOLF ALLTRACK VIII (CG5) 11/20→							
 Brake Pad Set, disc brake							
2.0 TDI 4motion	147	11/20→	➔	+PR 1LK / 1LP		13.0470-2654.2 LD2654	TRW + WK Ceramic
VW - GRAND CALIFORNIA Camper (SCB, SCC) 04/19→							
 Brake Pad Set, disc brake							
2.0 TDI	103 - 130	04/19→	➔	+PR 1LC		13.0460-3895.2 603895	CBI + WE / - WK + Zub
2.0 TDI 4motion	103 - 130	04/19→					



- EN** Technical translations
- DE** Technische Übersetzungen
- ES** Traducciones técnicas
- FR** Traductions techniques
- IT** Traduzioni tecniche







Technical translations

Technische Übersetzungen - Traducciones tecnicas - Traductions techniques - Traduzioni tecniche

EN		EN	
	Brake Master Cylinder	Country specific package and status data	Country specific package and status data
	Brake Hose	- ESP	for vehicles without ESP
	Brake Caliper	External Thread 1 [mm]	External Thread 1 [mm]
	Brake Pad Set, disc brake	External Thread 2 [mm]	External Thread 2 [mm]
	Wheel Speed Sensor	Flange Hole Diameter [mm]	Flange Hole Diameter [mm]
	Rear Axle Left	for left-hand drive vehicles	for left-hand drive vehicles
	Rear Axle Right	for vehicles without ceramic brakes	for vehicles without ceramic brakes
+ ABS	for vehicles with ABS	Height [mm]	Height [mm]
+ eFSB	for vehicles with electric parking brake	Japan	Japan
+ ESP	for vehicles with ESP	L=	Length [mm]
+ FSB	Brake Caliper with integrated parking brake	L=	Warning Contact Length [mm]
+PR	for PR number	L1=	Length 1 [mm]
+ WE	prepared for wear indicator	L2=	Length 2 [mm]
+ WK	incl. wear warning contact with acoustic wear warning	MAN	Brake System, Mando
+ Zub	with accessories	not for SA code	not for SA code
Abfrage Produktbild vorhanden	Abfrage Produktbild vorhanden	Number of Doors	Number of Doors
AKE	Brake System, Akebono	Piston Diameter [mm]	Piston Diameter [mm]
Article number of recommended accessories	Article number of recommended accessories	Produkttyp vorhanden	Produkttyp vorhanden
ATE Ceramic	additional article information, ATE Ceramic	Reached Quality Gates	Reached Quality Gates
Brake Caliper Colour	Brake Caliper Colour	Red	Red
BRE	Brake System, Brembo	replacement part	replacement part
Cast Aluminium	Cast Aluminium	Rim Size [inch]	Rim Size [inch]

Technical translations

Technische Übersetzungen - Traducciones tecnicas - Traductions techniques - Traduzioni tecniche

EN		DE	
Service exchange part	Service exchange part		Hauptbremszylinder
Slovakia	Slovakia		Bremsschlauch
Spanner Size	Spanner Size		Bremssattel
Thickness [mm]	Thickness [mm]		Bremsbelagsatz, Scheibenbremse
TRW	Brake System, Lucas / TRW		Raddrehzahlsensor
Unreached Quality Gates	Unreached Quality Gates		Hinterachse links
usage number	usage number		Hinterachse rechts
Vehicle Production Country	Vehicle Production Country	+ ABS	für Fahrzeuge mit ABS
Width [mm]	Width [mm]	+ eFSB	für Fahrzeuge mit elektrischer Feststellbremse
with anti-squeak plate	with anti-squeak plate	+ ESP	für Fahrzeuge mit ESP
with brake caliper screws	with brake caliper screws	+ FSB	Bremssattel m. integr. Feststellbremse
without banjo bolt	without banjo bolt	+PR	für PR-Nummer
without brake fluid reservoir	without brake fluid reservoir	+ WE	für Verschleißwarnanzeiger vorbereitet
with pipe	with pipe	+ WK	inkl. Verschleißwarnkontakt mit akustischer Verschleißwarnung
- WK	excl. wear warning contact	+ Zub	mit Zubehör
x	Number of connectors	Abfrage Produktbild vorhanden	Abfrage Produktbild vorhanden
Yes	Yes	AKE	Bremssystem, Akebono
Ø	Diameter [mm]	Article number of recommended accessories	Artikelnummer des empfohlenen Zubehörs
→	Construction year from	ATE Ceramic	Artikelzusatzbezeichnung, ATE Ceramic
→	Construction year to	Brake Caliper Colour	Bremssattelfarbe
		BRE	Bremssystem, Brembo
		Cast Aluminium	Aluguss
		Country specific package and status data	Länderspezifische Verpackungs- und Status-Informationen







Technical translations

Technische Übersetzungen - Traducciones tecnicas - Traductions techniques - Traduzioni tecniche

DE		DE	
- ESP	für Fahrzeuge ohne ESP	Thickness [mm]	Dicke/Stärke [mm]
External Thread 1 [mm]	Außengewinde 1 [mm]	TRW	Bremssystem, Lucas / TRW
External Thread 2 [mm]	Außengewinde 2 [mm]	Unreached Quality Gates	Nicht erfüllte Qualitätsstufen
Flange Hole Diameter [mm]	Flanschlochdurchmesser [mm]	usage number	Gebrauchsnummer
for left-hand drive vehicles	für Linkslenker	Vehicle Production Country	Fahrzeugproduktionsland
for vehicles without ceramic brakes	für Fahrzeuge ohne Keramikbremse	Width [mm]	Breite [mm]
Height [mm]	Höhe [mm]	with anti-squeak plate	mit Anti-Quietsch-Blech
Japan	Japan	with brake caliper screws	mit Bremssattelschrauben
L=	Länge [mm]	without banjo bolt	ohne Hohlschraube
L=	Warnkontaktlänge [mm]	without brake fluid reservoir	ohne Bremsflüssigkeitsbehälter
L1=	Länge 1 [mm]	with pipe	mit Rohrleitung
L2=	Länge 2 [mm]	- WK	exkl. Verschleißwarnkontakt
MAN	Bremssystem, Mando	x	Anschlussanzahl
not for SA code	nicht für SA Code	Yes	Ja
Number of Doors	Türenanzahl	Ø	Durchmesser [mm]
Piston Diameter [mm]	Kolbendurchmesser [mm]	→	Baujahr ab
Produkttyp vorhanden	Produkttyp vorhanden	→	Baujahr bis
Reached Quality Gates	Erfüllte Qualitätsstufen		
Red	rot		
replacement part	Austauschteil		
Rim Size [inch]	Felgengröße [Zoll]		
Service exchange part	Austauschteil		
Slovakia	Slowakische Republik		
Spanner Size	Schlüsselweite		







Technical translations

Technische Übersetzungen - Traducciones técnicas - Traductions techniques - Traduzioni tecniche

ES		ES	
	Cilindro principal de freno	Country specific package and status data	Información específica del país sobre el embalaje y sobre el estado
	Tubo flexible de frenos	- ESP	para vehículos sin ESP
	Pinza de freno	External Thread 1 [mm]	Rosca exterior 1 [mm]
	Juego de pastillas de freno	External Thread 2 [mm]	Rosca exterior 2 [mm]
	Sensor de velocidad de la rueda	Flange Hole Diameter [mm]	Diám. taladro brida [mm]
	Eje trasero izquierda	for left-hand drive vehicles	para vehic. dirección izquierda
	Eje trasero, derecha	for vehicles without ceramic brakes	para vehículos sin frenos de cerámica
+ ABS	para vehículos con ABS	Height [mm]	Altura [mm]
+ eFSB	para vehículos con freno de estacionamiento electrónico	Japan	Japón
+ ESP	para vehículos con ESP	L=	Longitud [mm]
+ FSB	Pinza con freno estacionamiento integrado	L=	Longitud contacto de aviso [mm]
+ PR	Número de PR	L1=	Longitud 1 [mm]
+ WE	preparado para indicador desgaste	L2=	Longitud 2 [mm]
+ WK	con contacto avisador de desgaste con avisador acústico de desgaste	MAN	Sistema de frenos, Mando
+ Zub	con accesorios	not for SA code	no para código SA
Abfrage Produktbild vorhanden	Abfrage Produktbild vorhanden	Number of Doors	Número de puertas
AKE	Sistema de frenos, Akebono	Piston Diameter [mm]	Diámetro del pistón [mm]
Article number of recommended accessories	Nº art. de accesorio recomendado	Produkttyp vorhanden	Produkttyp vorhanden
ATE Ceramic	Denominación adicional del artículo, ATE Ceramic	Reached Quality Gates	Erfüllte Qualitätsstufen
Brake Caliper Colour	Color pinza freno	Red	rojo
BRE	Sistema de frenos, Brembo	replacement part	Recambio
Cast Aluminium	Fundición de aluminio	Rim Size [inch]	Tamaño de llanta [in]

Technical translations

Technische Übersetzungen - Traducciones técnicas - Traductions techniques - Traduzioni tecniche

ES		FR	
Service exchange part	Pieza de intercambio		Maître-cylindre de frein
Slovakia	República eslovaca		Flexible de frein
Spanner Size	Ancho de llave		Étrier de frein
Thickness [mm]	Espesor [mm]		Kit de plaquettes de frein, frein à disque
TRW	Sistema de frenos, Lucas / TRW		Capteur de vitesse de roue
Unreached Quality Gates	Nicht erfüllte Qualitätsstufen		Essieu arrière gauche
usage number	Número de uso		Essieu arrière droit
Vehicle Production Country	País producción vehículo	+ ABS	pour véhicules avec système antiblo-cage
Width [mm]	Ancho [mm]	+ eFSB	pour véhicules avec frein d'arrêt élec-trique
with anti-squeak plate	Chapa antichirridos	+ ESP	pour véhicules avec ESP
with brake caliper screws	con tornillos pinza freno	+ FSB	Étrier de frein avec frein de stationne-ment intégré
without banjo bolt	sin tornillo hueco	+PR	pour numéro PR
without brake fluid reser-voir	sin depósito líquido frenos	+ WE	préparé pour indicateur d'usure
with pipe	con tubo	+ WK	contact de signal d'usure inclu avec indicateur d'usure
- WK	excl. contacto de avisador de desgaste	+ Zub	avec accessoires
x	Número de conexiones	Abfrage Produktbild vorhanden	Abfrage Produktbild vorhanden
Yes	sí	AKE	Système de freinage, Akebono
Ø	Diámetro [mm]	Article number of recom-mended accessories	Référence de l'accessoire recommandé
→	año construcción desde	ATE Ceramic	Designation d'article complémentaire, ATE Ceramic
→	año construcción hasta	Brake Caliper Colour	Couleur de l'étrier
		BRE	Système de freinage, Brembo
		Cast Alumi-nium	Fonte d'aluminium

Technical translations







Technische Übersetzungen - Traducciones técnicas - Traductions techniques - Traduzioni tecniche

FR		FR	
Country specific package and status data	Informations d'emballage et d'état spécifiques aux pays	Service exchange part	Echange standard
- ESP	pour véhicules sans ESP	Slovakia	République slovaque
External Thread 1 [mm]	Filetage extérieur 1 [mm]	Spanner Size	Ouverture de la clé
External Thread 2 [mm]	Filetage extérieur 2 [mm]	Thickness [mm]	Épaisseur [mm]
Flange Hole Diameter [mm]	Diamètre du trou de bride [mm]	TRW	Système de freinage, Lucas / TRW
for left-hand drive vehicles	pour véhicules avec direction à gauche	Unreached Quality Gates	Nicht erfüllte Qualitätsstufen
for vehicles without ceramic brakes	pour véhicules sans frein en céramique	usage number	Numéro d'utilisation
Height [mm]	Hauteur [mm]	Vehicle Production Country	Pays constructeur du véhicule
Japan	Japon	Width [mm]	Largeur [mm]
L=	Longueur [mm]	with anti-squeak plate	avec tôle anti-bruit
L=	Longeur de contacts d'avertissement [mm]	with brake caliper screws	avec vis d'étrier de frein
L1=	Longueur 1 [mm]	without banjo bolt	sans vis creuse
L2=	Longueur 2 [mm]	without brake fluid reservoir	sans réservoir du liquide de frein
MAN	Système de freinage, Mando	with pipe	avec tuyau
not for SA code	pas pour SA code	- WK	contact de signal d'usure exclu
Number of Doors	Nombre de portes	x	Nombre de connexions
Piston Diameter [mm]	Diamètre du piston [mm]	Yes	Oui
Produkttyp vorhanden	Produkttyp vorhanden	Ø	Diamètre [mm]
Reached Quality Gates	Erfüllte Qualitätsstufen	→	Année à partir de
Red	rouge	→	Année jusqu'à
replacement part	Pièce de rechange		
Rim Size [inch]	Dimension de la jante [pouces]		



Technical translations

Technische Übersetzungen - Traducciones tecnicas - Traductions techniques - Traduzioni tecniche

IT		IT	
	Cilindro maestro del freno	Country specific package and status data	Informazioni di imballaggio e di stato specifiche per i diversi Paesi
	Flessibile del freno	- ESP	per veicoli senza ESP
	Pinza freno	External Thread 1 [mm]	Filetto esterno 1 [mm]
	Kit pastiglie freno, Freno a disco	External Thread 2 [mm]	Filetto esterno 2 [mm]
	Sensore velocità ruote	Flange Hole Diameter [mm]	Diametro foro flangia [mm]
	Assale posteriore Sx	for left-hand drive vehicles	per veicolo con guida a Sx
	Assale posteriore Dx	for vehicles without ceramic brakes	per veicoli senza freni in ceramica
+ ABS	per veicoli con ABS	Height [mm]	Altezza [mm]
+ eFSB	per veicoli con freno stazionamento elettrico	Japan	Giappone
+ ESP	per veicoli con ESP	L=	Lunghezza [mm]
+ FSB	Pinza freno con freno-stazionamento integrato	L=	Lunghezza contatti di segnalazione [mm]
+ PR	per N° PR	L1=	Lunghezza 1 [mm]
+ WE	Predisposto per contatto segnalazione usura	L2=	Lunghezza 2 [mm]
+ WK	Con contatto segnalazione usura con segnalatore acustico usura	MAN	Sistema frenante, Mando
+ Zub	con accessori	not for SA code	non per codice SA
Abfrage Produktbild vorhanden	Abfrage Produktbild vorhanden	Number of Doors	N° portiere
AKE	Sistema frenante, Akebono	Piston Diameter [mm]	Diametro pistone [mm]
Article number of recommended accessories	N° articolo accessorio consigliato	Produkttyp vorhanden	Produkttyp vorhanden
ATE Ceramic	Denominazione aggiuntiva dell'articolo, ATE Ceramic	Reached Quality Gates	Erfüllte Qualitätsstufen
Brake Caliper Colour	Colore pinza freno	Red	rosso
BRE	Sistema frenante, Brembo	replacement part	Ricambio di rotazione
Cast Aluminium	Alluminio pressofuso	Rim Size [inch]	Misura cerchione [pollici]

Technical translations

Technische Übersetzungen - Traducciones tecnicas - Traductions techniques - Traduzioni tecniche

IT	
Service exchange part	Ricambio di rotazione
Slovakia	Repubblica slovacca
Spanner Size	Apertura chiave
Thickness [mm]	Spessore [mm]
TRW	Sistema frenante, Lucas / TRW
Unreached Quality Gates	Nicht erfüllte Qualitätsstufen
usage number	Codice d'uso
Vehicle Production Country	Paese produzione veicolo
Width [mm]	Larghezza [mm]
with anti-squeak plate	con lamierino anticigolio
with brake caliper screws	con bulloni pinza freno
without banjo bolt	senza vite cava
without brake fluid reservoir	senza serbatoio liquido freni
with pipe	con tubazione
- WK	senza contatto segnalazione usura
x	N° raccordi
Yes	Sì
Ø	Diametro [mm]
→	Anno da
→	Anno fino a



ATE – A Trademark of the
Continental Corporation

**Continental Aftermarket &
Services GmbH**

Sodener Straße 9
D-65824 Schwalbach
Tel. +49 (0) 6196 87 0
Fax +49 (0) 6196 865 71

www.ate.de

**Continental Automotive Trading
Italia S.r.l.**

Via Matteotti, 62
I-20092 Cinisello Balsamo (MI)
Tel. +39 02 35680 1
Fax +39 02 35680 325
E-Mail: supporto@continental-corporation.com

www.ate-freni.it

**Continental Automotive Trading
France**

6 rue Jean Moulin
F-78120 Rambouillet
Tél. +33 (0)9 69 37 37 37

www.ate-freinage.fr

Continental Automotive Spain, S.A.

C/ Sepúlveda, 11
E-28108 Alcobendas (Madrid) Phone
+34 (0) 657 21 21
Fax +34 (0)91 657 21 49

www.frenos-ate.es